

CRUMAR[®]



Crumar Performer - Polyphonic analog String and Brass machine.

USER'S MANUAL

Version 1.0

www.crumar.it

INTRODUCTION

CRUMAR Performer – instrument background.

The Performer is a polyphonic analog strings and brass machine produced starting from 1979 by the Italian company "CRUMAR". It's a compact keyboard with 49 non dynamic-keys but fully polyphonic. The interface of the instrument is very simple and intuitive: just 15 sliders and 5 buttons.

The CRUMAR Performer is best remembered for its strings. An effective 3-band equalizer with high, mid and low sliders can be used to give the strings shimmering sparkle or moody dark timbres. The strings section uses two oscillators per voice with 8' and 16' settings. Simple Attack and Sustain sliders give you control of your string's envelope settings.

The Brass section uses a single oscillator with a square wave to generate the brass sound. It has a low-pass voltage-controlled filter with resonance. Attack and Decay sliders control its envelope settings. This section, in the Performer rev_B, uses the so-called SSM chips.

The LFO can modulate both Brass and String sections and can be routed either to the VCF or pitch.

The idea of CRUMAR Performer arrived after the success of the Multiman-S model (Orchestrator in USA), a fully polyphonic orchestral string machine, with five basic sounds: brass, piano, clavichord, cello and violin: all sounds are available at all times, just adjusting the volume of each section. It was released in 1977.

After few years, the company was enough smart to understand that the demand of musicians in 1979 was different and music was evolving differently in those days: requests were for smaller instruments with a more synthetic and less realistic brass sound, without piano and clavichord but still with string sounds, even if with a slightly different overall character.

Here came the CRUMAR Performer, a compact and more modern keyboard that seemed perfect for the music of the upcoming '80 and perfect for stage and live use. A keyboard with a mini-synth-brass section and an effective and modern string machine at an affordable price, making it a huge success and the king of '80 string machines, present in most important stages all over the world.

CRUMAR Performer – the electronic.

Performer, like many other keyboards, string machines and organs of the 70', uses the famous "TOS" configuration. This was a very common and practical way to achieve polyphony at that time: a high frequency clock drives a "top octave generator chip" ("tog" - top octave generator / "tos" - top octave synthesizer / "tod" - top octave divider) which produces all the note frequencies for the top octave as a basic square waves. These square waves can be then be fed to frequency dividers to produce a note an octave lower. The output of that divider can then be fed to another divider to get an octave below than that, and so on.

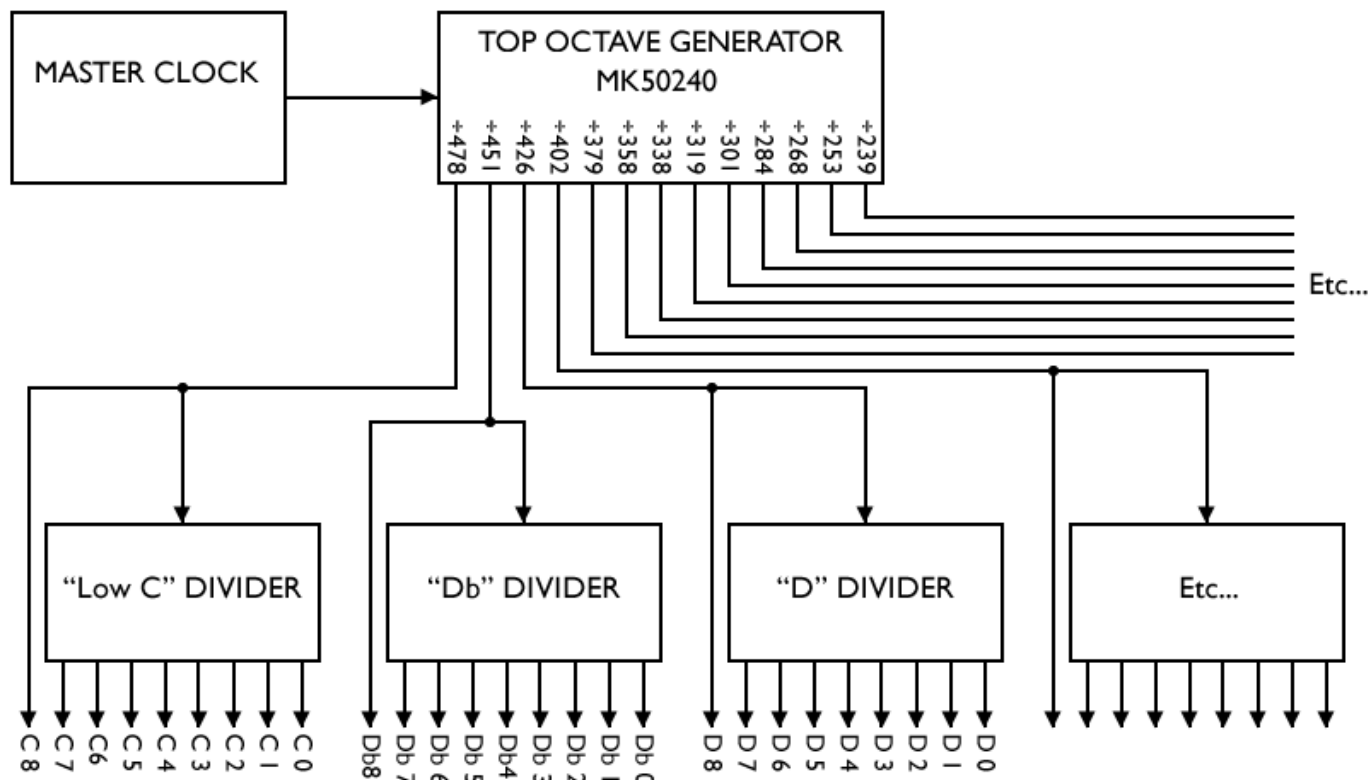

Performer used the Mostek MK50240N as a top octave synthesizer (another famous one was the S50240 from AMI) and used 12 TDA1008 as a frequency dividers to create a logical tonal grid according to which keys are being hit on the brass and 8' and 16' string mixes.

From here there's an analog filter/envelope on the brass and EQ and analog delay for the string section. Performer had 2 hardware revisions during production years basically with these differences:

Rev.A – First instrument release.

Rev.B – Added an extra transpose switch and boards revision. The brass section was completely redesigned using chips from SSM company (Solid State Micro Technology for Music): one SSM2050 IC as envelope generator and one SSM2040 IC as 4-pole filter. SSM2040 is considered one of the best sounding filters for the way it can add harmonics to the original signal, for its resonance and small amounts of distortion when overdriven.

Brass sound is para-phonic.

CRUMAR Performer – the software.

After more than 40 years since the release of the CRUMAR Performer keyboard, and after one year of accurate and intensive research on the original instruments, sound, components and schematics and all its variants, we decided to offer the same playing experience with an accurate software, a faithful replica of the original hardware instrument.

SOFTWARE INSTALLATION

SYSTEM REQUIREMENTS

Performer is available in the following formats:

- for Windows: VST2 x64, VST3 x64, Standalone x64
- for OSX: VST2 x64, VST3 x64, Audio Unit x64, Standalone x64

Windows:

- any Windows computer manufactured after 2010 running Windows 7 x64 or greater
- ASIO compatible sound card for low latency performance

OSX:

- OSX version 10.9 or greater

A MIDI controller keyboard to play CRUMAR Performer is suggested.

INSTALLATION ON WINDOWS

An automatic installer is provided. Double click its icon, accept the EULA and follow the on-screen instructions.

INSTALLATION ON OSX

An automatic installer is provided. Double click its icon, accept the EULA and follow the on-screen instructions. At some point you might be asked to insert your user's log-on password, this is required by OSX to authorize the copy of the files into your Library.

AUTHORIZING YOUR LICENSE

When the product is installed, it runs in DEMO mode so that you can test its sound and functionality, but with some minor limitations: the sound will go silent for a second every 15 seconds, and importing / exporting Programs and Banks won't be allowed.

If you have purchased a license, you can authorize your copy by doing copy & paste of the 24 characters license code into the registration screen.

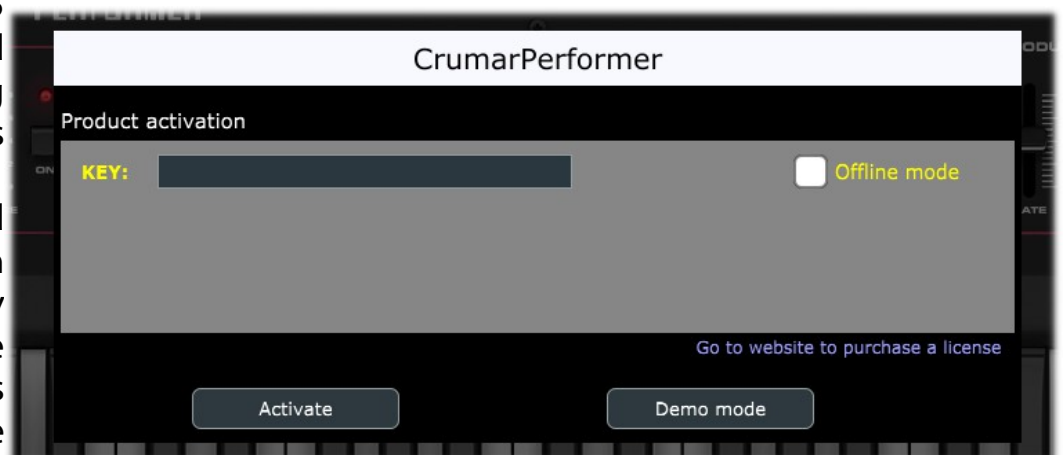

If the computer is connected to the Internet, just insert the license code and click REGISTER, the rest of the process is fully automatic. In case you wish to install CRUMAR Performer on a computer that isn't connected to the Internet, click the "Offline registration" option after inserting the license code, you'll be presented a numerical code in a read-only text box, copy that code somewhere (on paper or in a text file that you'll later save onto a USB stick), then go at a computer connected to the Internet, point your browser to <https://software.crumar.it/activate/> and follow the instructions. The basic personal license allows three installations; extra installations can be purchased separately. Please contact CRUMAR for this.

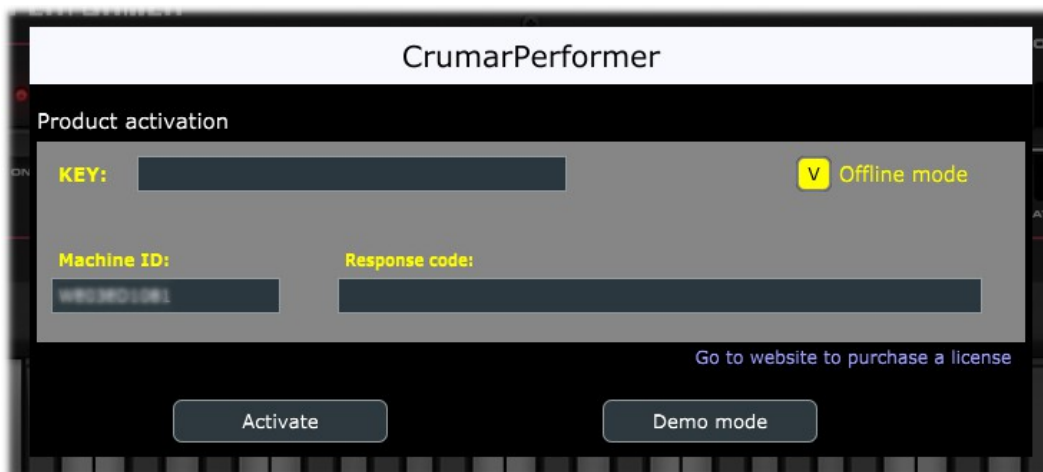

THE MAIN WINDOW

What you see on the main screen of CRUMAR Performer software is pretty much what you see when you are in front of a real one, with every little bit exactly where it belongs. Brass section on the left, central area dedicated to strings, on the right part you will find modulation section and main volume of the instrument. The panel of the instrument follows Performer rev.B, with the "transpose" switch.

First things to mention are the two buttons named "MAIN" and "EFFECTS". Yes, we decided to add an entire effects section that you will find more than useful! When "MAIN" is active, you will see the keyboard and its control panel, when the "EFFECT" is active, control panel will hide and you will be able to reach the effect section where you will find a 7-band eq, a phaser, a chorus/flanger and an analog delay.

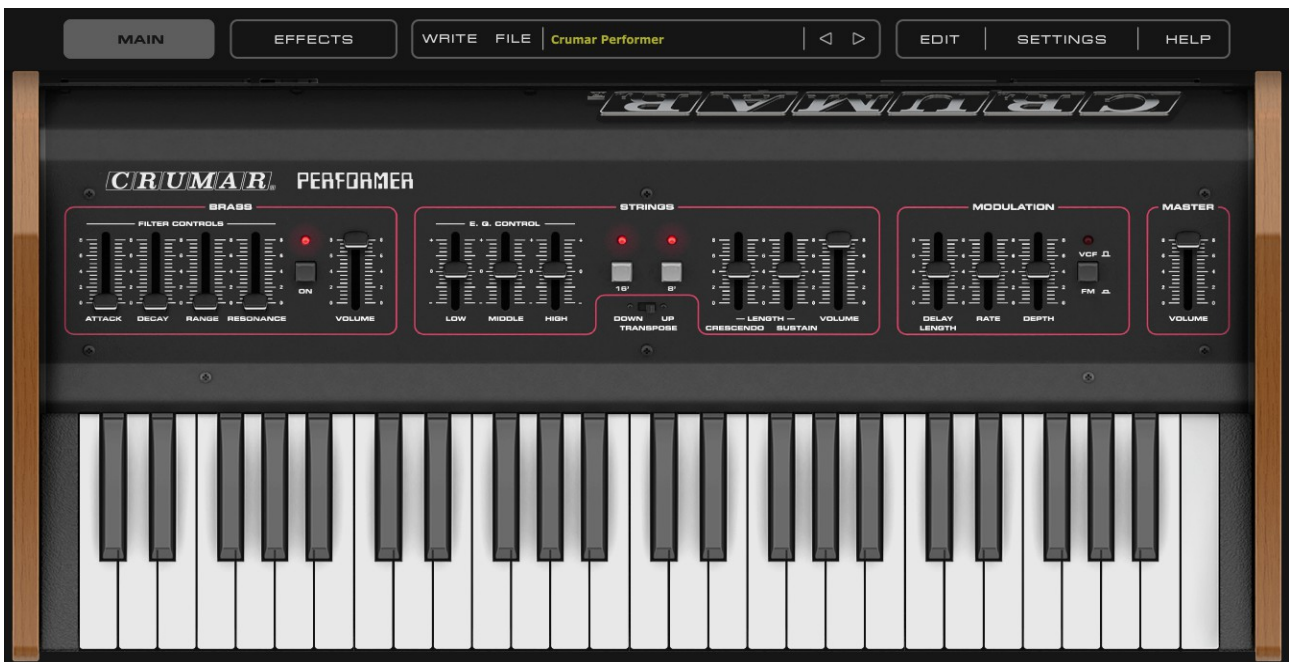

INSTRUMENT PANEL

-SWITCHES

The four switches or buttons found on your Performer are the on/off controls. By pushing the button in, the corresponding LED found on top of each switch will light up indicating the function is turned on.

-VOLUME SLIDES

On the front panel there are three slide controls marked "VOLUME". Moving left to right, they are the volume controls for the Brass section, the Violin section and the overall master volume. Collectively, these controls provide a simple mixing console for more accurate control of volume levels. Remember, the right master volume control must be kept on otherwise no sound will be heard. Use the two other slides for achieving the proper balance between the strings and the brass sounds.

-BRASS SECTION

The Brass section is activated by depressing the on/off position switch and moving the volume slide. A large variety of sounds are attained through manipulation of the four sliders found to the left of the volume control. The Attack and Decay sliders serve as envelope controllers. They provide the various nuances or subtleties needed when expressing a note. The Range and Resonance sliders control the overall sound quality. They function as the filter controllers. Although, each slider has an independent function, they all work together to produce sounds that range from French Horns to Synthesizer filter sweeps.

-STRING SECTION

To activate the string section, depress either the 16' or 8' foot switch. The 8' foot octave is considered a violin register, while the 16' foot can be used together to achieve a rich, full string section. The three equalization controls function as a three band graphic, coloring the entire range of string possibilities. They also serve as an excellent means of altering the string sounds directly from the keyboard. Most important, it gives the Performer a vast array of sound combinations ranging from very mellow types of strings sounds to those very bright. The higher the position, the greater the effect or interaction. By manipulating the low, mid and high sliders, you can achieve the string sound of your choice.

-CRESCENDO CONTROL

In the "0" position the strings will be heard immediately. By moving the slider upwards the attack time will be increased accordingly. This slide is always live, so take note of its position at all times since it will affect not only the sound of the strings, but their placement in the music.

-SUSTAIN SLIDE

This slide lengthens the time the note will sound after your hand is removed. In the "0" position, there will be no sustain and in the "8" position maximum sustain. (Note: the sustain feature is disabled or defeated when the brass button is depressed). A modification on the original circuit was possible in order to allow the sustain feature to be active even if the brass section was on. We added this feature in the software, find more details on page 11.

-TRANSDPOSE

With this selector, you can transpose the entire range of the keyboard up or down by one octave.

-MODULATION SECTION

The modulation section is always on and when the selector is in upper position, activated the V.C.F. Modulation, while in down position activates the Frequency modulation (F.M.). The LED serves as a visual monitor of the modulation rate. The V.C.F. modulation is routed into the filter and operates only in conjunction with the brass section.

Necessarily, the brass section must be turned on when operating these controls. The F.M. may be used with both brass and strings sections. The modulation effects are controlled by the depth and rate sliders. The delay slide determines how long after the key is depressed the preset effect will come in. The Resonance and Range controls in the filter bank have greatest effect on what types of modulation sounds will be achieved.

EFFECT VIEW

When the "EFFECT" view is active, you are able to see, activate and vary all the settings for each effect stomp-box.

Every effect pedal has a dedicated button to turn ON/OFF like the real ones.

The parameters present on each effect, reflect typical controls present on famous effect boxes used in those days; these were used a lot in combinations with string machines just to reach particular tones or to enrich the sound.

- Graphic Eq: 7-bands equalization pedal with volume control.
- Phaser: this is a great effect to use in combination with strings of your Performer. It's based on "all-pass" filters that vary audio signal, then passing thru a LFO and, in the end, 180° inverted, goes out together with original signal. This has a selection for 2 or 4 stages (2 or 4 all-pass filters) plus controls for Depth, Feedback, Rate and Modulation Offset.
- Chorus/Flanger: another effect useful to inject life into your Performer! This is based on delay lines, the original audio signal plus the delayed signal gradually changing period, the "comb filter". Rate, Depth and Feedback are the controls present on this effect. Typical and iconic effect of the '60 and '70 that recalls the roar of a propulsion jet passing by.
- Analog delay: this effect based on the so-called BBD (bucket-brigade device), was relatively new when CRUMAR Performer was released. It's based on a chip (normally TDA1022 or SAD-1024) able to store analog signals and move them along a line of capacitor one step at each. A clock can be applied to it in order to select the time. BBD chips are also used inside original CRUMAR Performer to create chorus. The analog delay pedal effect has controls for Level, Feedback (self-oscillation is possible at high levels), Delay time, Delay Modulation rates and Modulation depth.

THE PROGRAMMER

An interesting features of Performer is the programmer. This section allows to Write/ Recall user Programs, import / export single Programs or entire Banks, also copy & paste Programs from one location to another, or initialize the current Program for a fresh start.

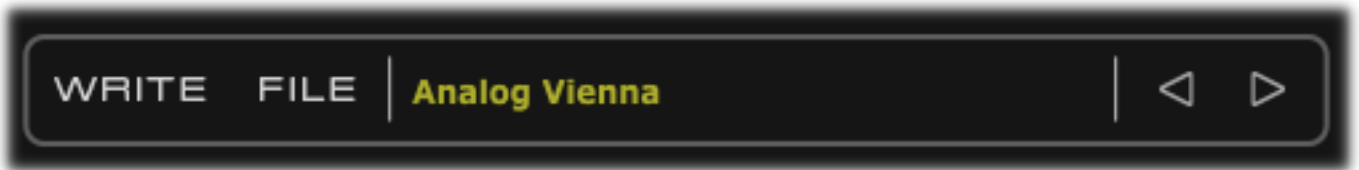

Each Bank consists of 128 Programs numbered from 0 to 127, like the good old MIDI protocol requires. To recall a Program, either use the UP / DOWN arrows on the left of the main display, or click on the Program name label for a full pop-up list of the 128 available Programs, or recall them from MIDI Program Change events (needs to be activated from the Settings Window).

To store a Program: once you're done with all your tweakings and you decide it's time to store the Program, just left-click the WRITE button and there you have 3 options: rename, overwrite or write to a different location.

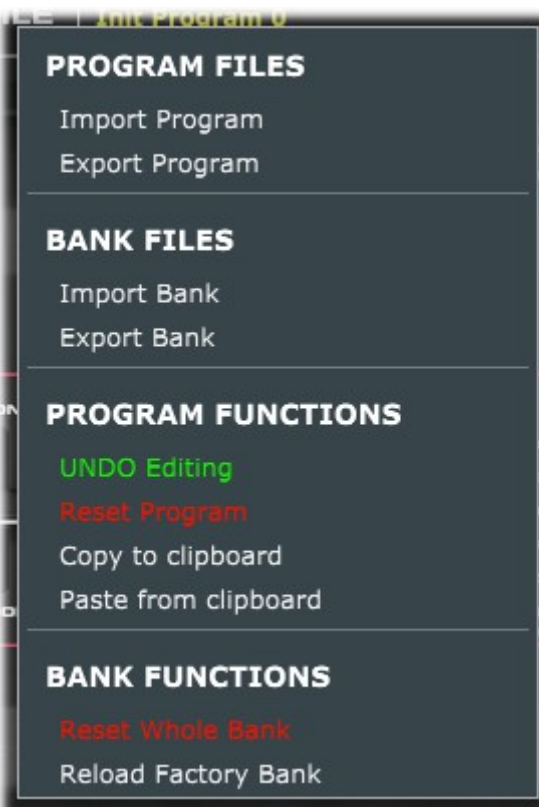
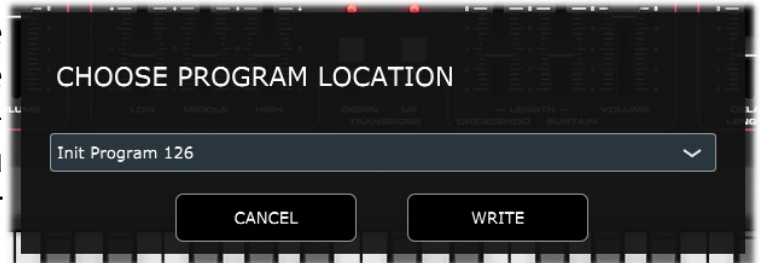

There are shortcut to these function: if you want to give it a new name, right-click the name label and type the new name, press <ENTER> to confirm; in this case, to confirm the operation and permanently store, don't forget to right-click WRITE button. If you like to simply overwrite the current Program just right-click the WRITE button.

Other operations with Programs and Banks can be performed from the FILES menu that you can access by clicking on the FILES button. Here you can import or export single Programs or entire Banks. Programs and Banks use a proprietary format and are saved in binary files with the extensions ..CrumarProgram and .CrumarBank, and the built-in bank is automatically saved every time a Program is written or the application / plugin is closed. The functions "Copy to clipboard" and "Paste from clipboard" can be used for reorganizing Programs in a Bank, and "Reset Program" recalls an initialized

program with default parameter settings. Operations such as import, reset or paste, that apparently overwrite the current program, actually use a temporary volatile memory that is lost unless the WRITE function is used. Lastly, it's also possible to reset the whole Bank or restore the factory Bank.

OPTIONS FOR THE STANDALONE APPLICATION

The standalone application offers an extra menu for setting the AUDIO and MIDI devices. Under Windows it is possible to select between the available audio driver types. For better performance, use a low-latency ASIO driver, possibly the most recent driver released from your sound-card's manufacturer. Select the stereo output port, the sampling rate, the buffer size, and the MIDI input device.

Performer supports sample-rates from 44100 up to 384000 with no internal re-sampling. However, the best performance is achieved at 44100.

The settings are immediately applied as soon as they're changed. Close this window when done.

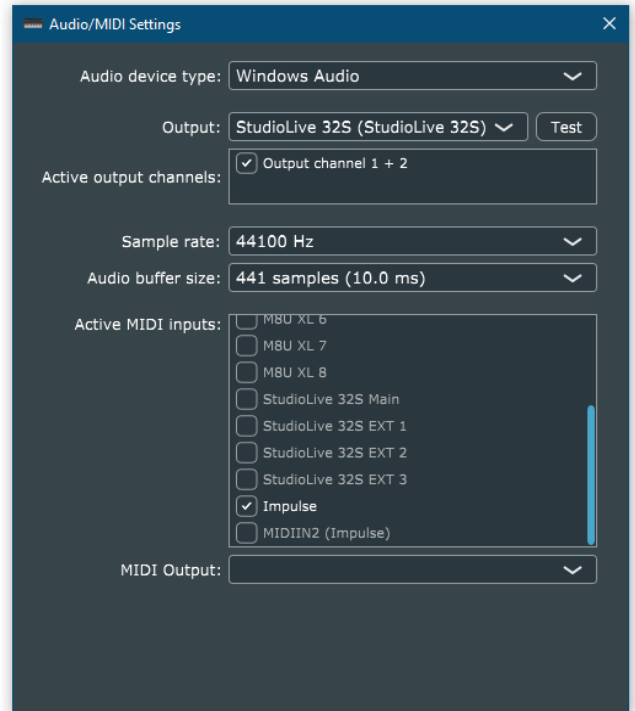

Please note: the standalone application always stores the last status, regardless of the Program that was selected the last time it was used.

SOUND EDITING, GLOBAL SETTINGS AND HELP

The buttons on the top right corner of the main screen are used to open the editing panels, the global settings in separate windows. The choice of using separate windows, rather than embedding everything in the main window, makes it easier to organize the work-space and facilitates the work-flow by offering a wide view of all editing possibilities at a glance.



THE EDIT WINDOW

In this section you will find few sound-related parameters that you can edit for your instrument. There you can also find settings for an added chorus and reverb. They consist in horizontal sliders that respond to a range values spanning from 0 to 127 or 0 to 1 in case they are on/off switches.

Stopping the mouse pointer on a control invokes a “tool tip window” with useful informations related to the parameter the mouse is on; a double-click on a slider knob recalls the previous value that was set the moment the window was open. Values can also be typed directly into the readout boxes.

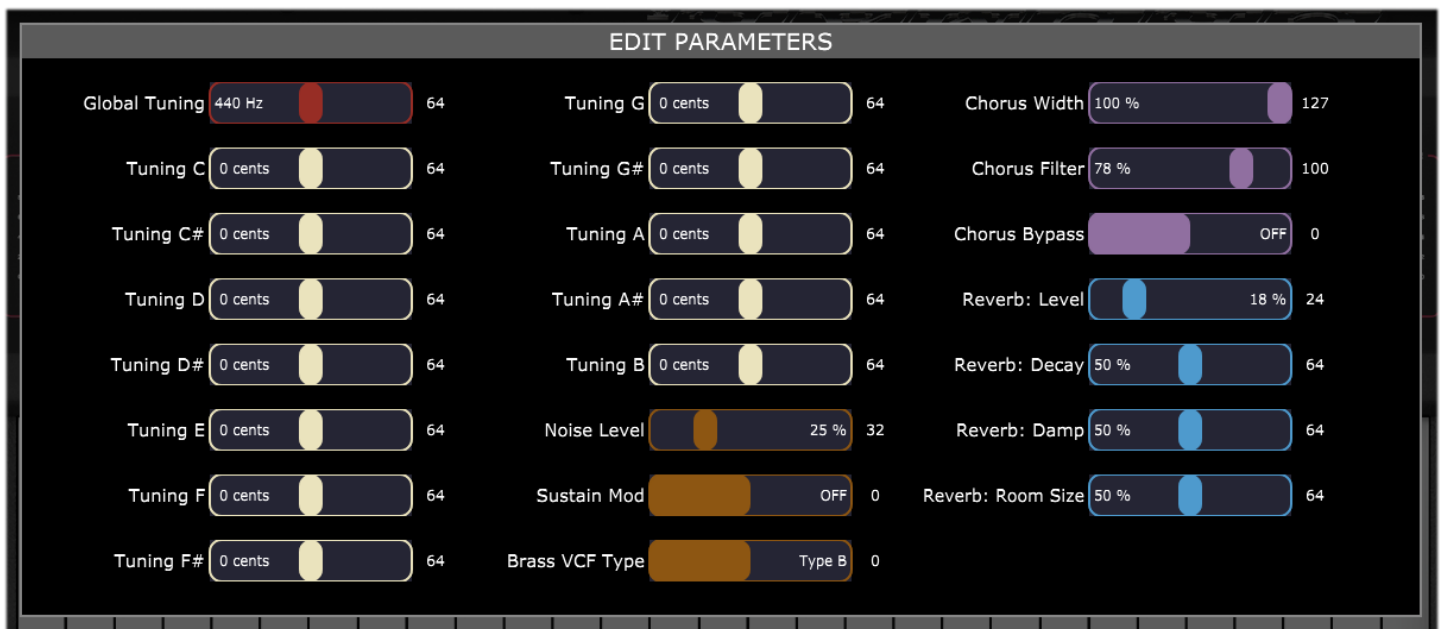

Brief explanation of all parameters:

- **Global Tuning:** set the base tuning from 392Hz to A=494 Hz. The original hardware instrument has a knob in the rear panel for this!
- **Tuning (12 sliders) :** this is something that wasn't possible on a real CRUMAR Performer. Like explaining in the introduction of this manual, the instrument is based on a chip called "TOS". This chip is in charge of creating all 12 frequencies used for all 12 musical notes following equal tempered scale just supplying it with a 2,00024Mhz clock. What you can do with this settings in the software, is detuning every single note of the top octave generator from -55 cents to +55 cents.
- **Noise Level:** this can be used to raise the amount of noise generated by the oscillator.
- **Sustain Mod:** When this slider is set to "ON", you can use the sustain feature even if the brass section is off.
- **Brass VCF Type:** selection for brass filter of Performer rev.A or Performer rev.B
- **Chorus Parameters:** this consists on 3 sliders, the first one (width) to control the amount of modulation, the second one (filter) to control the shape of the chorus filter, the third one is a bypass for it. Please note: Bypass filter is a function not present in the original instrument but CRUMAR Performer had a dedicated audio out jack for signal generated before the chorus circuitry.
- **Reverb parameters:** this consists on 4 sliders, the first one is the amount of digital reverb, second one is used to control the reverb decay, "damp" is used to adjust reverb timbre and the fourth one is the virtual size of the reverberation chamber. Please note: Reverb is a feature not present in the original instrument.

THE GLOBAL SETTINGS WINDOW

This panel shows the global settings that are stored in a separate file and affect the overall operation of Performer.

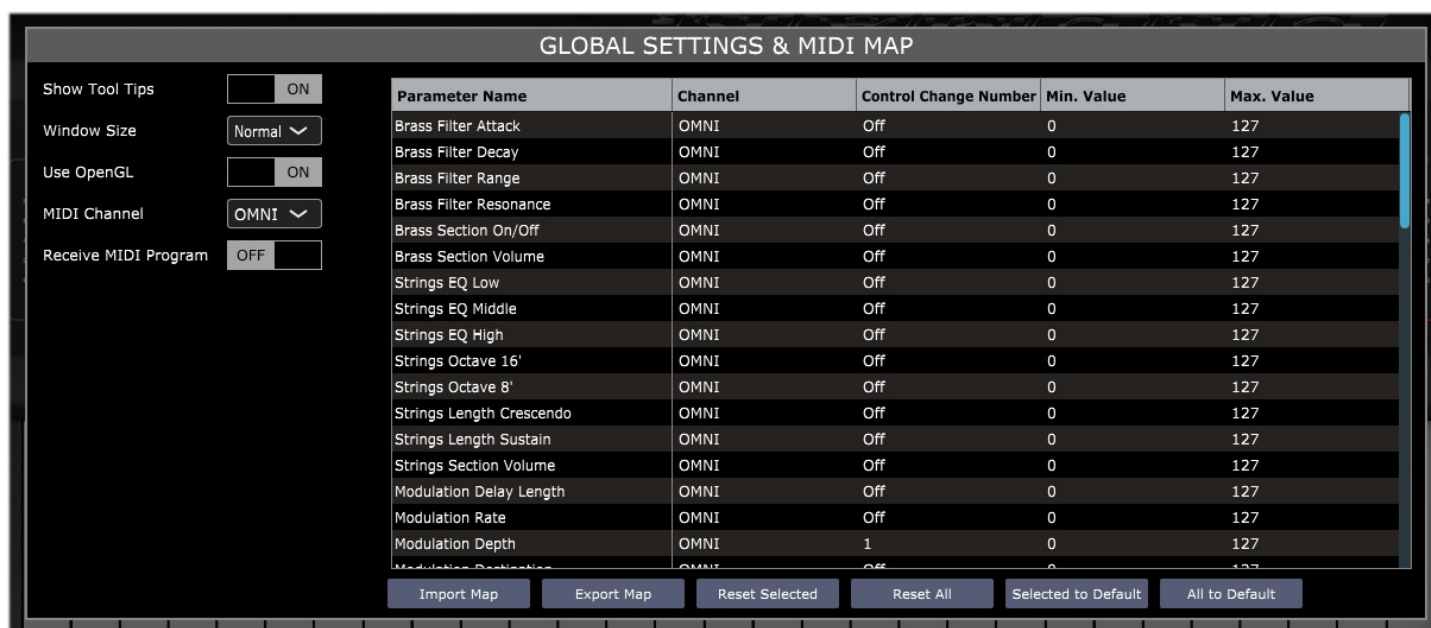

Settings are:

- **Show Tool Tips:** hide/show tool tips on all UI controls.
- **Window Size:** Adjust the size of Performer window: 5 different sizes are possible from "smaller" to "larger" to fit your screen and your need.
- **Use OpenGL:** Switch to "OFF" if you would like the Performer software to use CPU for graphic rather than OpenGL. Please note: this can affect the performance of your computer as well as the rendering to the Performer software animations.
- **MIDI CHANNEL:** Set this to "omni" if you would like the software to respond on all MIDI channels.
- **Receive MIDI program:** activate this if you wish to switch between Programs by sending MIDI Program Change events.

In this window you can see the entire MIDI map of your instrument: arranged in columns and row you can see the Parameter Name, MIDI channel, the number of Control Change assigned and you can also choose the minimum and maximum range from 0 to 127 when you are moving your physical control.

In the bottom of this windows, you will find 6 buttons used for files operations on the MIDI map as well as reset or reset to default selections for single parameter or entire map.

- **Import MAP:** clicking on this button will open a new windows where you can search and load a MIDI Map to use with your Performer.
- **Export Map:** clicking on this button will open a new windows where you can save your existing MIDI Map to a new file.
- **Reset Selected:** This is used to reset the actually selected parameter to its factory default. A confirmation windows will pop-up.
- **Reset All:** This is used to reset all MIDI Map its factory default. A confirmation windows will pop-up.
- **Selected to Default:** This is used to revert the actually selected parameter to the default value stored in the saved MIDI Map. A confirmation windows will pop-up.
- **All to Default:** This is used to revert all parameters to the default value stored in the saved MIDI Map. A confirmation windows will pop-up.

MIDI LEARN

Performer features an advanced MIDI “Learn” system for helping with mapping MIDI CC messages to the parameters. By default, all “performance” parameters are empty, but it's very easy to change the assignments to fulfill different requirements.

Right click on any parameter on the interface (also in the separate editing windows) to access the MIDI Learn menu.

Click on “Start MIDI Learn” to start learning the MIDI parameters coming from your controller.

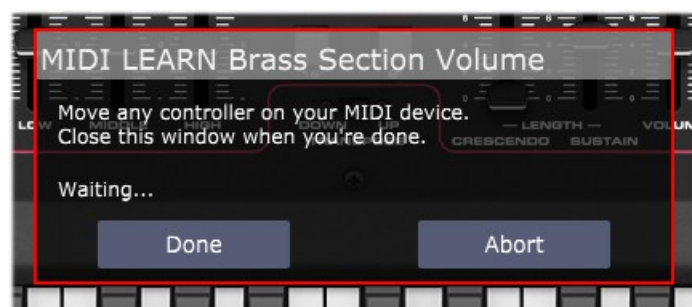
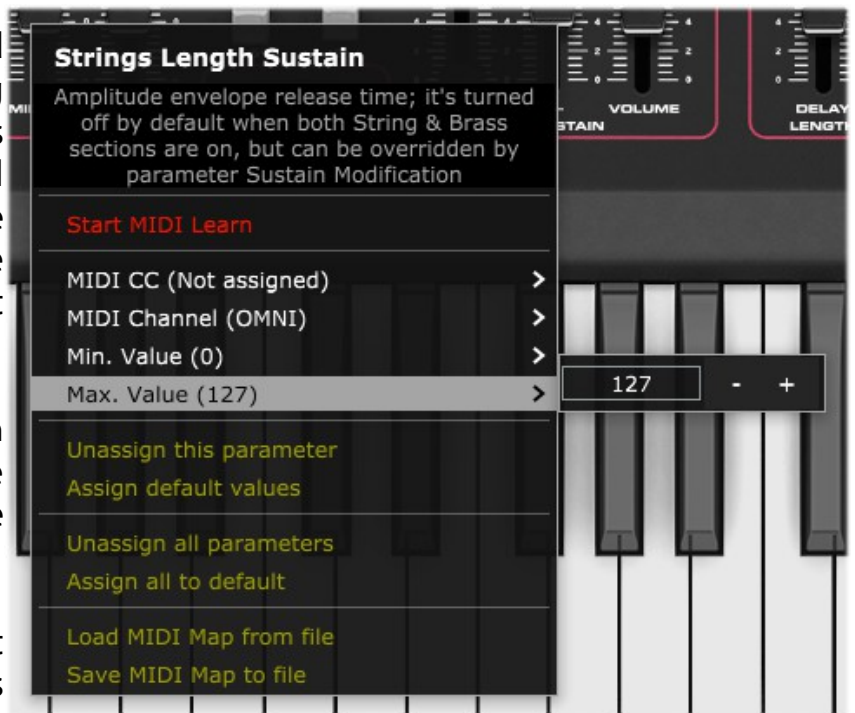

A dialog window appears which you should give confirmation to if your assignment is done as expected, or you can click on “Abort” and abandon the operation.

If you're creating your map but you don't need to catch the CC numbers from your controller, you can still use the other menu options to set the values manually. Set the CC number, the MIDI Channel (1 to 16 or OMNI), the min and max values. If min and max are swapped (i.e. min is major than max) the parameter will respond reversed.

You can “unassign” a parameter if you don't want it to be controlled by any MIDI message, or you can assign default values if you're unsure what assignment to give to it.

Last but absolutely not least important, you can save your entire MIDI map to a file or load it from a previously saved file, so you can have more mappings ready for different controllers that you might have.

END USER LICENSE AGREEMENT

This License Agreement is a legal agreement between the User, hereafter called "you", and CRUMAR regarding Performer software. Performer in the following of the contract includes the computer software named Performer and associated media, CD and product documentation. Performer also includes any updates and supplements to the original Performer provided to you by CRUMAR. By installing, accessing or otherwise using Performer, you agree to be bound by the terms of this License Agreement.

1 Performer License

Subject to the limitations described below, CRUMAR, as licensor, hereby grants you, the licensee, a non-exclusive, perpetual License to use Performer in accordance with the documentation provided by CRUMAR.

1.1 GRANT OF LICENSE

This License Agreement grants you the following rights:

(a) Software. You may install and use Performer for an unlimited period on at most three Computers provided that these Computers belong to you and that Performer is used only on one Computer at a time.

(b) Reservation of Rights. All rights not expressly granted are reserved by CRUMAR.

1.2 LIMITATIONS

(a) Strict personal use. Your use of Performer is limited to strict personal use. You may not rent, lease or share Performer with another user. Transfer of License to another user is allowed once for each licensed product. A License transfer fee must be paid by the current License holder before the transfer takes place. For this purpose, please contact info@crumar.it.

(b) Sound produced by Performer can only be distributed within a musical context, and not in forms that allow the sounds to be used as sample based instruments or sample libraries.

(c) Limitations on Reverse Engineering, Decompilation, Disassembly and Modification. You may not reverse engineer, decompile, disassemble or modify Performer.

(d) Limitations on usage. You may not merge Performer into another software nor create derivative works based on Performer.

(e) Separation of Components. Performer is licensed as a single product. Its component parts may not be separated.

(f) Termination. Without prejudice to any other rights, CRUMAR may terminate this Agreement if you fail to comply with the terms and conditions of this Agreement. In such event, you must destroy all copies of Performer and all of its component parts.

1.3 COPYRIGHT

Performer is protected by copyright laws and international copyright treaties, as well as other intellectual property laws and treaties. All title and intellectual property rights related to Performer are owned by its authors. Unauthorized copying of Performer, in whole or in part, is expressly forbidden. All title and intellectual property rights in and to the content which may be accessed through use of Performer is the property of the respective content owner. This Agreement grants you no rights to use such content. You may print one copy of the documentation provided in Performer.

1.4 BACKUP COPY

After installation of Performer you may keep one copy of the file provided by CRUMAR solely for backup or archival purposes, provided that its component parts are not separated. You may not distribute copies of Performer or accompanying documentation.

1.5 OWNERSHIP

Performer is licensed to you, not sold nor given. This License Agreement does not constitute a transfer or sale of ownership rights for Performer. Except for the License rights granted above, CRUMAR retains all right title and interest for Performer including all intellectual property rights therein.

2 WARRANTIES

Performer is licensed without any warranty. It is provided on an "as is" basis.

3 LIMITATION OF LIABILITY

You agree that in no event will CRUMAR be liable for any kind of damages, material, immaterial or corporal, that arise as a result of the malfunctioning or misuse of Performer. You assume full responsibility for all possible consequences of your use of Performer.

4 DISPUTE

This License Agreement is governed by the laws in force in Italy, and, in respect of any dispute which may arise hereunder, you consent to the jurisdiction of the courts sitting in Treviso, Italy.

All software by Guido Scognamiglio, Luigi Felici and Michele Picaro. Project manager: Andrea Agnoletto
Graphic design by Pierre Collard.

All trademarks used herein are the property of their respective owners.

VST technology by Steinberg. AU technology by Apple.

CRUMAR is a trademark. Performer software is distributed by: VMConnection - Treviso - ITALY

Last update: November 2020

www.crumar.it