

# VCS3

## The PUTNEY

COMPACT ELECTRONIC MUSIC STUDIO

# Users Manual

---

ELECTRONIC MUSIC STUDIOS (LONDON) LTD.

---



# Manual

for the operation and maintenance of Voltage Controlled Electronic Music Studio Type VCS3, a product of Electronic Music Studios (London) Ltd., 49 Deodar Road, London S.W.15, England.

## Contents

I SPECIFICATION ... ..	page 1
II GENERAL INTRODUCTION ... ..	page 4
III CONNECTING THE VCS3 AND USING THE MATRIX BOARD ... ..	page 6
IV DETAILED OPERATION OF DEVICES	page 8
V EXTERNAL EQUIPMENT AND SPECIAL PATCHES... ..	page 20
VI MAINTENANCE AND FAULTFINDING	page 23
VII SPECIMEN PATCHES ... ..	page 26
VIII GLOSSARY ... ..	page 42

This copy supplied with VCS3

Serial No.....

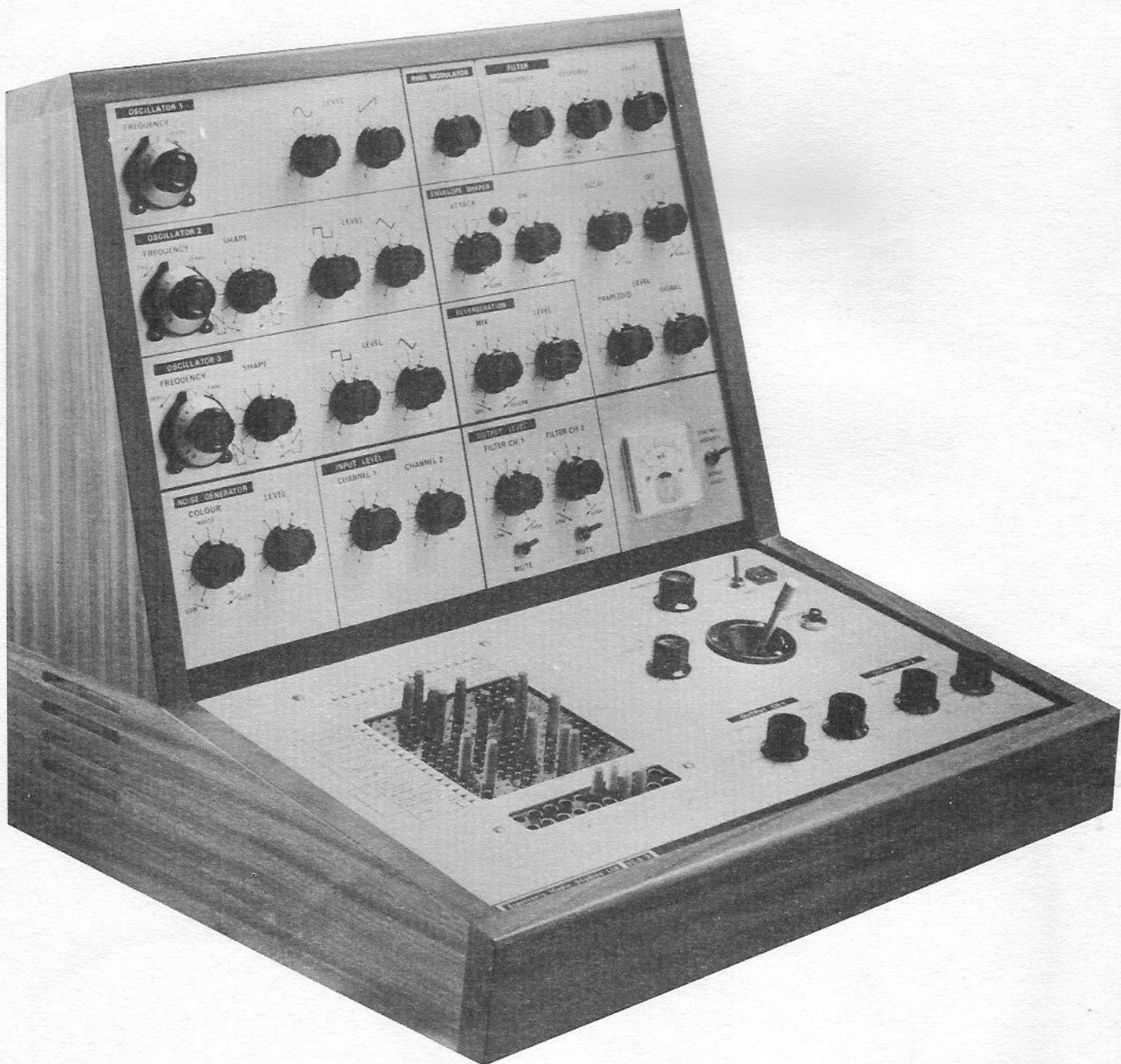

# How to use this Manual

If you have no experience of electronic sound generating devices, and little technical knowledge, start by reading Sections II and III, then progress slowly through Section IV, referring to the Specimen Patches (Section VII) where relevant. Section V contains advice on special uses for the Studio, and will only be needed by experienced operators. Section VI, on Maintenance and Faultfinding, should be read for its general advice, but internal adjustments should not be attempted unless suitable measuring equipment is available, and the user has experience of modern solid state electronics. Section I, the Specification, gives all the technical facts necessary to use the VCS3 with ancillary equipment, and for an engineer to check its performance.

ERRATA AND ADDENDA

# I – Specification

## GENERAL

The VCS3 (Voltage Controlled Studio Mk3) is a self-contained unit comprising *Sound Sources, Treatments* for these sources, *Amplifiers* for bringing signals and controls in from, and leading them out to, external equipment, *Loudspeakers* and a *Power Pack* capable of accepting any AC mains supply in the 230V or 110V ranges.

The VCS3 is intended to be useful in several distinct applications, amongst which are the following:

**As a complete unit in itself**, using its own internal loudspeakers, and needing no ancillary equipment.

**As the main unit of an electronic music studio**, combined with tape recorders and other equipment. This could include extra indicating devices such as oscilloscopes and frequency meters, and extra source or treatment devices.

**As a live performance instrument**, connected to power amplifiers and large speakers, and accepting inputs from microphones and other sources as well as generating its own sound.

**As a sound effects generator**, patched in to a studio recording system or a theatre reproduction system. The VCS3 can generate a large number of different kinds of effect.

**As a teaching aid**, the studio can demonstrate all the main acoustic phenomena simply and clearly. It can be operated by students, and used with any convenient indicating or recording device.

The main electronics are mounted on three printed circuit boards, and other devices in the cabinet include the manual control potentiometers, the 16X16 matrix board with patching pins, the mains transformer and rectifier, the reverberation springs, the loudspeakers and various lamps, sockets, switches etc.

The cabinet is of solid afrormosia wood, with sliding back and bottom covers. The panelwork is in heavy gauge aluminium with a satinised finish, screen printed legending and a Mylar coating which can be written on. A strong plastic dust cover is supplied, together with mains lead and a selection of jack plugs.

**Dimensions:** 17½" (438mm) high X 17½" (444mm) wide X 16½" (419) deep

**Weight:** (including mains lead and slip cover) 22½lbs (10.2 Kg)

## DETAILED SPECIFICATION

**Mains Input:** 220-245V, or 105-115V, AC 50 or 60Hz. Connection by miniature 3-pin plug. In countries using 2-pin wall outlets it is not necessary to make a ground connection, and since the input is floating the polarity is not important.

**Mains Fuse:** 1A, tubular type, access on back panel by mains input.

Studios destined for Europe will normally be set at 245V, and those for North America at 110V. To change the voltage range, remove the bottom panel (1 wood screw) and move the plug by the mains transformer (mounted near the joystick). Particularly if it is set to the low range, make sure that the input socket is marked to indicate this. To remove the bottom or back panels, first turn the studio on to its face.

Mains lead connections (back of plug):

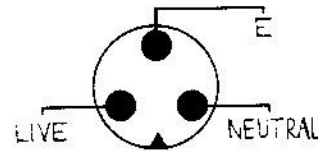

## Oscillator 1:

Max. Output Levels: sine – 3V p-p  
ramp – 4V p-p

Frequency Range: (dial only) – greater than 1Hz–10KHz

Dial relationship is 1.5 octaves  $\pm 2\%$  per major division, and the actual dial calibration, when properly set up, is as follows (the extreme positions may be outside the tolerance):

DIAL NO.	0	1	2	3	4	5
FREQ (Hz)	(0.6)	1.7	4.1	11.6	32.7	92.5

DIAL NO.	6	7	8	9	10
FREQ (Hz)	261.6	740	2,093	5,920	(16,750)

Voltage control sensitivity (include 2.7 Kohm patch pin resistor) = 0.32V/octave. External voltages through input channel give 0.16V/octave since input channels have a voltage gain of 2.

**General Note on Control Voltages:** Specifications give ranges for manual control of v.c. parameters. The ranges can be extended by additional control voltages.

## Oscillator 2:

Max. Output Levels: square/pulse output – 4V p-p  
triangle output – 3V p-p  
ramp positions of triangle – 6V p-p

All other details are the same as Oscillator 1.

**Oscillator 3:**

Max. Output Levels: square/pulse output — 4V p-p  
 triangle output — 3V p-p  
 ramp positions of triangle — 6V p-p

Frequency Range: (dial only) greater than 0.025Hz  
 (40 secs per cycle) to 500Hz

Calibration of dial as follows (extreme low frequency varies slightly from example to example):

DIAL NO.	0	1	2	3	4	5
FREQ (Hz)	(0.015)	0.043	0.122	0.344	0.975	2.76
PERIOD (Secs)	(65)	23.2	8.2	2.9	1.02	0.36

DIAL NO.	6	7	8	9	10
FREQ (Hz)	7.82	22.2	62.5	177	500
PERIOD (Secs)	0.128	0.045	0.016	0.0056	0.002

Voltage Control sensitivity: 0.26V/octave

**Noise Generator:**

Max. Output Level: 3V p-p

**Ring Modulator:**

Max. Input Levels for undistorted output: 1.5V p-p

Max. Output Level with 1.5V on both inputs: 6V p-p

1.5V indicates about 0.45 on the Meter for sine waves. Above this level there will be some breakthrough of spurious overtones. Breakthrough with 1.5V p-p to one input only is 5mV p-p (-60dB)

**Filter/Oscillator**

Frequency Range in all functions: (knob control only) greater than 5Hz to 10KHz

**As a Low Pass Filter** (Response knob to 0 — 'Low Pass Position') Cut off rate 12dB for first octave and 18dB per octave thereafter

**As a Resonator** (Response knob about halfway — 'Hi-Q Position') Max. stable Q factor: 20

**As a Sine Wave Oscillator** (Response knob to about 7 or more) Low distortion sine wave output over whole frequency range.

Voltage Control sensitivity: 0.2V/octave.

**Envelope Shaper and Trapezoid Output:**

Max. Repetition Rate: 60Hz

Attack Time: variable from 2mS to 1 second  
 On Time: variable from 0 to 2.5 seconds  
 Decay Time: variable from 3mS to 15 seconds  
 Off Time: variable from 10mS to 5 seconds

Decay Time can be voltage controlled, and the Control sensitivity is 0.4V/octave — i.e. an increase of 0.4V will double the Decay Time.

Trapezoid Output Voltage Range: from -3V (ON) to +3V (OFF)

**Reverberation Unit:**

The double spring delay line (mounted under the front left part of the lower panel), has delay times of 25mS and 30mS. Maximum reverberation time is greater than 2 secs.

The output of the Reverberation Unit can vary by 10:1, depending on the exact frequency. This means that very large peak outputs may occur even when the average level is quite low. When the unit is overloaded, or when it overloads subsequent devices, distortion will occur, particularly when a tone of slowly varying frequency is being used.

There can also exist conditions in which acoustic feedback occurs when using the internal speakers. In the small VCS3 cabinet this is unavoidable, but it will only occur under extreme conditions, and not at all when external speakers are being used. A slight reduction in reverberation mix, and in some cases levels, will check it.

Voltage Control of Reverberation Mix: -2V for no reverb  
 +2V for max. reverb

**Input Amplifiers:****Microphone Inputs** (MIC jack sockets)

Sensitivity: (2X) 5mVAC into 600 ohms

In fact the input characteristics are flexible enough to give satisfactory results with most devices, even if the impedance is considerably higher than 600 ohms (e.g. crystal microphones). Low impedance microphones and pick-ups, however, should be fitted with transformers and/or preamplifiers.

**High Level Inputs** (HI LEVEL INPUTS jack sockets)

Sensitivity: (2X) max. 1.8VAC (r.m.s.) or  $\pm 2.5$ VDC into 50 Kohms

These are the normal inputs from a tape recorder or radio, but since they are directly coupled they can also be used for a DC control input. There is no objection to one channel being used for a signal and the other for a control, since they are quite separate circuits.

**(Low Level Inputs**

Sensitivity: (2X) max.  $\pm 50\mu$ A into 500 ohms)

These inputs are not available at jack sockets, and are not normally used, since they are much too sensitive for most purposes. They are in fact a DC version of the microphone inputs, and are found at the Keyboard Jones Socket (q.v.). In general, however, these should be reserved for use with special extra equipment such as the EMS Keyboard.

The three (normally two) inputs to each channel must be used separately — e.g. if Channel 1 MIC input is busy the HI LEVEL input to Channel 1 cannot also be used. But different kinds of input can of course be applied to each channel:

**General Note on Arrangement of Jack Sockets:** The jack sockets are arranged so that Channel 1 (or in one case L for Left) is in its correct position viewed from the FRONT of the studio. For this reason they may a

first seem to be the wrong way round when viewed from the BACK. But we consider this the most logical arrangement.

### Output Amplifiers:

Two amplifiers with Manual and Voltage Control of gain, and manual top and bass roll-off controls. There are four pairs of outputs, three of these being available at jack sockets for external use.

#### Signal Outputs (SIGNAL OUTPUTS jack sockets)

Level: (2X) 2V p-p max. into 600 ohms

These outputs are marked L and R instead of 1 and 2, because they are under the control of the PAN knobs on the lower front panel. These are the normal outputs for tape recorders, amplifiers etc. They should go to a high level (e.g. radio) input, and never to an input with built-in compensation for a non-linear device (e.g. pick-up or tape head inputs).

#### High Level Signal Outputs (HEADPHONES (STEREO) jack socket)

Level: (2X) 10V p-p max. into 50 ohms

These outputs go to a *stereo jack socket*. *Do not use a 2-way jack in this socket or one side of the high level output will be short-circuited.* A three-way jack is supplied with the studio, and is normally supplied connected to a pair of stereo headphones when these are purchased. The *tip* of the jack is connected to the left channel, the *ring* to the right channel, and the main body to ground.

This is a non-panning output, and although intended principally for headphones it can be used wherever an especially high level output is required. The outputs to the internal speakers are also non-panning, and for this reason the PAN controls are marked (EXT.).

#### DC Outputs (CONTROL OUTPUTS jack sockets)

Level: Depends on the setting of the device from which a control is being taken. It is approximately the same as the figures given for each device. The optimum load for this output is 10 Kohms, and it should not be less than 2 Kohms.

These sockets are connected to Rows B and C on the Matrix Board, which is why those letters are printed by the sockets. They are, in fact, taken at the inputs to the output amplifiers, up to which point the chain is directly coupled.

### Meter:

A 1mA moving coil meter movement is switched to read two ranges as follows:

As a **centre-zero DC meter** (switch to Control Voltages): range is  $\pm 1$  VDC, 0 volts being in the centre of the scale.

As a **lefthand-zero AC meter** (switch to Signal Levels): range is 4V p-p for full scale deflection.

### Joystick:

Two potentiometers mounted at right angles are simultaneously controlled by a joystick whose limits of movement describe a square area.

Whatever the setting of the range controls, the joystick should give OVDC from both its outputs if the stick is precisely central. Moved down and/or to the left the controls are more negative, and vice versa, the amount depending on the range control settings, which are independent and may be quite different. The most positive position for both is the top right hand corner.

Joystick Range (Range Controls at max.): (2X)  $\pm 2$  VDC

### Matrix Board:

16X16 way pinboard (256 locations), inputs on vertical rows, outputs on horizontal rows. The tips of the pins go to outputs, and the shafts to inputs. *Do not use patch pins other than those supplied;* there are various types of matrix board, and the wrong pins can easily damage this expensive item. In addition, VCS3 pins are neither shorted nor fitted with diodes (as other pins commonly are), but with resistors.

All devices at patchboard:

Input Impedance: 10 Kohms constant  
 Input Sensitivity: Average 1.5 p-p for full range.  
 Output Impedance: 300 ohms to 3 Kohms depending on output level control of device.  
 Output Level: Generally about 2V p-p, but all devices can deliver considerably more than this.

Patch Pin Resistor — 2.7 Kohms

The problem of designing an all-purpose patch is to combine ease of use with acceptable levels of cross-talk, and we consider that the best compromise has been achieved. Inter-row capacitance is approximately 50pF. There can be a small amount of high frequency cross-talk to open circuit inputs, but this is reduced by about 12dB when an input is busy.

### KEYBOARD Jones Socket

This is intended for use with EMS devices, and these are supplied with a plug to fit this socket. *Do not attempt to use this facility unless the suitability of the proposed equipment has been thoroughly checked.*

Socket Connections:

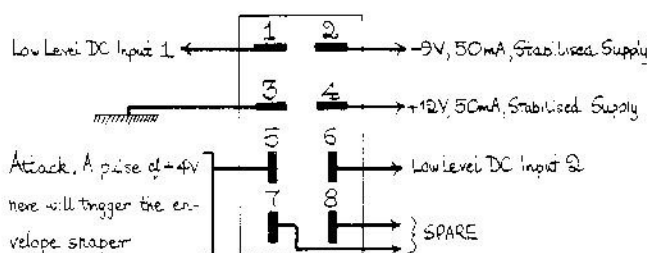

**WARNING:** Great care must be taken not to short circuit supply rails to themselves or to Ground (Pins 2, 3 and 4). Damage to the VCS3 will almost certainly result unless the fault is only momentary.

### SCOPE Jack Socket

This socket is connected to Row A, and therefore sees any output connected to the Meter. In conjunction with the Control Output sockets, there are three possible ways of gaining access to the Matrix Board.

Although this socket is marked SCOPE (for Oscilloscope), it can be used for a variety of purposes, including feeding back a signal into the studio via one of the Input Amplifiers (see Section V).

### General Notes on Connecting External Equipment

- 1) Always make sure that the specification of the device agrees with the figures given in the foregoing pages *before* connecting it.
- 2) Watch out for "earth loops" – see Section VI

- 3) Don't forget that all jacks are 2-way (body and tip) except the Headphones jack, which is 3-way (body, ring and tip).
- 4) Make sure that any extra jack plugs you buy are a proper fit – tight but not too tight – and that the live connection (tip) is firmly gripped by the socket spring. Forcing in the wrong jack plug may damage the socket.
- 5) Always use screened leads, and pre-tin both the jack plug lugs and the lead and screen, so that the final joint can be made in the minimum time. Too much heat will cause the insulation to melt back and possibly short circuit the lead.
- 6) Use whatever form of cable grip is provided on the jack plug, so that mechanical strain does not fall on the inner lead or soldered joints.

---

## II – General Introduction

The VCS3 is not 'played' like a conventional musical instrument, but it is all the same capable of a far greater range of sounds than any one musical instrument, and since its controls are all continuously variable the varieties of sound obtainable are literally endless. We think you will find the following pages helpful in getting the best from the instrument, but our suggestions are not meant to be exhaustive, and are designed principally to enable you to realise sounds you have devised yourself.

The important initial step is to understand the way in which the many circuits of the VCS3 are arranged for convenience in use, and to be able to follow the logical path of your desired sound from source to loudspeaker.

Devices in the machine are of two basic kinds. The first is a *Generator* or *Source* device, which we can represent as a box with an arrow coming out but none going in.

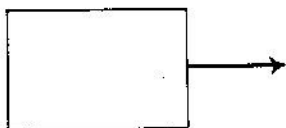

Devices in this category are the three Oscillators, the Noise Generator, the Filter when oscillating, and the Trapezoid Output. In later pages each of these is described in detail.

The other basic sort of device is a *Treatment*, and this is like a box with one or more arrows going in and one coming out.



Treatments in the VCS3 are the Filter, the Envelope Shaper, the Rigg Modulator, the Reverberation Unit, and the Input and Output Amplifiers. The amplifiers, if used simply as such, are only Treatments in the sense of making the signal larger, but the Output Amplifiers can be used in a way (as we shall see) which makes them genuine treatment devices.

The output amplifiers lead to loudspeakers in the VCS3 or out to other amplifiers, tape recorders etc. Sometimes the output goes to a meter which monitors the behaviour of the sound. A *Terminal* device can be shown as a box with an arrow going into it.

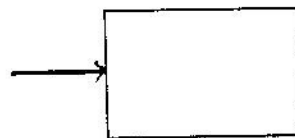

We can represent any complex of circuits as an arrangement of boxes if we wish, and you may find it helpful sometimes to draw boxes to show what you are aiming at, before setting up the VCS3 to produce the sound.



Before going further, it is essential to introduce one further idea, because it is vital to the operation of the studio. This is the principle of Voltage Control. Traditionally designed source or treatment devices have only manual means of varying their principal parameters, whatever they may be (and this depends on the function of the device of course). The circuits in the VCS3, on the other hand, have as well as manual control the possibility of voltage control. By this we mean that by applying a voltage to a special input on the device its main parameter can be automatically varied. In our box drawings we can add another arrow going in and mark it C for Control.

To distinguish the two types of input, we talk of a Signal Input and a Control Input, and this Control may be a steady voltage, giving a steady output, or a varying voltage,

A very simple sound, in this case a single tone from an oscillator, would need a block diagram like this:

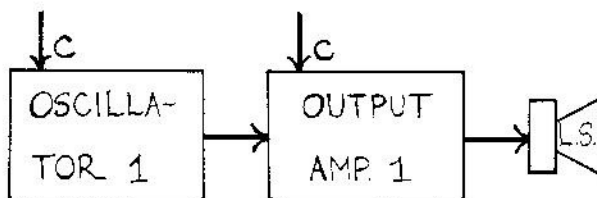

The Control Inputs have not been connected, and we are using only the Manual control knobs for each device. In Section IV the precise use of all knobs is explained.

A more complex arrangement, but still relatively simple for a studio as versatile as VCS3, would be:

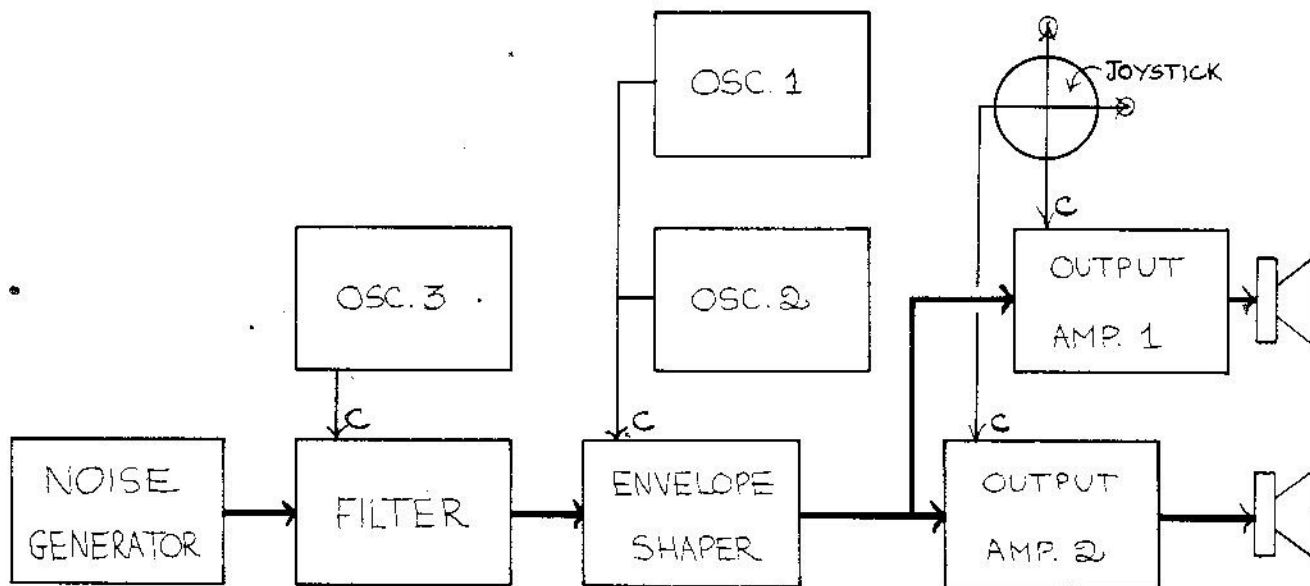

in which case the output will vary with it. The parameter under control is clearly marked, but is usually self-evident — for example the control input of an oscillator will vary the frequency, that of an amplifier the gain, etc. What gives the VCS3 its great versatility is that one device can be made to act on the control input of another, and whole chains of interdependent events can be built up in this way.

It is very important to make up your mind for what purpose you are using an available voltage — whether as a Signal (to be heard) or a Control (to modify another device). Sometimes the same signal is used for both purposes, but in the main we will find that Controls tend to be of much lower frequency than Signals, and this is why several of the Sources can produce very low frequencies indeed, well into the subsonic spectrum and useless as audible sounds. Oscillator 3 can produce a frequency approaching one cycle per minute, and the Envelope Shaper can also make very slow changes.

If the Control Input is marked with a C, there is no need to mark the Signal Input, and the two main types of box now look like this:

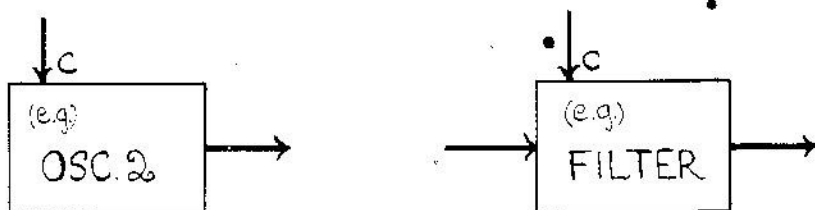

This would produce a varying swishing or roaring sound, with the level and with movement between the speakers controllable by the joystick (a manual double voltage control device). In the next Section we will see how the above block diagrams are interpreted on the studio.

Although the VCS3 can generate a very large number of types of sound by itself, you will almost certainly wish to connect it to external amplifiers and/or tape recorders, and feed into it from microphones and other sources. There are ample connections to do these things, and details of the various jack sockets are given in the Specification (Section I). The studio is delivered with a supply of jack plugs, but these are in any case standard items and spare ones can be obtained from any good radio shop. Advice on soldering leads to jack plugs is given at the end of Section I, and notes on external equipment both in Section I and Section V. Note that the Headphone jack socket uses a different type of jack plug (3-way) from the others (2-way).

## III Connecting the VCS3 and Using the Matrix Board

Unless otherwise stated by a label, the mains transformer is set to 245 volts, and after the lead has been fitted with a suitable plug the studio can be plugged in and switched on (MAINS ON), when the red lamp by the switch should glow. *The studio must on no account be connected to a DC supply.* The small red light on the upper panel may also glow or flicker, and this is quite normal. If your mains supply is lower than 240V a tapping can be selected by removing the bottom panel (place the studio on its face — like an inverted “V”). But it is better to set to the tapping next highest to your supply than risk too high a running voltage. For use in the USA or other areas having 110V supplies, a suitable tapping is also provided, and it is advisable to mark the mains input point clearly if it is set for the low range. For mains lead connections, see Section I (Specification).

The studio is now running, but no sound will be heard until one or more pins are inserted into the matrix board. Since no results can be obtained until the operation of the matrix board is understood, we are devoting the remainder of this section to this important component. In the next section the devices themselves are explained in detail.

In order to arrange our Sources and Treatments into patterns of blocks, such as we outlined in Section II, we must have some means of connecting one block to another. In theory this could be done by switches, but a moment's thought will show that in order to achieve the very large number of possible combinations we wish to have available, the switches would have to be very numerous and complicated, and would defeat their purpose by being almost impossibly cumbersome to use. All studios of any complexity, therefore, while they may fit switches for very common operations, also have a flexible plugging system which we call 'patching'. Most patches are achieved by loose wires and plugs known as patch cords, and rows of holes somewhat like a telephone exchange. Not only can patch cords be broken very easily, but the system takes up a lot of room and when any complex patch is made the

result is a mass of tangled wires. The miniaturised patch board fitted to the VCS3 allows any one or more of 256 different connections to be made by the simple insertion of a small pin. The insertion of one pin connects one input to one output, each identified by the intersection of two rows of holes at right angles. The outputs are ranged in horizontal rows, labelled both with function and with numbers, and the inputs are arranged in vertical rows, also identified, but in this case by functions and letters. To make things even easier, the Signal Inputs are shown by letters in round boxes, and Control Inputs by letters in square boxes. Furthermore the appropriate numbers and letters are also repeated near the device they refer to — e.g. the Envelope Shaper has  $\textcircled{C}$  by it, which means that its Signal Input is row  $\textcircled{C}$ . It has the letter  $\square{D}$  by DECAY, which means that the Decay Time voltage control is on row  $\square{D}$ . The two outputs (Trapezoid and Signal) are marked 11 and 12, and these are the rows on the matrix board where these outputs can be found.

Let us consider the first simple block diagram we drew in Section II, and lay it out in terms of the matrix board. Oscillator 1 output is either row 1 or 2, depending on the waveform you require (or both if you like). The input to Output Amplifier 1 is on row B. One pin inserted at B1 or B2 will therefore produce the single tone we were looking for.

If you try this and achieve no sound, it may be because (a) Osc.1 is set to a sub- or super-sonic frequency, (b) the appropriate Osc.1 level control is at zero, (c) the Output Amp.1 level control (on lower panel) is at zero or (d) the speaker muting switch for Channel 1 is down.

It is worth mentioning here that there are many settings of the VCS3 which produce no sound, but once you understand the logic of its devices you will yourself go about the operation of the controls in a logical manner. The basic lesson from this simple patch is that *you will hear nothing unless there is a pin in row B or C or both.* — i.e. you must finish any patch by connecting to an output amplifier.



Now although this patch gives us a swept coloured noise controllable in various ways, this will not happen unless you have also set up the knob controls correctly, and apart from reading the advice given in the next section, you should now try the effect of moving the knobs from their suggested positions. It is a firm rule, however, that unless you have a patch which can produce the kind of sound you are looking for, no amount of manual alteration will achieve it for you, so give a great deal of thought to the correct placing of the pins. Practice with different combinations of devices will teach you how to analyse the sound in your mind's ear into the complex of devices which will produce it.

General procedure for patching:

- 1) Think of the kind of sound(s) you want.
- 2) Think of a sequence of devices which will produce this, and set the relevant knob controls more or less in the positions you think will be correct.
- 3) Make a trial patch.
- 4) If disappointed the first time, check the knob controls to make sure they are not set so that no sound can be heard anyway, or set wrongly for the sound you had in mind.
- 5) If even then the patch seems unsuccessful, simplify it and build it up stage by stage. There are often several ways of achieving a given sound.

- 6) A device can sometimes be used in two ways at once, but cannot separate two mixed input signals. For example if reverberation is being used on Channel 1, you cannot also connect a Channel 2 signal to it without intermingling the whole result. But one control can affect signals in both channels, or more than one device — simply place several pins in the same row, as we did with Rows L and 12 in the above example.
- 7) Watch out for gross overloading. All of the devices will give some overall amplification if set at or near maximum level, but on the whole a Treatment should be set to give unity gain, and it is possible to produce very distorted sounds if everything is driven at maximum, and defeat the purpose of your patch. It is best to keep the main level controls (large knobs on Lower Panel) at about two-thirds to begin with, and build up levels from the start of the chain so that each stage is comfortably driven. Sometimes you will find it better to change the order of the Treatments — for example in the case we have just illustrated the sound would be different if the Envelope Shaper preceded the Filter, because the Control waveforms would be acting on the Signal in a different state.

In the next Section we describe the function of each device in turn, and your skill at patching will increase as you try the effect of each device and that of various combinations of them.

---

## IV — Detailed Operation of Devices

On the following pages each device in the VCS3 is considered separately. So far as possible, Sources are arranged on the left of the studio, and Treatments on the right, at least on the upper panel. The Input Amplifiers, although not Sources in themselves, become so when an Input is applied to them, and the use of these amplifiers is explained not only in this Section but in Section V.

These descriptions are intended to explain the practical use of each device, further technical information being available in Section I (Specification). As we have said before, the aim of this Manual is to stimulate your ideas rather than to impose ours, and the few examples given are meant as foundations to build upon, not complete guides to the use of the device in question. Do not hesitate to experiment with all kinds of patches not given in this book. The studio is designed so that it is virtually impossible to damage it electrically by wrongly connecting its internal resources, and our whole intention is that you should be adventurous rather than cautious.

The devices will be discussed in the following order (beginning at top left of the Upper Panel):

### Upper Panel

OSCILLATOR 1	}	Lefthand side
OSCILLATOR 2		
OSCILLATOR 3		
NOISE GENERATOR		
INPUT AMPLIFIERS		

RING MODULATOR	}	Righthand side
FILTER/OSCILLATOR		
ENVELOPE SHAPER		
REVERBERATION UNIT		
OUTPUT AMPLIFIERS		
METER		

### Lower Panel

MATRIX BOARD  
 MAINS ON/OFF  
 JOYSTICK  
 ATTACK BUTTON  
 OUTPUT LEVEL AND PAN CONTROLS

## OSCILLATOR 1

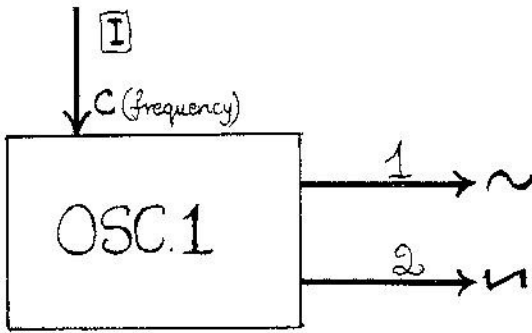

This Oscillator is intended principally for generating audible tone, but since its range extends downwards to 1 Hz it can be used in a variety of Control applications as well.

In building a tone, we must consider several elements, but such questions as the length or shape of the final note are usually decided after we have chosen a basic sound (though we may alter the basic sound later if we wish).

This Oscillator and Oscillator 2 have the same frequency range (more than the complete audible spectrum) but different choices of waveform. The nearer a waveform approaches to sine tone, the 'purer' it sounds, although sine tone itself is dull and characterless. One output from Oscillator 1 produces sine tone at a point near the centre of its Shape Control, and you can easily test this. Put a pin at B1, turn up Channel 1 output level (lower panel) to about 6, and set the frequency control to a middle position. Now turn up the Sine Level to about 4 or 5, and move the Shape Control through its whole travel. You will find one point near the middle which is suddenly very smooth. This is the sine point. To each side of this point the waveform gradually changes to the shapes shown below. In general, the rougher and sharper a waveform, the 'buzzier' it sounds, which means that it is rich in upper harmonics. Symmetrical waveforms either contain no harmonics (sine) or odd harmonics only. Unsymmetrical waveforms contain both odd and even harmonics. For a fuller explanation of this refer to any acoustics textbook.

The other waveform available from Osc.1 is a ramp or sawtooth, which is rich in both odd and even harmonics. We will see later that by using the Filter we can *subtract* harmonics from an otherwise rich waveform.

### Controls (L to R):

**Frequency** (slow motion dial). 1Hz-10KHz, extendible by Voltage Controls. The numbers on the dial do not refer to frequencies, but can be used as a method of logging dial setting. The relationship is in fact 1.5 octaves per major division on the dial, and a table of nominal dial calibrations is given in the Specification (Sect.1). In all cases of voltage controlled parameters, a given dial setting will only refer to a definite frequency (level etc.) if the setting has not been modified by a control input. The manual and electrical controls must be taken together.

**Shape Control.** This applies only to the Sine Output (next to the right). The shape changes on each side of the sine point in the following manner:



**Sine Output Level.** Decides the amount of output available at Row 1.

**Ramp Output Level.** Decides the amount of output available at Row 2. Since the two outputs are derived from the same Oscillator they are perfectly in phase and may be mixed (2 pins) to give a large variety of tone colours.

## OSCILLATOR 2

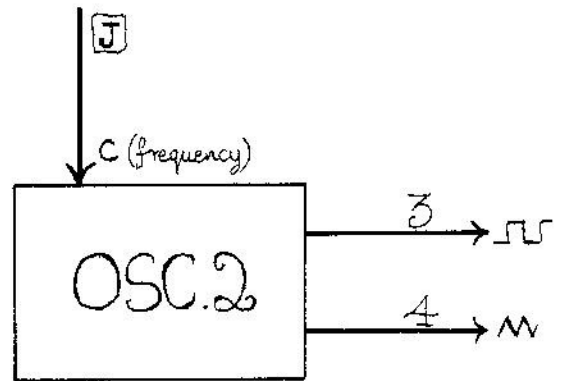

The range of this Oscillator is the same as that of Osc. 1. The difference is in the shape control arrangements and the outputs available. In this case they are square and triangle, not sine and ramp as from Osc.1, although since the shape control applies to both waveforms we can derive a ramp output from the triangle.

As with Osc.1 the symmetrical position is easily heard, because the even harmonics disappear – the point is quite critical. The square is a 'rough' sound, because the odd harmonic series is long and of relatively high amplitude. The triangle is also an odd harmonic series, but decreasing in amplitude much more rapidly. For further methods of tuning for symmetry, see the description of the METER.

### Controls (L to R):

**Frequency** (slow motion dial) As for Osc.1 (1Hz-10KHz)

**Shape Control.** This applies to both outputs, and it is important to remember this if you are using the outputs for different purposes – i.e. changing the triangle to a ramp also changes the square to a pulse. The shapes change as follows:

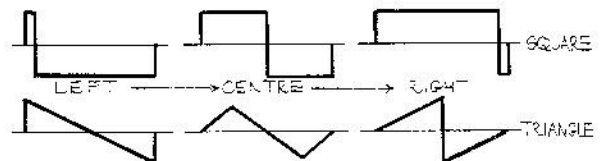

**NOTE:** When using the square/pulse shape, the extreme positions of the Shape Control give no output because the pulse becomes too short to be perceptible. The output then becomes in effect a steady DC.

**Square Output Level.** Available at Row 3.

**Triangle Output Level.** Available at Row 4. As with Osc.1, the two outputs can be mixed by inserting pins in Rows 3 and 4 together.

OSCILLATOR 3

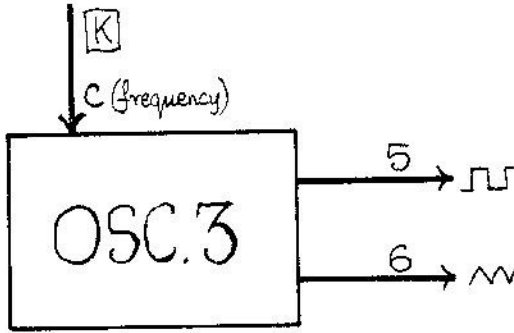

This Oscillator has the same shaping arrangements as Osc.2, but is very much slower, going down to a lower limit which varies slightly with each example, but is certainly greater than 40 seconds per cycle (0.025 Hz). Frequencies of this order should be regarded as changes of voltage over a period, since the only audible output is a click when the waveform reaches a sudden change of direction. It will, however, produce audible tone at the upper end of its range, reaching 500 Hz, or just short of an octave above Middle C.

Oscillator 3 is intended primarily for Control functions, although the sonic part of its range can of course be used when chords are required. To monitor the very slow changes, connect the Meter by inserting a pin at A5 or A6, and switching the Meter to Control Voltages.

Controls (L to R)

**Frequency** (slow motion dial). 0.025 Hz to 500 Hz. A table of nominal dial calibrations is given in the Specification (Sect. I).

**Shape Control**

**Square Output Level**

**Triangle Output Level**

As for Oscillator 2, but about 20 times slower for a given dial setting

At this stage, experiment with the three oscillators, singly and in chords as audio generators, and in various configurations of control. Three part chords can be made by inserting pins into one or both outputs of each oscillator on Rows B and/or C – or you can make the lefthand tone colour different from the right, by using, say, B1, C2, C3, B4, C5, B6. Oscillator 3 will only produce a sonic output at the upper end of its range (between about 7 and 10), and should usually be used as the bottom note of the three.

Or tone from (say) Oscillator 1 can be modified by putting an output from Osc.2 or 3 into its control input (I1). If Osc.2 frequency is set at or near its lower end, and pins placed in B1 (for Osc.1 output) and I3 (for control) a trill or tremolando will result. You can control the speed of this effect with the frequency control of Osc.2, its evenness with the shape control and its pitch range with the level control. If now a slow ramp from Osc.3 is applied to the same control (I6), a rising and falling series of notes can be produced. Again the various controls of Osc.3 will affect the nature of the pattern produced.

By using the ramp output of Osc.2 as well as that of Osc.3, a staircase waveform can be generated. The two level controls must be carefully adjusted if you want a steady pitch on each 'step', since as you can see from the diagram a change in either slope will affect the flatness of the level parts. Note that the ramps are in opposite directions: for the upward staircase below, Osc.2 Shape Control should be fully counterclockwise, and that of Osc.3 fully clockwise. (see below)

Applied as a control to Osc.1 this waveform will cause it to perform upwards or downwards scales and arpeggios. These must, however, be of the symmetrical variety (chromatic, whole tone, diminished sevenths, etc.) or of course intervals in between which have no staff notation equivalent. Musicians with an interest in intervals may care to tune Osc.1 so that Osc.1 is swept through an octave, and then tune Osc.2 to give unusual equal divisions of the octave, such as 10 or 13.

There are many such simple patterns to try, using only the three oscillators. One can control the other two, which will result in changing two part chords, or there are various circular control configurations, some of which interact in such a way as to give an illusion of randomness – i.e. they take so long to repeat themselves that there appear

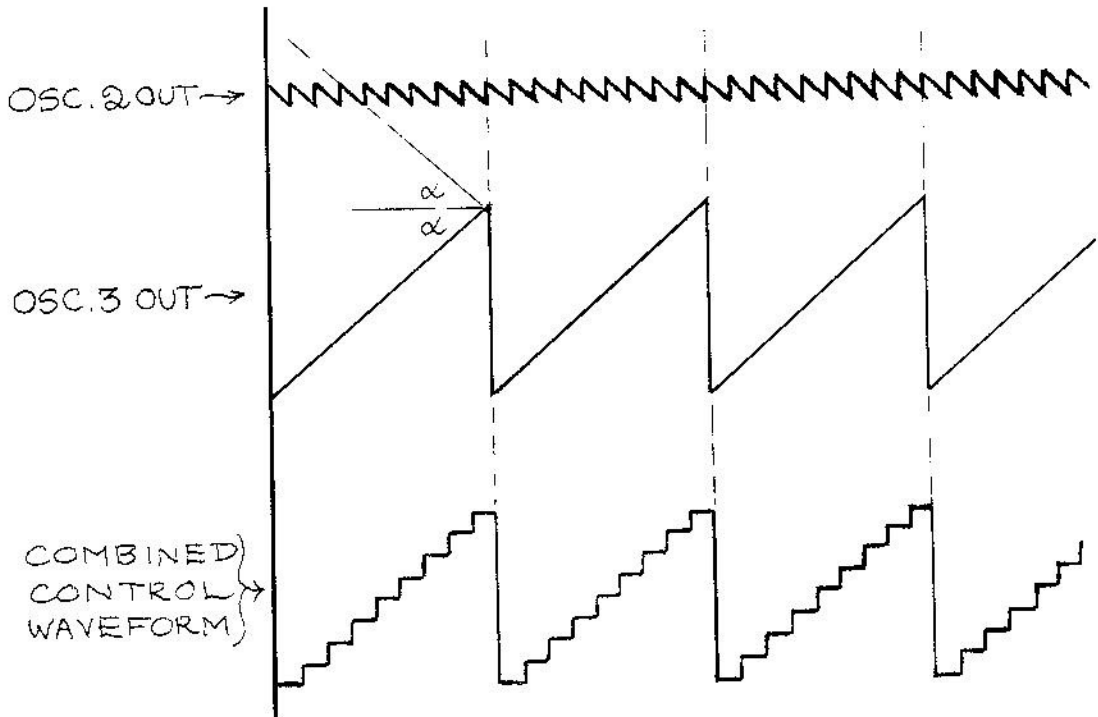

to be no regular pattern. An example of this is given in Specimen Patch No.2 (Section VII), which produces clicks in an apparently random manner. Study the arrangement of the pins and see how the Oscillators are acting on each other.

## NOISE GENERATOR

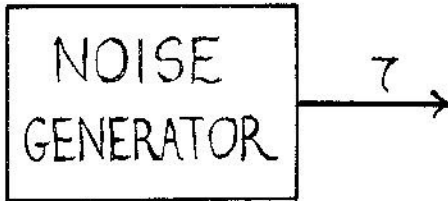

This device is not voltage controlled, and produces either 'white' noise or noise with some colouration. White noise can be compared with white colour, in the sense that the whole audible spectrum is represented in the same way that white light contains all colours (light frequencies). If you imagine an audible spectrum drawn out in the way that a light spectrum is often shown, a sine tone is represented by a single line on that scale (like the thin yellow line of sodium light). White noise, the opposite phenomenon, would be a picture of the whole spectrum at once.

When we are devising the best method of arriving at a sound we may work in two ways; either we start from a simple tone and make it more complex by adding to it, or we begin with a sound which contains all frequencies (white noise) and subtract from it to arrive at what we need. Or of course we may combine tone with noise in various ways.

As a guide to basic applications, coloured noise occurs in nature as such sounds as the wind and the sea. In music the unpitched percussion instruments (cymbals, snare drum, block etc.) all have a high noise content.

We will often find that we use Noise in conjunction with the Filter (q.v.), and when the noise is restricted to a narrow part of the spectrum we refer to the width of this part as the "Bandwidth" of the noise. But a degree of colouration (i.e. bandwidth restriction) is obtainable with the Colouration control on the Noise Generator.

### Controls (L to R):

**Colour.** Dark to the left (low pass filter), white in the middle (unfiltered), and high and light to the right (high pass filter).

**Level.** The amount of Noise available at Row 7.

You can listen to noise at B7, or without using any other devices you can frequency modulate one or more of the Oscillators with noise. At low frequencies you will hear noise chopped at the frequency of the Oscillator. At higher frequencies the result is a kind of pitched frying sound. Further experiments with noise will be possible when we have described some of the Treatment devices.

**IMPORTANT:** Because its design includes a circuit with a very large time constant, the Noise Generator will not operate for 20" to 30" after switching on the studio. This is quite normal, but should be remembered when you are trying to set things up very quickly.

## INPUT AMPLIFIERS

(see block diagram below)

These are not necessary for the internal operation of the studio, but are called into use for two main purposes — (1) to process an audio Signal brought in from an external source; (2) to influence devices in the VCS3 from an external Control source. High level AC/DC inputs are provided, as well as separate microphone jack sockets, but a given channel can only be used for one purpose at a time — e.g. if a microphone is being used on Channel 1 Input Amplifier, we cannot also use it for a DC control input. But the other Channel is completely independent, of course, and each can be used for a different purpose.

Do not feel that Input Amp.1 somehow belongs to Output Amp.1. There is no reason why you should not use both Input Amps. for a signal destined for either or both outputs — they are interchangeable.

A few typical inputs would be:

- (1) An air or contact microphone
- (2) A disc player or tape recorder playing in material which we wish to process (or even a radio).
- (3) Another VCS3 from which it is intended to derive a control voltage.
- (4) A remote control, such as a remote fader, which could be very simple and provide noiseless control from as far away as you like.

In general, tape recorder or radio outputs feed into the HI-LEVEL INPUT jack sockets. The MIC jack sockets are intended for 600 ohm microphones, but will accept inputs of higher impedance. Low impedance microphones should, however, be fitted with step-up transformers. Further information on using the VCS3 with external equipment will be found in Sections I and V.

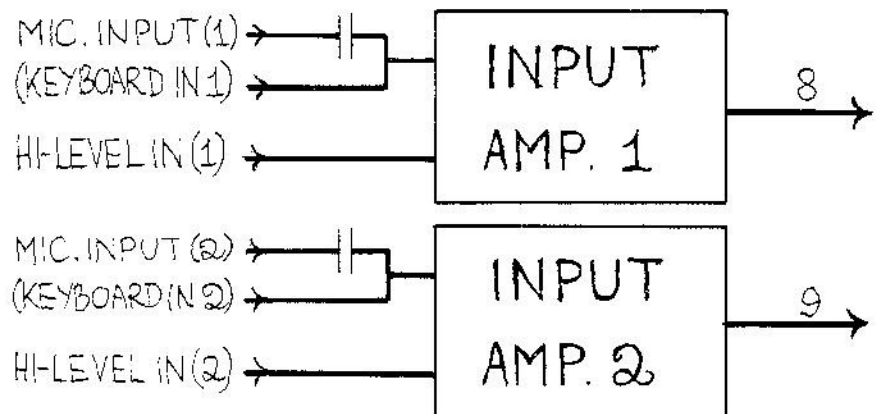

**Controls (L to R):****Channel 1 Level** Available at Row 8.**Channel 2 Level** Available at Row 9.

When you are not certain how large the input is, put the Level controls to zero *before* connecting. Connect the meter to the appropriate input channel (A8 or A9) and switch it to read the appropriate type of input (Control Voltages or Signal Levels). Turn the input up cautiously until the input signal level reads about half scale, and then connect it to its intended destination and adjust again until correct. If the needle goes right over as soon as you begin turning it up, make arrangements to attenuate the signal externally before bringing it in.

A very simple but useful function of these amplifiers is as straight through line or monitor amplifiers, in conjunction with the output amplifiers (pins in B8 and C9). For general studio work, you may need to filter a signal (for example), and the two sets of amplifiers plus the filter can be used for this purpose alone without using any of the other devices at all.

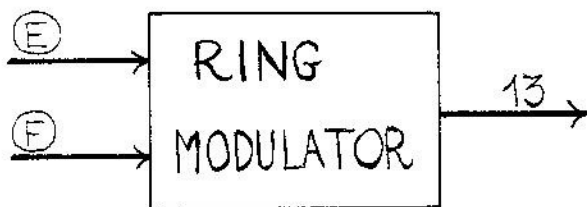
**RING MODULATOR**

This is the first Treatment we are considering, and its nature makes it unsuitable for Voltage Control, since it either functions correctly or not — there are no gradations of control possible. It has one control, the Output Level, inputs being controlled at the devices feeding the modulator.

**Control****Output Level** Modulated Output available at Row 13.

Elsewhere in the VCS3 we can obtain amplitude and frequency modulation (some of the experiments we did with the three oscillators were frequency modulation), but ring modulation, though a special case of amplitude modulation, has in practice a different function and effect. There is some analogy with the logical AND, in the sense that no signal is present at the output unless there is a signal at *both* inputs. This means that apart from normal modulation applications, we can use it as a switch by removing one input.

For a full understanding of modulation it is necessary to read more widely than this manual, but the essential facts are these: Modulation, though apparently similar to the operation of mixing (two inputs and one output) does not merely mix sounds and present the mixture. It actually *transforms* the inputs, and the output consists of new sounds not heard at all at the inputs. These new sounds (*modulation products*) are the result of both adding and subtracting all the input frequencies, giving sum and difference frequencies which only in special cases relate to the original frequencies harmonically (typical special cases are when the arithmetical relationship is a very simple one — e.g. octave). Modulation occurs in natural circumstances. For example if you speak or sing down a length of wide pipe your voice is modified by the pipe and emerges at the other end modulated at the resonant frequency of the pipe.

In this case, of course, the modulation is only partial and a great deal of the original inputs (voice and pipe note) can be heard. Ring modulation is a special case in which (provided the modulator is a good one) the inputs disappear altogether.

Take two sine waves — one by connecting to B1, turning Osc.1 frequency to about 6 on the dial, and tuning Shape Control for symmetry. Put another pin at C10, turn Filter Frequency (large knob) to about 5, Level control to maximum, and advance Response until the Filter oscillates. Tune the two notes to an exact unison (tune out the beats). At this point you should check the signal level because the Ring Modulator inputs should not be higher than 1.5V peak to peak for undistorted output. This level will read 0.45 on the Meter (slightly left of centre). Check by switching Meter to Signal Levels and plugging it first at A1 and then at A10. Adjust the level controls so that outputs are equal and below the above level (say 0.4).

Change the pins to E 1, F 10 and B 13. You should hear an octave of the original note. Now slowly turn Osc.1 tuning to about 5.3 (one octave down — you can if you like prepare this position while tuning the unison). During the retuning two notes will have been heard at the output, one rising and the other falling, and neither of them the original notes. This is because the sums and differences have been moving towards each other, as follows:—

	F A L L I N G →									
SUMS	600	580	560	540	520	500	480	460	450	} SUPPRESSED
OSC.1	300	280	260	240	220	200	180	160	150	
FIL./OSC.	300	300	300	300	300	300	300	300	300	
DIFFS:	0	20	40	60	80	100	120	140	150	
	← R I S I N G									

At the end of the run you should hear a note one octave below the original, plus its twelfth above. A comparison of ring modulated tone with the same tones unmodulated can be found at Patch 3, Section VII.

Most ring modulators have some 'breakthrough' and distortion, so that the output waveforms are not only degraded, but contain some of the original inputs. The VCS3 transformerless integrated circuit ring modulator is extremely efficient, and this depends on its maintaining perfect balance. After a great deal of use this balance may have to be adjusted, and instructions for doing this are given in Section VI.

Although we have mentioned that the levels should be kept below 0.45 on the Meter, do not be inhibited by this. The amounts of distortion and breakthrough will still be acceptable at much higher levels, and no harm except unwanted results will come from overloading this robust device. Do not feel it is necessary to make Meter checks all the time.

The Ring Modulator is a very useful and versatile device, and we now give a few typical examples of its application:

- 1) Transforming Instrumental Sounds** Plug a microphone to MIC 1 input socket (perhaps another to MIC 2 — one could be an air microphone, the other a contact type). These go to one input of the Modulator (E8, E9), and the two input amplifier level controls will be varied to give the desired result. The other input will normally be fed by a sine tone, which gives the purest result, since a rich tone or a chord will give rise to outputs of great complexity, sometimes even confusion — however you are advised to experiment with all types of input. The purest sine available is from the Filter/Oscillator (see p. 13) for detailed



description). Put a pin at F10 and the Response control to 7 or more. Finally a pin at B13 or C13 or both will connect the output (or of course other Treatments can be added as well). This arrangement will completely transform the sound of a voice or instrument, and you should try the effect with different settings of the Filter/Oscillator frequency.

2) **Frequency Doubling** Perfect octaves will be obtained if the Filter/Oscillator output (set as above) is applied to *both* inputs (E10, F10). This special case gives difference frequency = 0 and summation frequency = 2 X original = octave. Connect both original (B10 or C10) and modulated output (B13 or C13) to speakers to hear octaves.

3) **"Bow" Type Attacks** This is a remarkable trick, depending on the fact that the Modulator is AC coupled (has capacitors in the input circuits). The result of this is that at very low frequencies all inputs are differentiated and/or phase shifted (don't worry if you don't understand that explanation), and that a DC has no effect at all. The capacitor is sensitive only to a *change* in the input voltage, and the more rapid the change the greater the final output.

Pin Oscs. 1 and 2 at E1 and E4, and the Joystick at I15, J15 and F16 (for further description of Joystick see p.19). Set Joystick range controls at 6, and pin also the output of the Ring Modulator (B13). There will now only be a sound when the Joystick is moved, and if the Oscillators are tuned to a concord somewhere in their mid range (5-6 on the dial), you can 'play' the joystick as if it were a bow. 'Bowing' is up and down, and pitch changing from left to right. Specimen Patch 4 (Section VII) gives a more elaborate version of this, with 'bowing' also contributed by the Trapezoid Output (see Envelope Shaper). Try also slow square and ramp inputs – you can produce various plucked and struck types of sound.

4) **Bell Tones** The natural bell sound is complex, and the Ring Modulator will produce very complex outputs if the inputs are themselves rich in harmonics. The best results are obtained by using fairly high frequency inputs and combining low difference tones with very high summation tones (the difference tone can of course be very low even though both inputs may be very high or supersonic). The actual 'stroke' is made by the Envelope Shaper (q.v.), and can be set to 'toll' or 'tinkle' whichever sort of sound is required. Tune Oscs. 1 and 2 to about 7.5 on the dial, and use the sine output of Osc. 1 together with both outputs of Osc. 2. Pin E1 and F3, F4. Connect the Joystick to I16 and J15 (range controls at 4). Take the output of the Ring Modulator to the Filter, Envelope Shaper and Reverberation (B14, C12, D10, G10, H13). The best filter Frequency position is probably about 7, Response O, Output 10. On the Envelope

Shaper set Attack and On at O, Decay at about 6 and Off about 3; Reverberation Mix at 5 and level at 10. Now move the Joystick for different bell-like tones and also adjust filter Frequency and Decay for different effects.

These are a few examples of Ring Modulator technique. Many of the Patches in Section VII make use of the Modulator, and will give you further experience of its use. Ring Modulation has unfortunately gained for itself a reputation for harsh, distorted sounds, and this is in fact the usual result when a primitive transformer and diode device is used. We hope that the above examples have shown some of the great variety of useful sounds obtainable with a good design.

#### FILTER/OSCILLATOR

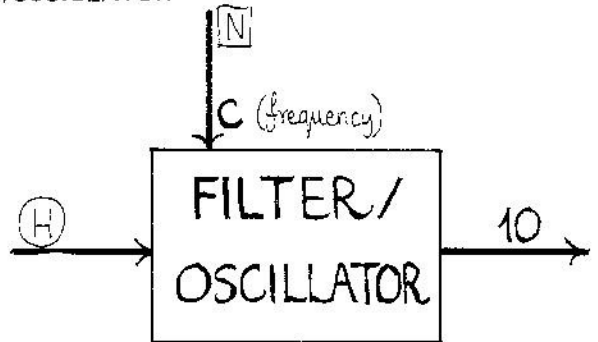

A Filter does exactly what its name implies – it removes some of the frequency spectrum from any input presented to it, by cutting off some of the low or high frequencies, or both. The more complex the input, the more drastic the effect of the Filter can be. There is, for example, no point in filtering a sine tone, because only one frequency is present in any case. At the other end of the scale, a complex, jagged waveform can be refined to an almost sinusoidal condition by filtering out all but its fundamental frequency. Or the fundamental can be ignored, and some other part of its harmonic structure can be selected.

The type of Filter fitted to the VCS3 enables you to select a very small portion of the spectrum, rejecting all the rest. To know what its characteristics are at a particular moment, we need two pieces of information – the frequency at which the acceptance of signal is most efficient (the *centre frequency*), and the extent of acceptance on each side of this point (the *bandwidth*). The VCS3 filter has an asymmetrical bandwidth characteristic. When the Response control is fully to the left it behaves as a *low pass filter*, which means that response is normal up to a certain point, after which it rapidly falls away. As the control is turned to the right the bandwidth contracts from the low frequency end until the filter has a sharp peak at a frequency determined by the Frequency Control.

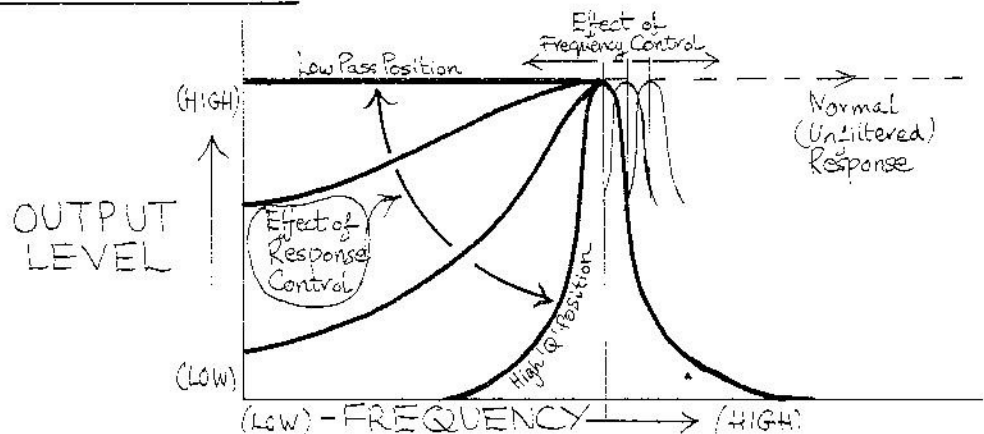

The sharpness of the peak, or selectivity, is known as *the 'Q'*, and so we refer to the *low pass position* (Response control fully left) and the *high-'Q' or Resonator position*. This will be at about 5-6 on the Response dial, and at some point around here the filter will begin to oscillate. This is its second function — a very pure sine source, in fact the purest sine tone available in the studio. The actual oscillation point will vary slightly with the frequency setting, and you should try this out with your own VCS3 (pin in B10). Set the frequency control about halfway. Advance the Response control until oscillation begins. Take it back until the oscillation just stops and then check that it doesn't oscillate at a higher frequency setting. A little practice will determine the highest setting for the Response control which gives high-Q without oscillation anywhere in the range.

For an exercise, tune Osc.1 to a fairly low note, and put its ramp output through the Filter (H2, B10). Then sweep the filter frequency with Osc.3 set to a rising ramp (N6 and Osc.3 shape control to the right). With some adjustment the filter will extract the separate harmonics from the ramp waveform and a natural series will be heard. The filter has a profound effect both on tone and noise (try this as well). If the frequency setting is below the fundamental offered to the filter no output at all will be obtained, of course, and until you are used to it this can produce puzzling cases of disappearing signals. As with the ring modulator, the filter in the VCS3 is very efficient, and the total disappearance of the signal when off tune may be a surprise to those used to less perfect designs. This effect is most marked when the input is a sine wave, because with no harmonics to filter an output will only be obtained very near the correct centre frequency point.

**Controls (L to R):**

**Frequency** (large knob) Covers the whole sonic range either as the filter centre frequency or the oscillator, depending on the function being used.

**Response** Fully left is the low pass position. At some point a little over halfway the high-Q position becomes the oscillator position, and the device will continue to oscillate at points further to the right.

**Level** Output available at Row 10.

Several of the specimen patches in Section VII make use of the Filter, and you will find it invaluable for shaping tone and noise to what you require. The voltage control is of frequency, and by sweeping the filter frequency the timbre of a note can be continuously changed. If the Filter is oscillating, the voltage control operates in exactly the same way as the controls of the three Oscillators, and this pure sine source is particularly useful as one of the inputs to the Ring Modulator. When you have studied the next

description (Envelope Shaper), try applying the Trapezoid output to the Filter while a tone is being routed through the Filter and the Envelope Shaper. The timbre of the note will change throughout its length.

In general, you will get best results from the Filter if the input is rich in harmonics, so it often a good idea to use both Oscillator outputs together, or even a whole group of outputs from several oscillators, either in unison or arranged in a chord.

There are occasions when you will want to use the Filter as such while it is also oscillating — it then becomes a variety of modulator with a built-in second input. Effects like howling wind, for example, result from mixing a noise input with the oscillatory output of the filter.

**ENVELOPE SHAPER**

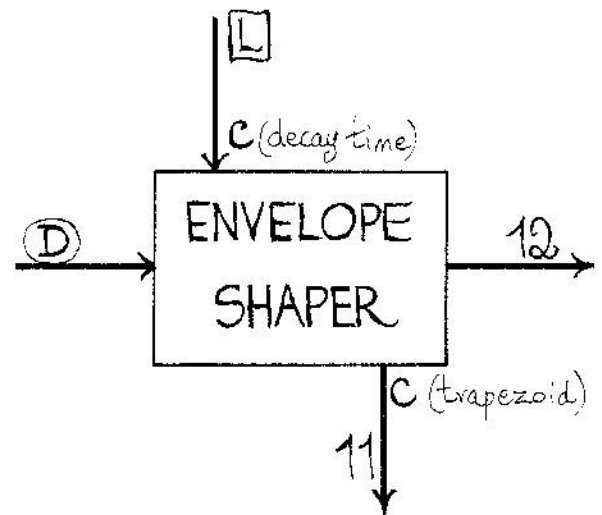

This is a complex unit, and its main controls are concerned with time. Its primary function is to generate a *shape* for a sound. For example a plucking type of sound must start very quickly and immediately begin to fall away, but much more slowly than it started. Or you may require a rapid crescendo at the beginning of a note, then to hold it steady at a certain level, finally letting it fall off slowly to silence and after a few seconds automatically repeat itself. Within the limits of its time controls, such a cycle can be set automatically on the Envelope Shaper.

There are six controls associated with the device, and we will consider first the four on the top row. These are all concerned with time, and the following sketch illustrates their function.

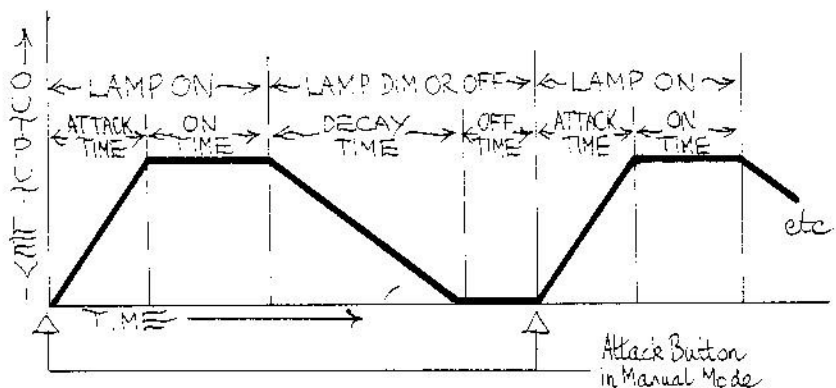

In most cases these times are quite slow (a second or more), but it is possible to produce a cycle fast enough to generate actual tone at about 60Hz (all four controls at zero). This will sound not like an envelope but modulation. At the other end of the scale the longest self repeating cycle is about 20 seconds (.05Hz). This is with Attack, On and Decay at 10, and Off about halfway. Further to the right Off becomes a permanent state next time it is reached, and the cycle must be reactivated by the Attack Button on the lower panel. This is the Manual mode, in which you set up the kind of attack you require and press the button whenever you want to hear it. The only need for practice is in managing short attacks in the Manual mode; the On state will continue as long as the button is held down, so a rapid release is necessary if a short sound is required. When the button is released, the Decay occurs at whatever time has been set. The small red indicator makes quite clear when each half of the cycle begins — bright for Attack and On, dim for Decay and Off.

A special case exists when the Attack time exceeds the On time, and in this event the decay will operate before the Attack has finished. Gentle undulation of level can be obtained in this way. Lengthening the Decay time, on the other hand, will not have quite the same effect — the On cycle will not fire until the voltage has reached a certain level.

With a little practice a wide variety of automatic and manually triggered shapes can be obtained. Experiment with various types of sound (in at Row D, out at B12 or C12).

The control parameter selected for this device as the most useful one is the Decay Time (L). Since altering the Decay time also affects the firing of the next On cycle, a control applied to this point will not only change the shape of the note (more or less tenuto) but also the whole repetition rate of the cycle.

There are two outputs, and it is important to distinguish between them. The normal signal output (Envelope Signal — 12) is the end product of the signal put in at (D) with the desired shape applied to it. The Trapezoid Output

(11) makes this shape available (without the signal it may be shaping, or even in the absence of a signal) for whatever control purpose may be needed. You will find this waveform very useful as a control, and the interactions of this with the other very slow waveforms available (from Osc.3) can produce non-repeating events over a surprisingly long period. As a simple example, try adding to the experiment above by applying the Trapezoid output to the frequency control of whatever tone you were putting through the Shaper. There will now be an upwards glissando as the note begins, and a downwards one as it decays. The diagram below illustrates the action of the two outputs:

**Controls (L to R):**  
(upper panel)

**Attack** Varies the crescendo time of the note, from almost instantaneous (2mS) to 1 second.

**On** Variable from 0 to 2½ seconds. Attack and On are slightly interdependent, which can produce effects like that mentioned above, when Attack time exceeds On Time.

**Decay** From almost instantaneous (3mS) to the very long time of 15 seconds. These very long decay times are in effect slow diminuendos rather than the normal decay of a sound.

**Off** The first half of the control settings lengthen the automatic off time from 10mS to about 5 seconds. At some point between 5 and 7 the cycle becomes non-repeating and must be activated by the Attack Button. This point depends to some extent on the Decay setting — if this is slow, the Off control must be further to the left to achieve an automatic cycle.

**Envelope Signal** Level of signal output available at Row 12.

**Trapezoid Output** Level of control signal available at Row 11.

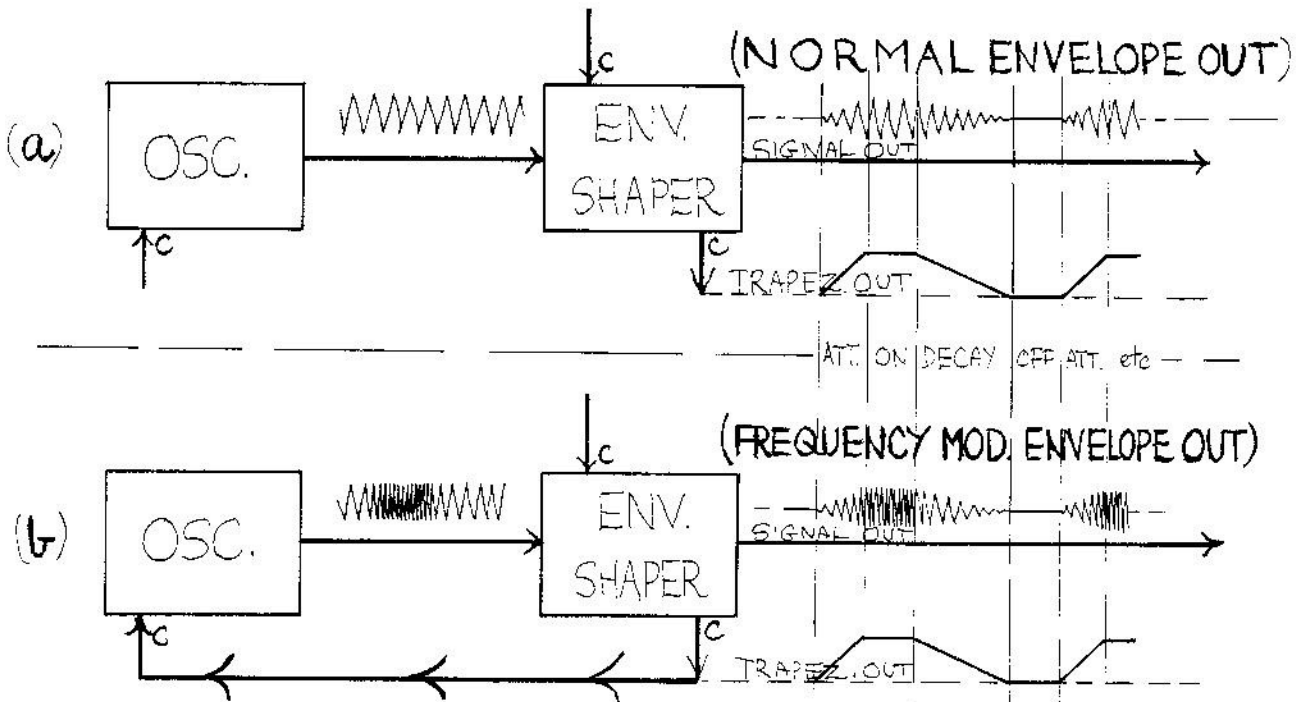

(lower panel)

**Attack Button** To the right of the joystick. Used to initiate the cycle in the Manual mode.

To experiment, plug a pin at A11 so that the trapezoid shapes can be seen on the meter (meter to Control Voltages). Apart from trying different envelopes on different types of signal (some interesting percussion effects can be obtained with filtered noise), try the effect of applying the trapezoid output to different controls. For example if you are filtering a tone and putting an envelope on it, you can also change its timbre as the note proceeds by putting the trapezoid control on the filter frequency (N11), as we suggested in the description of the Filter.

One final point to remember is that when attack and decay times are set at minimum, the trapezoid output becomes in effect another slow square wave source. By combining square waves from Osc.2, Osc.3 and the Trapezoid and putting them all on Osc.1, patterns of notes can be made to produce a large number of interesting rhythms.

Special effects include a 'bounce' which speeds up or slows down, achieved by applying Osc.3 ramp to the Decay control (Specimen Patch 5, Section VII), and the 'bowing' effect mentioned under the Ring Modulator (Patch 4, Section VII).

See also the Output Amplifier description, where a point is made that an *inverted* envelope is possible if the Trapezoid output is applied to an Output Amplifier control.

## REVERBERATION UNIT

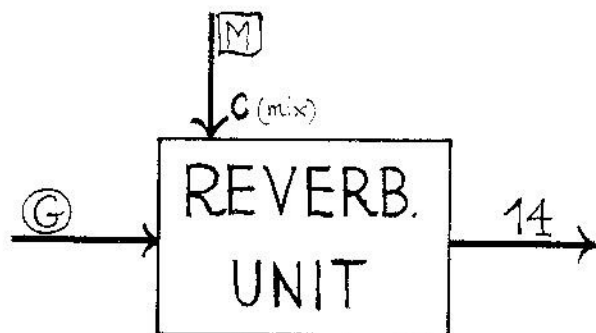

This device is partly electronic and partly mechanical, consisting of two springs in light tension, driven at one end by an electro-magnetic transducer. A similar arrangement acts as a pick-up at the other end and takes the signal off, by now delayed and reiterated by the travelling and standing wave patterns generated in the spring. When reverberation is being used you will hear the signal faintly even if there is no output amplifier connected. This is because it is possible to hear the spring itself vibrating. It is located under the lower panel just below the pin stowage, and accidental knocks here will cause the spring to vibrate and produce a noise even if there is no input connected.

Reverberation aims to simulate the effect of a natural enclosure with multiple path reflections. Echo devices, on the other hand, produce definite repeats of the signal at one or more fixed repetition rates. There is no provision for this in the VCS3, but single echo effects can be obtained on most tape recorders by using head feedback.

Because the die-away is part of the character of the reverberated signal, it is commonly connected last in the chain before the output amplifier, but it can be connected anywhere, and it may be used not for its reverberation effect as such, but as a kind of acoustic blender. Because of its delaying effect, events which occur in rapid succession can be heard simultaneously, and this tends to make a complex sound more homogeneous. On the other hand, spring reverberation inevitably degrades the signal, and there is considerable loss of definition and high frequency

Care should be taken not to overload the spring, which will cause distortion. If this occurs, the level control of the previous stage(s) should be reduced and the reverberation output level advanced. The more reverberation used (Mix Control further to right) the less defined the signal. When using the internal speakers it is also possible to set up an acoustic feedback or howl, and this is unfortunate but unavoidable in such a small cabinet. A very small reduction in Mix will stop it, and it will not occur at all when external speakers are being used.

Although Reverberation can be used with continuous signals, when it will blend and filter as mentioned above, it is normally most effective on sounds that stop and start. Experiment, for example, with a ring modulated tone (say Osc.1 and Osc.2 into E2 and F4), and follow this with the Envelope Shaper (B13) and the Reverberation Unit (G12, B14). Set Osc.1 and 2 frequencies fairly high — about 6 or 7 on the dial. If you set the Shaper to repeat about once a second, with short attack and fairly short decay, and set reverberation mix about halfway, you will be able to produce a variety of bell and clang tones. If you connect the joystick to Osc.1 and Osc.2 frequency (I15, J16) you can change the clangs by moving the joystick. A patch of this type has already been given in the Ring Modulator description.

The voltage control input (M) alters the proportion of direct to reverberated sound heard at the output — in fact it performs automatically the same function as the Mix Control does manually.

### Controls (L to R):

**Mix** Proportion of direct to reverberated output. Fully to the left, there is no reverberation, and the device is simply an amplifier. Fully to the right, nearly the whole of the signal is heard via the springs.

**Level** Amplitude of mixed output available on Row 14.

In electronic music, reverberation often has a different function from that of simulating an acoustic environment. Apart from its effect as a blender and filter, it assists in creating a positional illusion. A reverberated sound seems further back from the listener than a hard-edged, dry sound. In conjunction with the pan controls it is possible to make sound move back as well as from left to right by adding reverberation during the pan. The effect of this must be tried out in a given space if it is to be used for live performance, but the electronic composer often thinks in spatial relationships as well as in tonal and rhythmic ones, and reverberation is one of the techniques he can use.

## OUTPUT AMPLIFIERS

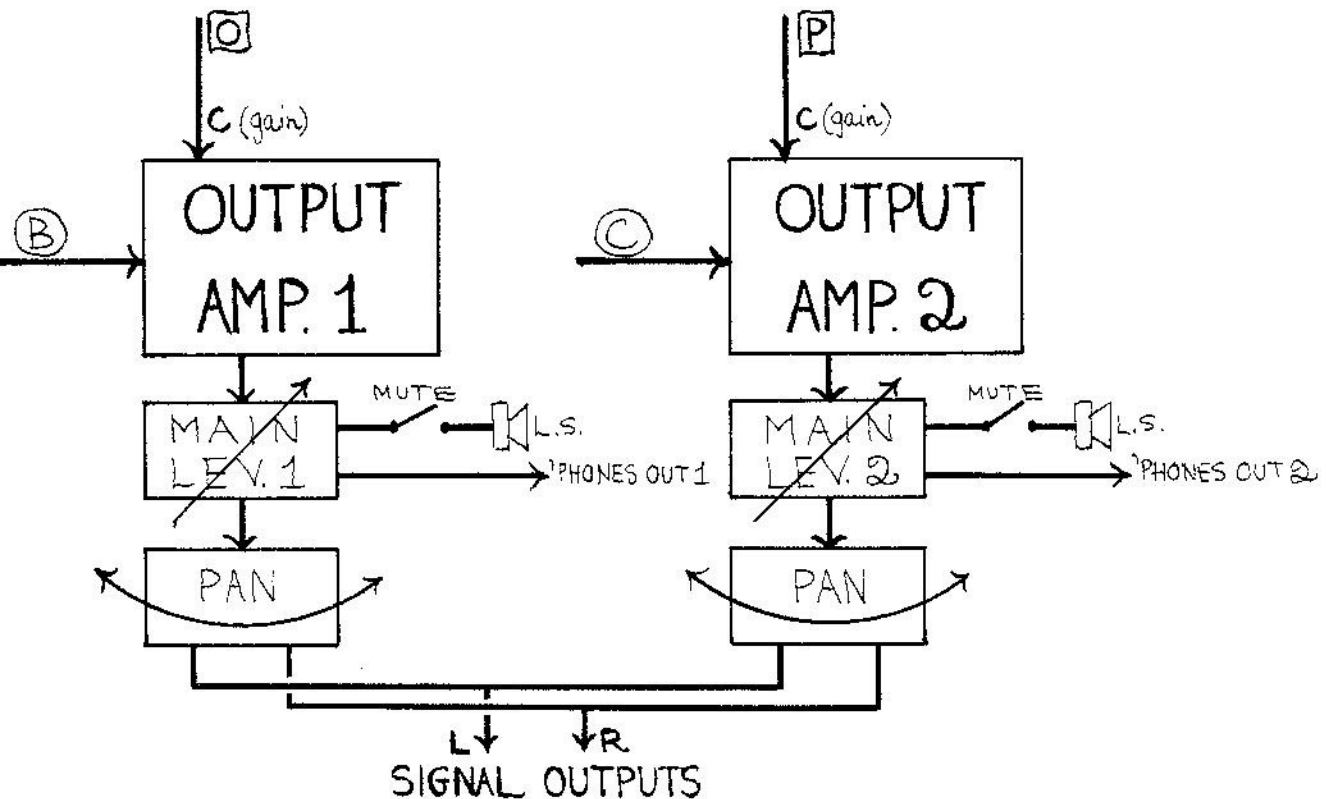

These are the essential links which connect the signal either to the internal speakers (via 1-watt final amplifiers), or out to external equipment by one of the sockets at the rear of the studio — or of course both.

In many cases you will use them simply as amplifiers, and any patch must eventually arrive at Rows B or C. The main level controls are the large knobs on the lower panel, but these do not operate quite as normal volume controls. They operate the voltage control function of the amplifiers, and when no other voltage control is added to Rows O or P you will usually have to turn the knob about halfway before the signal appears. But when another control is added the first half of the track will often be used to back the other control off — in fact it is possible to have settings at which the signal cannot be cut off at all.

The two controls on the upper panel (Output Filter) should normally be set halfway (at 5) for a flat response. Turned to the left they cut top and to the right they cut bass. This allows a modest final tone control of the signal. They are not narrow band filters like the Filter/Oscillator circuit. *It is important to remember to set them back to 5 when making a new patch, because they will affect any signal going through the studio.* They should be adjusted last, and in a live performance they will often help to 'tune' the studio for a particular acoustic environment.

The muting switches must be up if you wish to hear the internal speakers, but when the VCS3 is used with external amplifiers they are usually switched off (down), unless the studio is feeding a remote location and the internal speakers are wanted for local monitoring. Do not overdrive the local speakers, which are only 5". They give a very good account of themselves considering their small size, but they will give you a false idea of the output if driven into distortion. For the output jack plug connections see Section 1 (Specification).

The output amplifiers can also be voltage controlled, and as a simple initial exercise in amplitude control try plugging Osc.1 to both outputs (say B1, B2, C1, C2 — to give waveform control), plugging Osc.2 ramp to Ch.1 Control (O4) and Osc.3 ramp to Ch.2 Control (P6). Now set Osc.2 at minimum (about 1 Hz) and Osc.3 to the same frequency (this will be about 6 on the dial and you can plug meter to both (A4, A6) to tune out the beats — only remove pins afterwards to prevent interconnection). Set Oscs. 2 and 3 to the symmetrical position (triangle). Turn up both main controls and Oscs. 2 and 3 ramp level controls to give a wide range of fade. If you now slightly swing the frequency control of either Osc.2 or 3, the tone will swing from side to side as the two oscillators, a little out of step, alternately reinforce and cancel each other's effect.

You can also try amplitude modulation by putting an audible tone on Row O or P. If you wish, you are now in a position to compare the aural effect of frequency modulation, amplitude modulation and ring modulation with the same pair of frequencies. Try the difference between modulating pure tones (Osc.1 sine symmetrical and Filter as Oscillator) and richer waveforms.

A very interesting experiment is to compare the performance of the ring modulator and the output amplifiers at very low frequencies. You will find that a very slow square wave (about one every four or five seconds) on the output amplifier simply switches the signal on and off (or soft and loud depending on level applied). With the ring modulator, however, this waveform only 'opens the gate' at the moment of rapid change — it is insensitive to the steady state existing during the main part of each half cycle. The reason for this was discussed in the description of the Ring Modulator, and the very short bursts should be compared with the effect of the Output Amplifier. To hear the two effects together, plug B1, C13, E1, F5 and O5.

The output amplifier is also in effect another envelope control, because the trapezoid output can control the output amplifier. *But it operates in reverse* — i.e. the attack half cycle causes a fade and vice versa. So another method of swinging the signal is to put one side through the envelope shaper and control the other side by means of the trapezoid on the output amplifier (plug B1, C12, D1, O11). Don't forget also the possibility of Joystick control.

## Controls

### (Upper Panel)

**Channels 1 and 2 Output Filters** Bass or treble roll off with flat central position.

**Muting Switches** . Up to operate internal speakers.

### (Lower Panel)

**Main Level Controls** Level available to feed speakers or outputs. This output does not appear on the matrix board.

**Pan Controls** These operate only on the low level outputs, which are the ones normally used to supply external amplifiers or speakers. The effect will not be heard on the internal speakers. Normally (but not necessarily always) one would think of Channel 1 as left and Channel 2 as right, so keep the lefthand Pan Control at 1 and the righthand one at 10 as a general rule. In performance or recording the channels can be crossed, both brought to the left or right, or panned across as desired.

To make a Control Voltage available externally, use one of the Control Output Sockets, having connected the required Control to one of the Output Amplifiers.

In the other position (Signal Levels) it becomes an AC meter reading from zero, and can be used for noting and logging sound levels. You can make sure, for example, that the two inputs to the Ring Modulator are equal in value, if this is what you require.

You may sometimes use the two states of the meter at different frequencies of the same output. To demonstrate this, Switch Meter to Control Voltages, plug to A3 and turn Osc.2 to zero. Turn up the square output of Osc.2 until the needle gives a large flick each way (Method 1 for tuning for symmetry — tune for even flicks each way). Now if you increase the frequency the flicks begin to run together and decrease in amplitude — not because the signal is swinging less, but because the inertia of the meter movement makes it unable to keep up with the changes. Eventually it settles down in the middle, and varying the square output level makes no difference — because it is reading an *average*, and the net average of a symmetrical plus-minus signal is zero. This is Method 2 of tuning for symmetry; note the zero point of the meter, which may not be quite .5, and with signal fast enough to hold the pointer still, tune shape control until the pointer shows exactly this point — for average = zero.

With the oscillator still at the new higher frequency, switch to Signal Levels, and you can read the level of square output from Osc.2 arriving at Row 3. If you now reduce the frequency again the needle will again flicker, but since it is not centre zeroed it will swing against the lefthand stop and give unreliable readings.

**WARNING:** Connecting more than one signal to the Meter will effectively join whatever signals are plugged, which will sometimes give puzzling results, since it will amount to unwanted patching. So although you may want to look at the shape of several controls together in order to check, remove all but one pin from Row A before listening to the result.

## METER

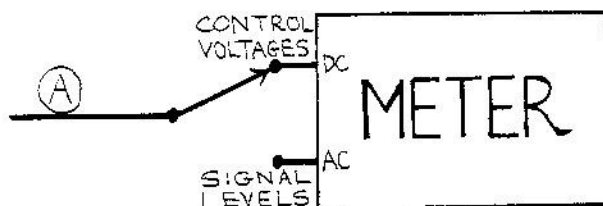

The meter does not in itself affect the operation of the studio; it is neither a Source nor a Treatment, but an Indicator or Monitor. It has two states, selected by a switch, and any hole on Row A plugs the appropriate output to the meter. With the switch up (Control Voltages), the needle settles down at or near the middle of the scale. It is then a centre zero DC meter, and 0.5 on the scale means 0 volts. It will read the slow control phenomena, and indicates whether the signal is negative or positive. With practice you will be able to judge the shape of a control waveform from the movement of the needle (the steeper the wavefront, the sharper the kick of the pointer). In a performance, for example, you might need to check the Trapezoid waveform before plugging it to a control, to make sure it is correct. You have noted beforehand that the swing should be between .2 and .8, and you can check the attack, on, decay and off times with a watch. Don't worry about the *absolute* value, or the apparent reading on the meter (which has a nominal full scale deflection of 1 mA), because it is intended for indication and logging rather than precise measurement. If you do require them, conversion values are given in the Specification (Sect. I).

## MATRIX BOARD

This has already been described in Sect. III, but the following further remarks may be helpful:

(1) The pins are as strong as can be made, but obviously their small size makes them liable to damage if handled roughly (the shaft is a tube, not solid metal). Do not bend them sideways, and if the top comes unscrewed for any reason, screw it up tight. Never patch with damaged pins, which can bend the contact leaves of the board.

(2) You can to some extent preset a patch by inserting pins halfway and then pushing several home at once. Most functions can be switched in this way without a noise, but some will click (e.g. reverberation out to an output amplifier).

(3) We can supply spare pins, and it is not recommended that you obtain pins from another source, in case they are dimensionally different. There are several different designs of matrix board, and the wrong type of pin can irreparably damage the board. VCS3 pins must also be fitted with a 2.7Kohm resistor.

(4) Try to prevent dust and grit entering the holes in the board. Large particles are almost impossible to remove, and if the studio is being stored for some time it is a good idea to tape a piece of paper over the board. Occasionally use a miniature vacuum cleaner if available.

## MAINS ON/OFF

Self-explanatory. If the red light fails to glow, check that (a) the mains lead is not defective, (b) the fuse at the back of the studio is intact. It is just possible that the indicator itself is defective, but unlikely because the neon lamp should last indefinitely. For instructions on how to change the Mains Tapping, see Section I (Specification).

## JOYSTICK

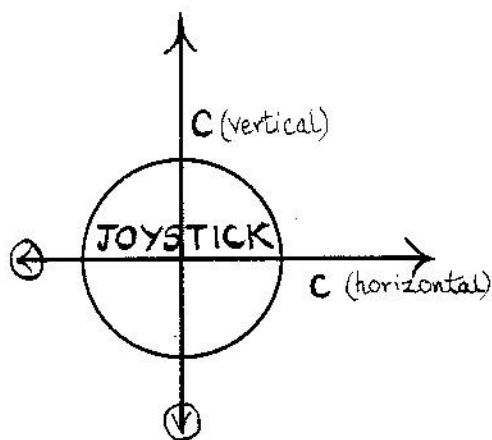

Although the mounting is round in shape, the actual movement is in a square, and with a little practice one parameter can be altered without affecting the other. Negative to positive change of both voltages is achieved by moving the stick from bottom left to top right.

The joystick can be plugged to any of the Control inputs, but will not be effective on Signal inputs. So although 32 holes appear to refer to the joystick, except in the special case of Ring Modulator 'bowing' (q.v.), only 16 of these are actually effective.

You can select any two controls, or link several together — such as a chord on Oscs. 1, 2 and 3, of which all the pitches can be moved simultaneously. The other direction of the stick could be filtering, or level, or both. Experiment for yourself.

Practice is required to set up the Range controls correctly, and to use the stick precisely. With the Range controls at 0 the stick has no effect because no control voltage is applied. At 10 the effect is at maximum.

Suppose you wish to control two frequencies over a definite range. Connect Osc. 1 in the usual way (B1 and 2), and put a pin also at I15. This is left-right stick movement. Set the left-right range control to about 5, and move the stick across and back several times, noting the interval given by the extremes of position. By adjusting the range control you can make the movement cover any range you like. You can then adjust the manual frequency control to make the range you have chosen begin and end at the pitches you want. The VCS3 is so designed that if you have set the range to (say) an octave, an octave should still be produced at all settings of the oscillator frequency. Now set up the range of Oscillator 2 in the same way, using up-down movement. It is now possible to produce any two-part chord within the limits of the two ranges set, at some position of the stick.

The Joystick is often useful in trying out a patch, to see what the effect would be of altering one of the controls. Having tested the result on the Joystick, you might then reset a manual control and take the stick out of circuit. Try different combinations of stick control, and if you are controlling several parameters at once, try the effect of different groupings of these parameters on the two stick movements.

We have already mentioned in the Ring Modulator description how the Joystick can be used almost as a bow, and nearly all the Specimen Patches in Section VII show the stick connected. Although its effect is often dramatic, particularly if the range controls are set high, it can also be adjusted to make subtle changes of pitch, level, timbre, envelope or reverberation. In a live performance, for example, it can be preset so that certain known changes will take place as the stick is moved from (say) top right to top left and then down to bottom left.

## ATTACK BUTTON

Already described under Envelope Shaper. Don't forget that this button can be operated with the little finger of the right hand at the same time as the Joystick is being used, leaving the left hand free for other adjustments.

## OUTPUT LEVEL AND PAN CONTROLS

Already described under Output Amplifiers. The Pan Controls are available only at SIGNAL OUTPUTS jack sockets. In most cases the Pan controls should be left at 0 and 10 respectively on left and right, so that external equipment corresponds with the internal speakers unless otherwise adjusted.

# V— External Equipment and Special Patches

On the following pages we describe some methods of using the VCS3 with other equipment, and some special patches which involve the jack sockets at the back of the studio. We would emphasise that the more complex the circuit, the easier it is to make a mistake. Do not plug any of the jack sockets to each other without thinking carefully first, and never connect peripheral equipment without taking the same precaution. If you are at all uncertain, always make a block diagram as in Section II, showing the complete Signal and Control paths, both inside the VCS3 and through any external equipment you may be using. Watch out for *positive feedback loops*, in which an amplifying circuit is fed back on itself. This causes an unstable situation which can result in howlback or temporary paralysis of a circuit.

## EXTERNAL EQUIPMENT

As discussed under Input Amplifiers (Section IV), the VCS3 can be used purely as a Treatment device, or as a combination of Treatment and Source. In this case we can represent the entire studio as a Treatment box.

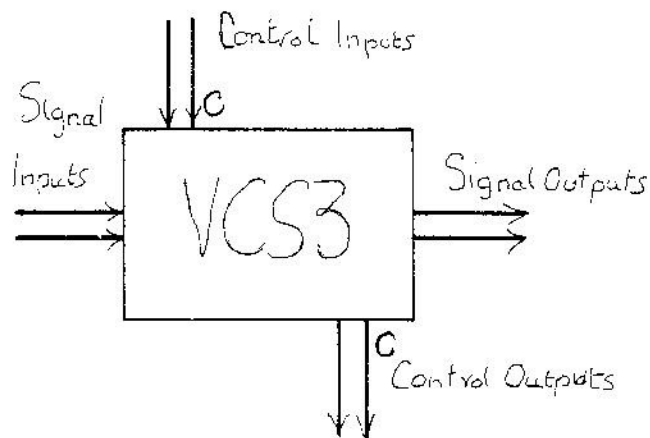

This is the best way to think of the studio when you are using external inputs. Here are a few examples:

## Example 1 External Signal Inputs

You might wish to modify a vocal or instrumental input in various ways. Connect a suitable microphone (600 ohms or more, or low impedance with a transformer) to MIC INPUT 1, and start with the Input 1 level control at zero. Connect the output amplifiers to external amplifiers and speakers, and plug the signal straight through (B8, C8) to check that the untreated signal is satisfactory. Adjust the input and output level controls so that a clean, undistorted result is obtained. Already one treatment is possible — you can pan the signal from speaker to speaker.

But having brought the signal to Row 8 you can now treat it exactly as you would an internally generated signal. Possible modifications of the original sound include:

- Reverberation
- Ring Modulation (using an internal second input)
- Applying an Envelope to it
- Chopping or other shapes of amplitude modulation applied to the Output Amplifier
- Channel switching and panning automatically
- Filtering
- Any combination of the above automatically changed about

Any of these treatments can be applied as constant effects or made subject to internal voltage controls (e.g. the Filter or the second input of the Ring Modulator could be swept). You could have different sorts of treatment on the two outputs, panning them as desired, or keep one untreated.

The other input could be used for a second microphone perhaps in this case a contact microphone, or for a tape or disc playback, or an external electronic signal. For example a prepared tape of electronic music can be further treated as part of a live performance. (N.B. The inputs are not suitable for direct feed from a tape head or pick-up, because no provision is made for the essential playback equalisation).

If hum is experienced when using external equipment, one of the commonest causes is the "earth loop" or "ground loop". If both inputs 1 and 2 are connected to the same equipment (e.g. upper and lower track of a tape playback), the grounded screens of the leads make a closed loop.

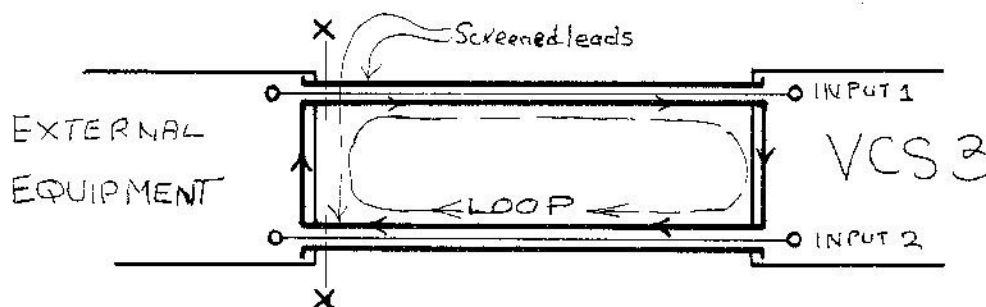



This loop can pick up induced hum (there is always a plentiful mains field about) and affect the signal. The best cure is to break the loop somewhere (usually at one of the points marked with an 'X'), but not of course on both sides, or there will be no circuit. When the VCS3 is part of a large complex, it may be advisable to disconnect the mains earth at the plug, because if other parts of the equipment are also grounded to mains it is possible to make a long loop through the house wiring system.

Although in the above case it would be possible to derive the necessary voltage from the Keyboard socket, a battery is the simplest method of remote operation, because long power leads are always a potential source of trouble. This type of control can easily be extended — for example you can have a number of switched preset potentiometers — to give all sorts of control over any parameter in the studio, or a foot pedal. This is a matter for your own ingenuity.

### Example 2 External Control Inputs

If you have a second VCS3 or other voltage controlled studio, a control voltage can be brought in — usually through the normal HI-LEVEL INPUT jack sockets (see note on possible patching arrangements later in this Section). If the control frequency is in the audio range, any oscillator (not necessarily itself voltage controlled) can be used to control the VCS3, but for very low frequency control direct coupling (without capacitors) must be used or the intended waveform will be differentiated and probably useless (a square wave, for example, can become a row of short spikes). *Do not, however, remove output capacitors from oscillators without checking the standing DC on the other side of them.* In the case of a valve oscillator, there might be several hundred volts on the live side of the capacitor, and the whole experiment is best left alone if you are not certain about this.

Apart from *varying* control voltages, there is often a need for simple DC control of a signal, and this can be achieved without any elaborate circuitry — in many cases one potentiometer and a battery. We give a circuit in which the VCS3 is used as a remote fader, though of course other treatments could be set on it. We suppose in this application that you must have long lines between the fader and the amplifier (perhaps to the back of an audience), and to bring the signal itself would certainly lead to hum and loss problems.

### Example 3 Connecting Outputs to External Equipment

Normally it is a simple matter to connect the VCS3 to a complete amplifier with preamplifier, and merely involves a suitable lead or leads between the SIGNAL OUTPUT sockets and the high level inputs of the amplifier (usually RADIO). If there is no preamplifier you must find out what level of signal is needed to drive the main amplifier, and possibly fit the main amplifier with a gain control if it has none. If the amplifier is very insensitive it may be necessary to use the HEADPHONES jack, but you will lose the panning facility. Panning can, however, be carried out by manipulating the two Output Level controls, and in various automatic ways (see Sect.IV).

As we have mentioned elsewhere, low level inputs with built in compensation for pick-ups or tape heads are not suitable, and in any case there is an unnecessary amount of gain available, and you will find the signal difficult to handle, apart from the chance of further hum loops.

All the above remarks apply equally to a tape recorder, whose input arrangements are just the same as those of an amplifier. The maker's instructions will show the sensitivities of the various inputs in both cases.

Once the signal is in the amplifier chain, other peripheral equipment can be connected at any suitable point. The SCOPE socket can also be used for a frequency meter, and Volume Unit or Peak Programme meters can be

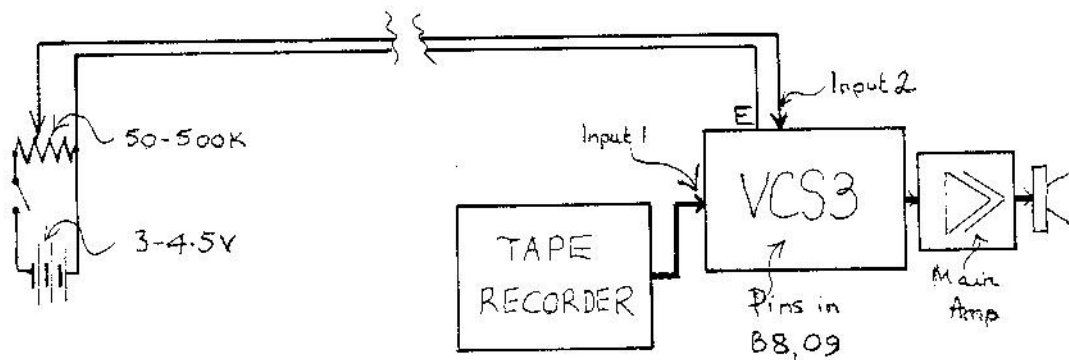

The value of the potentiometer is not critical, but a large value will give less battery drain. If the fader at first operates in reverse, change the battery polarity. The best setting is found by adjusting Input Amp.2 level and Output Amp.1 level to give a comfortable fade control. Make sure, also, that the Signal level (Input Amp.1) is correct for distortion free reproduction.

connected to the lines between the VCS3 and the external equipment (though these may need their own amplifiers). If the SIGNAL OUTPUTS are taken straight to an external patch and mixer, you may find it necessary to use line or make-up amplifiers to restore the signal level after mixing, but if you have a studio with this sort of equipment you will be familiar with these problems in any case.

A complete small studio set-up might be something like this:

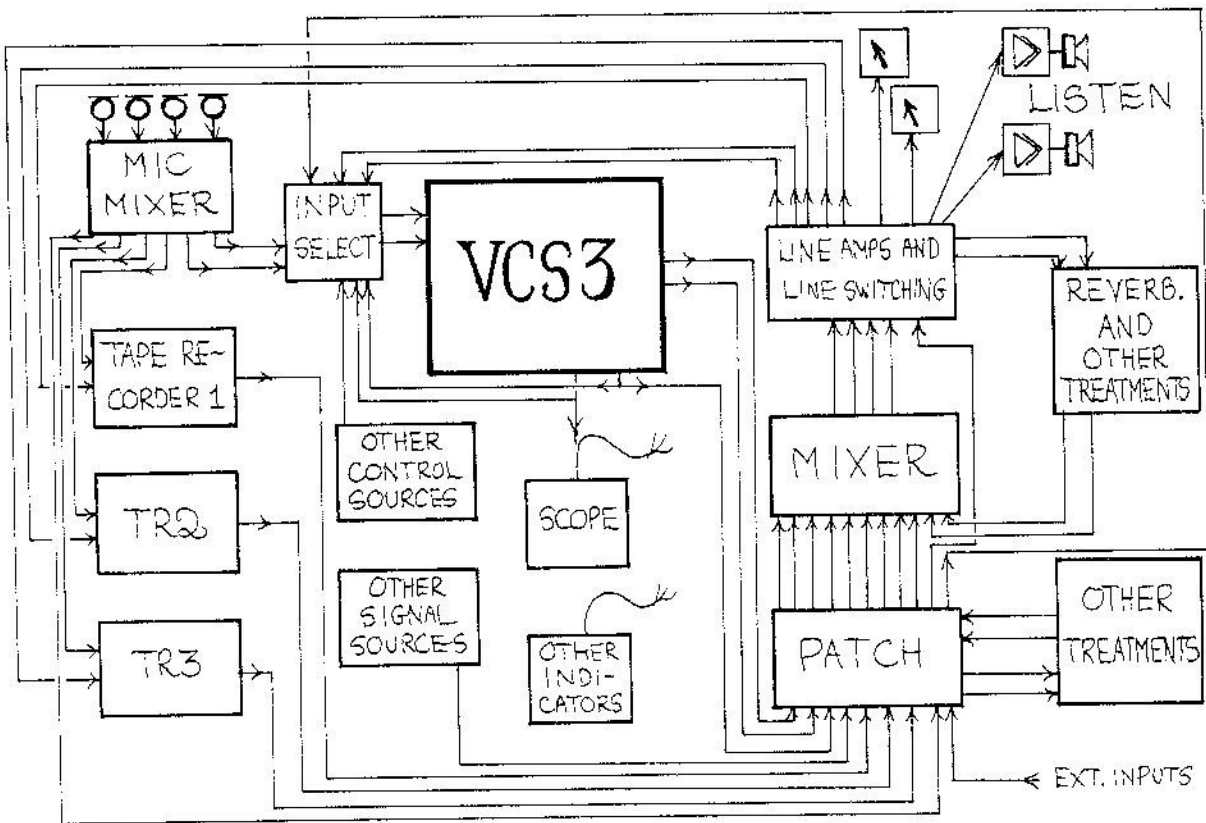

**SPECIAL PATCHES, NON-STANDARD CONNECTIONS etc.**

**A. Special Patches**

Although the jack sockets behind the studio are intended primarily for connecting it to other equipment, there are occasions when some of them can be connected to each other for special purposes.

Obtain four extra jack plugs and a length of screened cable, and make up two patch cords about 18" long, with a jack plug at each end. Join the cable core to the tips and the screen to the shafts of the plugs. You can now try the following examples:

**Example 1 Inverted Control Signal**

Connect one of the leads between the SCOPE socket and HI-LEVEL INPUT 1. As we have mentioned, (Specification, Sect.I), the SCOPE socket will see anything connected to Row A (which means also that anything at this socket will show on the Meter). The Input Amplifiers not only increase any signals applied to them, but also invert them. This is usually immaterial, but a slow control will appear in mirror image form if fed through these amplifiers, and this can be a very valuable facility. Specimen Patches 13 and 14 (Sect.VII) give examples. Patch 13 is a fairly simple exercise in scales, glissandi and arpeggi in contrary motion. Note that the ramps of Oscs.2 and 3 are connected to Osc.1 control and also to Row A. Via the connection behind the studio this control re-enters and appears at N8 in inverted form, controlling the Filter/Oscillator in the opposite direction from Osc.1.

Patch No. 14 is more complex, and in this case the inverted control is of rhythmic pattern as well as pitch (one side is slow while the other is fast, and vice versa). To test the result, remove pin at A6 and note the difference.

**Example 2 Two Inverted Control Signals**

Occasionally you may wish to invert two controls, and in this case one of the DC Outputs can also be fed back into the studio. This involves using one of the outputs for control, and therefore only one signal output is usable as such. Specimen Patch No.15 produces siren-like wails with swept noise accompanying them, moving in different directions in an apparently capricious fashion. Use the second patch cord to connect CONTROL OUTPUT 2 to INPUT 2, leaving the first cord also connected. The normal controls are Osc.3 and Trapezoid, and their inversions appear at Inputs 1 and 2 respectively. Various configurations of Rows 6, 8, 9 and 11 are applied to give different patterns – including the semi-cancelling effect of applying different amplitudes of the same control in opposite polarities.

**B. Joining Two Studios**

Two VCS3's are more than twice as powerful as one, because there are all sorts of new possibilities of control. To realise all these possibilities easily, it is a good idea to make

emergency any knob suitable for a 1/4" spindle can be used. If knobs are wrenched so violently that the whole potentiometer becomes loose, attend to it at once before an internal wire is broken. Take off the back, hold the potentiometer from behind and tighten the nut firmly. If the wires are already displaced check that none are broken and resolder if necessary.

- 5) **Matrix Board and Pins** Advice has already been given about these items in Section IV.
- 6) **Meter** If the pointer does not read zero when the studio is off, the zero can be adjusted with the small perspex screw at the bottom of the dial.
- 7) **Panels** Avoid any abrasive cleaner, and *never* use strong solvents like acetone, trichlorethylene or petrol (gasoline, benzin, essence). The best cleaner is methylated spirits (alcohol), but paraffin (kerosene) or turpentine can be used, though they tend to leave an oily deposit and often an unpleasant smell. Use wax pencil to mark the panels if you wish to do so, rather than lead, particularly hard lead, pencil. Do not use ball point, which may leave a permanent indentation in the finish, or fibre-tipped pens, which often contain an indelible stain.
- 8) **Switches** The switches respond to very light pressure, and should not be strained by heavy-handed operation.
- 9) **Storage** Solid state devices dislike sustained heat. Never leave the VCS3 in a sealed car in summer sun, or in a similar situation. For long term storage choose a cool, dry position. If it is not used for a very long time (a matter of years) there may be trouble with electrolytic capacitors when it is switched on again, and the best insurance against this is to run the studio for a few hours at least every few months.

## Getting Op Preset Controls

The miniature preset potentiometers on the printed circuit boards are all carefully adjusted on initial setting up, and should not need further attention. But in the event of components being replaced or accidental displacement of a preset, the following adjustments can be made, but only if proper measuring instruments are available. Adjustment to these small controls is best carried out with a plastic bladed screwdriver, but in any case be sure not to touch any other component except the preset you are adjusting. If you are doubtful consult an engineer, because rough handling can do a great deal of expensive damage in a very short time.

BOARD A (left hand looked at from back)

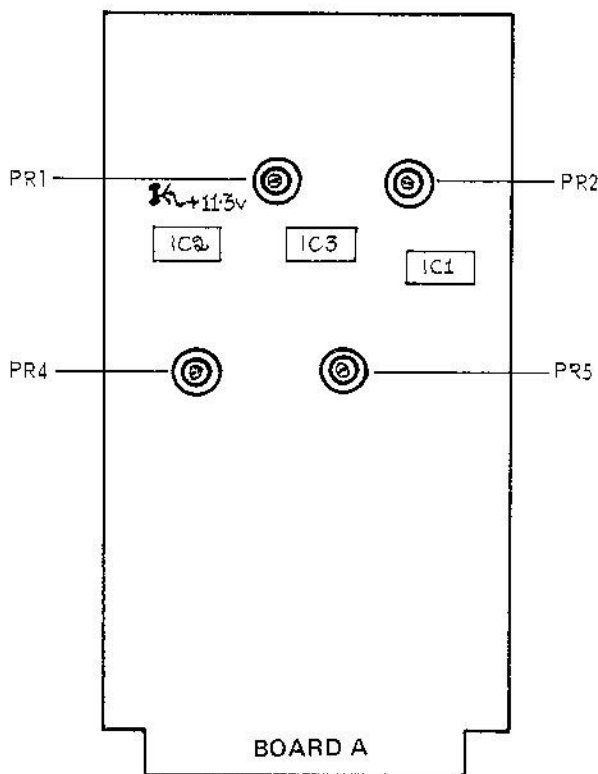

Board A contains: **Power Stabilisers**  
**Output Amplifiers**  
**Reverberation Driver Amplifier**

- PR1 (10 Kohms) Negative stabiliser supply voltage. Adjust for -9 volts on negative power rail (ground to Keyboard socket 2)
- PR2 (10 Kohms) Positive stabiliser supply voltage. Adjust for +12 volts on positive power rail (ground to Keyboard socket 4)
- PR4 (2.5 Mohms) Output Channel 1 zero level. Adjust for -70dB with level control knob at zero.
- PR5 (2.5 Mohms) Output Channel 2 ditto.

- DON'T connect unknown inputs with the input level controls wide open. Take particular care when connecting valve (tube) driven equipment to the VCS3.
- DON'T overrun devices constantly for hours on end. If the outputs are not connected, this can happen without the user knowing. The safest course is to remove pins when the studio is finished with for the time being.
- DON'T connect unknown mains supplies without checking.
- DON'T interconnect jacks at the back of the studio without thinking carefully first. Particularly take care if you connect the Keyboard Jones Socket, because of the danger of short-circuiting the supply rails.
- DON'T grossly overrun the internal speakers, which may be damaged and give unreliable results thereafter. They are *not* intended to fill a large hall, but to give an adequate performance to the user of the studio. For any audience application, connect to external power amplifiers and concert speakers.
- DON'T continue to use the studio if unexplained noises, heat or smells occur. Stop and investigate.

up a link board, using either another matrix board (with short-circuited pins) or a collection of conventional jack sockets (a "jack field") and patch cords such we made up for the previous experiments. The rear connections of both studios can be brought to the link board, and a typical set-up, using two 20-socket jack strips, would be:

Output Strip:	Input Strip:
1 Signal Out L	1 Hi-Level In 1 } VCS3A
2 " " R	2 " " 2 }
3 Control Out 1	3-6 Parallel
4 " " 2	7 External A 1
5 Scope	8 " A 2
6	9 " B 1
7	10 " B 2
8 Parallel	11 Hi-Level In 1 } VCS3B
9	12 " " 2 }
10 External Feed 1	13-16 Parallel
11 " " 2	17-20 Spare
12-16 Outputs from VCS3B	
17-20 Parallel	

It is best to plug microphones directly to the studio, because the fewer line connections there are the better, on a high gain line. The headphones jacks could be brought out to the jack field, but are probably as useful in their normal position.

The parallel sockets are very useful in a jack field, but would not be necessary if you used a matrix board, since parallelling is merely a matter of putting pins in the same row. Excessive use of parallels may, however, cause loss of signal due to lowering of the impedance, and in some cases hum loops may occur.

An arrangement such as the above enables all inter-connections to be made in a moment, and the full possibilities of inter-control and mixed signals easily realised. As mentioned at the beginning of this Section, the more complex the patch the more necessary it is to think carefully what you are doing. When in doubt, draw a block diagram sketch before trying out what you have in mind.

### C Open Pin Patching

Two terminal pillars are provided on each side of the pin storage below the Matrix Board. The purpose of these is to provide anchorage and a ground connection if you

wish to use the Matrix Board in the same way as you would a jack field — i.e. make external connections directly to it. The ground connection is necessary because the pins make only live connections, ground being commoned permanently to all circuits.

It is best to make two sorts of lead, one for inputs and one for outputs, or confusion may result, since it is important to know whether you are connecting to the vertical or horizontal row at a given pin location.

Unscrew a pin and carefully remove the 2.7Kohm resistor. Now take a length of screened lead and remove about 8" or so of the outer sheath. Unwrap (or unbraid) the screening, leaving the inner cable exposed. Connect this *either* to the tip *or* the shaft of the pin, making sure that short circuits cannot occur to the unconnected side (you can drill a hole in the pin cover and lead the cable through, or use an open pin). Shorten back the screening to about half an inch, and solder this firmly to a spade terminal (for clamping under the terminal pillar) or a banana plug (to push into the socket in the top).

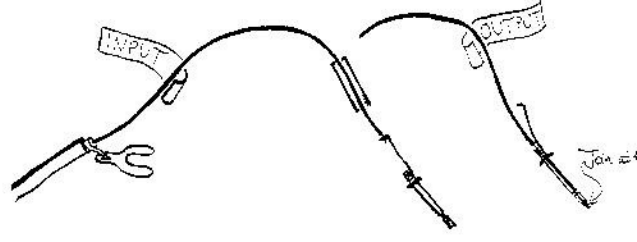

Leads connected to the tips of pins should be clearly marked OUTPUT, and those to the shafts INPUT. Or you may prefer to use a colour code for this.

It should now be possible to anchor the earth spade plug, and reach any hole on the board without straining the pin. Accidental jerks of the cable will pull on the terminal pillar (which can take it) and not on the pin and delicate leaves of the matrix board (which may not). The type of lead you use will determine whether the hole you choose is reaching the appropriate vertical or horizontal row.

As previously stressed in this Manual, we urge you not to attempt these special types of connection unless you are confident that you know what you are doing.

## VI—Maintenance and Faultfinding

### A General Care and Maintenance

The VCS3 could hardly be easier to maintain, because the solid state circuitry is designed to run well within its capacity, even under conditions of electrical misuse, and there are no mechanical parts except the Joystick. But the following general points may be helpful:

- 1) **Cabinet** Afrormosia wood is perfectly satisfactory without any special treatment, but can be oiled or polished if desired.
- 2) **Jack Sockets** These are of standard pattern, and extra jack plugs can easily be obtained. However there are some non-standard sizes on the market, and no plugs should be used if they are a very tight fit or on the contrary move too freely in the socket. They should
- 3) **Joystick** The grease in the control slots may eventually dry out, particularly if the studio is kept in a warm place. To service, remove the bottom panel, and take off the red cover plate of the joystick. Carefully clean the slots and ball joint, and relubricate with a *little* Vaseline or silicone grease. Do not allow any grease touch the potentiometers, and take care not to cross thread the self-tapping screws when replacing the cover.
- 4) **Knobs** Do not wrench controls violently against the stops at either end of the track. If knobs become loose, slacken off the set screw, reset at either maximum or minimum position, and tighten firmly. The spindles are nylon, and it is normal for the screw

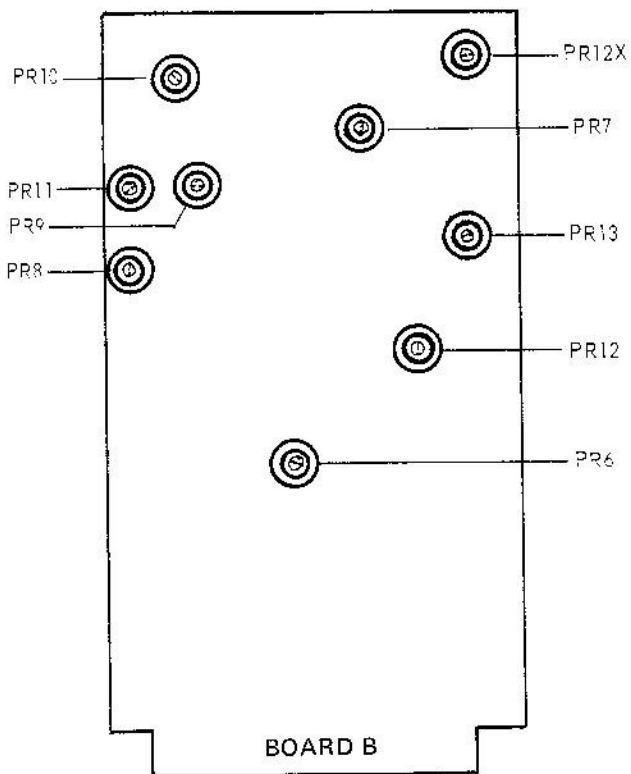

Board B contains: **Envelope Shaper  
Filter/Oscillator  
Ring Modulator  
Input Amplifiers**

- PR6 (100 Kohms) Filter frequency adjustment. Adjust so that filter oscillates at 260 Hz with panel control at 5.
- PR7 (10 Kohms) Filter intrinsic gain control. Normally set fully counterclockwise.
- PR8 (100 Kohms) Ring modulator input B fundamental rejection. With a 1V p-p sine wave to input A, trim this control for minimum breakthrough of fundamental.
- PR9 (100 Kohms) Ring modulator input A second harmonic rejection. With input as above to B, trim for zero breakthrough of second harmonic.
- PR10 (1 Kohm) Ring Mod. input A fundamental rejection.
- PR11 (2.5 Mohms) Ring Mod. input B second harm. rejection.
- PR12 (100 Kohms) Envelope shaper maximum decay rate. Adjust for decay time of 3mS with panel control at 0.
- PR12X (2.5 Mohms) Envelope shaper OFF level. Set PR13 clockwise, "OFF" panel control at 10, "DECAY" panel control at 10. Put large signal into envelope shaper and adjust PR12X to just get zero output.
- PR13 (2.5 Mohms) Envelope shaper "off" level. Having adjusted PR12X, turn PR13 slowly

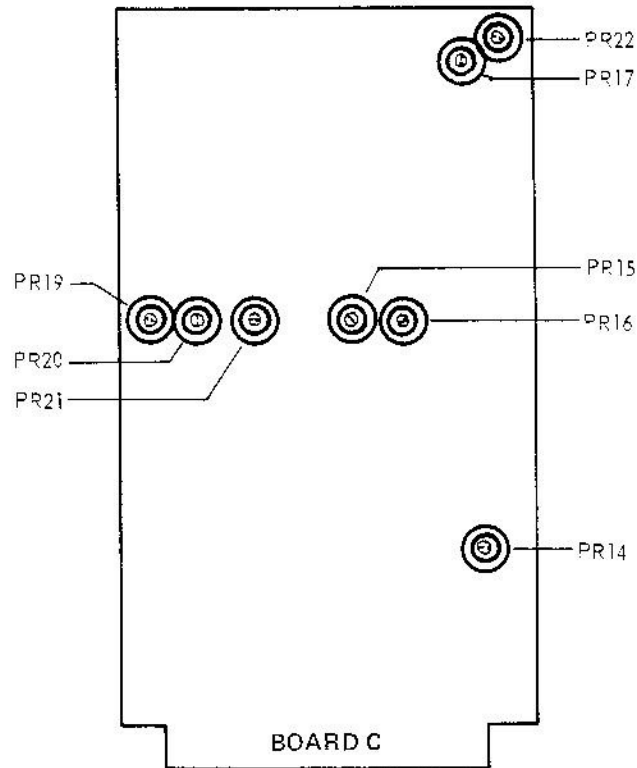

Board C contains: **Noise Generator  
Oscillator 1  
Oscillator 2  
Oscillator 3  
Meter Amplifier**

PR14 (10 Kohms) Meter amplifier DC zero. Ground the input to the meter amplifier, and trim so that meter reads 0.5 (half scale) when switched to Control Voltages.

PR15 (100 Kohms) Osc.1 frequency offset. Set frequency dial at 6 and trim to obtain 261.6 Hz.

**NOTE:** Do not attempt frequency adjustments without an accurate frequency meter.

PR16 (100 ohms) Osc.1 frequency control sensitivity. Adjust to get precisely 1.5 octaves per major division on frequency dial. Calibration points are

Dial	4	6	8
Frequency	32.7Hz	261.6Hz	2093Hz

PR17 (10 Kohms) Osc.1 sine purity (flyback suppression). Adjust for purest sine wave at about 400 Hz.

PR19 (100 Kohms) Osc.2 frequency offset. Adjust as PR15

PR20 (100 ohms) Osc.2 frequency control sensitivity. Having adjusted Osc.1 (PR16), apply the same control to Oscs. 1 and 2 (e.g. from joystick) and adjust PR20 so that both oscillators track perfectly in unison (listen for zero beats).

PR21 (100 Kohms) Osc.3 frequency offset. Set frequency dial to 10 and adjust to 500 Hz.

## Faultfinding

If you suspect that the studio is not operating correctly, first go through the following procedure:

- 1) Remove all peripherals to isolate the studio from any outside effects
- 2) Make sure the muting switches are up, output levels set high enough
- 3) Check the patch and control settings
- 4) Check the pins, and change them around. Reject any suspect ones.
- 5) Check that the mains connection is firm (pilot light glowing steadily)
- 6) Simplify the patch in order to isolate the device you suspect.

Very often you will find that there is no fault at all beyond a broken pin, but if you definitely suspect a particular device, try another patch using that device. If this confirms your suspicions, find out from the list in this section on which board the device is located, and carefully remove the board from its holder (first removing circuit

board retaining rail — two wood screws). Push it firmly home once or twice, which may clear the fault if the trouble was a dirty contact. If the trouble still persists you will have to obtain expert attention for the board.

If the studio overheats or smells or burning, or breaks down altogether, the fault will either be in the power pack or in one of the heat dissipating components. The power pack is located near the joystick, and the power components (regulators, speaker amplifiers and reverberation driver) are all on Board A.

Remove the back panel and check Board A for components obviously overheating (slight warmth is normal with some components). If there is no trouble on Board A check the supply rails for +12 and -9 volts, and the small wire shown on the diagram for Board A and marked 11.3 volts (power amplifier supply). Failure of the positive rail will in any case show immediately on the front panel if the Meter deviates from a central reading when switched to Control Voltages. Another possible source of trouble is the breakdown of a large value electrolytic capacitor, but this is rare, particularly if the studio is used regularly.

The foregoing should enable a fault to be located and described, and circuit diagrams are supplied with this Manual. But in any case of genuine breakdown the user is recommended to seek professional advice.

---

# VII — Specimen Patches

On the following pages you will find a number of completed VCS3 Dope Sheets, and more of these are provided for your own use. Further supplies of Dope Sheets can be ordered from us, and we think you will find them very useful.

The purpose of these sheets is self-evident, but you will find individual ways of using them. A single sheet can be filled in with all the information you need to file a patch and control setting for future use. A series of sheets can make up a live performance 'score', and this is why we give places for Start Time and End Time (e.g. 25" and 1'10") and for noting control changes during that time. Pin changes can be shown by follow dots and arrows, or different colours, and the times of pin changes noted beside them. Many other ideas will occur to you as you become more confident in using the studio.

We do not claim any special excellence for the following patches — in fact they had to be designed so that control settings were not too critical to allow for individual variations, and they all use only the resources internally available. But they do give a number of useful demonstrations of most of the phenomena we have discussed in previous Sections. Try to unravel the patches and find out what is happening.

Some of the sheets are marked 'Universal Patch' and these have a secondary object in testing the operation of the studio, because they exercise every device at once. The more spectacular sounds will be shown to their best effect if the VCS3 is connected to power amplifiers and large loudspeakers.

The aim of this Manual is not to lay down fixed rules for using the VCS3, but to give you enough working ability with the studio to achieve your own results in your own way. The possibilities are very large, and can be enlarged still further by using our special keyboards, a second VCS3, and other ancillary equipment.

The final Section (VIII), after the Specimen Patches, is a short Glossary of some of the technical terms we have used which may not be familiar to all readers. Although we have tried to write this Manual in an easily comprehensible way, we trust that users will realise that it is not in any sense a textbook of acoustics, electronics or music. The information we have given is solely to make it easy to use the studio, and we urge owners of the VCS3, particularly those those who are new to electronic music, to read reference books dealing more fully with the subjects involved.

PROJECT/NAME/DATE VCS3 USERS MANUAL SECTION VII

PERFORMANCE /RECORDING NOTES

Specimen Noise Patch detailed in Sect.III.

Try the effect of altering the settings given below

SHEET No : \_\_\_\_\_

PATCH No : 1

SETTING No : \_\_\_\_\_

START TIME: \_\_\_\_\_

END TIME : \_\_\_\_\_

PERIPHERALS

NONE

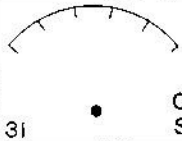
OSC 1				RM'	FILTER/OSC		
0			6		7	5	6
1	2	3	4	5	6	7	8
OSC 2				ENVELOPE			
0	0		6	10	6	6	4
9	10	11	12	13	14	15	16
OSC 3				REVERB			
3	4		6				10
17	18	19	20	21	22	23	24
NOISE		INPUT		OUT. FILTERS		31	
5	8			5	5		
25	26	27	28	29	30		

NUMBERS ARE DOPE SHEET REFERENCES, NOT PIN BOARD NUMBERS

CONTROL CHANGES

1-8

9-16

17-24

25-31

32-39

36 & 39: Best output settings vary slightly from studio to studio.

SIGNALS						CONTROLS						
METER	OUT AMPS		RING MOD		REVERB	OSC. FREQ			REVERB	FILTER	OUT AMPS	
	1	2	A	B		1	2	3			1	2

OSC 1													1
OSC 2													2
OSC 3													3
NOISE													4
INPUT AMPS	1												5
FILTER													6
TRAPEZ													7
ENV SIG													8
RING MOD													9
REVERB													10
STICK													11
													12
													13
													14
													15
													16

9

32

LEFT LOUD

SOFT RIGHT

34

9

33

6.5

6.5

Irregular clicks using Oscillators only. The long cycle of repetition gives an appearance of randomness.

NONE

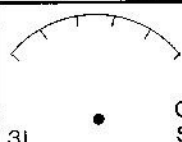
OSC 1				RM	FILTER/OSC			
0.5	9	9	7					
1	2	3	4	5	6	7	8	
OSC 2				ENVELOPE				
1	4	6	7					
9	10	11	12	13	14	15	16	
OSC 3				REVERB				
4.5	4	6	6					
17	18	19	20	21	22	23	24	
NOISE		INPUT		OUT. FILTERS				
				5	5			
25	26	27	28	29	30	31		

CONTROL CHANGES

1-8
9-16
17-24
25-31
32-39

NUMBERS ARE DOPE SHEET REFERENCES, NOT PIN BOARD NUMBERS

SIGNALS						CONTROLS					
METER	OUT AMPS	ENVELOPE	RING MOD	REVERB	FILTER	OSC. FREQ	DECAY	REVERB	FILTER	OUT AMPS	
	1 2	A B				1 2 3				1 2	

OSC 1	~											1				
OSC 2	~											2				
OSC 3	~											3				
NOISE												4				
INPUT AMPS 1												5				
INPUT AMPS 2												6				
FILTER												7				
TRAPEZ												8				
ENV SIG												9				
RING MOD												10				
REVERB												11				
STICK												12				
												13				
												14				
												15				
												16				
	A	B	C	D	E	F	G	H	I	J	K	L	M	N	O	P

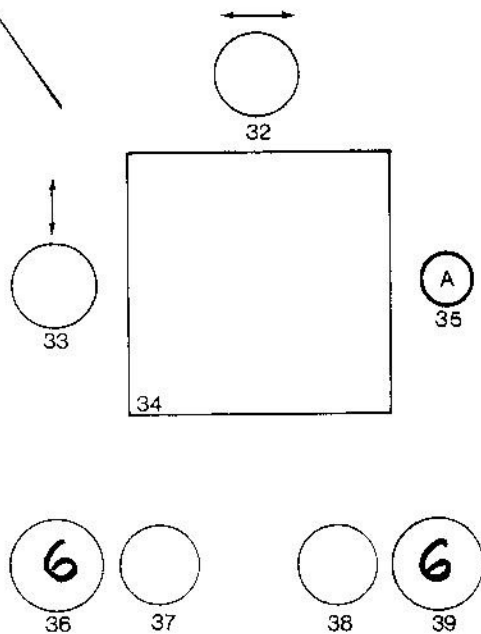



PROJECT/NAME/DATE VCS3 USERS MANUAL SECTION VII	SHEET No :
PERFORMANCE / RECORDING NOTES	PATCH No : 3
Unmodulated mixture on left, modulation products on right, self-switched	SETTING No :
	START TIME :
	END TIME :
Notes: Control 2 - Tune for Symmetry	PERIPHERALS
Controls 3 & 8 - Meter check, using pin positions marked with 'X' one at a time, after which remove pin.	NONE
N.B. Some variation must be expected between different machines.	

OSC 1 5 4-6 ca 6.5 0 1 2 3 4	RM 10 4 8 ca 7 5 6 7 8
OSC 2 1 0 0 2 9 10 11 12	ENVELOPE 10 10 6 4 13 14 15 16
OSC 3 2 10 0 7 17 18 19 20	REVERB 3 10 23 24
NOISE 25 26	INPUT 27 28
OUT. FILTERS 5 5 29 30	31

NUMBERS ARE DOPE SHEET REFERENCES, NOT PIN BOARD NUMBERS

CONTROL CHANGES

1-8
9-16
17-24
25-31
32-39

SIGNALS				CONTROLS						
METER	OUT AMPS	ENVELOPE	RING MOD	REVERB	FILTER	OSC. FREQ	DECAY	REVERB	FILTER	OUT AMPS
	1 2		A B			1 2 3	Y			1 2

OSC 1		X		•	•						1
OSC 2										•	2
OSC 3										•	3
NOISE											4
INPUT AMPS 1											5
INPUT AMPS 2											6
FILTER	X			•	•						7
TRAPEZ										•	8
ENV SIG		•									9
RING MOD			•								10
REVERB											11
STICK							•				12
											13
											14
											15
											16

4-5

32

6

33

ANY

34

5

5

PERFORMANCE / RECORDING NOTES

PATCH No : 4

"Bowing" the Ring Modulator

SETTING No :

START TIME :

END TIME :

Note: Controls 1 & 9 - Tune for concord such as sixth.

PERIPHERALS

NONE

<p>OSC 1</p> <div style="display: flex; justify-content: space-around;"> <span><span style="border: 1px solid black; border-radius: 50%; padding: 5px;">6.2</span></span> <span><span style="border: 1px solid black; border-radius: 50%; padding: 5px;">5.5</span></span> <span><span style="border: 1px solid black; border-radius: 50%; padding: 5px;">6.5</span></span> <span><span style="border: 1px solid black; border-radius: 50%; padding: 5px;"></span></span> </div> <div style="display: flex; justify-content: space-around; margin-top: 5px;"> <span>1</span><span>2</span><span>3</span><span>4</span> </div>	<p>RM FILTER/OSC</p> <div style="display: flex; justify-content: space-around;"> <span><span style="border: 1px solid black; border-radius: 50%; padding: 5px;">9</span></span> <span><span style="border: 1px solid black; border-radius: 50%; padding: 5px;">6</span></span> <span><span style="border: 1px solid black; border-radius: 50%; padding: 5px;">3</span></span> <span><span style="border: 1px solid black; border-radius: 50%; padding: 5px;">8</span></span> </div> <div style="display: flex; justify-content: space-around; margin-top: 5px;"> <span>5</span><span>6</span><span>7</span><span>8</span> </div>
<p>OSC 2</p> <div style="display: flex; justify-content: space-around;"> <span><span style="border: 1px solid black; border-radius: 50%; padding: 5px;">6.8</span></span> <span><span style="border: 1px solid black; border-radius: 50%; padding: 5px;">0</span></span> <span><span style="border: 1px solid black; border-radius: 50%; padding: 5px;"></span></span> <span><span style="border: 1px solid black; border-radius: 50%; padding: 5px;">2.5</span></span> </div> <div style="display: flex; justify-content: space-around; margin-top: 5px;"> <span>9</span><span>10</span><span>11</span><span>12</span> </div>	<p>ENVELOPE</p> <div style="display: flex; justify-content: space-around;"> <span><span style="border: 1px solid black; border-radius: 50%; padding: 5px;">6.5</span></span> <span><span style="border: 1px solid black; border-radius: 50%; padding: 5px;">1.5</span></span> <span><span style="border: 1px solid black; border-radius: 50%; padding: 5px;">6</span></span> <span><span style="border: 1px solid black; border-radius: 50%; padding: 5px;">4</span></span> </div> <div style="display: flex; justify-content: space-around; margin-top: 5px;"> <span>13</span><span>14</span><span>15</span><span>16</span> </div>
<p>OSC 3</p> <div style="display: flex; justify-content: space-around;"> <span><span style="border: 1px solid black; border-radius: 50%; padding: 5px;">3</span></span> <span><span style="border: 1px solid black; border-radius: 50%; padding: 5px;">10</span></span> <span><span style="border: 1px solid black; border-radius: 50%; padding: 5px;"></span></span> <span><span style="border: 1px solid black; border-radius: 50%; padding: 5px;">5</span></span> </div> <div style="display: flex; justify-content: space-around; margin-top: 5px;"> <span>17</span><span>18</span><span>19</span><span>20</span> </div>	<p>REVERB</p> <div style="display: flex; justify-content: space-around;"> <span><span style="border: 1px solid black; border-radius: 50%; padding: 5px;">6.5</span></span> <span><span style="border: 1px solid black; border-radius: 50%; padding: 5px;">10</span></span> <span><span style="border: 1px solid black; border-radius: 50%; padding: 5px;">5</span></span> <span><span style="border: 1px solid black; border-radius: 50%; padding: 5px;">10</span></span> </div> <div style="display: flex; justify-content: space-around; margin-top: 5px;"> <span>21</span><span>22</span><span>23</span><span>24</span> </div>
<p>NOISE INPUT</p> <div style="display: flex; justify-content: space-around;"> <span><span style="border: 1px solid black; border-radius: 50%; padding: 5px;"></span></span> <span><span style="border: 1px solid black; border-radius: 50%; padding: 5px;"></span></span> <span><span style="border: 1px solid black; border-radius: 50%; padding: 5px;"></span></span> <span><span style="border: 1px solid black; border-radius: 50%; padding: 5px;"></span></span> </div> <div style="display: flex; justify-content: space-around; margin-top: 5px;"> <span>25</span><span>26</span><span>27</span><span>28</span> </div>	<p>OUT. FILTERS</p> <div style="display: flex; justify-content: space-around;"> <span><span style="border: 1px solid black; border-radius: 50%; padding: 5px;">5</span></span> <span><span style="border: 1px solid black; border-radius: 50%; padding: 5px;">5</span></span> </div> <div style="display: flex; justify-content: space-around; margin-top: 5px;"> <span>29</span><span>30</span> </div> <div style="text-align: right; margin-top: 5px;"> <span>31</span><span style="font-size: 2em;">.</span><span style="font-size: 2em;">C</span> S                     </div>

CONTROL CHANGES

1-8
9-16
17-24
25-31
32-39

NUMBERS ARE DOPE SHEET REFERENCES, NOT PIN BOARD NUMBERS

		SIGNALS					CONTROLS										
		MULTIPLR	OUT AMPS	ENVEL	RING MOD	REVERB	FILTER	OSC. FREQ	DEMO AY	REVERB	FILTER	OUT AMPS					
		1	2	A	B	1	2	3				1	2				
OSC 1				•										1	2		
OSC 2				•										3	4		
OSC 3									•				•	5	6		
NOISE														7			
INPUT AMPS	1													8	9		
INPUT AMPS	2													8	9		
FILTER				•			•							10			
TRAPEZ					•						•			11			
ENV SIG			•											12			
RING MOD							•							13			
REVERB		•												14			
STICK									•	•				15	16		
		A	B	C	D	E	F	G	H	I	J	K	L	M	N	O	P

6  
32

6  
33

A  
35

5  
36

37

38

6  
39

PROJECT/NAME/DATE VCS3 USERS MANUAL SECTION VII	SHEET No : <span style="border: 1px solid black; display: inline-block; width: 50px; height: 15px;"></span>
PERFORMANCE /RECORDING NOTES	PATCH No : 5
	SETTING No : <span style="border: 1px solid black; display: inline-block; width: 50px; height: 15px;"></span>
"Bounce" effect from Envelope Shaper	START TIME: <span style="border: 1px solid black; display: inline-block; width: 50px; height: 15px;"></span>
	END TIME : <span style="border: 1px solid black; display: inline-block; width: 50px; height: 15px;"></span>
	PERIPHERALS
	NONE

OSC 1	RM	FILTER/OSC
<div style="display: flex; justify-content: space-around;"> <div style="border: 1px solid black; border-radius: 50%; width: 40px; height: 40px; display: flex; align-items: center; justify-content: center;">5</div> <div style="border: 1px solid black; border-radius: 50%; width: 40px; height: 40px; display: flex; align-items: center; justify-content: center;">5</div> <div style="border: 1px solid black; border-radius: 50%; width: 40px; height: 40px; display: flex; align-items: center; justify-content: center;">5</div> <div style="border: 1px solid black; border-radius: 50%; width: 40px; height: 40px; display: flex; align-items: center; justify-content: center;">5</div> </div> <div style="display: flex; justify-content: space-around; margin-top: 5px;"> <span>1</span><span>2</span><span>3</span><span>4</span> </div>	<div style="border: 1px solid black; border-radius: 50%; width: 40px; height: 40px; display: flex; align-items: center; justify-content: center;"> </div> <div style="display: flex; justify-content: space-around; margin-top: 5px;"> <span>5</span> </div>	<div style="display: flex; justify-content: space-around;"> <div style="border: 1px solid black; border-radius: 50%; width: 40px; height: 40px; display: flex; align-items: center; justify-content: center;">7</div> <div style="border: 1px solid black; border-radius: 50%; width: 40px; height: 40px; display: flex; align-items: center; justify-content: center;">2</div> <div style="border: 1px solid black; border-radius: 50%; width: 40px; height: 40px; display: flex; align-items: center; justify-content: center;">10</div> </div> <div style="display: flex; justify-content: space-around; margin-top: 5px;"> <span>6</span><span>7</span><span>8</span> </div>
OSC 2	ENVELOPE	
<div style="display: flex; justify-content: space-around;"> <div style="border: 1px solid black; border-radius: 50%; width: 40px; height: 40px; display: flex; align-items: center; justify-content: center;">5</div> <div style="border: 1px solid black; border-radius: 50%; width: 40px; height: 40px; display: flex; align-items: center; justify-content: center;">5</div> <div style="border: 1px solid black; border-radius: 50%; width: 40px; height: 40px; display: flex; align-items: center; justify-content: center;">5</div> <div style="border: 1px solid black; border-radius: 50%; width: 40px; height: 40px; display: flex; align-items: center; justify-content: center;">5</div> </div> <div style="display: flex; justify-content: space-around; margin-top: 5px;"> <span>9</span><span>10</span><span>11</span><span>12</span> </div>	<div style="display: flex; justify-content: space-around;"> <div style="border: 1px solid black; border-radius: 50%; width: 40px; height: 40px; display: flex; align-items: center; justify-content: center;">0</div> <div style="border: 1px solid black; border-radius: 50%; width: 40px; height: 40px; display: flex; align-items: center; justify-content: center;">0</div> <div style="border: 1px solid black; border-radius: 50%; width: 40px; height: 40px; display: flex; align-items: center; justify-content: center;">4</div> <div style="border: 1px solid black; border-radius: 50%; width: 40px; height: 40px; display: flex; align-items: center; justify-content: center;">2</div> </div> <div style="display: flex; justify-content: space-around; margin-top: 5px;"> <span>13</span><span>14</span><span>15</span><span>16</span> </div>	
OSC 3	REVERB	
<div style="display: flex; justify-content: space-around;"> <div style="border: 1px solid black; border-radius: 50%; width: 40px; height: 40px; display: flex; align-items: center; justify-content: center;">3</div> <div style="border: 1px solid black; border-radius: 50%; width: 40px; height: 40px; display: flex; align-items: center; justify-content: center;">10</div> <div style="border: 1px solid black; border-radius: 50%; width: 40px; height: 40px; display: flex; align-items: center; justify-content: center;"> </div> <div style="border: 1px solid black; border-radius: 50%; width: 40px; height: 40px; display: flex; align-items: center; justify-content: center;">8</div> </div> <div style="display: flex; justify-content: space-around; margin-top: 5px;"> <span>17</span><span>18</span><span>19</span><span>20</span> </div>	<div style="display: flex; justify-content: space-around;"> <div style="border: 1px solid black; border-radius: 50%; width: 40px; height: 40px; display: flex; align-items: center; justify-content: center;">5-7</div> <div style="border: 1px solid black; border-radius: 50%; width: 40px; height: 40px; display: flex; align-items: center; justify-content: center;">10</div> <div style="border: 1px solid black; border-radius: 50%; width: 40px; height: 40px; display: flex; align-items: center; justify-content: center;">2</div> <div style="border: 1px solid black; border-radius: 50%; width: 40px; height: 40px; display: flex; align-items: center; justify-content: center;">8</div> </div> <div style="display: flex; justify-content: space-around; margin-top: 5px;"> <span>21</span><span>22</span><span>23</span><span>24</span> </div>	
NOISE	INPUT	OUT. FILTERS
<div style="display: flex; justify-content: space-around;"> <div style="border: 1px solid black; border-radius: 50%; width: 40px; height: 40px; display: flex; align-items: center; justify-content: center;"> </div> <div style="border: 1px solid black; border-radius: 50%; width: 40px; height: 40px; display: flex; align-items: center; justify-content: center;"> </div> </div> <div style="display: flex; justify-content: space-around; margin-top: 5px;"> <span>25</span><span>26</span> </div>	<div style="display: flex; justify-content: space-around;"> <div style="border: 1px solid black; border-radius: 50%; width: 40px; height: 40px; display: flex; align-items: center; justify-content: center;"> </div> <div style="border: 1px solid black; border-radius: 50%; width: 40px; height: 40px; display: flex; align-items: center; justify-content: center;"> </div> </div> <div style="display: flex; justify-content: space-around; margin-top: 5px;"> <span>27</span><span>28</span> </div>	<div style="display: flex; justify-content: space-around;"> <div style="border: 1px solid black; border-radius: 50%; width: 40px; height: 40px; display: flex; align-items: center; justify-content: center;">5</div> <div style="border: 1px solid black; border-radius: 50%; width: 40px; height: 40px; display: flex; align-items: center; justify-content: center;">5</div> </div> <div style="display: flex; justify-content: space-around; margin-top: 5px;"> <span>29</span><span>30</span> </div>
		<div style="text-align: right;">  31         </div>

NUMBERS ARE DOPE SHEET REFERENCES, NOT PIN BOARD NUMBERS

CONTROL CHANGES	1-8
	9-16
	17-24 21: Best reverberation setting will vary with different VCS3s
	25-31
	32-39

SIGNALS						CONTROLS									
MULTIPLIER	OUT AMPS		ENVELOPE		RING MOD	REVERB	FILTER	OSC. FREQ			DECAY	REVERB	FILTER	OUT AMPS	
	1	2	A	B	A	B		1	2	3		A	B	1	2

	MULTIPLIER	OUT AMPS 1	OUT AMPS 2	ENVELOPE A	ENVELOPE B	RING MOD A	RING MOD B	REVERB	FILTER	OSC. FREQ 1	OSC. FREQ 2	OSC. FREQ 3	DECAY	REVERB	FILTER	OUT AMPS 1	OUT AMPS 2
OSC 1	2			•													
OSC 2	2			•													
OSC 3	2			•						•	•		•				
NOISE																	
INPUT AMPS	1																
INPUT AMPS	2																
FILTER		•						•									
TRAPEZ										•	•				•		
ENV SIG									•								
RING MOD																	
REVERB								•									
STICK																	

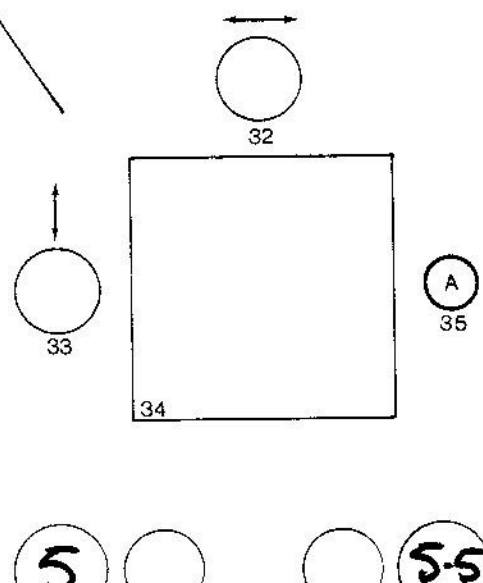

Explosive noises of various different kinds, depending on settings of Joystick and Control No.18

Amplifiers and large loudspeakers if possible.

OSC 1 0 4 0 7 1 2 3 4	RM 5	FILTER / OSC 10 4 10 6 7 8
OSC 2 0 4 0 9 9 10 11 12	ENVELOPE 0 0 7 1 13 14 15 16	
OSC 3 2.5 * 0 10 17 18 19 20	REVERB 7 10 0 10 21 22 23 24	
NOISE 5 10 25 26	INPUT 27 28	OUT. FILTERS 5 5 29 30
		31

NUMBERS ARE DOPE SHEET REFERENCES, NOT PIN BOARD NUMBERS

CONTROL CHANGES

1-8

9-16

17-24 \* Vary control 18 (lowest sounds about 4)

25-31

32-39

SIGNALS CONTROLS

	METER		OUT AMPS		ENVELOPE		RING MOD		REVERB		FILTER		OSC. FREQ.			DECAY		REVERB		FILTER		OUT AMPS	
	1	2	1	2	A	B	A	B	1	2	1	2	1	2	3	1	2	1	2	1	2		
OSC 1																							
OSC 2																							
OSC 3																							
NOISE																							
INPUT AMPS																							
FILTER																							
TRAPEZ																							
ENV SIG																							
RING MOD																							
REVERB																							
STICK																							

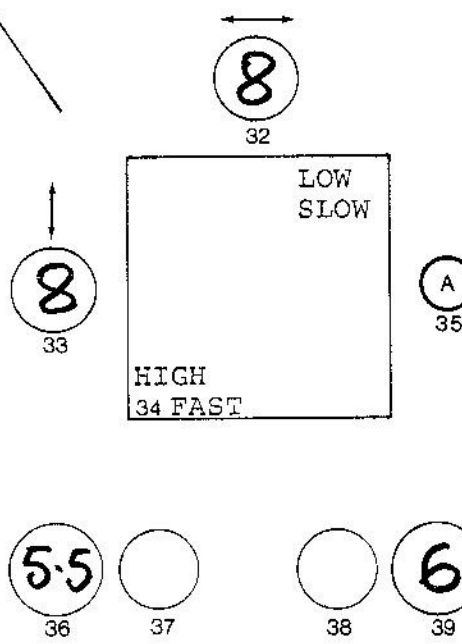

PROJECT/NAME/DATE	VCS3 USERS MANUAL SECTION VII
PERFORMANCE /RECORDING NOTES	Timbre changes through Filter and Ring Modulator
Note: Tune Controls 1 & 9 for best unison over joystick (vertical) range.	



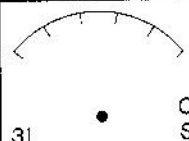

SHEET No :	
PATCH No :	7
SETTING No :	
START TIME:	
END TIME :	
PERIPHERALS	NONE

OSC 1 4.5 5 5 6.5 1 2 3 4	RM 10 5	FILTER/OSC 6 5 10 6 7 8
OSC 2 4.5 5 5 6.5 9 10 11 12	ENVELOPE 5 5 7 4 13 14 15 16	
OSC 3 0.5 5 3 6 17 18 19 20	REVERB 6 8 6 8 21 22 23 24	
NOISE 25 26	INPUT 27 28	OUT. FILTERS 5 5 29 30
31  C S		

NUMBERS ARE DOPE SHEET REFERENCES, NOT PIN BOARD NUMBERS

CONTROL CHANGES
1-8
9-16
17-24
25-31
32-39

SIGNALS						CONTROLS					
METER	OUT AMPS	ENVELOPE	RING MOD	REVERB	FILTER	OSC. FREQ	DECAY	REVERB	FILTER	OUT AMPS	
	1 2		A B			1 2 3				1 2	

OSC 1											1
OSC 2											2
OSC 3											3
NOISE											4
INPUT 1											5
AMPS 2											6
FILTER											7
TRAPEZ											8
ENV SIG											9
RING MOD											10
REVERB											11
STICK											12
											13
											14
											15
											16

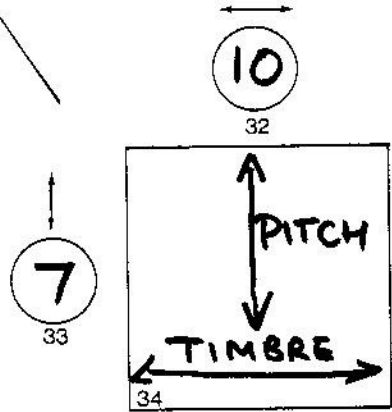

PROJECT/NAME/DATE VCS3 USERS MANUAL SECTION VII	SHEET No :	
PERFORMANCE /RECORDING NOTES UNIVERSAL PATCH	PATCH No :	8
	SETTING No :	
Modulated scales and arpeggios with noise modulation of Filter/Osc.	START TIME :	
	END TIME :	
	PERIPHERALS	
		NONE

OSC 1 6 4 6 6 1 2 3 4	RM 7.5 5	FILTER/OSC 4 8 7 6 7 8
OSC 2 1.5 1 5 2 9 10 11 12	ENVELOPE 6 6 10 5 13 14 15 16	
OSC 3 3 9 4 7 17 18 19 20	REVERB 5-7 10 6 10 21 22 23 24	
NOISE 9 6 25 26	INPUT 27 28	OUT. FILTERS 7 2 29 30
		31

NUMBERS ARE DOPE SHEET REFERENCES, NOT PIN BOARD NUMBERS

CONTROL CHANGES
1-8
9-16
17-24 21: Adjust for best pos.
25-31
32-39 35: Press to raise pitch and stimulate LH.

	SIGNALS				CONTROLS												
	M	OUT	E	R	OSC.	D	R	F	OUT								
	1	2	A	B	FREQ	1	2	3	DECAY	REVERB	F	1	2				
OSC 1																	1
OSC 2																	2
OSC 3																	3
NOISE																	4
INPUT AMPS	1																5
FILTER																	6
TRAPEZ																	7
ENV SIG																	8
RING MOD																	9
REVERB																	10
STICK																	11
																	12
																	13
																	14
																	15
																	16
	A	B	C	D	E	F	G	H	I	J	K	L	M	N	O	P	

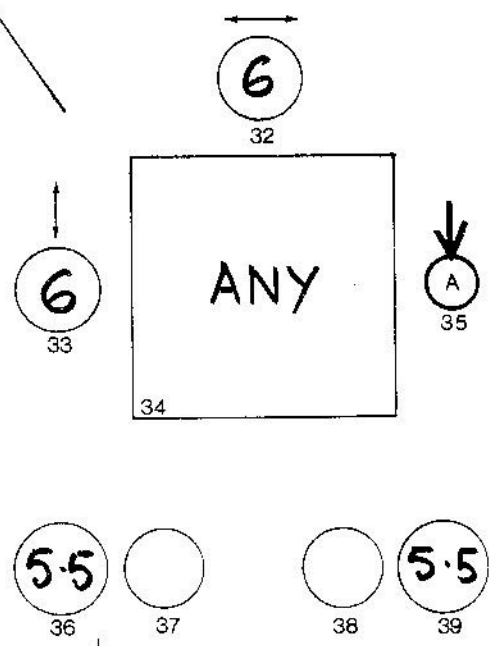

PROJECT/NAME/DATE VCS3 USERS MANUAL SECTION VII	SHEET No :
PERFORMANCE/RECORDING NOTES UNIVERSAL PATCH	PATCH No : 9
	SETTING No :
Random frequency modulation by filtered noise, and reverberated ring modulated sounds	START TIME :
	END TIME :
	PERIPHERALS
	NONE
Note: In some cases Filter will oscillate at lowest point of range. Set for lowest frequency which does not oscillate.	

OSC 1 6 4 7 4 1 2 3 4	RM 8 1.5 5 6	FILTER/OSC 6 10 7 8
OSC 2 5 5 35 55 9 10 11 12	ENVELOPE 0 10 10 10 13 14 15 16	
OSC 3 35 4 3 10 17 18 19 20	REVERB 5 7 6 10 21 22 23 24	
NOISE 1 10 25 26	INPUT 27 28	OUT. FILTERS 5 0 29 30

NUMBERS ARE DOPE SHEET REFERENCES, NOT PIN BOARD NUMBERS

CONTROL CHANGES
1-8 7: Check that Filter does not oscillate
9-16
17-24
25-31
32-39 35: Attack to activate left hand side

SIGNALS CONTROLS

METER	OUT AMPS	ENVELOPE	RING MOD	REVERB	FILTER	OSC. FREQ	DECAY	REVERB	FILTER	OUT AMPS
	1 2	A B				1 2 3	A Y	B		1 2

OSC 1											1					
OSC 2											2					
OSC 3											3					
NOISE											4					
INPUT AMPS 1											5					
INPUT AMPS 2											6					
FILTER											7					
TRAPEZ											8					
ENV SIG											9					
RING MOD											10					
REVERB											11					
STICK											12					
											13					
											14					
											15					
											16					
	A	B	C	D	E	F	G	H	I	J	K	L	M	N	O	P

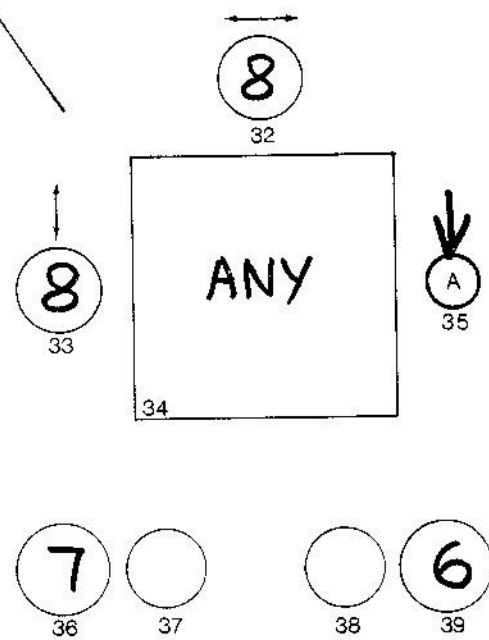

PROJECT/NAME/DATE VCS3 USERS MANUAL SECTION VII	SHEET No :
PERFORMANCE/RECORDING NOTES	PATCH No : 10
Three part chords automatically changing, with further variations by moving pins.	SETTING No :
	START TIME :
	END TIME :
	PERIPHERALS
Note: Conts 1,6 & 9 can be tuned to produce different chord sequences.	
	NONE

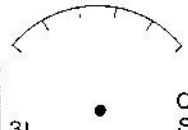
OSC 1 5.5 4 8 8 1 2 3 4	RM 5	FILTER/OSC 4 8 10 6 7 8
OSC 2 6 4 3 3.5 9 10 11 12	ENVELOPE 0 10 2 5.5 13 14 15 16	
OSC 3 3.5 4 5 0 17 18 19 20	REVERB 5-7 10 4 5.5 21 22 23 24	
NOISE 25 26	INPUT 27 28	OUT. FILTERS 6 3 29 30
		31  CS

NUMBERS ARE DOPE SHEET REFERENCES, NOT PIN BOARD NUMBERS

CONTROL CHANGES
1-8
9-16 16: Should be set at max. point for self-triggering.
17-24 21: Set at best position.
25-31
32-39

	SIGNALS				CONTROLS												
	METER	OUT AMPS	ENVELOPE	RING MOD	REVERB	FILTER	OSC. FREQ	DELAY	REVERB	FILTER	OUT AMPS						
	1	2	A	B	B	R	1	2	3	A	B	1	2				
OSC 1		•	•													1	
OSC 2		•	•													2	
OSC 3		•	•													3	
NOISE																4	
INPUT AMPS	1															5	
FILTER		•	•													6	
TRAPEZ																7	
ENV SIG																8	
RING MOD																9	
REVERB			•													10	
STICK																11	
																12	
																13	
																14	
																15	
																16	
	A	B	C	D	E	F	G	H	I	J	K	L	M	N	O	P	

Change arrangement of these pins to obtain different patterns

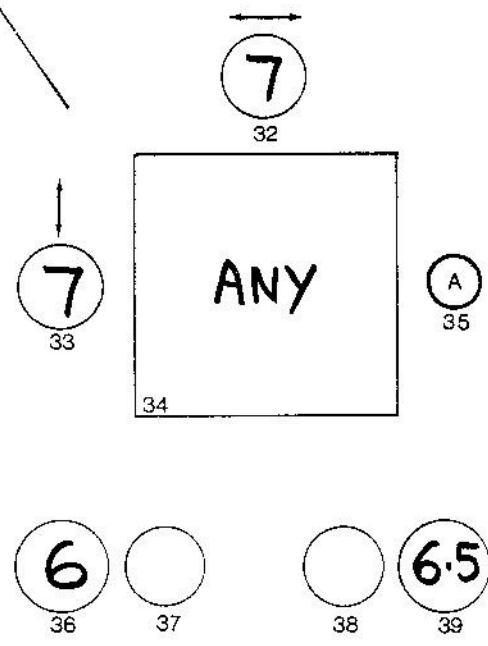

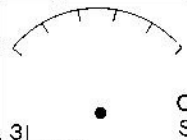

PROJECT/NAME/DATE VCS3 USERS MANUAL SECTION VII	SHEET No :
PERFORMANCE/RECORDING NOTES UNIVERSAL PATCH	PATCH No : 11
	SETTING No :
Pizzicato-like scales and arpeggios on right, steam-like noises on left	START TIME:
	END TIME :
	PERIPHERALS
Note: Joystick alternatives can be used simultaneously if you have more than 20 pins	NONE

OSC 1 6.5 4 7 2 1 2 3 4	RM 9 7.5 5 10 5 6 7 8	FILTER/OSC
OSC 2 1.5 4 7 2 9 10 11 12	ENVELOPE 0 10 65 4 13 14 15 16	
OSC 3 4 4.5 7 6 17 18 19 20	REVERB 3.6 10 6 10 21 22 23 24	
NOISE 5 6 25 26	INPUT 27 28	OUT. FILTERS 5 5 29 30
31 		

NUMBERS ARE DOPE SHEET REFERENCES, NOT PIN BOARD NUMBERS

CONTROL CHANGES
1-8
9-16
17-24
21: Adjust for best pos.
25-31
32-39

**SIGNALS      CONTROLS**

	METER	OUT AMPS	ENVELOPE	RING MOD	REVERB	FILTER	OSC. FREQ	DECAY	REVERB	FILTER	OUT AMPS		
	1	2	A	B	B	R	1	2	3	B	R	1	2
OSC 1												1	
OSC 2												2	
OSC 3												3	
NOISE												4	
INPUT 1												5	
AMPS 2												6	
FILTER												7	
TRAPEZ												8	
ENV SIG												9	
RING MOD												10	
REVERB												11	
STICK												12	
												13	
												14	
												15	
												16	

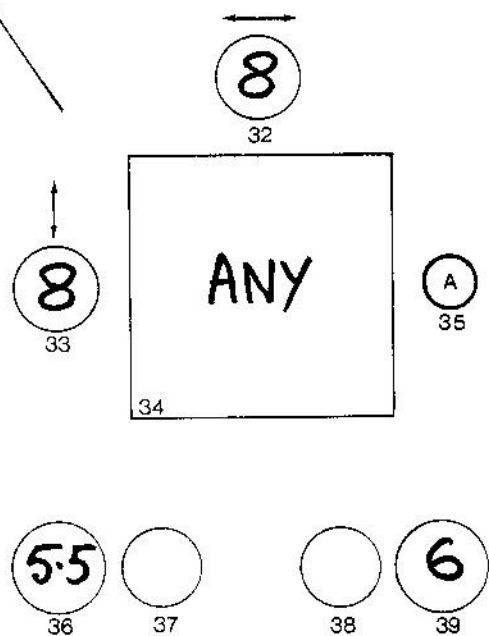

PROJECT/NAME/DATE VCS3 USERS MANUAL SECTION VII	SHEET No :	
PERFORMANCE /RECORDING NOTES	PATCH No :	12
Twittering and chirping with variable pitch and rhythm	SETTING No :	
	START TIME:	
	END TIME :	
PERIPHERALS		
NONE		

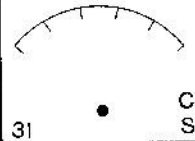
OSC 1 8 4 5 5 1 2 3 4	RM 10 10 3 8 5 6 7 8	FILTER/OSC 10 3 8 6 7 8
OSC 2 10 5 4 5 9 10 11 12	ENVELOPE 0 0 0 2 13 14 15 16	
OSC 3 3 4 7 7 17 18 19 20	REVERB 6 8 4 10 21 22 23 24	
NOISE 25 26	INPUT 27 28	OUT. FILTERS 5 5 29 30
		31  C S

NUMBERS ARE DOPE SHEET REFERENCES, NOT PIN BOARD NUMBERS

CONTROL CHANGES
1-8
9-16
17-24
25-31
32-39

	SIGNALS				CONTROLS														
	OSC 1	OSC 2	OSC 3	NOISE	OUT AMPS 1	OUT AMPS 2	ENVELOPE A	RING MOD B	REVERB	FILTER	OSC. FREQ 1	OSC. FREQ 2	OSC. FREQ 3	DECOY	REVERB	FILTER	OUT AMPS 1	OUT AMPS 2	
OSC 1	~																		
OSC 2	~																		
OSC 3	~																		
NOISE																			
INPUT AMPS 1																			
INPUT AMPS 2																			
FILTER																			
TRAPEZ																			
ENV SIG																			
RING MOD																			
REVERB																			
STICK																			

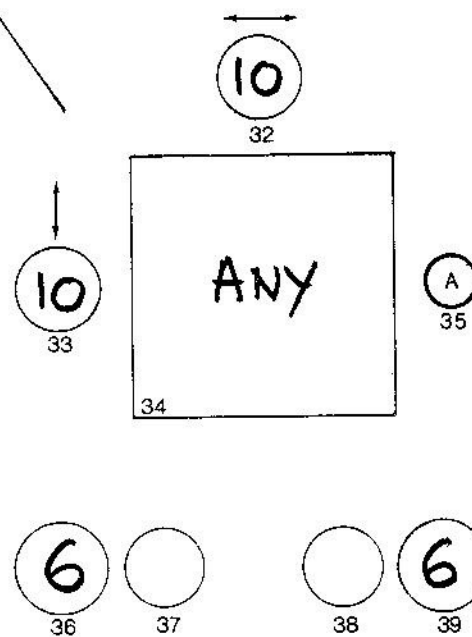

PROJECT/NAME/DATE VCS3 USERS MANUAL SECTION VII	SHEET No :
PERFORMANCE /RECORDING NOTES	PATCH No : 13
<u>SCOPE connected to INPUT 1</u>	SETTING No :
Scales and arpeggios in contrary motion	START TIME :
	END TIME :
<u>Note: Settings may have to be adjusted for the individual VCS3.</u>	PERIPHERALS
	NONE

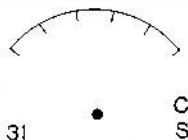
OSC 1 6 5.5 8 2 1 2 3 4	RM 5	FILTER/OSC 5.5 8 6 6 7 8
OSC 2 1.5 10 2 9 10 11 12	ENVELOPE 6 5 6 0 13 14 15 16	
OSC 3 2.5 0 6.5 17 18 19 20	REVERB 5-7 10 10 21 22 23 24	
NOISE 25 26	INPUT 4-6 27 28	OUT. FILTERS 5 5 29 30
		31  C S

NUMBERS ARE DOPE SHEET REFERENCES, NOT PIN BOARD NUMBERS

CONTROL CHANGES
1-8
9-16
17-24 21: Adjust for best pos.
26-31 27: Adjust to give best range on Filter/Osc.
32-39

	SIGNALS				CONTROLS												
	OUT AMPS	ENVELOPE	RING MOD	REVERB	FILTER	OSC. FREQ	DECAY	REVERB	FILTER	OUT AMPS							
	1	2	A	B		1	2	3			1	2					
OSC 1															1		
OSC 2															2		
OSC 3															3		
NOISE															4		
INPUT															5		
AMPS															6		
FILTER															7		
TRAPEZ															8		
ENV SIG															9		
RING MOD															10		
REVERB															11		
STICK															12		
															13		
															14		
															15		
															16		
	A	B	C	D	E	F	G	H	I	J	K	L	M	N	O		

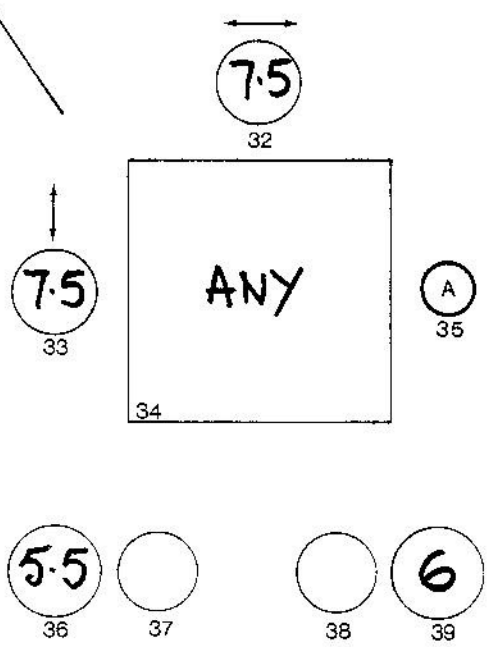

PROJECT/NAME/DATE VCS3 USERS MANUAL SECTION VII	SHEET No :
PERFORMANCE /RECORDING NOTES	PATCH No : 14
<u>SCOPE connected to INPUT 1</u>	SETTING No :
Rhythmic inversion - i.e. when left is fast right is slow	START TIME:
	END TIME :
	PERIPHERALS
<u>Note:</u> Small adjustments may be necessary to Envelope Shaper controls and to Input 1 control	NONE

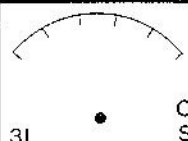
OSC 1				RM	FILTER/OSC			
6.5	4	5	4	8	5	8	6	
1	2	3	4	5	6	7	8	
OSC 2				ENVELOPE				
0.5	4	6		1.5	1.5	1	2	
9	10	11	12	13	14	15	16	
OSC 3				REVERB				
3.5	0	4	6.5	4-6	10	2	10	
17	18	19	20	21	22	23	24	
NOISE		INPUT		OUT. FILTERS				
		8		5	5			
25	26	27	28	29	30	31		

NUMBERS ARE DOPE SHEET REFERENCES, NOT PIN BOARD NUMBERS

CONTROL CHANGES	
1-8	
9-16	
17-24	
25-31	
32-39	

	SIGNALS				CONTROLS											
	OUT AMPS	ENVEL	RING MOD	REVERB	FILTER	OSC. FREQ	DECAY	REVERB	FILTER	OUT AMPS						
	1	2	A	B		1	2	3		1	2					
OSC 1			•								1					
OSC 2				•							2					
OSC 3											3					
NOISE	•										4					
INPUT											5					
AMPS											6					
FILTER			•								7					
TRAPEZ											8					
ENV SIG											9					
RING MOD	•										10					
REVERB		•									11					
STICK											12					
											13					
											14					
											15					
											16					
	A	B	C	D	E	F	G	H	I	J	K	L	M	N	O	P

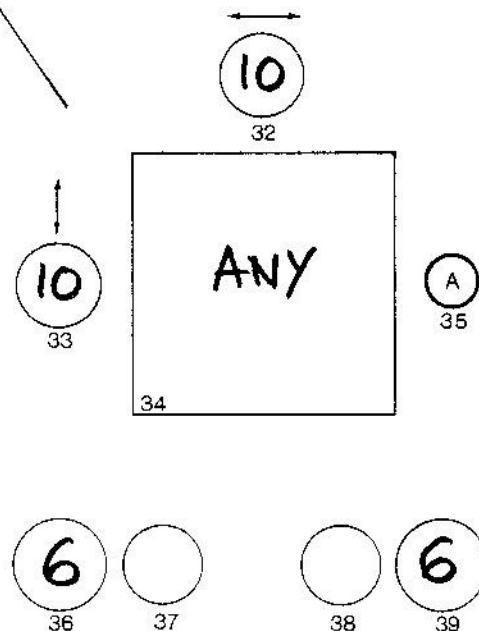

PROJECT/NAME/DATE VCS3 USERS MANUAL SECTION VII	SHEET No :
PERFORMANCE /RECORDING NOTES	PATCH No : 15
SCOPE connected to INPUT 1	SETTING No :
CONTROL OUTPUT 2 connected to INPUT 2	START TIME:
	END TIME :
Two inverted controls, affecting Oscs.1 & 2, and filtered noise	PERIPHERALS
Note: Output 2 is at 0, because this channel is being used for control - i.e. only one audio output is used	NONE

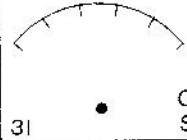
OSC 1 6 4 8 6 1 2 3 4	RM 5	FILTER/OSC 10 5 10 6 7 8
OSC 2 6.5 4 6 6 9 10 11 12	ENVELOPE 10 10 7 2 13 14 15 16	
OSC 3 2 6 8 17 18 19 20	REVERB 5 10 6 21 22 23 24	
NOISE 5 9 25 26	INPUT 10 10 27 28	OUT. FILTERS 5 5 29 30
		31  CS

NUMBERS ARE DOPE SHEET REFERENCES, NOT PIN BOARD NUMBERS

CONTROL CHANGES
1-8
9-16
17-24
25-31
32-39

	SIGNALS				CONTROLS									
	OUT AMPS	ENVELOPE	RING MOD	REVERB	FILTER	OSC. FREQ	DECAY	REVERB	FILTER	OUT AMPS				
	1	2	A	B		1	2	3			1	2		
OSC 1					•									1
OSC 2					•									2
OSC 3					•									3
NOISE	•					•					•			4
INPUT 1							•	•				•		5
INPUT 2							•	•				•		6
FILTER					•									7
TRAPEZ		•						•				•		8
ENV SIG														9
RING MOD														10
REVERB				•										11
STICK														12
														13
														14
														15
														16

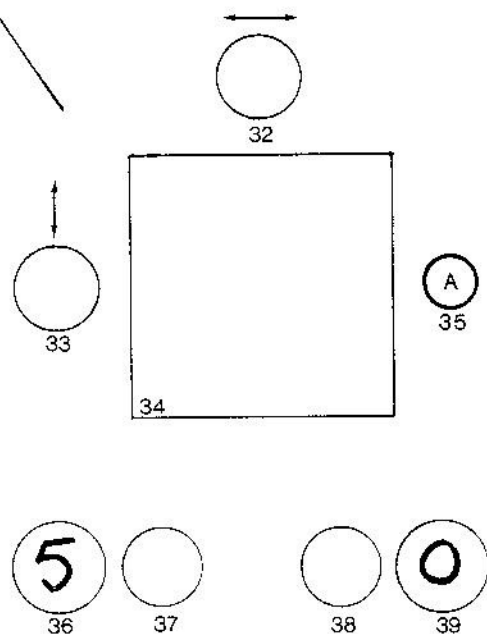

# VIII—Glossary

- AC** Alternating Current. Current whose direction is continually changing, normally at a definite frequency (q.v.).
- Amplitude** The maximum instantaneous value of a current (q.v.) or voltage (q.v.) during a half cycle of alternating current. High amplitude peaks can occur in a generally low level signal.
- Attenuate** Make smaller. The opposite of **amplify**. An attenuator is usually a network of resistors (q.v.).
- Audio** e.g. a-frequency, a-output. Within the audible range. Electrical signals which would be audible if converted into sound. Compare video — the picture signals in TV.
- Bandwidth** The width of a stated range or band of frequencies, described by its lower and upper limits (e.g. a B of 100Hz-800Hz, or of three octaves upwards from 100Hz). May refer to a band which is being rejected from an otherwise flat response (q.v.), or an accepted band (as in the VCS3 Filter).
- Beat** In its audio sense a phenomenon caused by two frequencies so close that the difference tone is observed as a throb or pulse — e.g. 250Hz and 252Hz would produce a beat of 2Hz or one every half second.
- Capacitance** (-tor, -tive) (C). The amount of electrostatic storage available in an insulator (dielectric) separating two closely adjacent conducting surfaces. Measured in Farads (usually microFarads). A Capacitor is a device possessing Capacitance, and is Capacitive (general rule for properties and devices). A frequency sensitive component with many uses. The electrical equivalent of compliance.
- Current** (I). Electrical flow, expressed in Amperes or milliAmperes. A current cannot flow without a potential gradient, or voltage, to impel it. The amount of flow depends on this voltage and on the resistance offered to it (see **Resistance**).
- dB** Decibels, or tenths of Bels. A logarithmic ratio unit, used to express gain or loss of power or voltage, either in a single device or a complete equipment. Double the power = a gain of 3dB.
- DC** Direct Current, or current which always flows in the same direction.
- Differentiation** Degradation of waveform (q.v.) when the time constant (q.v.) of a capacitive (q.v.) circuit is much shorter than the cycle time of the waveform. Causes e.g. sharpening or spiking of a square waveform.
- Earth** see **Ground**.
- Equalisation** (sometimes Compensation). Non-linear circuit to correct the response (q.v.) when a device or signal is also non-linear. A disc, for example, has a progressive bass cut in its recording characteristic, and this must be corrected by a bass-boosting equaliser on playback. There are certain agreed international tape equalising standards. See **Linear**.
- Frequency** The number of times every second that an alternating current or sound repeats itself. The higher the frequency the higher the pitch. Expressed in Hertz (Hz) or Kilohertz (KHz).
- Gain** see **dB**.
- Ground** (in UK often Earth). The neutral return rail of most electronic circuits, used as a reference and regarded as 0 volts. The metal parts of the VCS3, the screens of cables etc., are all connected to Ground, which may or may not be actually connected to the earth via the house wiring system.
- Harmonic** (Sometimes Partial or Overtone). The natural series resulting from any object vibrating at a definite main frequency (the Fundamental). The harmonics occur at 2, 3, 4 etc. times the fundamental frequency. Their presence or absence and their relative amplitudes determine the timbre of a note, and certain waveforms have known harmonic contents, a useful fact for the composer.
- Hz** see **Frequency**
- Impedance** (Z). The total apparent resistance (q.v.) of a circuit at a given frequency. In fact the vector sum of the resistances and reactances (q.v.) in the circuit. Expressed in ohms.
- Inductance** (-tor, -tive) (L). The magnetic effect of a current. Acts oppositely from capacitance (q.v.), and when capacitive and inductive reactance (q.v.) are equal the result is resonance, resonant LC circuits being used in the design of some oscillators and filters. Devices like tape heads depend on inductance for their operation. Expressed in Henrys. The electrical equivalent of mass.
- Level** Sometimes synonymous with amplitude (q.v.), but by no means always. In practical audio terms, higher level means louder. Sometimes used, however, to mean same as *flat*, e.g. a flat response or level response (q.v.) meaning the same at all frequencies.
- Line** (mostly UK in this sense). In an audio system, the main signal output(s) from the mixing system, distributed to amplifiers, tape recorders etc. as required. It is normally at a standard agreed level and at 600 ohms impedance (q.v.).
- Linear** Not curved, having a straight line characteristic, but not necessarily level. A straight sided ramp waveform shows a *linear* increment of voltage. An ideal flat response (q.v.) is linear, but most are non-linear.
- Modulation** One signal modified at the frequency of another, and vice versa, normally in one parameter (q.v.), such as frequency or amplitude, but sometimes more than one. The term is sometimes used to describe controlled panning from one speaker to another (spatial mod), and phase (q.v.) modulation can also occur. A perfect ring modulator is a pure multiplier, the result being the instantaneous product of the two input voltages. When the equation is worked out for two sinusoidal (q.v.) inputs, only two frequencies remain, the sum and the difference of the inputs.
- Ohms** see **Impedance, Reactance, Resistance**
- Oscillator** A circuit which can only ring or resonate at one frequency, with a regenerative amplifier to keep the oscillations continuously going. In a voltage controlled oscillator, the effective resonant frequency of the circuit is altered by applying a voltage to it.
- Parameter** Any characteristic of a device whose alteration will affect the performance of that device. The most relevant parameters of e.g. an oscillator are the frequency, the waveform (q.v.) and the level, but a complete list would include everything else about it, such as circuit details, power supply, physical layout, which must all be known to describe the oscillator exactly.
- p-p** (Peak-to-peak). The voltage found by measuring a waveform (q.v.) vertically from the highest positive peak to the lowest negative peak. Twice the peak voltage, and more than twice the r.m.s. (q.v.) voltage.
- Phase** The time relationship of two alternating currents. Two waveforms that start their cycle simultaneously are *in phase* (but will only remain so if the frequencies are the same). Exactly opposed waveforms are *180 degrees out of phase*, and all lags or leads of one wave over the other are similarly measured as an angular difference.
- Potentiometer** Originally what it says — a device for measuring potential or voltage. Now normally any three-terminal variable resistor — i.e. the two ends of the resistive track plus the wiper which slides along it.
- Reactance** (X) The effective resistive effect of a capacitor (q.v.) or inductor (q.v.). Not in fact the same as resistance, because frequency dependent and phase shifting, but measured in ohms as if it were resistance. See **Impedance**.
- Resis-tance** (-tor, -tive) (R). The electrical equivalent of friction. Expressed in ohms or Kiloohms, but unlike capacitance and inductance not frequency dependent. The relationship between resistance, voltage (q.v.) and current (q.v.) in a circuit is governed by Ohm's Law, which states that I (Current) = V (Voltage)/R (Resistance). This simple formula (in its three forms) can be used to make many deductions from a specification, and Impedance (Z) may be substituted for R in the expression where applicable. Units are Amps, Volts and Ohms, so allowance must be made for e.g. milliAmps or Kiloohms.

**Response** The output level of a device compared with its input at all frequencies. If the output/input ratio remains constant the response is flat or level. A part of the spectrum may be specified, as high frequency response.

**r.m.s.** Root Mean Square. A method of rating an AC voltage to indicate its power capabilities at a given current. 230 VAC r.m.s. will do the same amount of work as 230 VDC, although its actual voltage is almost never 230V (four times per cycle instantaneously). Arrived at by squaring samples of the instantaneous voltage and taking the square root of this. For example, mains at 230 VAC r.m.s. has a peak voltage of 325, or 1.414 x the r.m.s. value. Peak to peak voltage is twice this amount, or 650.

**Sine** (Sinewave, Sinusoidal, Sinus). The shape of a waveform containing one frequency only, or simple harmonic motion in the case of mechanical movement. The graphical representation of the sine of an angle through 360 degrees. The output of an ideal alternator, an ideal oscillator or an ideal tuning fork. Any waveform, however complex, can in theory be reduced to a collection of sinewaves of different frequencies, amplitudes and phase.

**Time Constant** When a capacitance (q.v.) is charged through a resistance (q.v.), the product of their values (CR) gives the time taken for the capacitor to reach 63.2% of its final charge. Important information in many circuits. See **Differentiation**.

**Tolerance** The design limits of a device or circuit. A resistor with 10% tolerance may be as much as 10% higher or lower than its nominal value. The closer the tolerance specified for a component or system, the more costly it usually is.

**Voltage (V)**. Electrical pressure. Before current can flow in a circuit a potential difference must exist, and the current flows in an attempt to equalise this difference. For the relationship between voltage, current and resistance, see **Resistance**.

**Waveform** The shape of an alternating current, usually described as it looks when graphically represented or displayed on an oscilloscope. Thus ramp, square, sinusoidal waveform. Any waveform can be analysed to yield its harmonic (q.v.) content.

EMS (LONDON) SYNTHI 'A' - PATCH No.

NOTES

FILTER / OSC.



R.MOD



REVERB



I/P LEVEL



ENV. SHAPER



RANGE



A B C D E F G H I J K L M N O P

1	●	●	●	●	●	●	●	●	●	●	●	●	●	●	●	●	●
2	●	●	●	●	●	●	●	●	●	●	●	●	●	●	●	●	●
3	●	●	●	●	●	●	●	●	●	●	●	●	●	●	●	●	●
4	●	●	●	●	●	●	●	●	●	●	●	●	●	●	●	●	●
5	●	●	●	●	●	●	●	●	●	●	●	●	●	●	●	●	●
6	●	●	●	●	●	●	●	●	●	●	●	●	●	●	●	●	●
7	●	●	●	●	●	●	●	●	●	●	●	●	●	●	●	●	●
8	●	●	●	●	●	●	●	●	●	●	●	●	●	●	●	●	●
9	●	●	●	●	●	●	●	●	●	●	●	●	●	●	●	●	●
10	●	●	●	●	●	●	●	●	●	●	●	●	●	●	●	●	●
11	●	●	●	●	●	●	●	●	●	●	●	●	●	●	●	●	●
12	●	●	●	●	●	●	●	●	●	●	●	●	●	●	●	●	●
13	●	●	●	●	●	●	●	●	●	●	●	●	●	●	●	●	●
14	●	●	●	●	●	●	●	●	●	●	●	●	●	●	●	●	●
15	●	●	●	●	●	●	●	●	●	●	●	●	●	●	●	●	●
16	●	●	●	●	●	●	●	●	●	●	●	●	●	●	●	●	●

OSC. 1

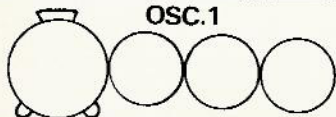

OSC. 2

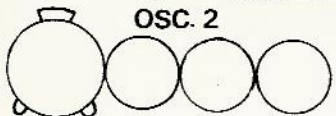

OSC. 3

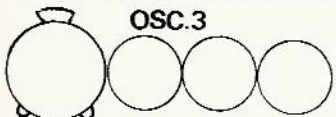

NOISE

O/P FILTER

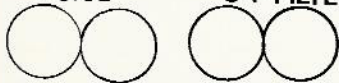

O/P CHANNEL

