

TRANSISTOR IDENTIFICATION

PART NO.	TRANSISTOR
01-1201-0	Q701
01-1205-0P	Q702
01-2101-0	Q201, Q202, Q301, Q521, Q522
01-2104-0	Q804, Q805, Q808, Q901, Q903
01-2106-0	Q904
01-2108-0	Q902, Q906
01-2109-0	Q807
01-2110-0	Q801, Q802, Q809, Q810
01-2114-0	Q806

KEYING

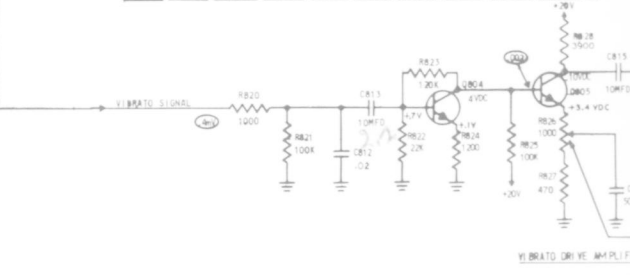
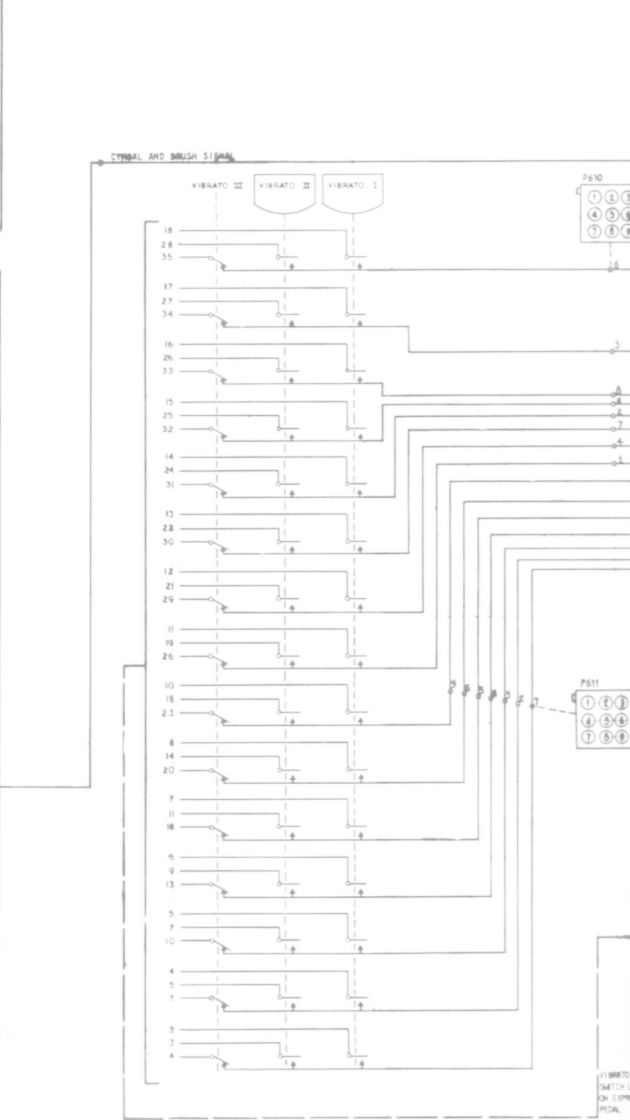
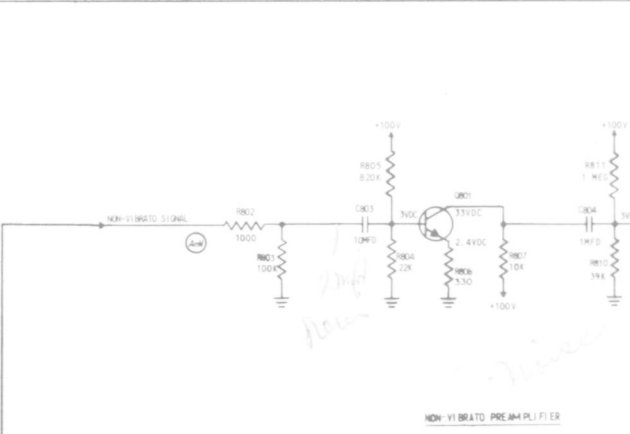
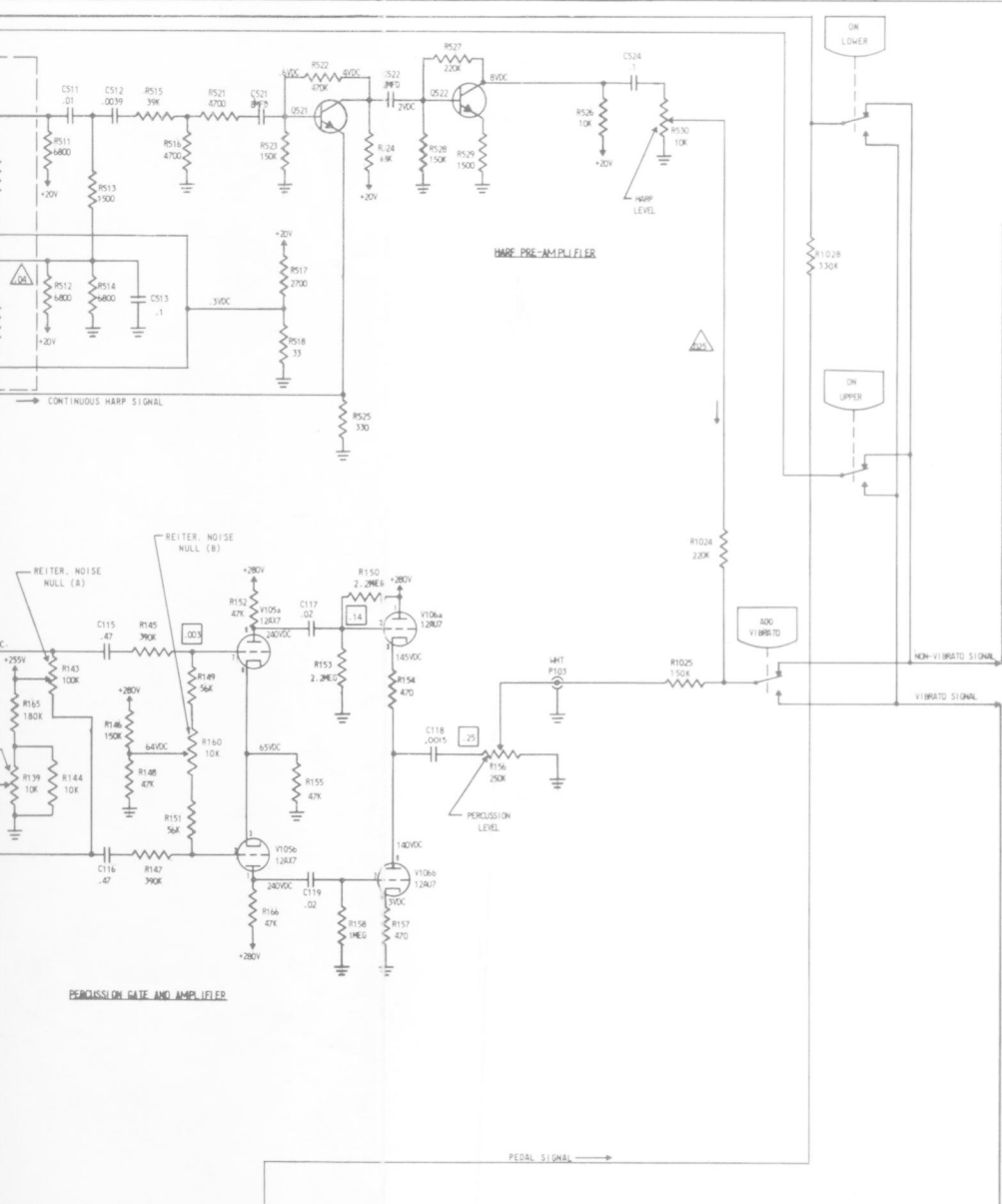

- NOTES:**
1. A.C. VOLTS (RMS) TEST CONDITIONS (MAX. EXPRESSION ALWAYS)
 - — PLAY KEY #25; 2ND. HARM. DRAWBAR AT B; NO VIBRATO.
 - — PLAY KEY #25; 2ND HARM. DRAWBAR AT B; VIBRATO III.
 - — PLAY PEDAL #13; 16 FT. MELLOW DRAWBAR AT B; NO VIBRATO.
 - — PLAY KEY #25; *HARD* AND *SECOND VOICE* ON.
 - — PLAY KEY #13; *HARP SUSTAIN* ON.
 - — PLAY FIRST FIVE KEYS; DRAWBARS 0004070800; FULL REVER.
 2. COMPONENTS NUMBERED 100-199 ARE LOCATED IN THE PERCUSSION & REITERATION DRIVE CHASSIS.
 3. COMPONENTS NUMBERED 200-249 ARE LOCATED IN THE POWER AMPLIFIER CHASSIS.
 4. COMPONENTS NUMBERED 300-499 ARE LOCATED IN THE HARP SUSTAIN ASSEMBLY.
 5. COMPONENTS NUMBERED 500-599 ARE LOCATED ON THE MISCELLANEOUS TERMINALS AND EXPRESSION CONTROL.
 6. COMPONENTS NUMBERED 600-699 ARE LOCATED IN THE POWER SUPPLY CHASSIS.
 7. COMPONENTS NUMBERED 700-799 ARE LOCATED ON THE PREAMPLIFIER BOARDS.
 8. COMPONENTS NUMBERED 800-899 ARE LOCATED ON THE BRUSH & CYMBAL BOARD.
 9. COMPONENTS NUMBERED 900-999 ARE LOCATED ON THE CONTROL SWITCH ASSEMBLY.
 10. COMPONENTS NUMBERED 1000-1099 ARE LOCATED ON THE CONTROL SWITCH ASSEMBLY.
 3. — DENOTES CONTACT #2 OF A CONNECTOR SHOWN NEARBY.
 4. ALL INDICATED D.C. VOLTAGES ARE POSITIVE, MEASURED TO GROUND USING A V.T.V.M.
 5. D.C. VOLTS MARKED ** ARE MEASURED WITH CIRCUIT KEYS ON.
 6. ALL THE CONTACTS OF A PEDAL SWITCH ARE HELD CLOSED BY AN ACTIVATED SOLENOID, EXCEPT THE KEY-NG CONTACT.
 7. R515 MAY BE LEFT OUT OR SELECTED FROM THE VALUES 4.7MEG, 3.3MEG, 2.2MEG AND 1MEG.

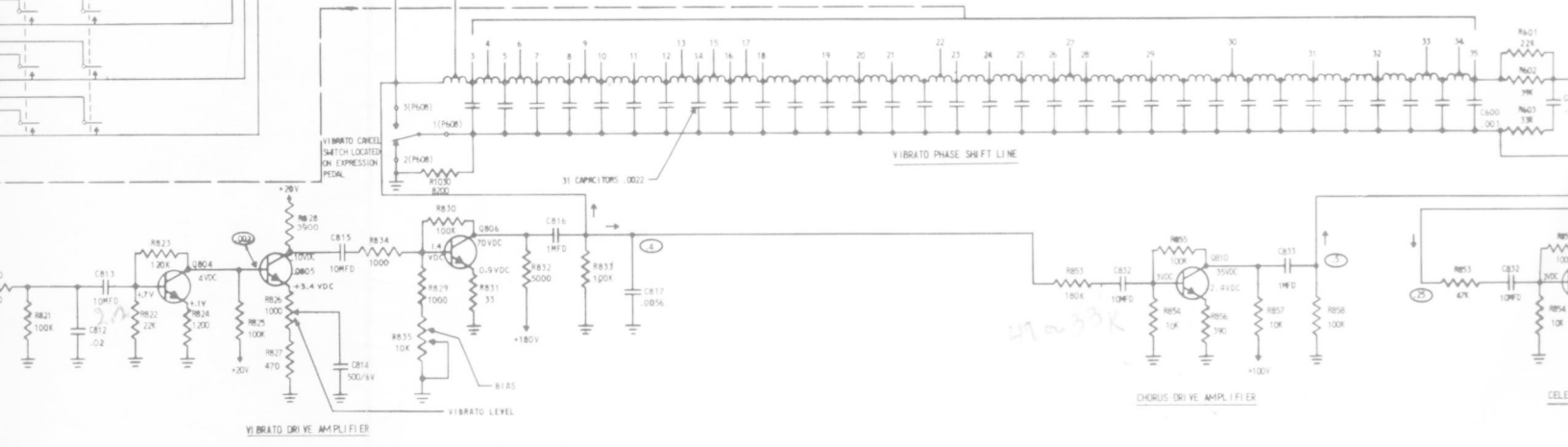
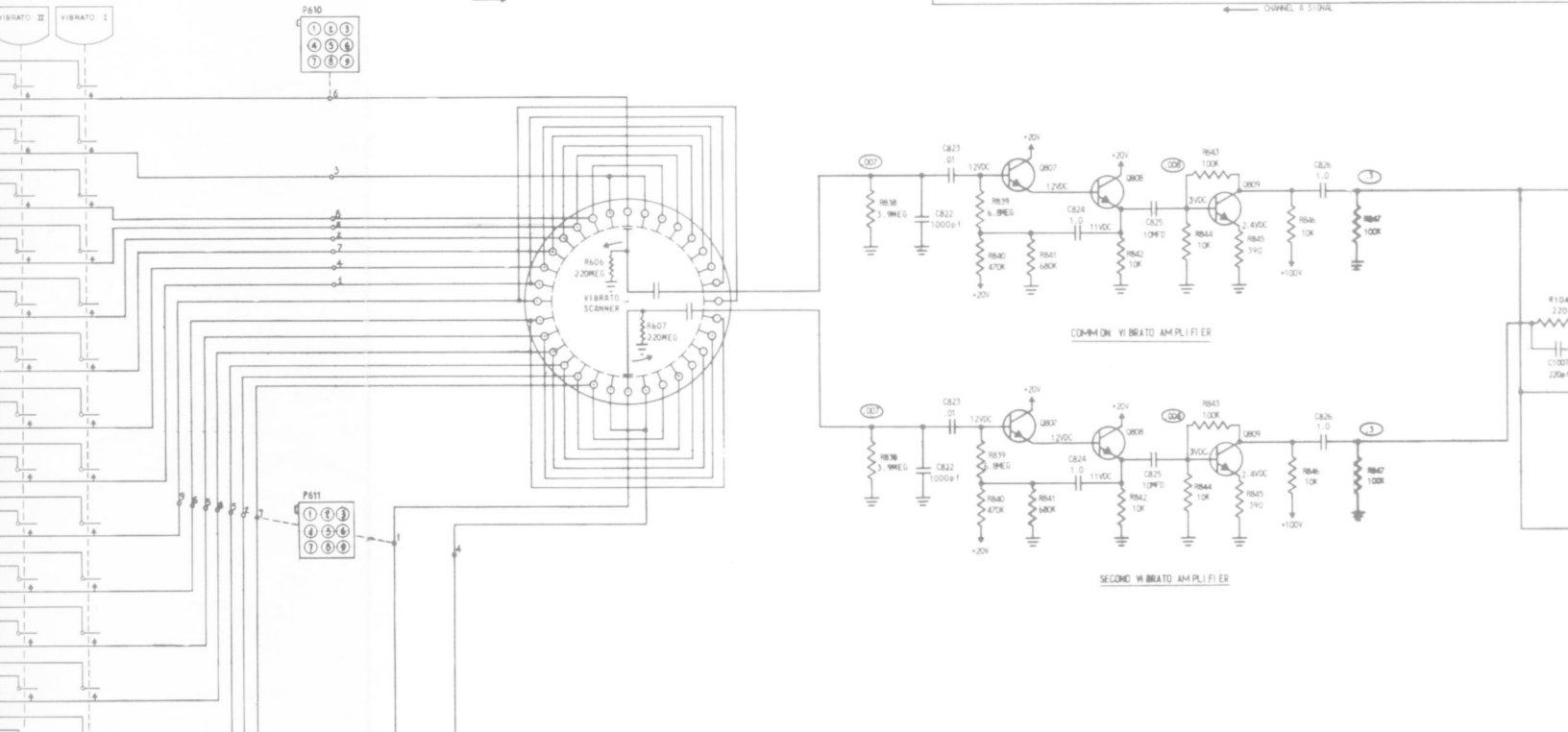
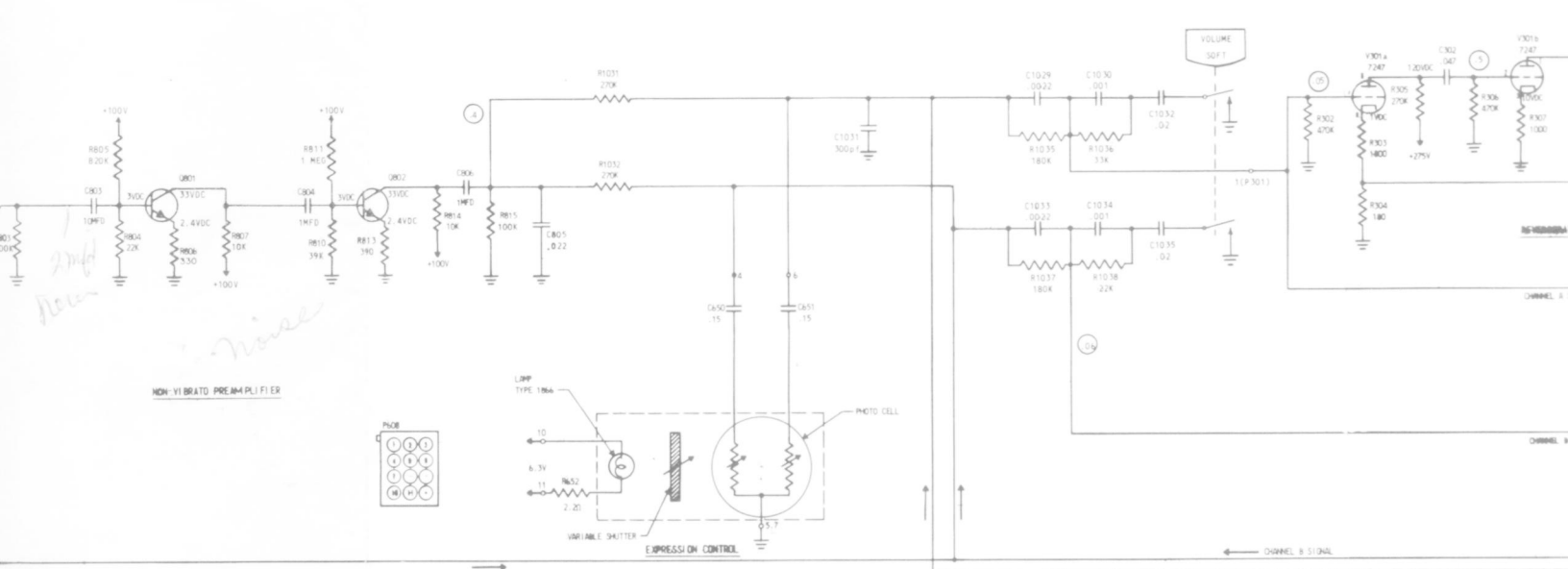

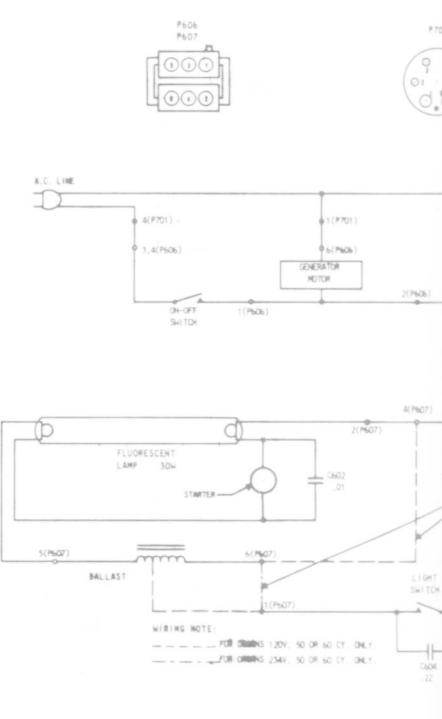
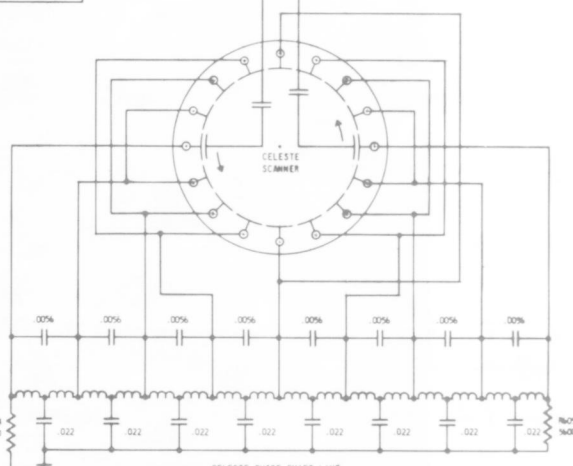
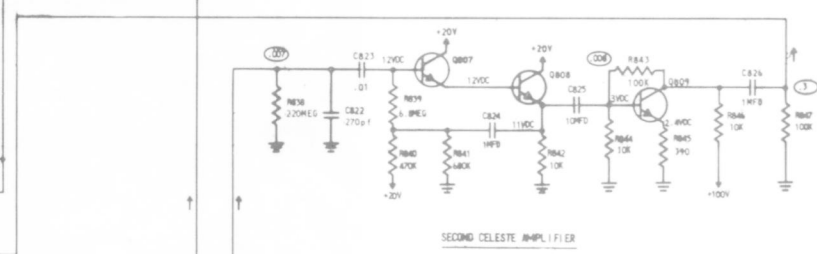
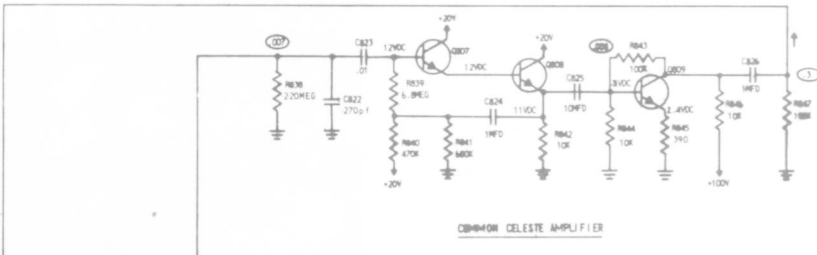
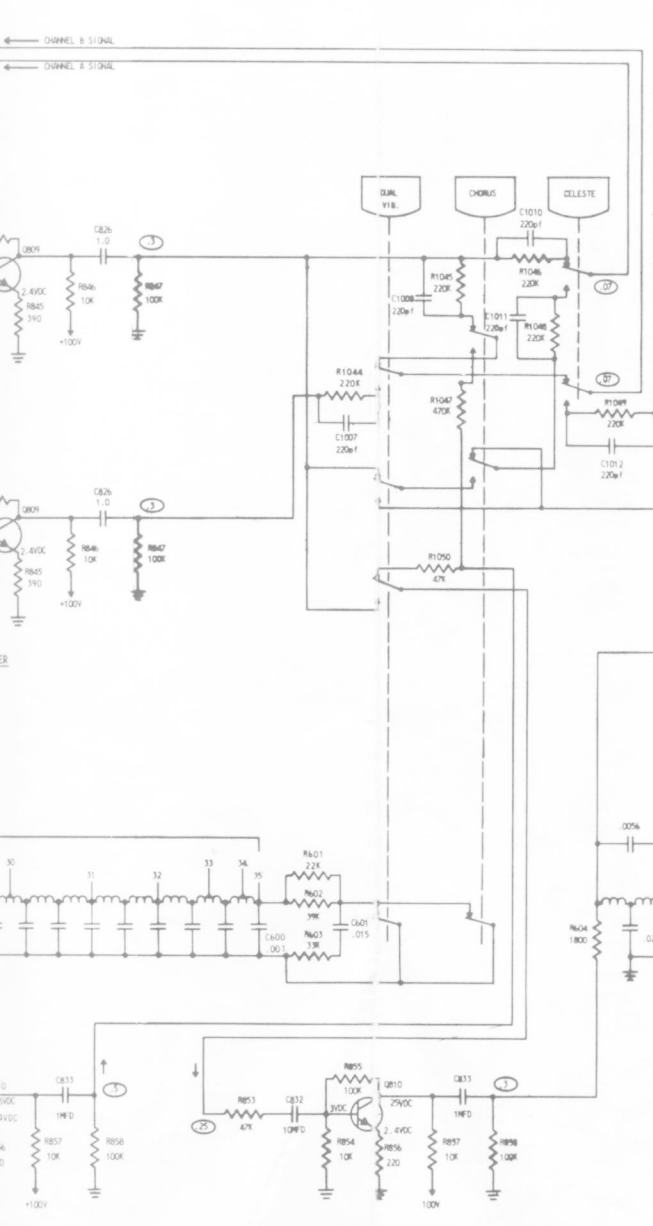
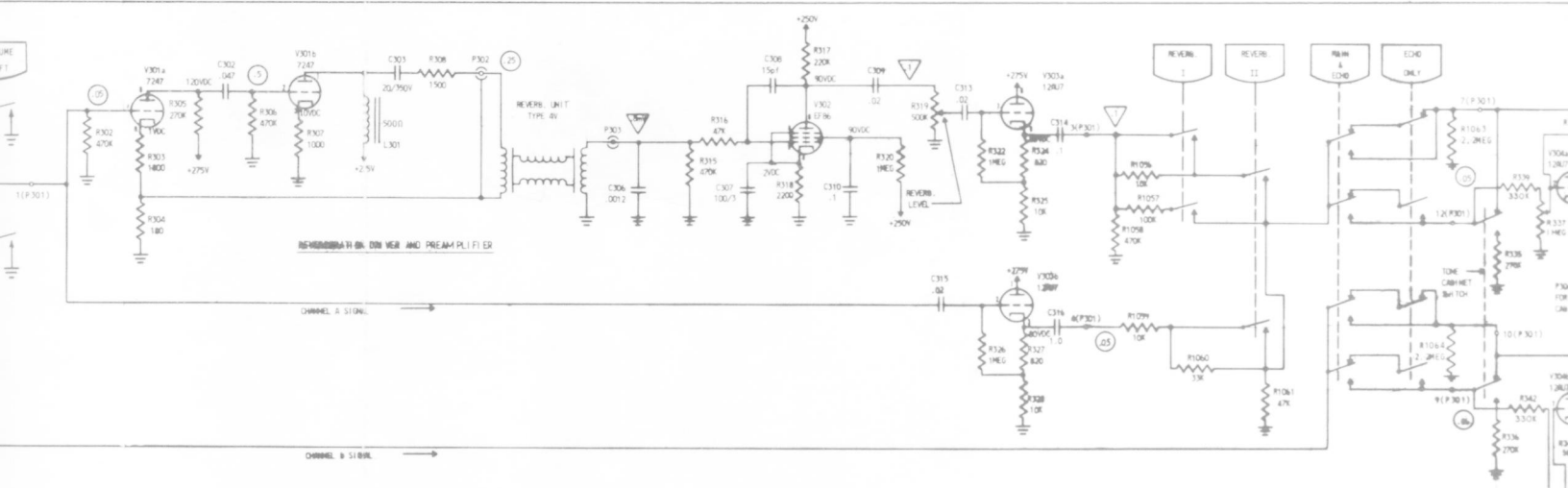

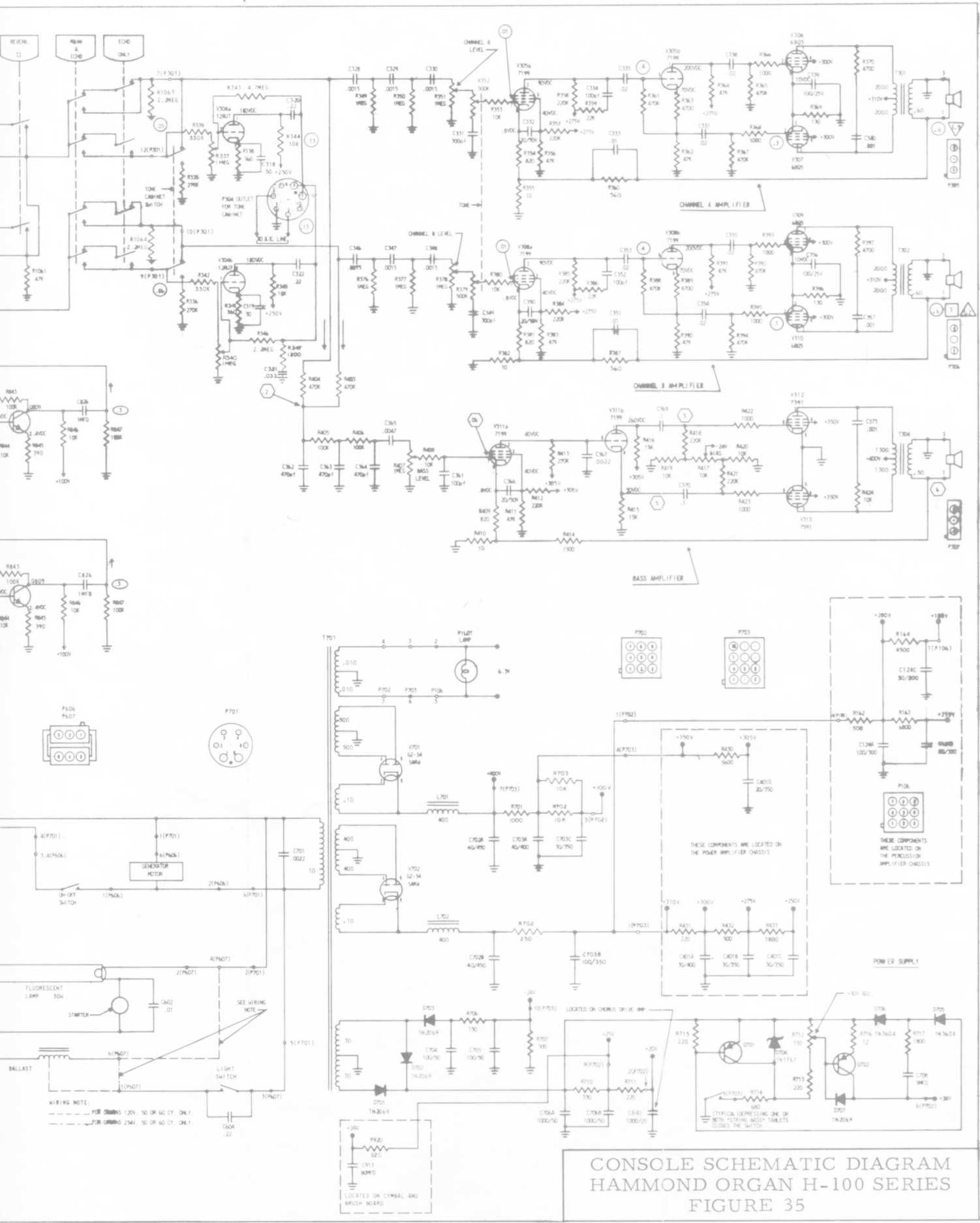

CONSOLE SCHEMATIC DIAGRAM
 HAMMOND ORGAN H-100 SERIES
 FIGURE 35

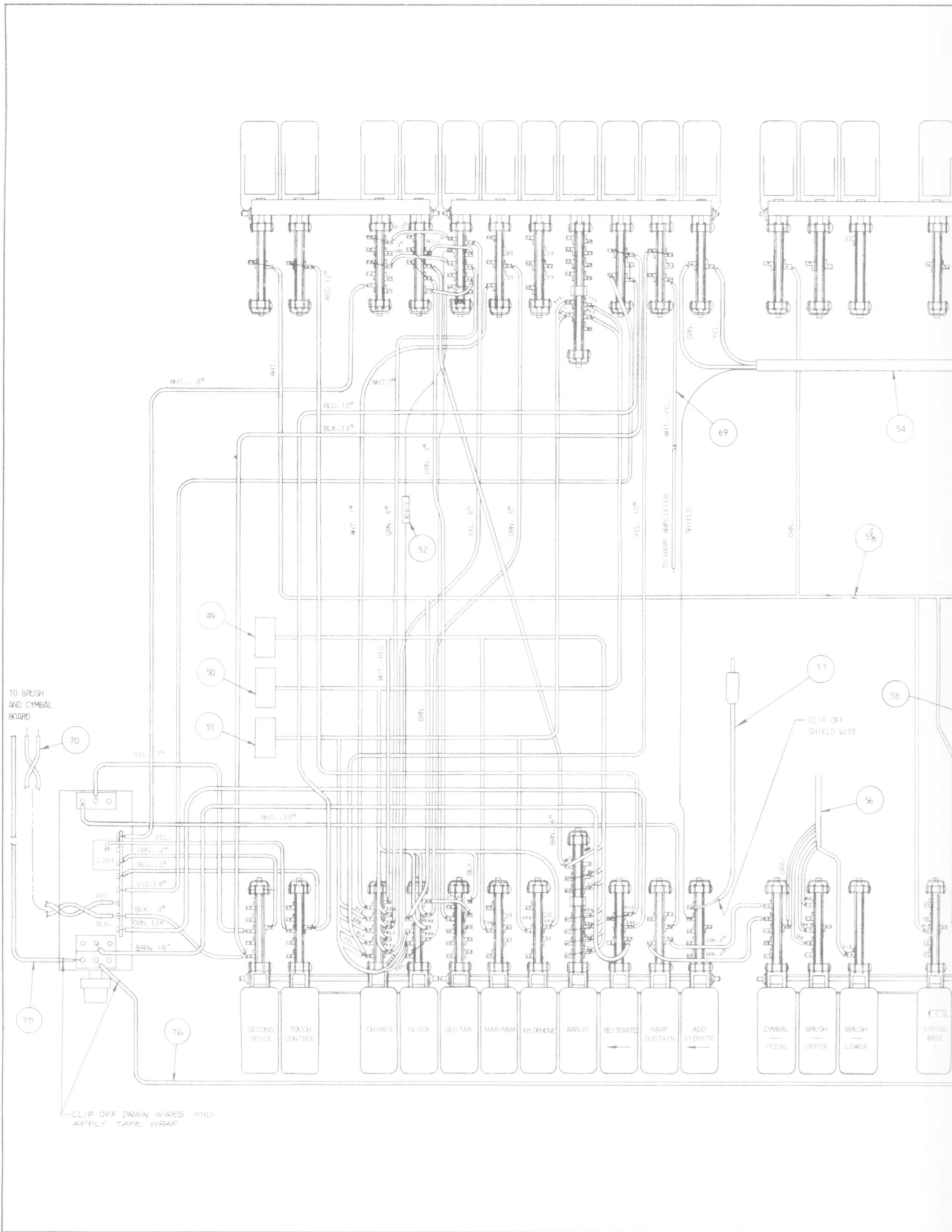

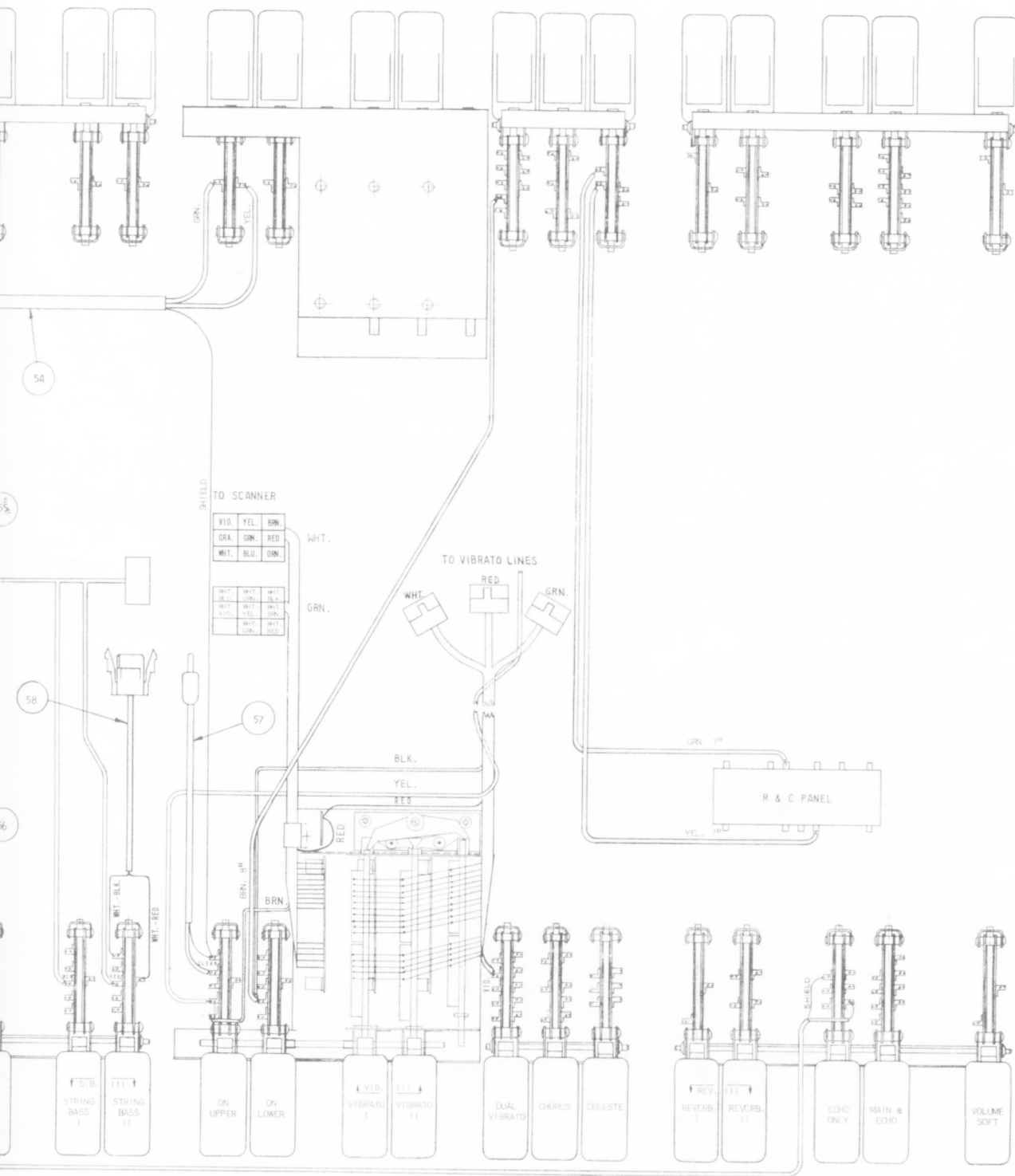

CONSOLE CONTROL
 PANEL WIRING
 FIGURE 36

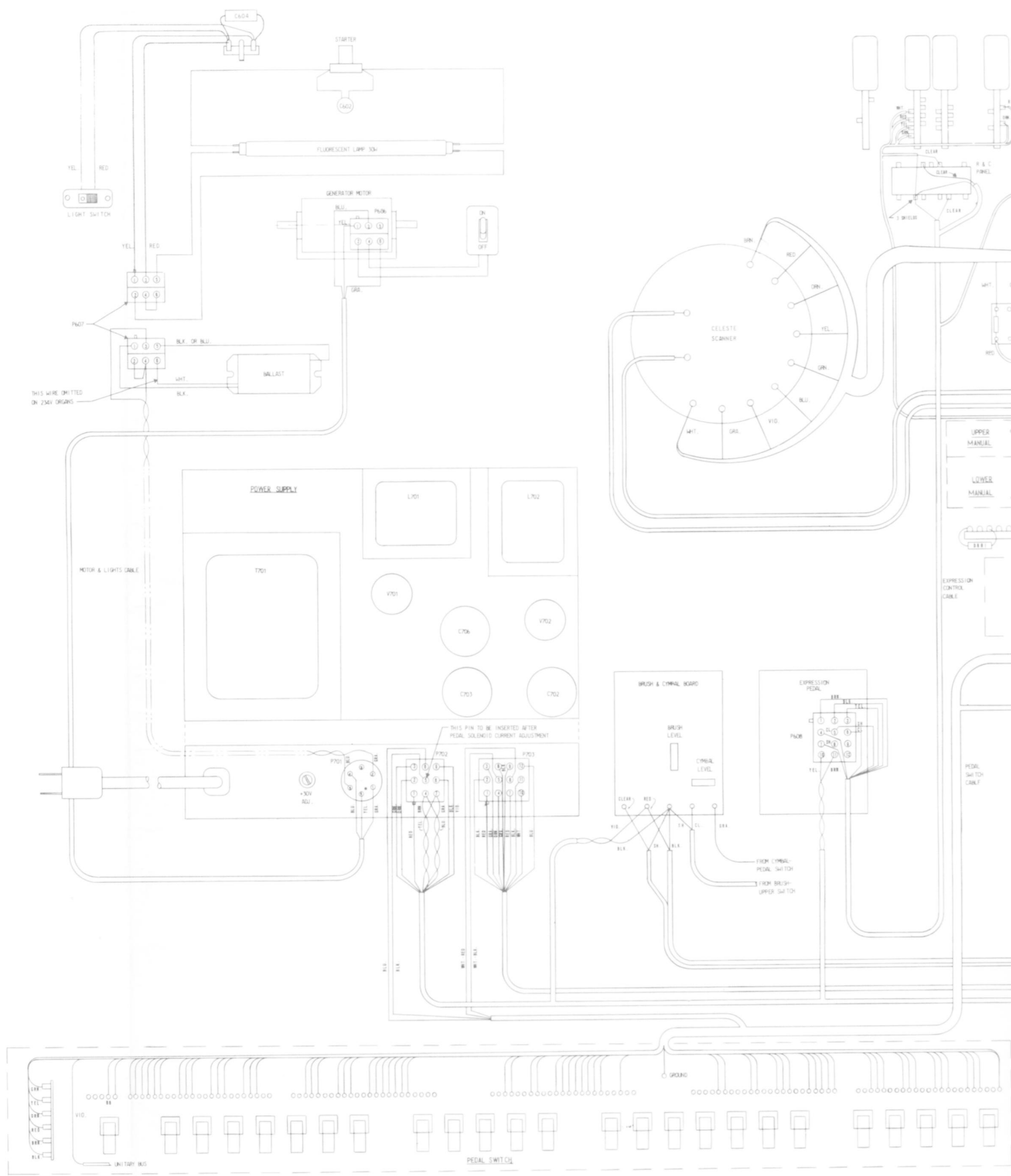

WHT - VIO. GRN.
 WHT - BLU. YEL.
 WHT - GRN. GRN.
 WHT - YEL. BLU.
 WHT - GRN. VIO.
 WHT - RED. GRN.
 WHT - BRN. WHT.
 WHT - BLK. RED.

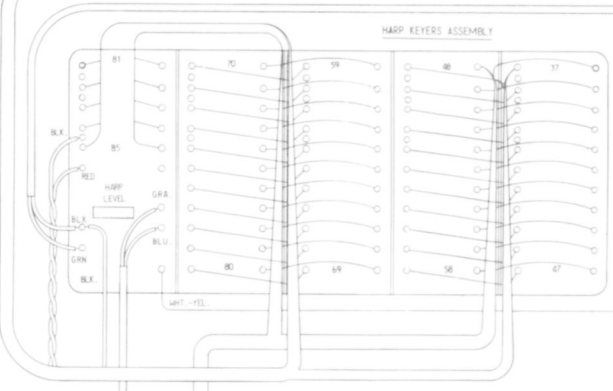
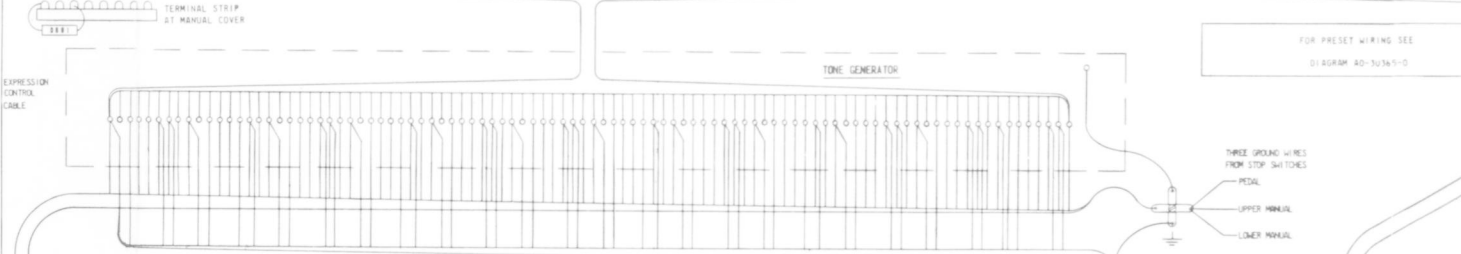
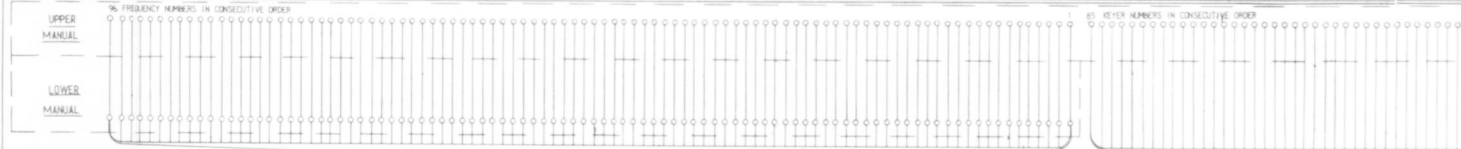
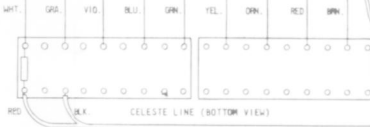
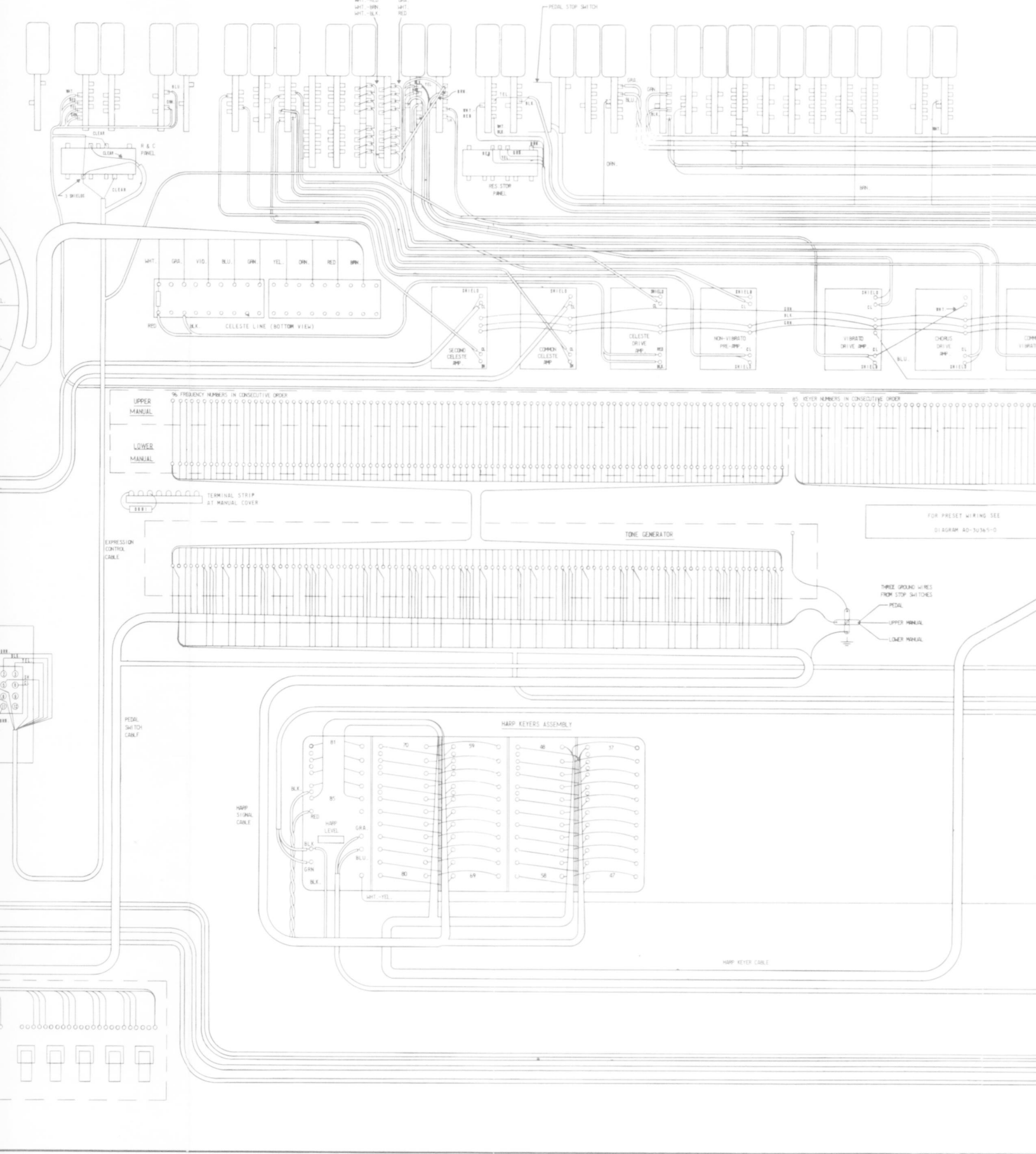

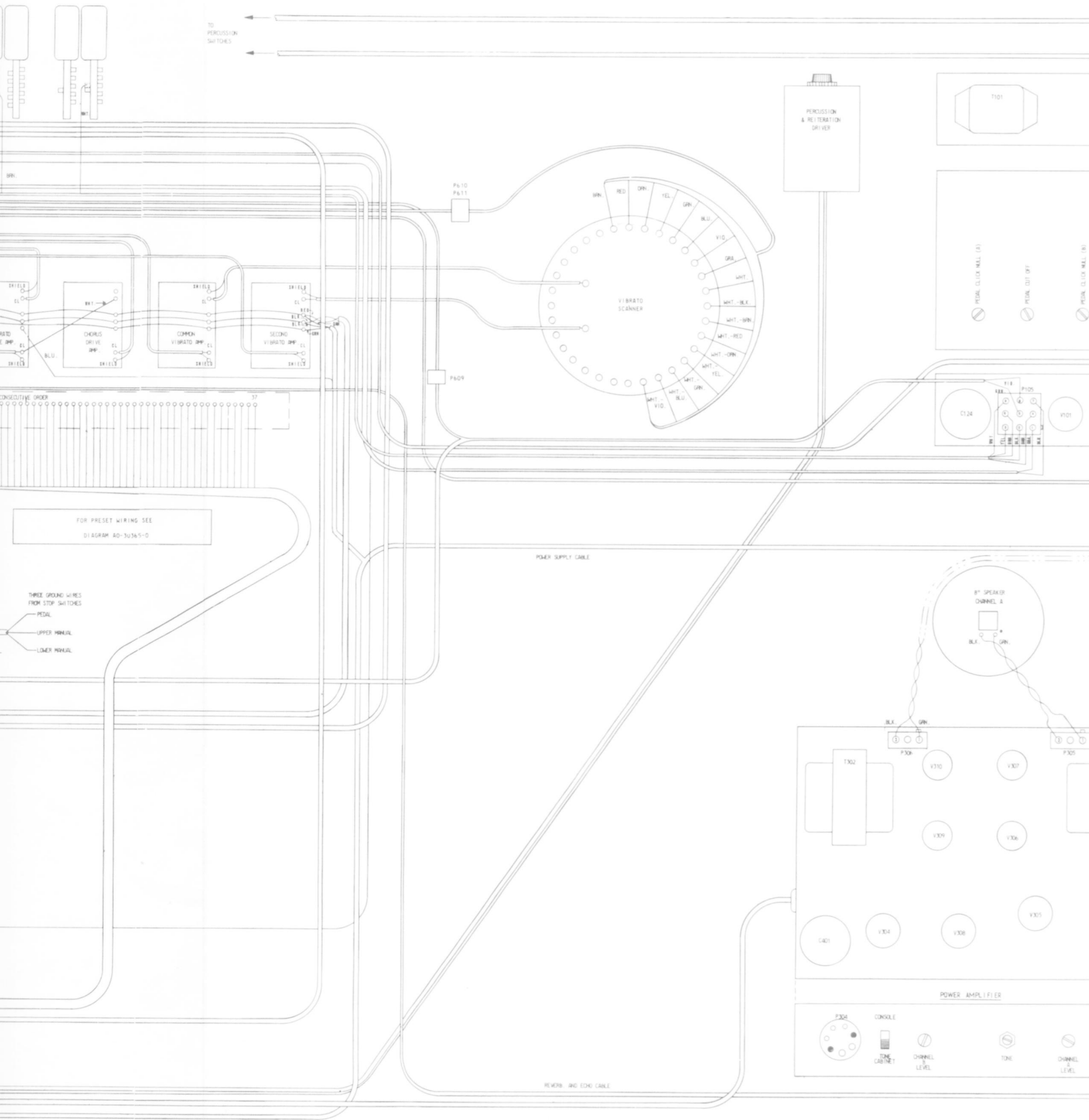

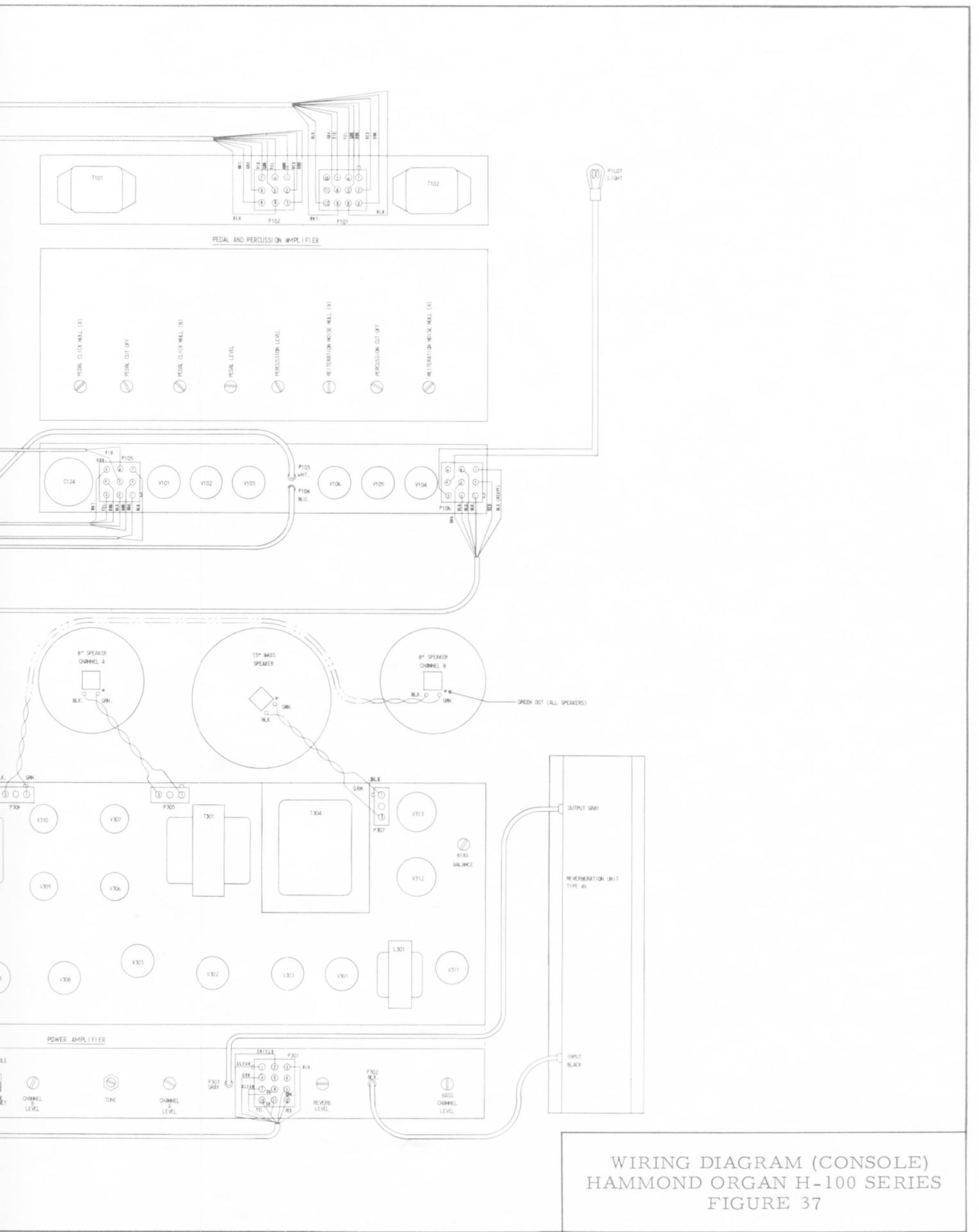

WIRING DIAGRAM (CONSOLE)
HAMMOND ORGAN H-100 SERIES
FIGURE 37

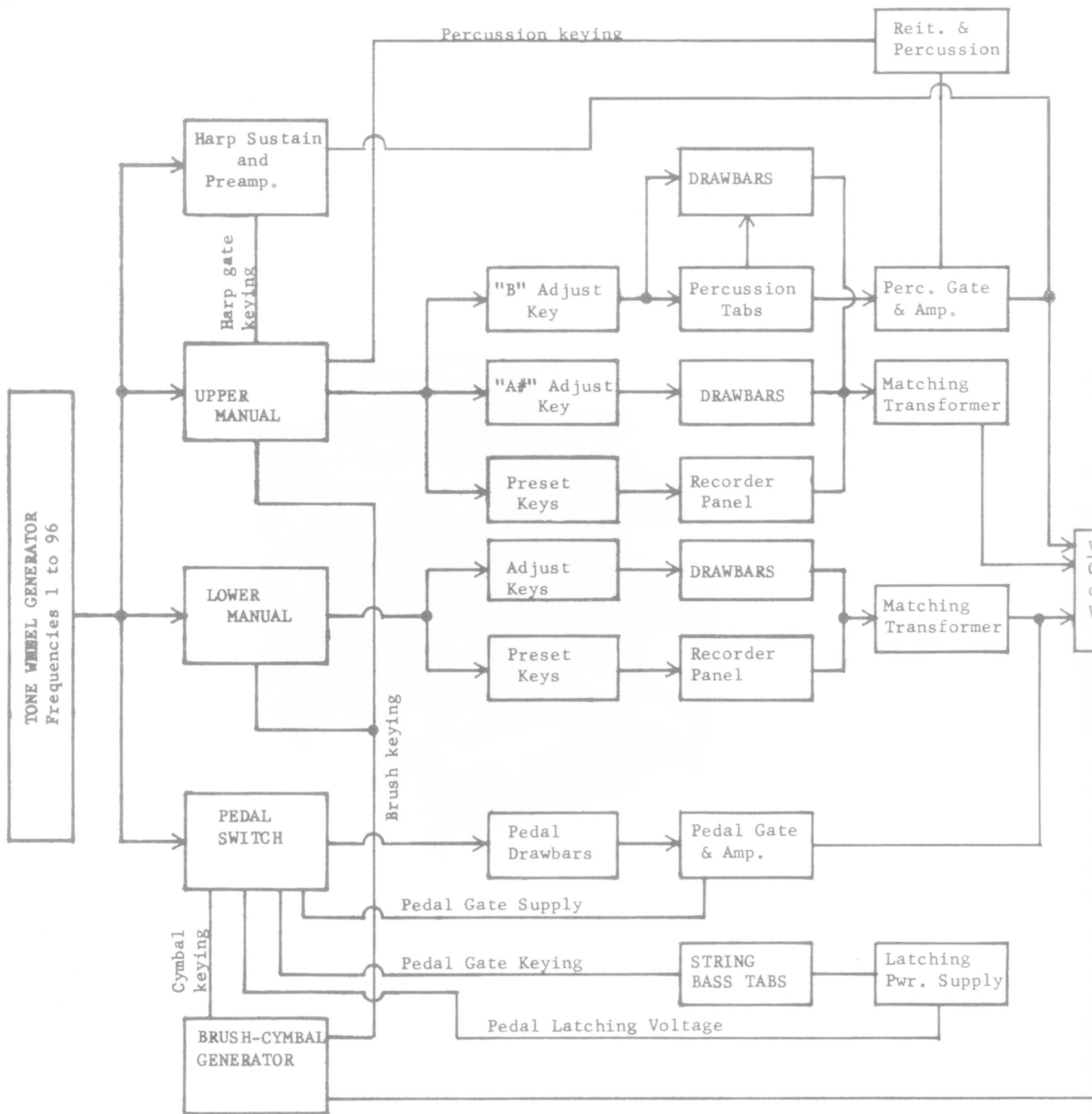

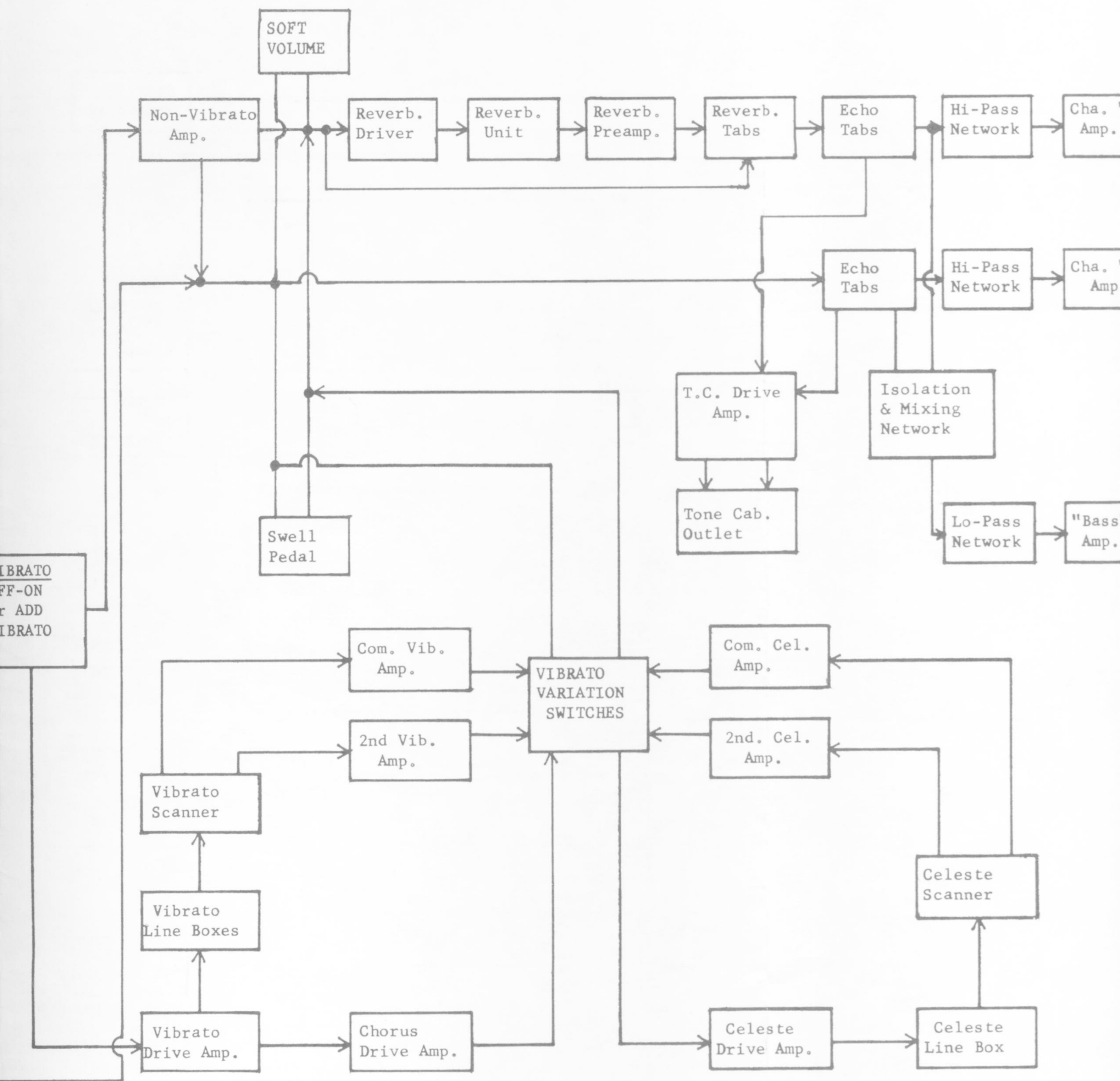

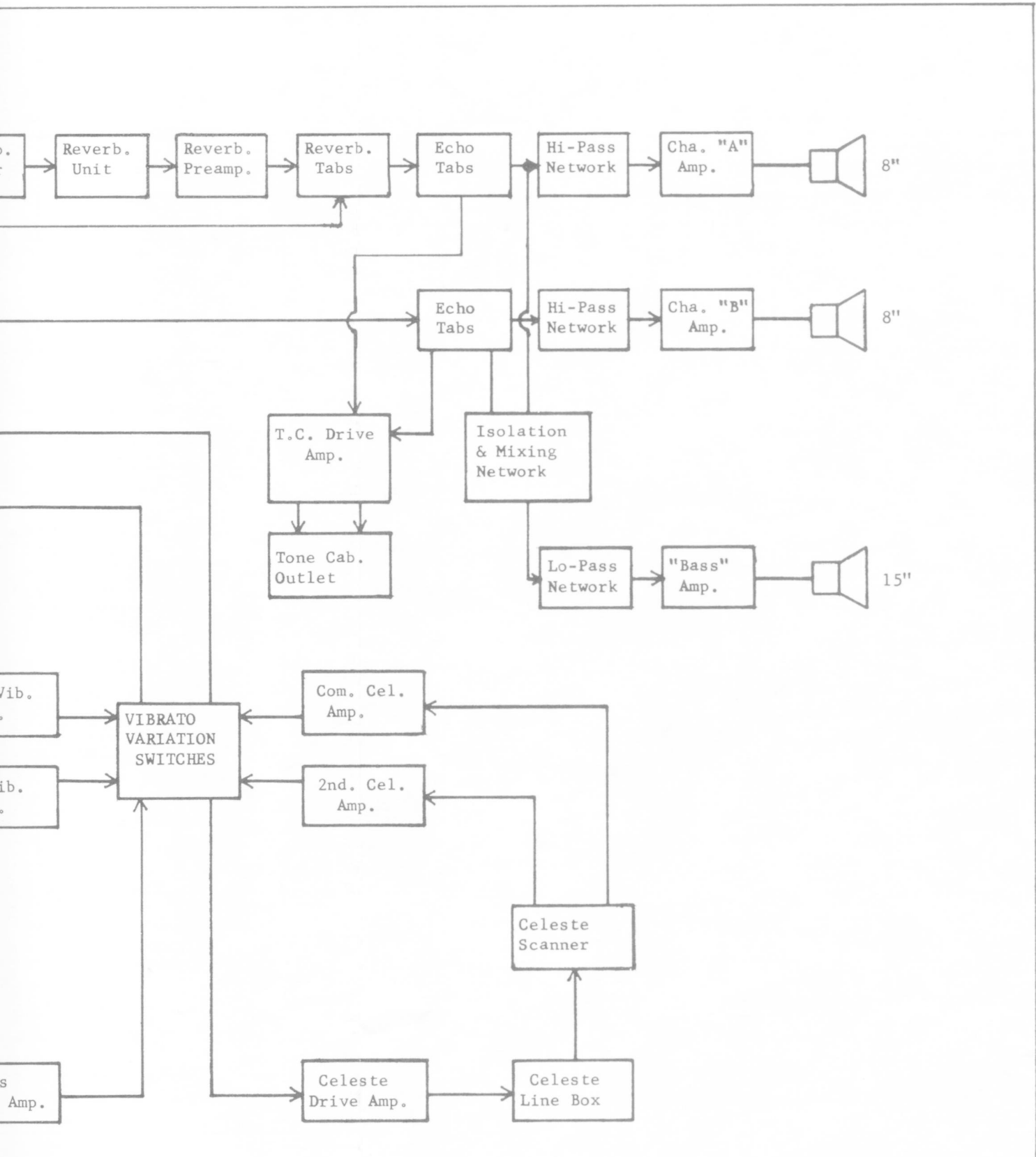

BLOCK DIAGRAM
H-100 SERIES
FIGURE 38