

# SERVICE MANUAL

X T P  
S  
E  
V  
E  
N  
M  
O  
D  
E  
L  
S



**HAMMOND ORGAN COMPANY**  
**DIVISION OF HAMMOND CORPORATION**

1740 N. 25th Avenue • Melrose Park, Ill. 60160  
312-378-5472 • 312-345-3100

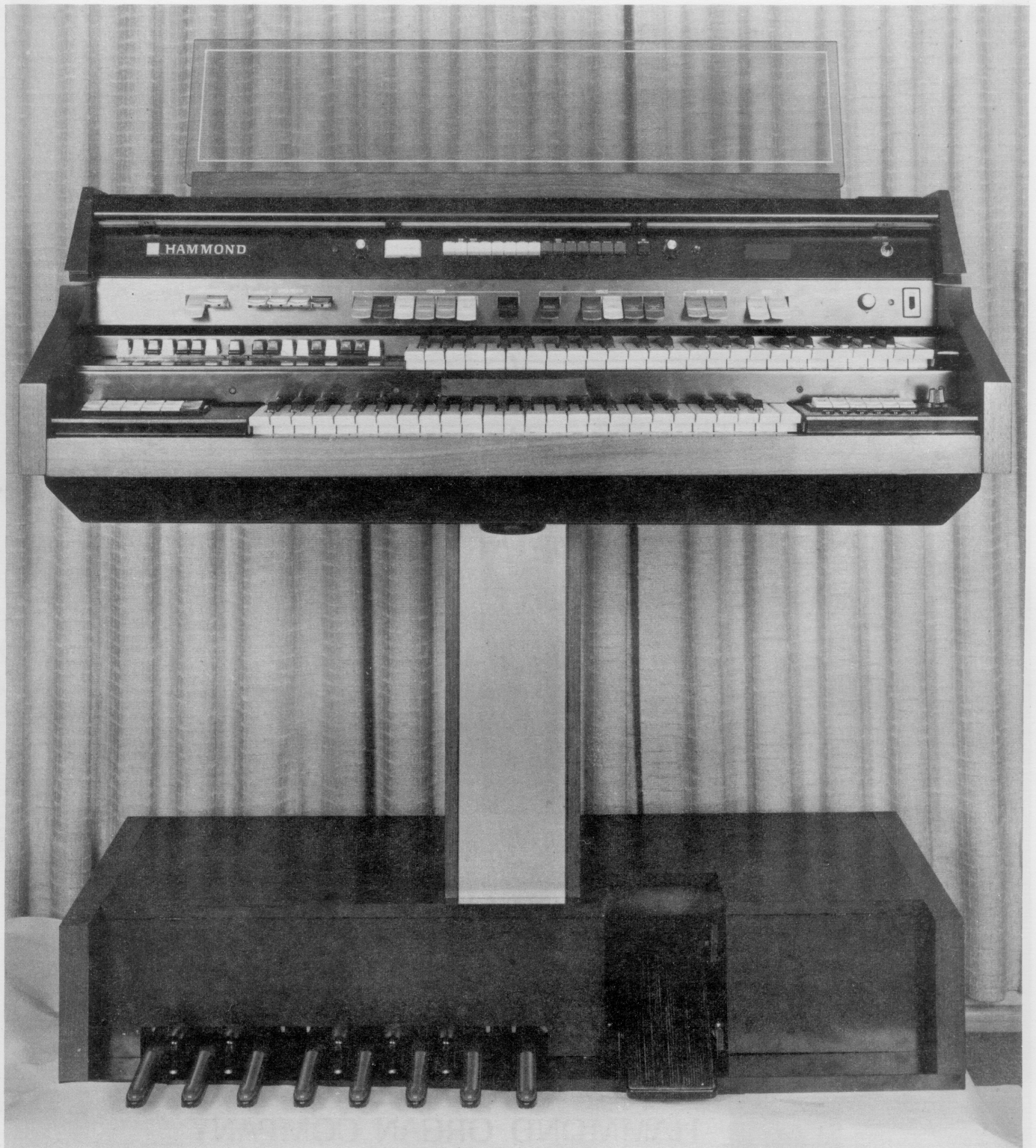

HAMMOND ORGAN COMPANY  
DIVISION OF HAMMOND CORPORATION  
115-125-1111  
NEW YORK, N.Y. 10001

**XTP**



# TABLE OF CONTENTS

	<i>Page</i>
Introduction .....	v
Specifications .....	v
<b>SECTION I – How the Organ Operates</b>	
1-1 General .....	1-1
1-2 Basic Descriptions .....	1-1
1-3 Tone Source .....	1-3
1-4 Pedal Tones .....	1-4
1-5 Manuals .....	1-4
1-6 Pedal Keyboard .....	1-6
1-7 Harmonic Drawbars .....	1-6
1-8 Pedal Drawbar .....	1-7
1-9 Expression Pedal .....	1-7
1-10 Control Tabs .....	1-8
1-11 Preset Tabs .....	1-8
1-12 Percussion Control Tabs .....	1-8
1-13 Vibrato Tabs .....	1-8
1-14 Reverberation .....	1-8
1-15 Volume Soft, Brilliance, Reiteration Rate .....	1-8
1-16 Pedal Rocker Tabs, Lower Left End Block .....	1-8
1-17 Leslie Rocker Tabs .....	1-8
1-18 Cymbal/Brush Tabs .....	1-8
1-19 Rhythm Rail (T-300) .....	1-8
1-20 Rhythm Rail Controls .....	1-9
1-21 T-200-1, T-200-2, T-400 Rhythm Controls .....	1-9
1-22 Rhythm Voices .....	1-9
1-23 Operation of Controls .....	1-9
<b>XTP</b>	
1-24 General (XTP) .....	1-9
1-25 Power & Reverbration Amplifier .....	1-9
1-26 Rhythm II Inbuilt .....	1-9
1-27 Upper Manual Buss Amplifier .....	1-9
<b>SECTION II – Theory of Operation</b>	
2-1 General .....	2-1
2-2 Tone Generator .....	2-1
2-3 Vibrato system .....	2-1
2-4 Manual Bus Bar Amplifiers .....	2-3
2-5 Pedal Keyboard and Switch; Pedal Keyer Boards .....	2-3
2-6 Pedal Divider and Filter Board .....	2-4
2-7 Recovery and Non-Vibrato Board .....	2-4
2-8 Vibrato Board .....	2-4
2-9 Percussion Board .....	2-5
2-10 Cymbal and Brush Generator Board .....	2-6
2-11 Swell Pedal Circuitry .....	2-6
2-12 Power and Reverberation Amplifier Assembly .....	2-7
2-13 Rhythm Rail Circuits, T-300 only .....	2-7
2-14 Power Supply .....	2-7
2-15 Push Button Circuits .....	2-7
2-16 Upper Manual Keying .....	2-8
2-17 Lower Manual Keying .....	2-9

2-18	Manual Beat II	2-9
2-19	Pedal Keying Circuits	2-10
2-20	Pedal Beat II	2-10
2-21	Six-Voice End Block Rhythm, T-200-1, T-200-2, T-400	2-10
2-22	Power Source	2-10
2-23	Push Button Circuits	2-10
2-24	Lower Manual Keying Circuits	2-11
2-25	Pedal Keying Circuits	2-11
2-26	Phone Jack	2-11
2-27	Special Power Sources	2-11

## XTP

2-28	Percussion Board Assembly (124-000170)	2-11
2-29	1/4 Harmonic Generator	2-11
2-30	Normal Percussion Keying	2-12
2-31	Reiteration Keying and Triggering	2-12
2-32	Main and Alternate Channel Gates	2-12
2-33	Percussion Setup Procedure	2-13
2-34	Rotary Tremolo Unit (121-000132)	2-14
2-35	Hum	2-15
2-36	Tone Cabinet Outlet Box	2-15

### SECTION III – DISASSEMBLY

3-1	General	3-1
3-2	Organ Top (Removal of)	3-1
3-3	Upper Manual Key Removal	3-1
3-4	Lower Manual Key Removal	3-1
3-5	Drawbar Assembly (Entire or Partial Removal of)	3-1
3-6	Pedal Drawbars Assembly (Removal of)	3-1
3-7	Lower Manual End Blocks (Removal of)	3-1
3-8	Upper Manual (Removal of)	3-2
3-9	Lower Manual (Removal of)	3-2
3-10	Tone Generator (Removal of)	3-2
3-11	Power Amplifier (Removal of)	3-2
3-12	Pedal Sustain Keyer (Removal of)	3-2
3-13	Pedal Switch Assembly (Removal of)	3-2

## XTP

3-14	Top Panel Assembly	3-3
3-15	Upper Console Woodwork	3-3
3-16	Pedal Base Top Cover	3-3
3-17	Pedestal Woodwork	3-3
3-18	Base Rear Cover	3-4
3-19	Music Light Assembly	3-4

### SECTION IV – Practical Service Suggestions

4-1	General	4-1
4-2	Percussion Board Alignment	4-1
4-3	Replacing Older Percussion Boards	4-1
4-4	Pedal, Correction of Faulty Operation	4-3
4-5	Radio Frequency Interference Problems	4-4
4-6	Inductive Pickup in Non-Vibrato Board	4-5
4-7	New Vibrato Drive Board, 124-000018	4-5
4-8	Tab Replacement	4-5
4-9	Maintenance of Leslie Speaker	4-7
4-10	Music Illumination System, T-262	4-8

4-11	Raising Organ on Deep Pile Carpeting .....	4-8
4-12	Six Voice Rhythm, T-200-1, T-200-2, T400, Adjustment and Trouble Analysis .....	4-9
4-13	Output Level Adjustments .....	4-9
4-14	One Rhythm Voice Silent .....	4-9
4-15	Programmed Voice Does Not Speak .....	4-9
4-16	All Percussion Voices Silent .....	4-9
4-17	Both Hiss Voices Silent .....	4-9
4-18	No Rhythm Response from Pedals .....	4-10
4-19	No Rhythm Response from Manual .....	4-10
4-20	Rhythm Rail Adjustments .....	4-10
4-21	Overall Organ Level Adjustment .....	4-10
	Table 4-1, Alignment and Performance Check .....	4-12

## **XTP**

4-22	Overall XTP Level Adjustment Table 4-2. Alignment and Performance Check .....	
------	--	--

### **SECTION V – Diagrams**

5-1	General .....	5-1
5-2	Arrangement of Section .....	5-1

### **SECTION VI – Parts List**

6-1	General .....	6-1
-----	---------------	-----

### **APPENDIX**

Appendix Index .....	A-1
----------------------	-----



# LIST OF ILLUSTRATIONS

<i>Figure</i>	<i>Page</i>
1-1	Typical T-Series Organ, Front View . . . . . 1-1
1-2	Typical T-Series Organ, Rear View . . . . . 1-2
1-3	Rhythm Rail . . . . . 1-3
1-4	Six-Voice End Block . . . . . 1-3
1-5	Magnet Locations on Tone Generator . . . . . 1-4
1-6	Filter Locations and Frequency Terminations on Generator Cover . . . . . 1-4
1-7	Manual Wiring Chart . . . . . 1-5
1-8	Drawbars and Control (Tabs Partial View) . . . . . 1-6
1-9	Pedal Keyboard . . . . . 1-7
2-1	Typical Tone Generator . . . . . 2-1
2-2	Vibrato System, Fundamental Diagram . . . . . 2-2
2-3	Vibrato Line Box . . . . . 2-2
2-4	Typical Scanner . . . . . 2-3
2-5	Percussion Null Waveshapes . . . . . 2-13
2-6	Main Level and Reiteration Rate . . . . . 2-13
2-7	Main Speaker Cabinet . . . . . 2-15
2-8	Rotary Tremolo Speaker Cabinet. . . . . 2-15
3-1	Woodwork Disassembly . . . . . 3-3
3-2	Woodwork Disassembly . . . . . 3-3
3-3	Base Rear Cover Assembly . . . . . 3-4
3-4	Music Light Assembly . . . . . 3-4
4-1	Percussion Board Conversion, Cabling to Switches . . . . . 4-2
4-2	Percussion Board (124-000181) Cabling . . . . . 4-2
4-3	Tab Switches, Addition of Capacitors . . . . . 4-4
4-4	Percussion Board, Addition of Capacitors . . . . . 4-5
4-5	Reverb Switches, Addition of Capacitors . . . . . 4-5
4-6	Bottom Rail Construction . . . . . 4-8
4-7	Placement of Glides . . . . . 4-9
4-8	Upper Console Components Location . . . . . 4-10
4-9	Lower Console Components Location . . . . . 4-11
5-1	Pedal Divider Board, (124-000013), Layout and Schematic Diagram . . . . . 5-2
5-2	Recovery and Non-Vibrato Board (124-000014), Layout and Schematic Diagram . . . . . 5-3
5-3	Upper Manual, Layout and Schematic Diagram Bus Amplifier Board (124-000015) . . . . . 5-4
5-4	Lower Manual, Layout and Schematic Diagram Bus Amplifier Board (124-000016). . . . . 5-5
5-5	Power and Reverberation Amplifier Board (124-000017), Layout and Schematic Diagram . . . . . 5-6
5-6	Vibrato Board (124-000018), Layout and Schematic Diagram . . . . . 5-7
5-7	Brush and Cymbal Generator Board 124-000020 (First Design) . . . . . 5-8
5-8	Brush and Cymbal Generator Board 124-000020 (Second Design) . . . . . 5-8
5-9	Brush and Cymbal Generator Board 124-000020 (Third Design) . . . . . 5-8
5-10	Brush and Cymbal Generator Board (124-000020) Layout and Schematic Diagram 1969 and later . . . . . 5-9
5-11	Percussion Board, 124-000021 . . . . . 5-10
5-12	Percussion Board, 124-000181 Layout and Schematic Diagram . . . . . 5-10

5-13	Percussion Board, 124-000113 (T-262 only)	
	Layout and Schematic Diagram	5-11
5-14	Pedal Keyer Boards, 124-000025, 124-000026, 124-000027	
	Layout and Schematic Diagram	5-12
5-15	Pedal Keyer Board Assembly	5-13
5-16	Power Supply, Schematic Diagram	5-14
5-17	Console, Schematic Diagram (Sheet 1 of 2)	5-16
5-17	Console, Schematic Diagram (Sheet 2 of 2)	5-17
5-18	Rhythm Rail, Layout and Schematic Diagram	5-18
5-19	Rhythm Rail, Wiring Diagram	5-19
5-20	Six-Voice Rhythm, Layout and Schematic (First Design)	5-20
5-21	Six-Voice Rhythm, Layout and Schematic (Second Design)	5-21
5-22	Six-Voice Rhythm, Layout and Schematic (1970 and later)	5-22
5-23	Six-Voice Rhythm, Wiring Diagram	5-23
5-24	T-100 Wiring Diagram	5-24
5-25	T-200 Wiring Diagram	5-25
5-26	T-300 Wiring Diagram	5-26
5-27	T-262 Wiring Diagram	5-27
5-28	T-200-1, T-200-2, T-400	5-28
5-29	Upper Manual and Control Panel T-100, T-200, T-300	
	Wiring Diagram	5-29
5-30	Upper Manual and Control Panel T-262	
	Wiring Diagram	5-30
5-31	T-100, T-200, (First Design) Schematic Diagram	5-31
5-32	T-100, T-200, (Second Design) Schematic Diagram	5-32
5-33	T-262, Schematic Diagram (Sheet 1 of 2)	5-34
5-33	T-262, Schematic Diagram (Sheet 2 of 2)	5-35
5-34	Six-Voice Rhythm End Block Wiring (Lower Right)	5-36
5-35	Special Effects End Block (Lower Left)	5-36
5-36	Rotary Tremelo Schematic (Satellite Cabinet)	5-36
5-37	Percussion Board (124-000170), Layout and Schematic	5-37
5-38	XTP Schematic Sheet 1 of 2	5-38
5-39	XTP Schematic Sheet 2 of 2	5-39
5-40	Power Amplifier (126-000170-172) Wiring Diagram	5-40
5-41	XTP Wiring Diagram	5-41

## INTRODUCTION

This manual contains service information covering the T-Series Hammond organs. The series is comprised of the following models:

T-100	T-262
T-200	T-300
T-200-1	T-400
T-200-2	

The features of each model are explained in Section I.

Model T-200-2 is equipped with "drawer" type Rhythm II circuitry; model T-400 is equipped with built-in Rhythm II circuitry. No service information for Rhythm II is included in this manual. Refer to Rhythm II Service Manual, H0-466. For convenience in locating desired information, this manual is divided into the sections listed below.

- I How the Organ Operates
- II Theory of Operation
- III Disassembly
- IV Practical Service Suggestions
- V Diagrams
- VI Parts List
- Appendix

All pertinent Technical Bulletins issued through May 1970 are reprinted in Section IV.

All pertinent Technical Bulletins issued through January 1970 are reprinted in the Appendix.

### NOTE

The service technician may find some model T-100 organs with Rhythm Rail attached. In such cases the Rhythm Rail has been installed in the field, using a kit. No factory installation was made on T-100 organs. Field installations of "drawer" Rhythm II may also be encountered on any model except T-400.

### SPECIFICATIONS

Cabinet Size  
45" Wide  
25" Deep  
44½" High with Music Rack

Weight with Bench T-100-215 lbs.  
Weight with Bench T-200-235 lbs.  
Weight with Bench T-300-240 lbs.  
Weight with Bench T-400-245 lbs.  
Power Input T-100 - 0.7 Amps.  
Power Input T-200/300/400 - 1.2 Amps.  
Music Power Output - 34 Watts  
(Per EIA Standards - RS-234).

### XTP

Cabinet Size  
43¼" Wide  
28¼" Deep  
44½" High with Music Rack

Satellite Speakers  
16½" Wide  
17" Deep  
20½" High

Console Weight 289 lbs.  
Console with Spkrs. 354 lbs.  
Console, Bench, Spkrs. 384 lbs.

Music Power Output 34 Watts



in a left-of-center position. Fastenings are provided which permit the unit to swing down and lock under the lower manual for shipment or concealment when not in use.

The electronic portions of the Rhythm unit are mounted within the console, and consist of the power supply (127-000007), rhythm unit detector (124-000024), and rhythm unit voice boards (124-000023).

Ten voices appear on the Rhythm Rail. They are from left to right:

- |               |                 |
|---------------|-----------------|
| 1. Drum Roll  | 6. Tom Tom      |
| 2. Snare Drum | 7. Bongo        |
| 3. Bass Drum  | 8. Temple Block |
| 4. Cymbal     | 9. Wood Block   |
| 5. Brush      | 10. Claves.     |

- 1-20. RHYTHM RAIL CONTROLS.** –The ten voices may be placed at any time by means of momentary push buttons. They can also be programmed into the upper manual, lower manual, or pedals, by means of a 4-position slider switch associated with each voice and a “Preset” switch at the extreme left of the Rhythm Rail. Moving the “Preset” switch to the “Off” position cancels the programming.

A variation in programming is provided by the BEAT II feature.

When the BEAT II switch is in the Manual position, and Preset switch is on, voices selected for the upper manual are triggered by the first depressed key of the lower manual. Subsequently depressed keys of the lower manual trigger the voice (s) selected for the lower manual.

When the BEAT II switch is in the Pedal position and Preset switch is On, voices selected for upper manual, except Drum Roll, are triggered by release of a Bass pedal, while Drum Roll and voices selected for Pedal are triggered by depressing a Bass pedal.

A three position slider switch regulates the loudness of the Rhythm Rail voices relative to the organ. The expression pedal also affects the Rhythm Rail.

- 1-21. T-200-1, T-200-2, T-400 RHYTHM CONTROLS.** – The rhythm controls are located on the right end block of the lower manual.

- 1-22. RHYTHM VOICES.** – The following voices are available.

BLOCK	BONGO
CYMBAL	TOM-TOM
BRUSH	CLAVES

The BLOCK voice is identical to the Wood Block on the T-300 organ.

- 1-23. OPERATION OF CONTROLS.** –Any of the six voices may be played at any time by means of the momentary push buttons associated with the rocker tabs.

The BLOCK and CYMBAL voices are programmed into the pedal keyboard when their rocker tabs are “on”. The remaining four voices are programmed into the lower manual keys when their rocker tabs are “on”.

The RHYTHM VOLUME control, mounted to the right of the rocker tabs, regulates the loudness of the rhythm voices relative to the other organ voices. The organ’s expression pedal also affects the rhythm voices.

The BRUSH and CYMBAL voices sound without reverberation. The remaining voices are reverberated whenever a REVERB tab on the organ’s control panel is depressed.

## XTP

- 1-24. GENERAL (XTP).** – With the “T” Series service manual HO-431, and this supplement, the complete organ systems will be covered. This publication only covers the differences or variations of this unit from the “T” Series Spinets.

- 1-25. POWER AND REVERBERATION AMPLIFIER BOARD.** – This printed wiring board remains physically unchanged. Component value changes were incorporated to conform with the quick response photocell used in the XTP. Refer to Figure 5-5 in the “T” Series service manual, HO-431. Changes are as follows: R601-3.3M, R602-33K, R603-10K, R645-270K, C605-100 MFD/3V, C614-47Pf.

- 1-26. RHYTHM II INBUILT.** – The RHYTHM II assembly is of the improved variety. Service information will be found in the RHYTHM II service manual (HO-466).

- 1-27. UPPER MANUAL BUSS AMPLIFIER.** – Celesta output resistor R263 to pin 24 decreased in value to 15K ohms to increase output of celesta voice. Refer to Figure 5-3 in the “T” Series service manual for location.



When the BRUSH push button is depressed, +15V DC is supplied to the junction of R116 and C111, and this supplies bias through D102 to the base of Q103, turning "on" the one shot multi-vibrator stage, Q103 and Q104 for one complete cycle. The Brush Gate transistor Q105 is turned "on" for a period determined by C113 and R120 of the multi-vibrator stage. This applies positive bias through R123, D104, R124 to base of Q105, turning on Q105 and allowing white noise to appear on collector of Q105, tuned by C115 and L101, and this signal is then routed through C117 and output level control R126 and R127 to hiss amplifier Q106.

**2-24. LOWER MANUAL KEYING CIRCUITS.** – The lower manual buss line is connected through C124 to the base of Q109, which is a pulse amplifier stage. Resistor R147 provides base bias to the stage, so that with no key depressed, the collector is at approximately 4.5V DC. C124 and R145 is a differentiating network which puts a pulse on the base of Q109. This pulse is amplified by Q109, and instantaneously the collector of Q109 rises from 4.5V DC to approximately 11V DC. This change is routed through R149 to the base of Q110, which at an emitter voltage of 5.5V and base bias of 4.5V was "off". With 11V on its base, Q110 turns "on", and its collector, which was at 15V drops to 5.5V. This change is coupled through C126 and R153 to the base of Q111, a PNP which had been biased "off" through R152 and R153. The change in bias turns "on" Q111 and the collector has an instantaneous +15V DC output of about 2 milliseconds duration. This output is defined as the lower manual trigger pulse. The pulse is routed through whichever LOWER tabs are "on" to trigger the selected voices. Output is obtained as described in Paragraph 2-23.

**2-25. PEDAL KEYING CIRCUITS.** – In the T-Series organs the keying signal used to trigger the pedal rhythm circuits is a DC voltage change from +15V DC to 0V DC as a pedal is depressed. Point "A" is connected to point "D". The signal enters at point "C", and is fed through R160 to the base of Q114, which is normally in the "on" condition with no pedal pressed (collector at 0V DC). When a pedal is pressed, the negative signal applied to the base turns "off" Q114, and the collector voltage rises to +15V DC. Point "D" is routed to point "A" and

coupled through C127 and R156 to the base of Q112. Q112 which is normally "off" is turned "on", and its collector voltage drops to zero. The collector signal of Q112 is then fed to the base of PNP Q113, turning it "on", and its collector switches to +15V DC. This +15V DC pulse on the collector of Q113 is designated as the pedal-down pulse, and is routed through the BLOCK and/or CYMBAL tabs, when "on" to trigger the selected voices. Output is obtained as described in Paragraph 2-23.

**2-26. PHONE JACK.** – T-Series organs are equipped with an ear phone jack which will give pleasing results. Use Headsets such as Clark 200, Koss SP-3XC, or Sharp HA-10. When ear-phones are plugged in speakers are disconnected for listening privacy. Leslie effects are not heard in earphones.

**2-27. SPECIAL POWER SOURCES.** – T-Series organs are made to operate on the voltage and frequency specified on the name plate. They are available for 117V/60 cycle – 117V/50 cycle – 234V/50 cycle, and 234V/60 cycle. If the unit is moved to an area having voltages or frequencies other than those specified on the name plate, consult your local dealer concerning changes required for conversion.

## XTP

**2-28. PERCUSSION BOARD ASSEMBLY (124-000170).** – The following inter-related circuits are located on this board (See Figure 5-37):

1. 1¼ Harmonic Generator
2. Normal Percussion Keying
3. Reiteration Keying and Triggering
4. Main and Alternate Channel Gates.

**2-29. 1¼ HARMONIC GENERATOR.** – The output of this circuit is used only as part of the chimes voice.

The circuit receives its input at pin 11 from the upper manual 5th harmonic buss amplifier. The signal is amplified by Q514, Q515 and Q516. The resultant square wave output provides the input to IC 501. IC 501 is a \*J-K Flip Flop integrated circuit. The collector supply voltage for the IC and Q516 is a result of the action of D12, a 5 volt Zener diode.

The output from IC 501, pin 8, is coupled to a waveshaping network and to the out put pin 14.



\*J-K Flip Flop – IC 510 is a single package two stage bi-stable divider. Failure of one stage requires the replacement of the IC package. Several pins of the IC package are not used in this circuit application.

**2-30. NORMAL PERCUSSION KEYING.** – In the normal percussion mode, when a key is depressed on the upper manual, 220K ohms of resistance are connected between pin 15 and ground. As a result, the positive voltage at pin 15 is reduced. This negative change is differentiated by C517 and applied to the base of Q512 (normally on). The resulting positive pulse at Q512 collector is coupled to Q513, turning it on. The negative change, at the collector of Q513, is coupled by C510, forward biasing D509 and D510. C511 is also charged. Since the pulse used to charge C511 is momentary, C511 begins to discharge immediately.

With the Guitar and Chimes switch in the off position, pin 10 is grounded. The discharge path of C511 is split. One path is through D510, R537, and the combination of Q510 and Q511. The other is through D511 and R546 to ground. This provides for the short decay time. When either the Chimes or Guitar switch is depressed, the ground is removed from pin 10 and the second discharge path is opened. The result is a longer decay time.

The entire action will be rekeyed when an additional key is depressed. The voltage at the input will drop in increments with each key depressed and result in an output pulse fed to Q510 and Q511. This type of keying is referred to as Legato type percussion.

**2-31. REITERATION KEYING AND TRIGGERING.** – When the reiteration tab is depressed, the percussion keying busbar in the upper manual is connected to pin 2. With normal percussion, it was connected to pin 15.

When an upper manual key is depressed, a 220K resistor connects pin 2 to ground. This causes the base of transistor Q501 (normally off) to drop from +23 volts to approximately +22.5 volts which causes it to conduct. The collector of Q501 rises to +23 volts. The +23 volts is routed to pin 4, which is connected to the reiteration rate control on the control panel, and also to the top of R506.

From Pin 4, through to the wiper of the reiteration control, which is connected to pin 18, the voltage is fed to R508 and R509. The

varying voltage applied to pin 18 causes the astable multivibrator (Q506 and Q507) to vary in frequency.

The positive 23 volts applied to R506 causes D502 to be forward biased. This action brings the junction of R506 and D502 to a positive 15 volt level. This 15 volts causes D503 to be forward biased and subsequently becomes the supply voltage.

The outputs are taken alternately from the bases of the multivibrator transistors. The negative pulses drive the main and alternate gate circuits.

**2-32. MAIN AND ALTERNATE CHANNEL GATES.** – The main channel gate circuit consists of transistors Q508, Q509, Q510, Q511.

As Q506 and Q507 (multivibrator transistors) conduct alternately, pulses from the base of Q507 are supplied to the emitter of Q511, the gating transistor, and Q510, a grounded base amplifier. The AC signal on the base of Q511 is insufficient for Q511 to conduct. The pulses from the base of Q507 supply sufficient bias to cause conduction of Q511.

Through Q511, two signal paths exist, one for the gating signal and one for the music signal. The usable portion of the music signal passes through the base-collector junction of Q511, through R556 (Main Null Control), to the base of Q509. The music signal is amplified by Q509 and controlled as to amount of output by the setting of R557 (Percussion Level Control).

The gating signal, as was mentioned previously, is applied to the emitters of Q510 and Q511. The signal which goes through Q511 appears at the collector with the music signal and is applied to the base of Q509. The gating signal also appears at the collector of Q510 and is directly coupled to the base of Q508. From the emitter of Q508, the signal is coupled to the emitter of Q509. The signal from the emitter of Q509 appears at the collector out of phase with the signal impressed on its base. As a result, the two gating signals are out of phase and cancellation takes place. The Main Null Control (R556) is to affect maximum cancellation of the gating pulses.

The operation of the alternate channel gate is identical as that described for the main channel.

Of special note is that R557 (Percussion Level Control) is the common collector load for both Q502 and Q509. As a result, the gain of both gates is controlled by R557.

**2-33. PERCUSSION SETUP PROCEDURE.** – Equipment needed:

1. Tektronics oscilloscope 503 or equivalent.

Depress the "REITERATE" tab and set Reiterate Rate control at approximately mid position.

Depress and hold key #25. Rotate the Percussion control R557 full counter clockwise up. Refer to Figure 5-37 for following setup procedure.

Connect the oscilloscope to the junction of C503 and R527 on Percussion Board. Set the oscilloscope sensitivity to 10 mv/cm and rotate the Alternate Null R519 and Main Null R556 controls until the pulses on the oscilloscope are adjusted to minimum amplitude. Observe Figure 2-5 for proper waveshape.

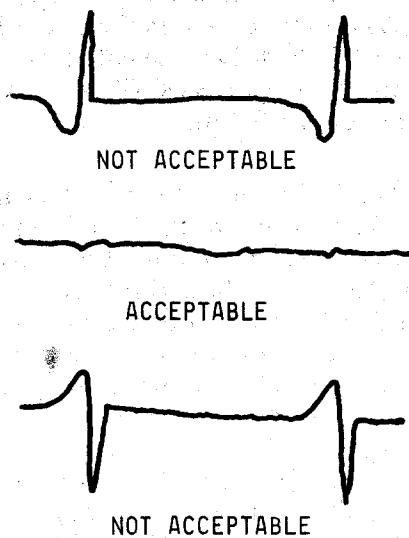

Figure 2-5

**PERCUSSION AND REITERATION GAIN**  
Depress "CELESTA" tab, depress "REITERATE" tab and place control in approximate mid position. Connect the oscilloscope to the "S" speaker terminal and adjust vertical sensitivity to 1.0 V/cm. Depress and hold upper manual key #25.

Adjust the Percussion Level control (R557) until the percussion output is 10.5V ± .3V Peak to Peak.

Return all tabs to their "off" position. Depress CHIMES or GUITAR tab. Depress key #25. And

hold Decay time should be approximately three seconds. All other percussion voices should have a decay time of approximately one-half to one second.

**REITERATE RATE ADJUSTMENT.** Depress CELESTA and REITERATE tabs. Adjust the Reiterate Rate control to maximum (full clockwise). Hold down upper manual key #25 and measure the duration of one complete percussion wave form on oscilloscope. It should be between 45 and 65 milliseconds (Figure 2-6). Reset the oscilloscope.

Horizontal Sweep .1 sec/cm. Adjust the Reiteration Rate control to minimum (full counter-clockwise). Hold down upper manual key #25 and measure the duration of one complete percussion waveform on the oscilloscope. It should be between .10 and .45 seconds. Turn off REITERATION tab.

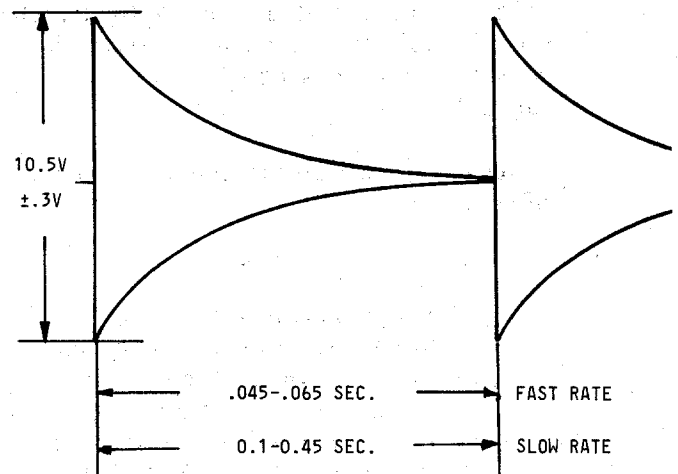

Figure 2-6

**PERCUSSION PRESET VOICES.** To check voicing of percussion, it is necessary to match the upper manual percussion voice with a lower manual Tonebar registration by playing a chord in short staccato fashion on the upper manual, and then playing the same chord, in the same staccato manner, on the lower manual.

Note that the output for percussion voices on the upper manual will be slightly higher than the corresponding Tonebar registration output of the lower manual.

Tonebars that are registered will be set at position #8.

Clear all tonebar registrations and depress "CELESTA" and "TONEBARS" (lower) tabs.

VOICE	TONEBARS						
	1	2	3	4	5	6	7
CELESTE	0	8	0	0	0	0	0
*CHIMES	0	8	8	8	0	0	0
GUITAR	8	8	8	8	0	0	0
MARIMBA	8	0	0	8	0	0	0
XYLOPHONE	0	8	0	0	0	8	0
BANJO	0	8	8	8	8	8	0

**\*NOTE**

There will be a mismatch in chimes. The 1¼ harmonic present in the upper manual chimes voice is not available in the lower manual Tonebar registration. By disconnecting the orange lead at pin #14 (1¼ harmonic output) on the Percussion Board.(124-000170), a perfect match should be obtained.

**2-34. ROTARY TREMOLO UNIT (121-000132).** - This Tremolo unit is located in one of the Satellite speaker cabinets. Connection to the main console is accomplished with a seven conductor cable.

Refer to Figure 5-36 for schematic diagram of circuitry.

**NOTE**

The voltages mentioned in the following description are measured with respect to Pin 6. However, it is extremely important to note that **UNDER NO CONDITION SHOULD PIN NUMBER 6 BE CONNECTED TO THE COMMON CONSOLE GROUND SYSTEM.**

This unit receives 120VAC from the console when the console on-off switch is turned "ON". A transformer is used to obtain 100 volts A.C. for the organs that are designed for 220 Volt A.C. operation. The input A.C is applied to pins 1 and 2 of the six-pin connector. The audio signal is applied directly to speaker commutators.

One side of the A.C. input (Pin-1) is connected to Diode D1. This voltage is rectified by D1 and fed to the voltage divider network consisting of R1, R3, R4, R15, R16, and filter capacitor C1. The +12 V.D.C., developed at the junction of R1 and R15, is used to supply transistors Q1 and Q2. The Zener diode D4 at

the junction of R15 and R3 provides the +6 VDC reference voltage for the FAST and SLOW speed switch.

A.C. supply input (Pin-1) is also connected through the motor winding to one side of bridge consisting of diodes D6 to D9. The bridge is also connected in series with transistors Q3 and Q4. The other side of the AC supply (Pin-2) is connected to the bridge at the junction of D8 and D9. The bridge acts as a full wave rectifier and supplies pulsating D.C. for the motor and for transistors Q3 and Q4.

If the unit is NOT rotating the base of amplifier Q1 is about .4VDC and its collectors is .8VDC. This D.C. level is fed to the base of Q2 and as a result, Q2 is turned fully "ON", and its collector is less than .1VDC. This .1VDC is fed to the base of Q4, and with these conditions Q3, Q4 (a stacked transistor stage) are turned off. As previously stated Q3 and Q4 are connected in series with the bridge, motor, and A.C. supply. Q3 and Q4 act essentially as an open circuit and thus most of the pulsating D.C. supplied by the bridge (D6 to D9) is dropped across these transistors. For the stated conditions the collector of Q3 is at approximately 150VDC (Pulsating) and the motor does NOT turn.

In the XTP, the Tremolo unit is always allowed to run at slow speed. For this condition Pin 4 is connected to Pin 5 and Pin 4 provides approximately 2VDC bias to the junction of D2 and R5 which are part of the speed sensor bridge. The output of the speed sensor is connected to the junction of D2 and D3. The resulting output of the bridge is connected through R7 to the base of amplifier Q1. In the slow mode of operation, the base of Q1 varies in a pulsating manner (due to the speed sensor) from .7 Volts to .9 Volts. The collector of Q1 changes at the same rate (.6 to .7V) and this pulsating change is fed to base of amplifier Q2. The collector of Q2 changes from .5 to .7V at the same pulsating rate, and this signal is fed to the base of Q4. This causes Q3, Q4 stacked transistor stage to conduct harder (more) as the base of Q4 rises to its positive peaks (.7) and less when its base is at the .4 volt level. Q3, Q4 conduct enough so that the collector voltage of Q3 (this is the amount dropped across these transistors) drops to about 100VDC (Pulsating). This allows more voltage to be supplied to the motor and the motor turns at its slow rate. At both the fast and slow rates the sensor bridge provides the necessary feedback to the base



of Q1 so as to maintain the desired speed accurately.

For fast operation Pin-5 is connected to pin 3, which applies the 6VDC (Zener supply) to the speed sensor bridge. Initially, when switching from slow to fast speed, the base of Q1 rises to approximately 1 Volt which turns Q1 on harder and its collector voltage reduces to .4V which is fed to base of Q2. Q2 turns off and its collector voltage rises to approximately 1 Volt and this 1 Volt is fed to the base of Q4. The stacked transistor stage of Q3, Q4 turns fully "ON" and very little pulsating D.C. is now dropped across Q3, Q4. Maximum pulsating D.C. is then applied to the motor and its speed rises rapidly to its maximum level.

As the motor speed is rising, the speed sensor is increasing the feedback voltage applied to the speed sensor bridge. As the fast speed is obtained the base voltage of Q1 decreases to approximately .9VDC and the collector of Q1 stays at about .7VDC. The .7VDC level is fed to the base of Q2 and the collector Q2 stays at about .65VDC. The collector voltage of Q2 is fed to the base of Q4. Q3, Q4 transistor stage is turned "ON", not fully on, but enough so that the voltage dropped across Q3, Q4 is maintained at about 75 VDC (Pulsating). This allows a larger amount of voltage to be supplied to the motor and it maintains its "FAST" speed.

When servicing one of these tremolo units, DO NOT under any circumstances connect Pin 6 to the console ground system or home wiring ground system as this will seriously damage the unit.

- 2-35 HUM.** – Hum reading should be taken with the control panel cover shield, music lamp, and pedal lamp installed and "TREMOLLO" tablet in SLOW position.

Depress the following tabs: TONEBARS and PERCUSSION and BRILLIANCE. Turn on Music Lamp and Pedal Lamp. Turn the 6-Voice Rhythm volume control to maximum. Hum level should be less than .060 Volts RMS. Depress the REVERB I and II tabs. Hum level should be less than .070 Volts RMS.

- 2-36 TONE CABINET OUTLET BOX.** – The XTP is wired for connection to two Satellite speaker cabinets. It also has a nine (9) pin plug which

allows connection direct to a Model 700 Leslie speaker.

The outlet box has three plug outlets:

1. Phono Plug for Main Speaker (Hammond)
2. 7 Pin for Tremolo Speaker (Hammond)
3. 9 Pin for Model 700 Speaker (Leslie)

#### NOTE

For earphones, refer to paragraph 2-26.

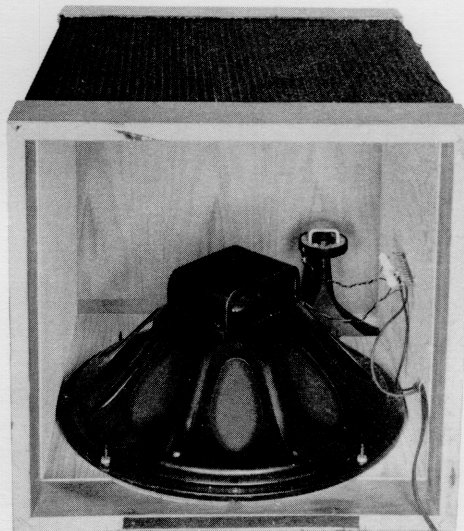

Main Speaker Cabinet  
Fig. 2-7

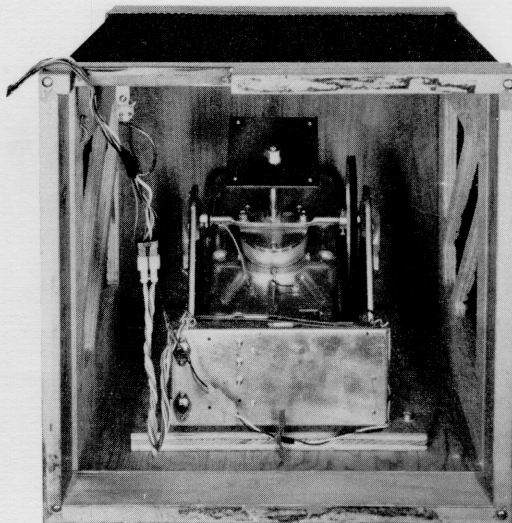

Rotary Tremolo Speaker Cabinet  
Fig. 2-8



keyer boards (six from end board, four from center board).

- (c) Remove the two mounting bolts which go through the lower cabinet cross member and into the Pedal Switch Base.
- (d) Tilt Pedal Switch end of organ approximately 12 inches and block.
- (e) Remove the four mounting bolts which come up through the bottom of the cabinet into the Pedal Switch Base, (two on each end).

## XTP

**3-14 TOP PANEL ASSEMBLY.** – Lift front of assembly vertically until two latching pins are disengaged from top of the control panel. Slide top Panel Assembly forward 2 to 4 inches to free rear catches. Disconnect two plugs, one to the rhythm unit and one to the music light. Lift Top Panel Assembly free of console.

**3-15. UPPER CONSOLE WOODWORK.** – Locate five Phillips head woodscrews at right side of console as viewed from bottom of upper console assembly. Remove center three as illustrated in Figure 3-1. Remove lower manual cover which contains the pedal light and headphone jack by removing four Phillips head machine screws. Care must be taken not

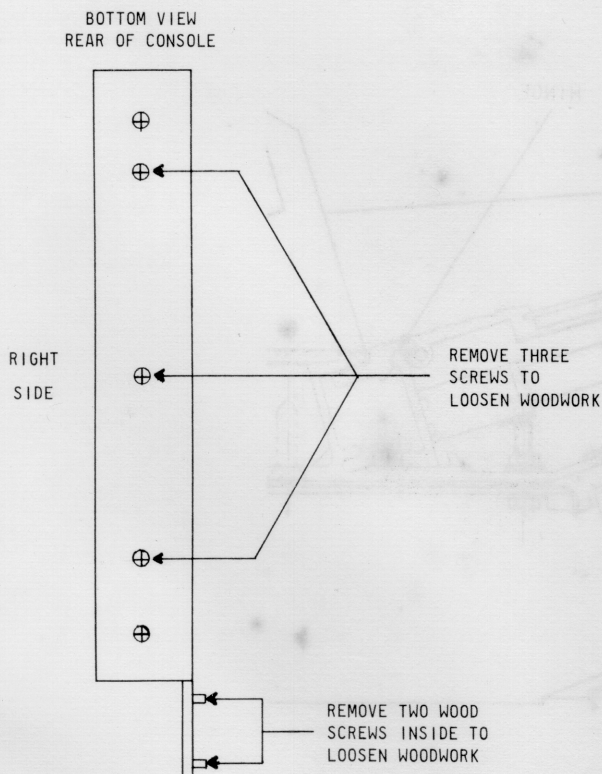

Fig. 3-1

to break the connections to the phone jack when cover is freed from console. Inside below the lower manual right end block, remove two slotted hex head woodscrews as illustrated in Figure 3-1.

Follow the above directions in locating and removing the same number of screws on the left side of console.

Locate and remove two slotted hex head woodscrews from vibrato line assembly support brackets, as illustrated in Figure 3-2.

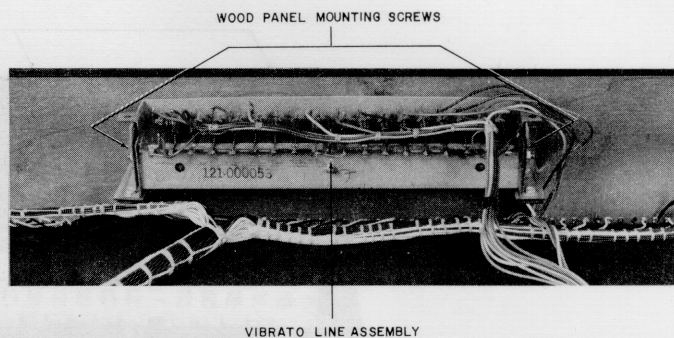

Fig. 3-2

Loose woodwork can now be removed.

**3-16. PEDAL BASE TOP COVER.** – Remove one screw from each side of the lower front outside corners of the Pedal Base Top Cover Assembly. Slide cover forward and lift up only enough to clear sharp pedal keys until assembly is free of console.

When reassembling the Pedal Base Top Cover, several hold down clips mounted on the inside at the rear of the assembly must be hooked under the rear frame lip.

**3-17. PEDESTAL WOODWORK.** – Under normal servicing this woodwork should never need to be removed. In the event that it becomes necessary, new parts must be ordered as they will be destroyed in removal.

Remove metal trim plate from front of pedestal woodwork by inserting some tool behind trim and prying until contact cement is separated from wood panel. Remove four Phillips head woodscrews and withdraw front panel. The rest of the woodwork is one assembly and can be carefully removed from the rear of the organ.



Trim plate and Logo will have to be replaced if trim plate is damaged.

**3-18. BASE REAR COVER.** — Six screws are used to mount the Base Rear Cover. The top three can be removed from the inside of the base assembly. The bottom three can be reached through three round access holes in the top of the Base Rear Cover as illustrated in Figure 3-3.

**3-19 MUSIC LIGHT ASSEMBLY.** — When it becomes necessary to replace one or more of the 17 incandescent bulbs in the Music Light Assembly,

1. Remove 4 screws (Phillips head) beneath light assembly (Figure 3-4).
2. Swing upper portion of assembly up on hinge (Figure 3-4).
3. Replace bulb (s) and reassemble.

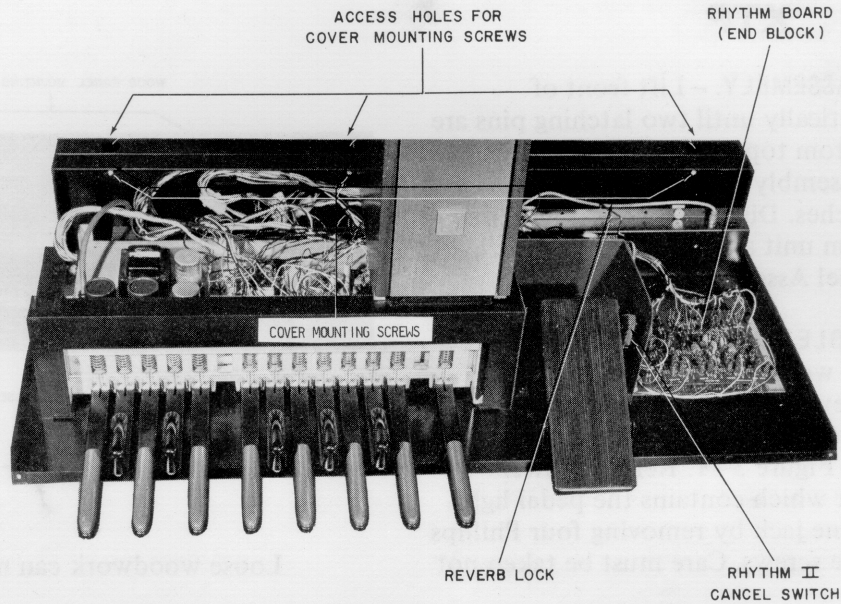

Fig. 3-3

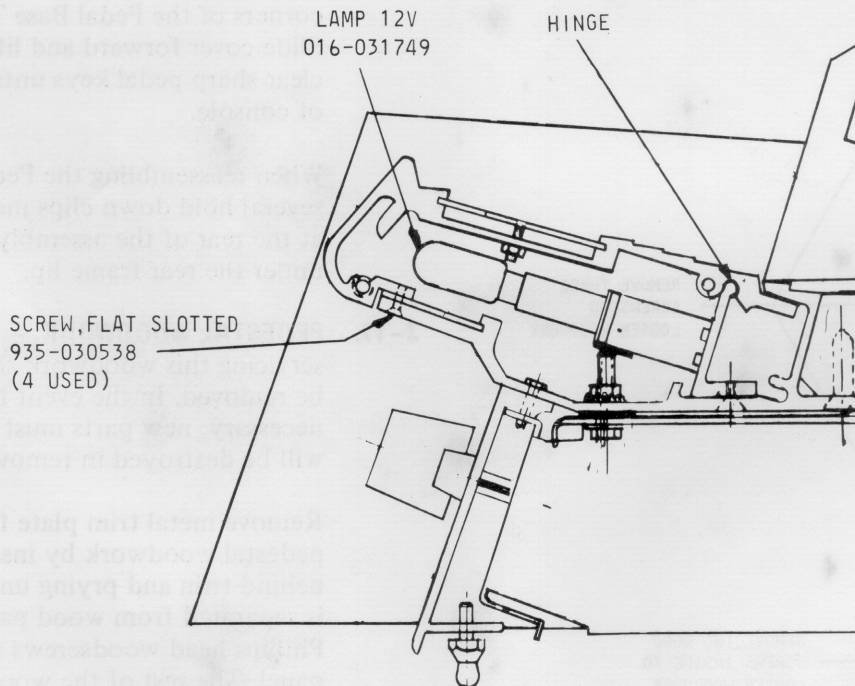

Fig. 3-4

### NOTE

The 14" length should be increased to 15 $\frac{3}{4}$ " for T-222. In addition to the spacer strip, 6 glides are required which will be supplied on a no-charge basis. Order Part No. 032-041468 Plastic Glide.

**GLIDER/SPACER INSTALLATION INSTRUCTIONS.** — Be careful not to disrupt generator mounting or other electrical components. Proceed according to the following:

1. Remove and set aside the metal glides from console.
2. Securely glue and nail spacer strip to underside of each end of cabinet and remount (4) metal glides to spacer strips, approximately 1 inch from each end.
3. Insert (2) plastic glides into legs. (Care must be taken not to split leg).
4. Remove (4) metal glides on bench and install the (4) remaining glides. This completes installation. See Figure 4-7.

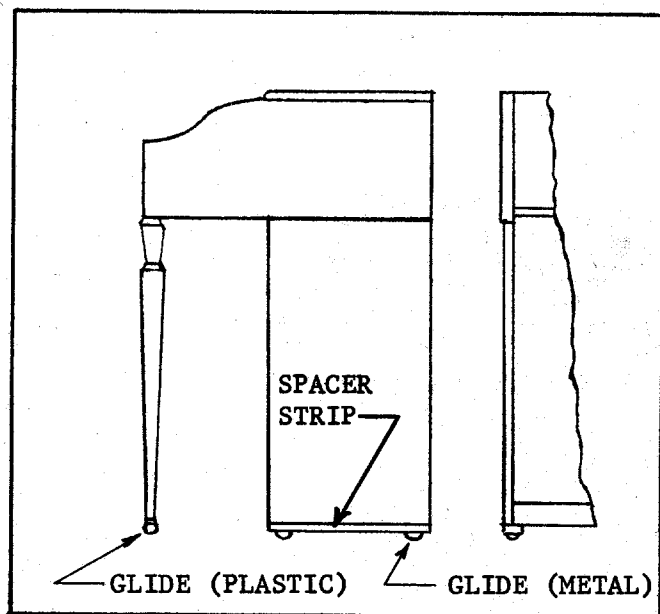

Figure 4-7. Placement of Glides

**4-12. ADJUSTMENT AND TROUBLE ANALYSIS, SIX-VOICE RHYTHM, T-200-1, T-200-2, T-400**

**4-13. OUTPUT LEVEL ADJUSTMENTS.** — The rhythm volume levels are set at the factory, and will normally require no adjustment. In case it is found necessary to

replace a part on the rhythm board, 124-000114, adjustment will be required. To adjust output levels, proceed according to the following. A VTVM, Amphenol Millivolt Commander, Model 870, or equivalent is required. See Figures 5-20 through 5-22 for locations of controls.

- a. Set all tabs and rocker switches to "up" or "off" positions. Set swell pedal and RHYTHM VOLUME control to maximum output.
- b. Connect VTVM across main speaker leads.
- c. Press CYMBAL push button at about 5 times per second. Adjust R113 to obtain a meter indication of 2.2 to 2.8V rms.
- d. Press BRUSH push button at about 5 times per second. Adjust R126 to obtain a meter indication of 2.2 to 2.8V rms.
- e. Press TOM-TOM push button at about 5 times per second. Adjust R134 to obtain a meter indication of 1.3 to 1.7V rms.

**4-14. ONE RHYTHM VOICE IS SILENT.** — Check the following:

- a. Connection to corresponding pin of rhythm PWB, 124-000114, See Figures 5-20 through 5-22.
- b. If connections O.K., check for +15V DC at pin when push button of missing voice is held down.
- c. If voltage is missing, check connections to push button switch, rocker tab, and organ power supply.
- d. If voltage is present, trace associated voice circuitry.

### NOTE

If failure is in Brush and/or Cymbal voice, check Q101.

**4-15. PROGRAMMED VOICE DOES NOT SPEAK.** — If any voice speaks when push button is pressed, but not from programmed source (manual or pedal, as applicable), check rocker switch and associated wiring. See Paragraphs 4-18 and 4-19 also.

**4-16. ALL PERCUSSION VOICES SILENT.** — (Hiss voices speak.) — Check Q107, Q108, and associated circuitry.

**4-17. BOTH HISS VOICES SILENT.** — (Percussion voices speak.) — Check Q106 and associated circuitry. Check Q101.

4-18. **NO RHYTHM VOICE RESPONSE FROM PEDALS.** – Check pedal keying pulse circuits. Paragraph 2-25.

4-19. **NO RHYTHM VOICE RESPONSE FROM MANUAL.** – Check manual keying pulse circuits. Paragraph 2-24.

4-20. **RHYTHM RAIL ADJUSTMENTS (See Figure 5-18.)** – The potentiometers on the Voice Board and Detector Board are set at the factory, and normally require no adjustment. If either board has been repaired or replaced make the adjustments described below. Set up the following conditions before making adjustments.

Swell pedal to full output

All Rhythm Rail slide switches OFF

Rhythm Rail VOLUME slide switch in LOUD position

A. Connect AC VTVM across stationary speakers. Depress CYMBAL push button at about 5

times per second. Adjust R490 for average output of 2.5 volts.

B. Depress BRUSH push button at about 5 times per second, and adjust R491 for average output of 2.5 volts.

C. Connect AC VTVM to pins 16 and 19 of Voice Board 124-000023. Press and hold down DRUM ROLL push button. Adjust R201 for an output of approximately 700 mv.

4-21. **OVERALL ORGAN LEVEL ADJUSTMENT.** – Recovery and non-vibrato board 124-000014 incorporates an overall volume level adjustment, set at the factory. If it becomes necessary, it can be readjusted by attaching a VTVM to the voice coil of either stationary speaker, pulling 8' drawbar on either manual to #8, playing Lowest C on manual (Frequency 37), and adjusting the output to 1.4V. R.M.S. with the "Swell" pedal fully depressed.

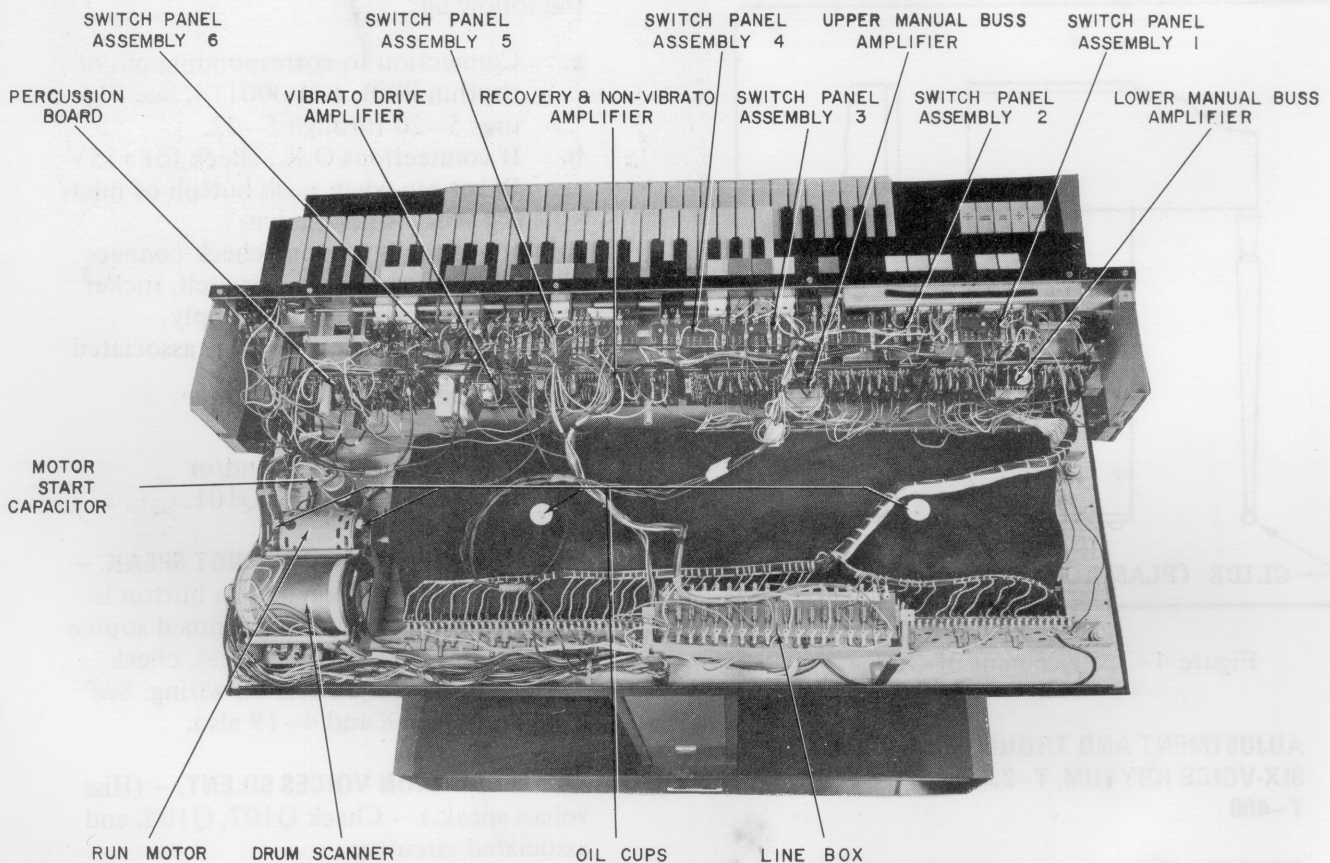

Upper Console Components Location  
Figure 4-8



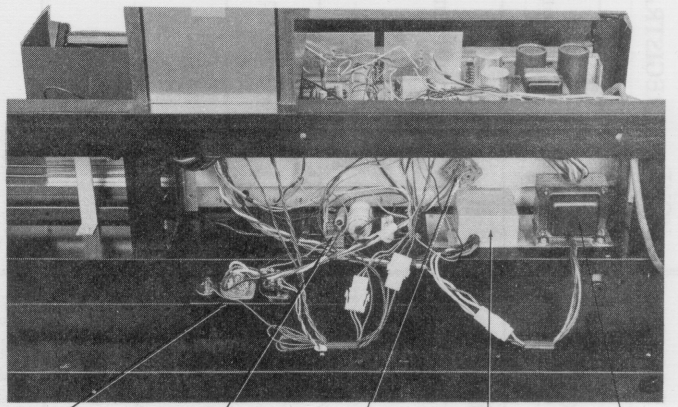

OUTLET BOX      CROSSOVER NETWORK      TONE CABINET PLUG      TERMINAL BOX      MUSIC LIGHT TRANSFORMER

Lower Console Components Location  
Figure 4-9

TABLE 4-1. ALIGNMENT & PERFORMANCE CHECK, "T" SERIES

STEP	MODEL	TEST POINT	DEPRESS TAB OR ROCKER	DRAWBAR REGISTRATION	PLAY KEY(S)	ADJUST	OSCILLOSCOPE OR OTHER INDICATION
1. a.	All	Across main speaker	DRAWBARS & PERCUSSION	Upper Manual 8' Drawbar to position 8	#25 Upper Manual	R870 on 124-000014	4.0V P-P
b.	All	Across main speaker	DRAWBARS & PERCUSSION, VIBRATO ON	Upper Manual 8' Drawbar to position 8	#25 Upper Manual	Early production none	3.2V to 5.0V P-P
2.	All	Across main speaker	DRAWBARS L/M	Lower Manual 8' Drawbar to position 8	#25 Lower Manual	None	4.1V±0.9V P-P
3.	All	Across main speaker	16'8" Rocker 16' position	16'8" Drawbar to position 8	Pedal #1 (Low "C")	None	18.5V±4.5V P-P
4. a.	Except 262	Across main speaker	CELESTA REITERATION	NONE	#25	R356 on 008-035130	.5V to .6V P-P @ Tail Off
b.(1)	Except 262	Across main speaker	MARIMBA REITERATION	NONE	#25	R545 on 124-000181	5V P-P
(2)						R539 on 124-000181	5V P-P
(3)						R530 on 124-000181	Alternate channel signal is at midpoint between main channel signals
c.	Except 262	Across main speaker	MARIMBA & BANJO	NONE	Chord (2 or more keys)	R551 on 124-000181	Inaudible
d.	262 only	Across main speaker	HARP	NONE	#25	R356 on 008-035130	.3V to .5V P-P @ Tail off
e.	262 only	Across main speaker	HARP	NONE	#25	R551 on 124-000113	Inaudible
f.	262 only	Across main speaker	HARP	NONE	#25	R545 on 124-000113	5V P-P
g.	262 only	Across main speaker	HARP CELESTA	NONE	Chord (2 or more keys)	R551 on 124-000113	Inaudible
5. a.	100 200	Across main speaker	BRUSH/LOWER	NONE	Any 3 keys Lower Manual repeatedly	BRUSH LEVEL R906 on 124-	3V RMS

					Lower manual repeatedly	LEVEL R906 on 124-000020	
b.	100 200	Across main speaker	CYMBAL/PEDAL	NONE	Any pedal repeatedly	CYMBAL LEVEL R917 on 124-000020	3V RMS
c.	100 200	Across main speaker	CYMBAL/PEDAL	NONE	Hold down any pedal	CYMBAL SYSTAIN R913 on 124-000020	Just inaudible
d.	300 only	Across main speaker	CYMBAL Push Button-5 times/second	NONE	NONE	CYMBAL LEVEL R490 on 124-000024	2.2V to 2.8V RMS
e.	300 only	Across main speaker	BRUSH push Button-5 times/second	NONE	NONE	BRUSH LEVEL R491 on 124-000024	2.2V to 2.8V RMS
f.	300 only	Pins #16 & #19 Voicing Board. 124-000023	DRUM ROLL Push Button	NONE	NONE	R201 on 124-000023	2.0V±0.2V P-P
g.	200-1 & 2, 400	Across main speaker	CYMBAL Push Button-5 times/second	NONE	NONE	R113 on 124-000114	2.2V to 2.8V RMS
h.	200-1 & 2, 400	Across main speaker	BRUSH Push Button-5 times/second	NONE	NONE	R126 on 124-000114	2.2V to 2.8V RMS
i	200-1 & 2, 400	Across main speaker	TOM-TOM Push Button-5 times/second	NONE	NONE	R134 on 124-000114	1.3V to 1.7V RMS
6. a.	100 200 262	Across main speaker		NONE	NONE	NONE	Less than .050V RMS (Hum Level)
b.	100 200 262	Across main speaker	REVERB I & II	NONE	NONE	NONE	Less than .055V RMS (Hum Level)
c.	300 200-1 & 2, 400	Across main speaker		NONE	NONE	NONE	Less than .060V RMS (Hum Level)
d.	300 200-1 & 2, 400	Across main speaker	REVERB I & II	NONE	NONE	NONE	Less than .070V RMS (Hum Level)

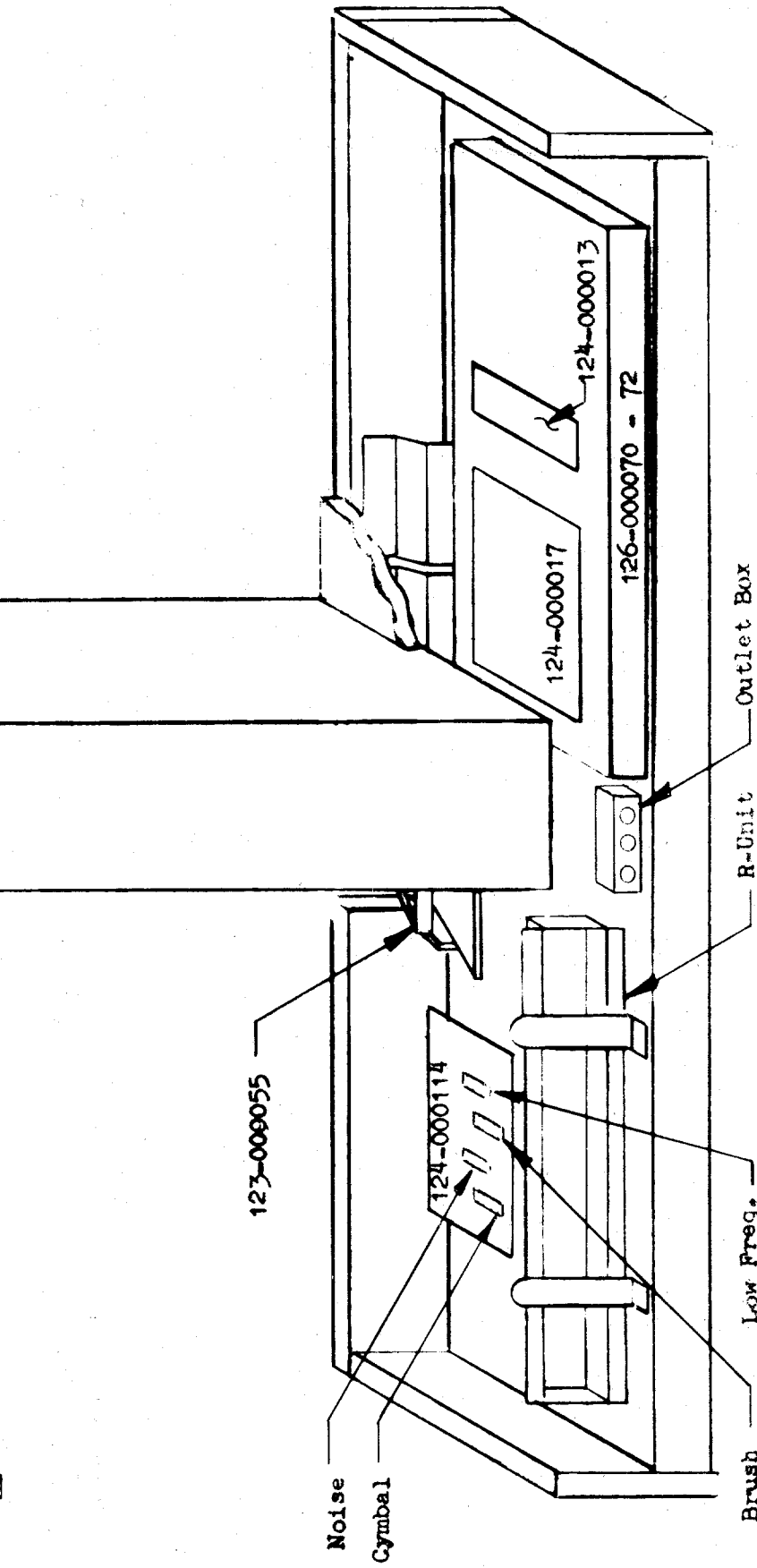
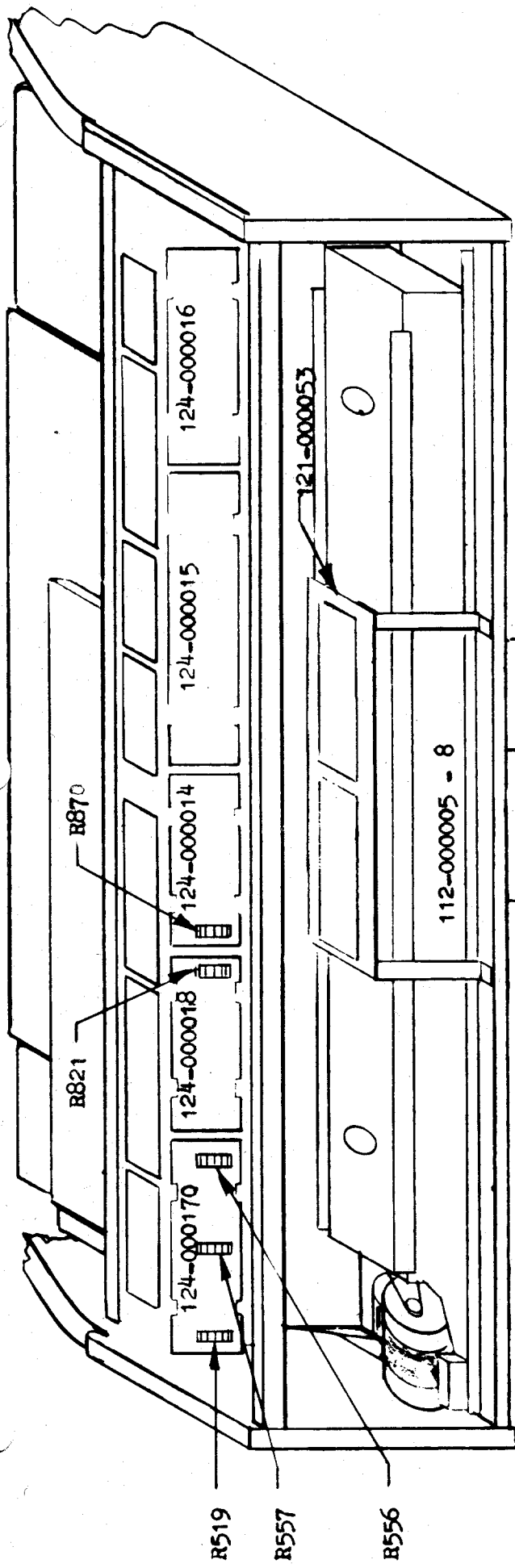
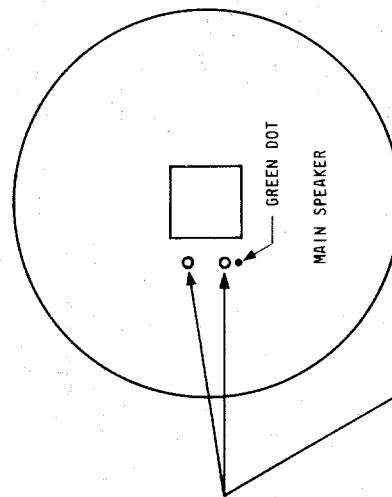
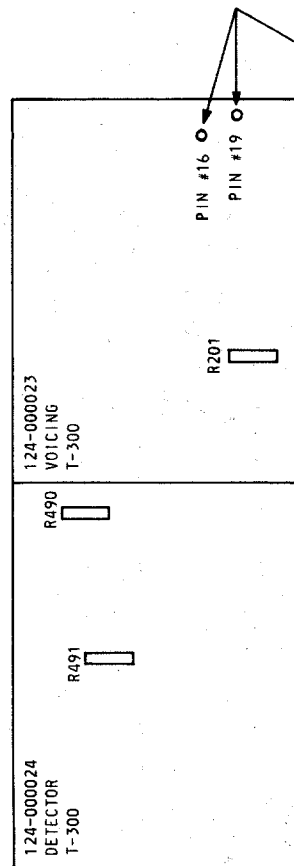
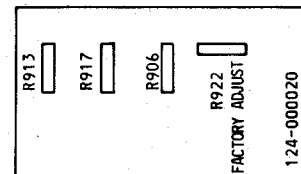
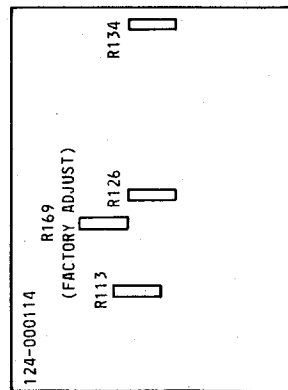
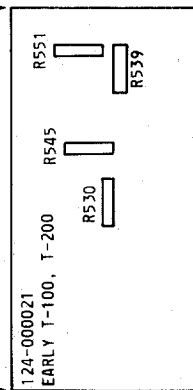
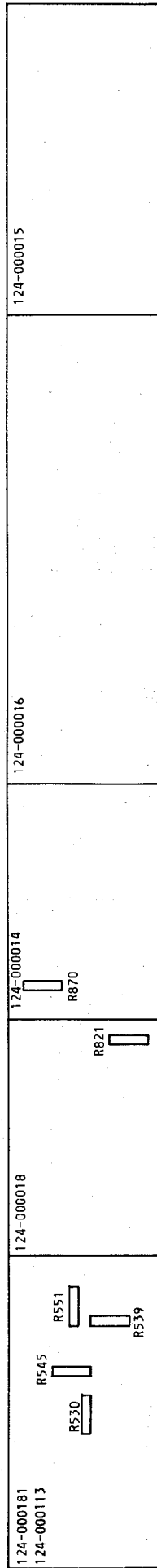
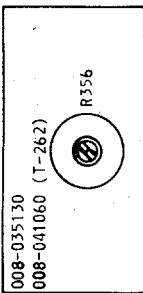



TABLE 4-2. ALIGNMENT & PERFORMANCE CHECK, XTP

STEP	TEST POINT	DEPRESS TAB OR ROCKER	TO NEBAR REGISTRATION	PLAY KEY (S)	ADJUST	OSCILLOSCOPE OTHER INDICATION
1	Outlet Box Phono Plug	TONEBARS & PERCUSSION tab	Upper Manual 8' Tonebar to Position 8	#25 Upper Manual	R870 on 124-000014	5.5V P-P
2	Outlet Box Phono Plug	TONEBARS tab	Lower Manual 8' Tonebar to Position 8	#25 Lower Manual	None	5.6 ± 1.4V P-P
3	Outlet Box Phono Plug	16'8" Rocker 8' Position	16'8" Tonebar to Position 8	Pedal #1 (Low "C")	None	36V ± 9V P-P
4	Outlet Box Phono Plug	REITERATE	Reiteration rate-midpoint Percussion level-R557 (full) counterclockwise.	#25 Upper Manual	Alternate Null R519 & Main Null R556 Alter- nately	Ticking from speaker is minimized (Nullled)
5	Outlet Box Phono Plug	CELESTA, REITERATE	None	#25 Upper Manual	Percussion Level-R557	10.5V P-P
6	Outlet Box Phono Plug	MARIMBA, REITERATE	None	#25 Upper Manual	None	High Frequency 7.3V ± 2.8 P-P Low Frequency 5.4V ± 1.9V P-P
7	Outlet Box Phono Plug	TONEBAR & PERCUSSION tab. VIBRATO ON/UPPER tab.	Upper Manual 8' Tonebar to Position 8	#25 Upper Manual	R821	4.0V P-P
8	Outlet Box Phono Plug	TONEBARS tab. VIBRATO ON/LOWER tab.	Lower Manual 8' Tonebar to Position 8	#25 Lower Manual	None	5.5 ± 1.1V P-P
9	Outlet Box Phono Plug	TREMOLO, in slow. TONEBARS & PERCUSSION, BRILLIANCE Music Lamp Pedal Lamp 6-Voice Rhythm Control Max. Add REVERB I & II	None	None	None	Hum less than .060 Volts RMS
			None	None	None	Hum less than .070 Volts RMS



TEST POINTS

TEST POINTS

TEST POINT AND ADJUSTMENT LOCATIONS FOR TABLE 4-1

## **SECTION V DIAGRAMS**

- 5-1. GENERAL.** – This section contains diagrams which illustrate the foregoing text and provide information necessary to proper organ servicing.
- 5-2. ARRANGEMENT OF SECTION.** – Schematic diagrams illustrating the latest production are shown in Figures 5-1 through 5-22. Wiring diagrams for both early and late production are shown in Figures 5-23 through 5-30. Schematic diagrams for early T-100 and T-200 models are shown in Figures 5-31 and 5-32. Figure 5-33 is T-262 schematic diagram.

### **XTP**

Wiring and schematic diagrams for the XTP are shown in Figures 5-34 thru 5-41.



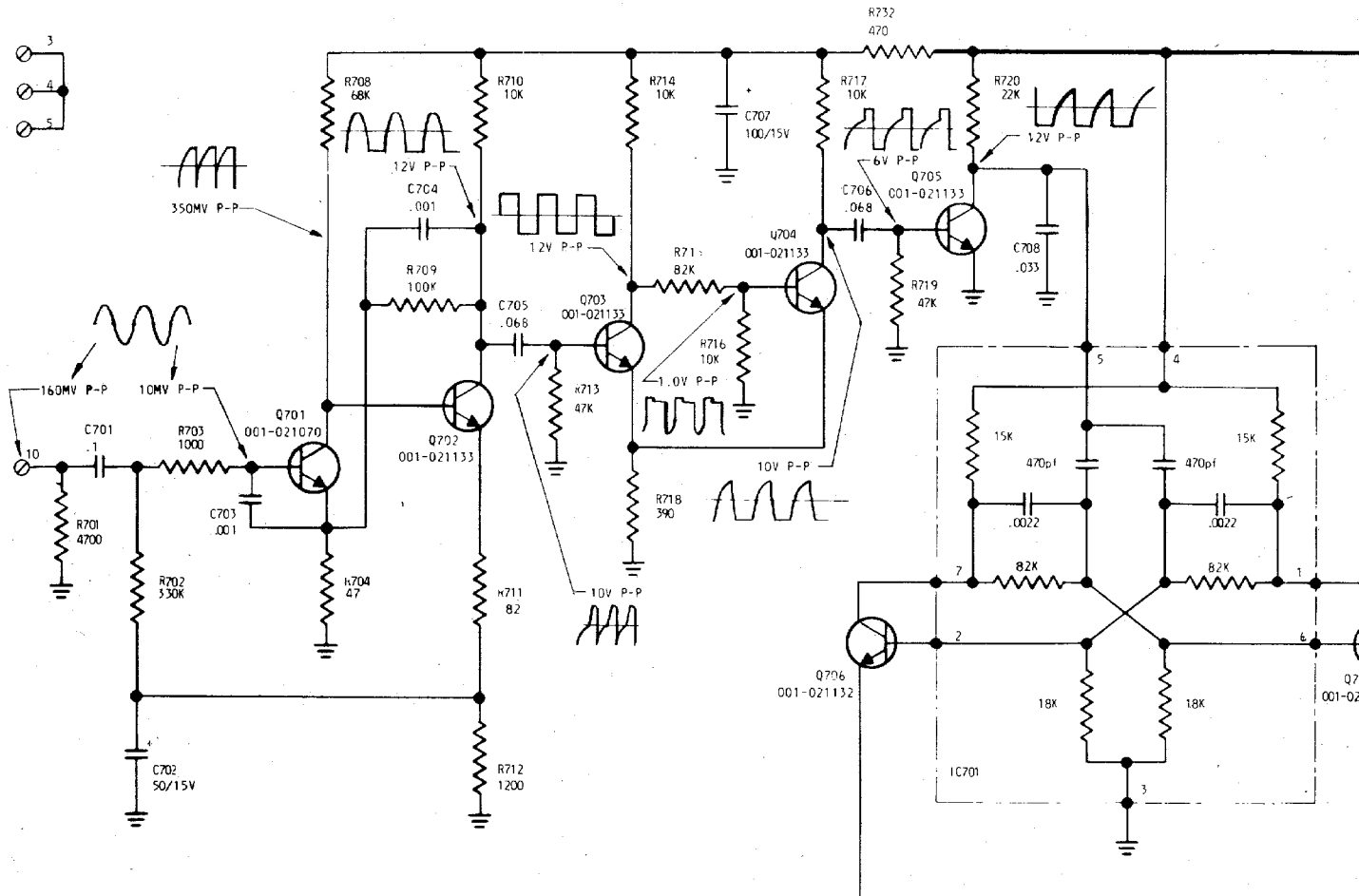

NOTES:

1. SYMBOL: TERMINAL ON PRINTED WIRING BOARD.
2. UNLESS OTHERWISE SPECIFIED:  
ALL RESISTORS ARE IN OHMS, ± 10%, 1/2 WATT;  
ALL CAPACITORS ARE IN MICROFARADS.
3. WAVEFORMS P-P INDICATIONS OBTAINED WITH LOW "C" PEDAL DEPRESSED.

094-035052-6J

FIGURE 5-1.  
LAYOUT AND SCHEMATIC DIAGRAM  
PEDAL DIVIDER BOARD,  
124-000013

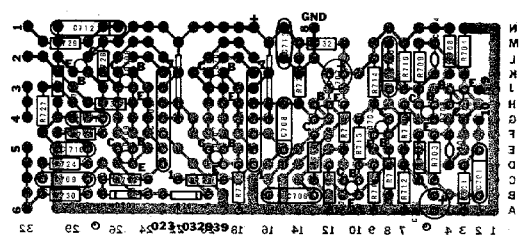
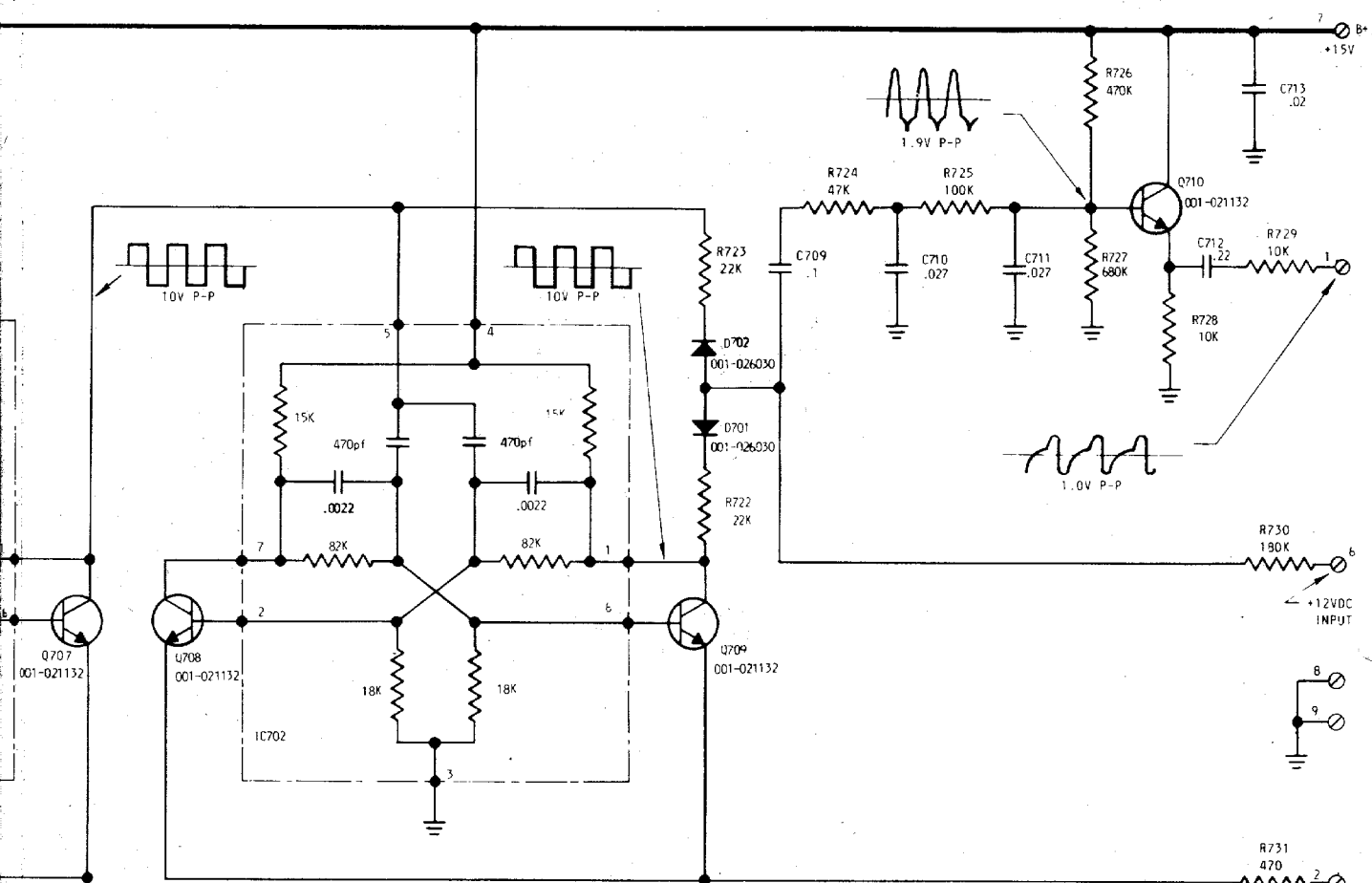



NOTES:

1. COMPONENTS NO. 100 THRU 199 ARE LOCATED ON LOWER MANUAL BUS AMPLIFIER.
2. COMPONENTS NO. 200 THRU 299 ARE LOCATED ON UPPER MANUAL BUS AMPLIFIER.
3. COMPONENTS NO. 300 THRU 399 ARE LOCATED ON CONTROL ASSEMBLY.
4. COMPONENTS NO. 400 THRU 499 ARE LOCATED ON EXPRESSION CONTROL, END BL...
5. COMPONENTS NO. 500 THRU 599 ARE LOCATED ON PERCUSSION BOARD.
6. COMPONENTS NO. 600 THRU 699 ARE LOCATED ON AMPLIFIER & POWER SUPPLY CA...
7. COMPONENTS NO. 700 THRU 799 ARE LOCATED ON PEDAL SWITCHBOARDS & PEDAL...
8. COMPONENTS NO. 800 THRU 899 ARE LOCATED ON RECOVERY & NON-VIBRATO BOAR...
9. UNLESS OTHERWISE SPECIFIED:
  - (a) ALL RESISTANCE VALUES IN OHMS,  $\pm 10\%$
  - (b) ALL RESISTORS 1/2 WATT
  - (c) ALL CAPACITORS WITH DECIMAL VALUES IN MFD.
10. SYMBOL:  $\pm 15V$  OR  $\pm 16V$  OR  $\pm 22V$  DENOTES CONNECTION POINTS OF S...
11.  $\bigcirc$  SYMBOL: TERMINAL ON PRINTED WIRING BOARD.

094-041176-1F

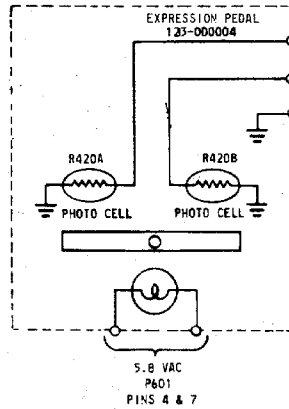

400MV P-P  
FROM R338 & R339

C314  
.0047

P701	FREQ. #	LEAD COLOR
1	37	BRN
2	36	DRN
3	35	YEL
4	34	GRN
5	33	BLU
6	32	·VID
7	31	GRA
8	30	WHT
9	29	WHT/BRN
10	28	WHT/RED
11	27	WHT/DRN
12	26	WHT/YEL
15	25	WHT/GRN

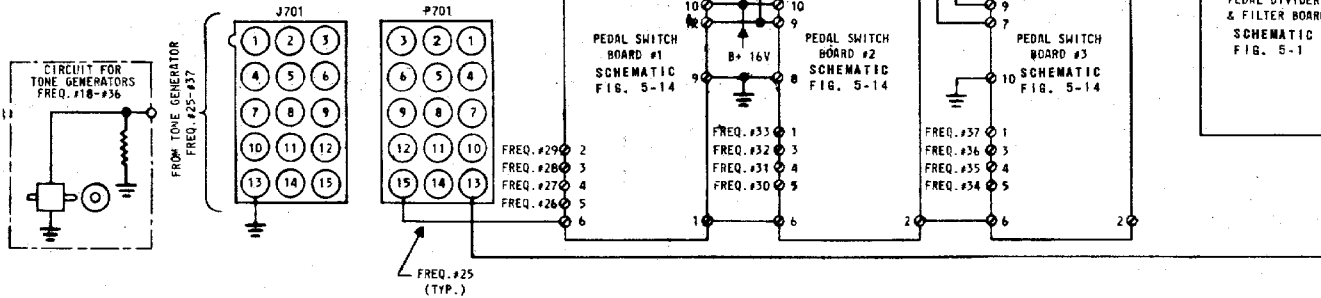

Figure 5-33

LOWER MANUAL BUS AMPLIFIER.  
 UPPER MANUAL BUS AMPLIFIER.  
 CONTROL ASSEMBLY.  
 EXPRESSION CONTROL, EMO BLOCK ASSEMBLIES, LESLIE, BAFFLE BOARD & MISC.  
 PERCUSSION BOARD.  
 AMPLIFIER & POWER SUPPLY CHASSIS.  
 PEDAL SWITCHBOARDS & PEDAL DIVIDER BOARD.  
 RECOVERY & NON-VIBRATO BOARD.

12. P701, J701 OMITTED ON 1969 AND LATER PRODUCTION. REPLACED BY DIRECT WIRING.
13. ALL ORGAN LEVELS MEASURED WITH VOLUME SOFT TAB UP, BRILLIANCE TAB UP, EXPRESSION PEDAL AT MAXIMUM.
14. MAIN ORGAN LEVELS MEASURED WITH 8' DRAWBAR AT POSITION 8, DRAWBARS AND PERCUSSION TAB DOWN, VIBRATO TAB UP AND KEY #25 UPPER MANUAL DEPRESSED.
15. ALL SWITCHES SHOWN IN TAB UP POSITION.

FD.  
 NOTES CONNECTION POINTS OF SAME VOLTAGE (FOR REGULATED VOLTAGES ONLY).  
 BOARD.

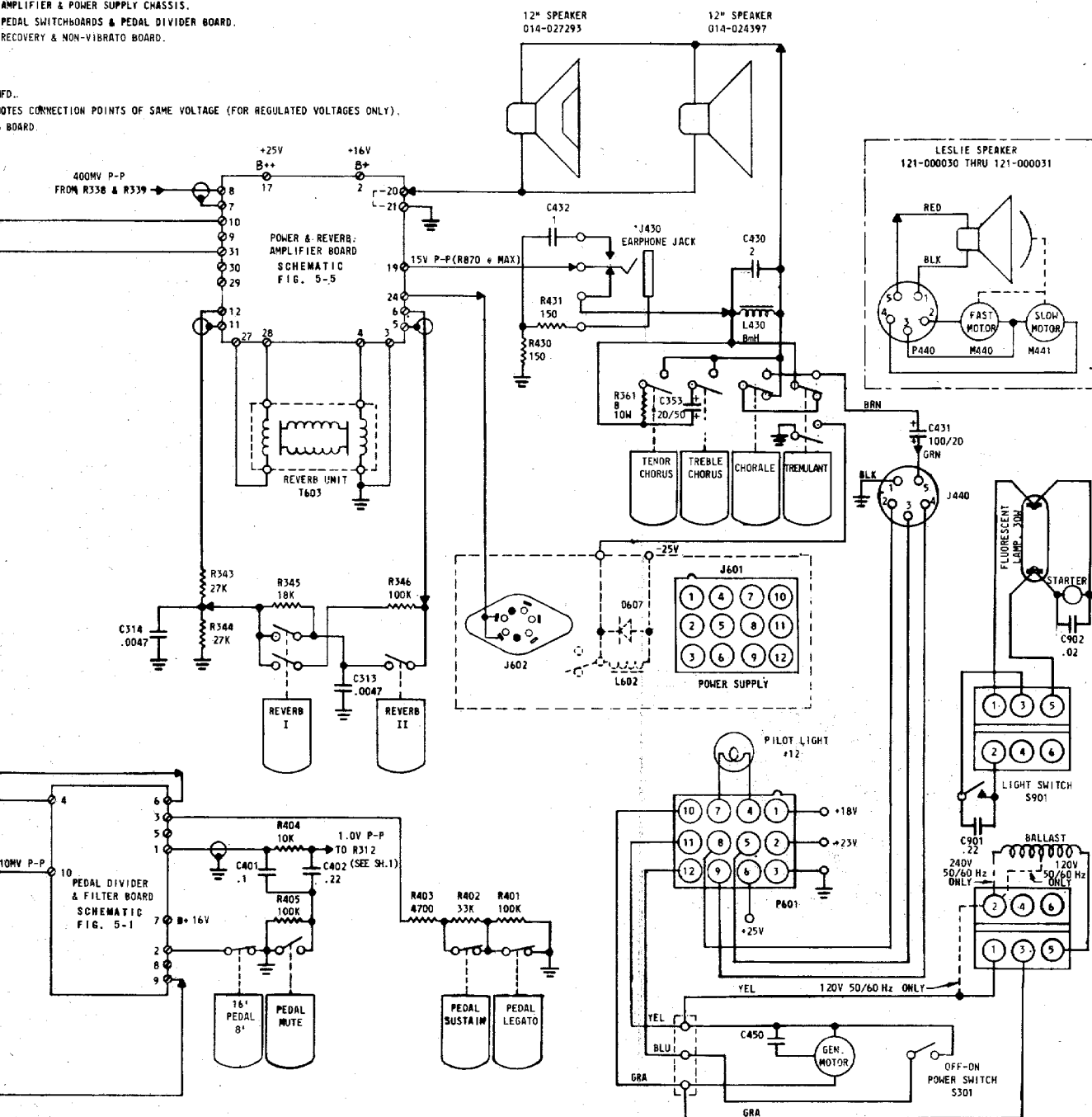
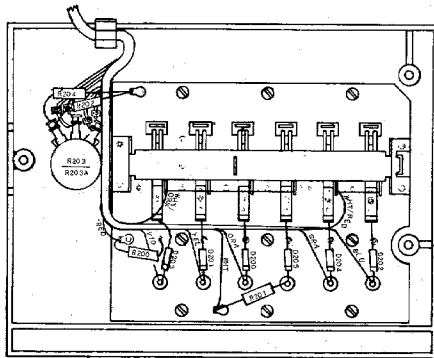
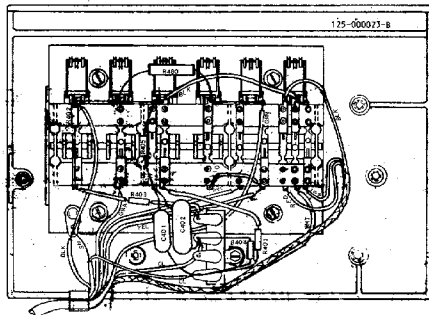

Figure 5-33



125-000069

Figure 5-34  
Six-Voice Rhythm End Block  
125-000069



125-000073-B

Figure 5-35  
Special Effects End Block

TRANSFORMER U  
FOR 220V OPERA

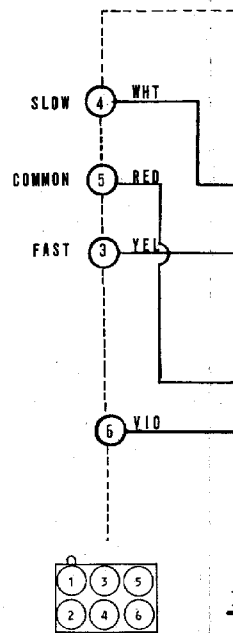
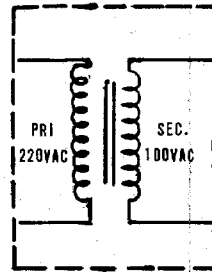

TO ROTARY  
SPEAKER

WHT

BLK







- NOTES:
1. SYMBOL TERMINAL ON PRINTED WIRING BOARD.
  2. UNLESS OTHERWISE SPECIFIED, RESISTORS ARE 1/4 WATT.
- ALL CONNECTIONS ARE IN MICROAMPS.

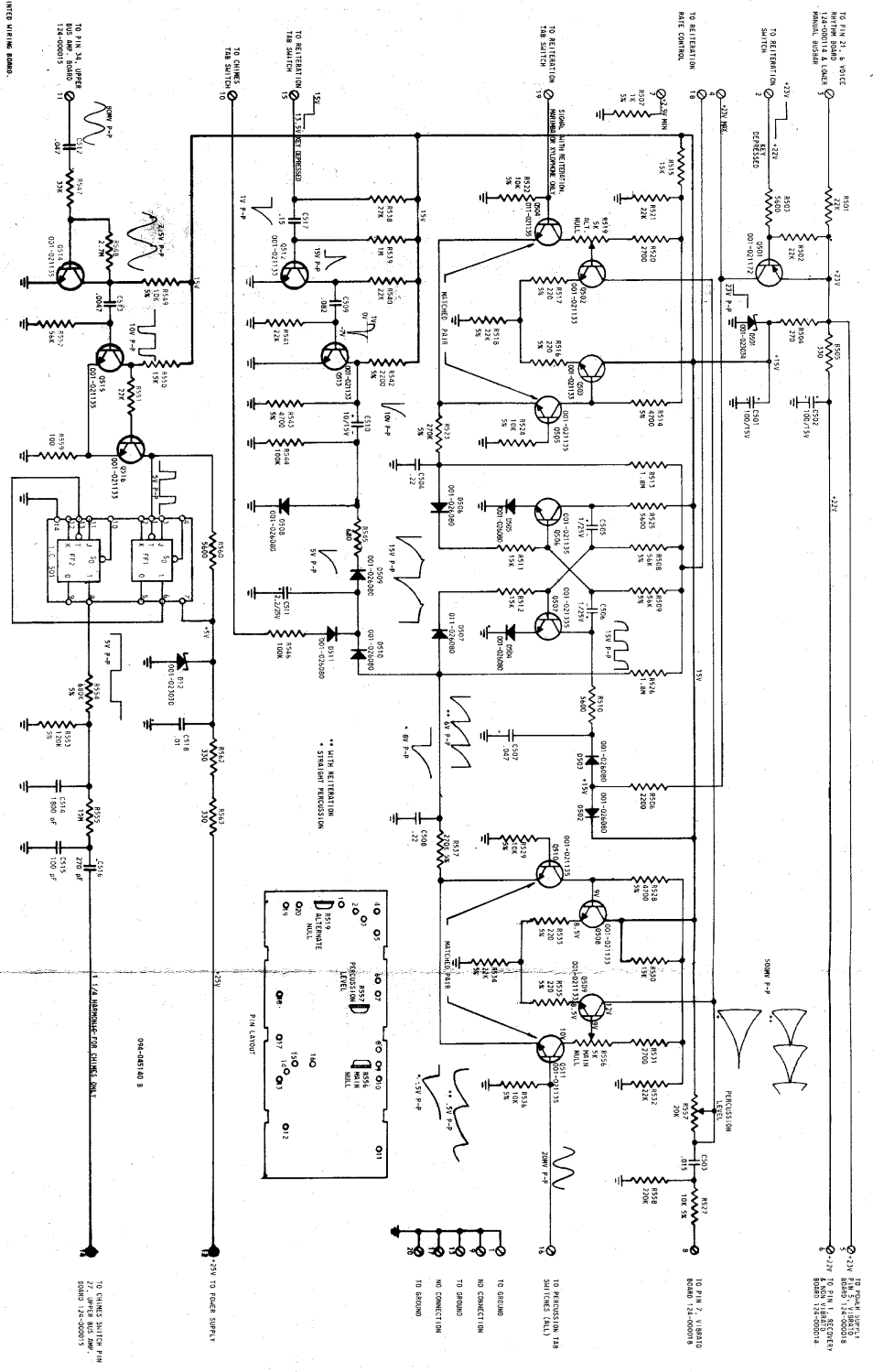

Figure 5-37  
Percussion Board 124-000170

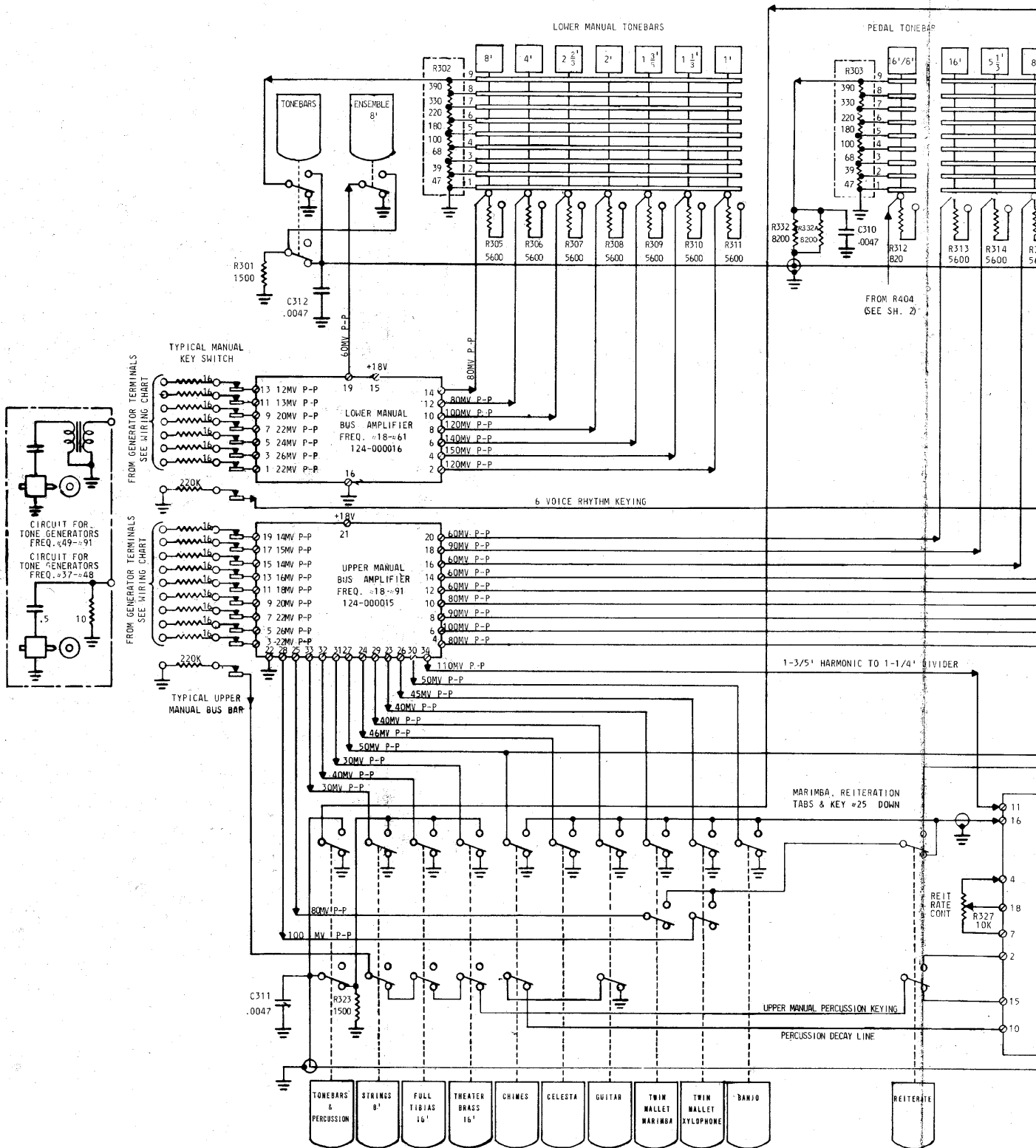
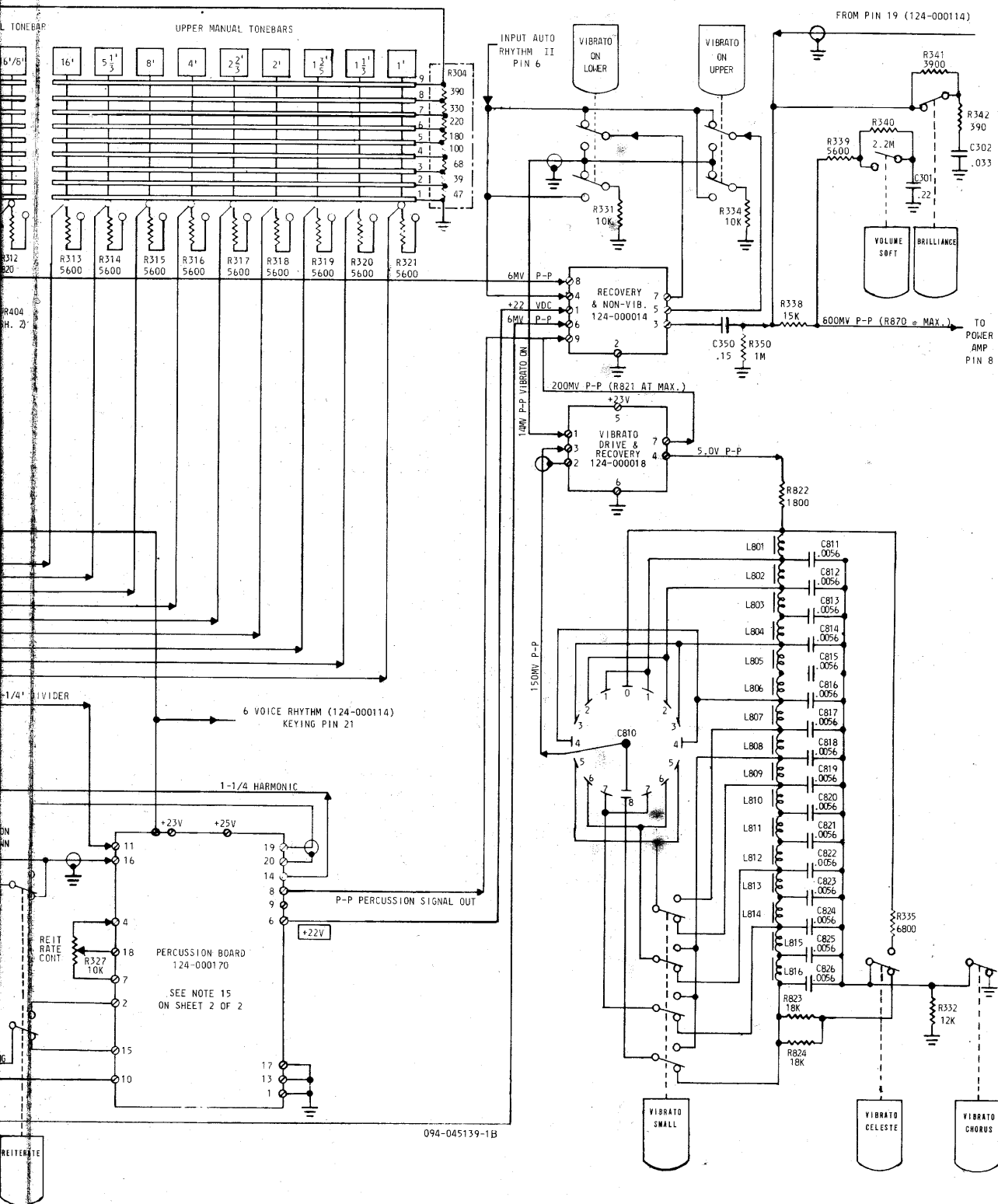



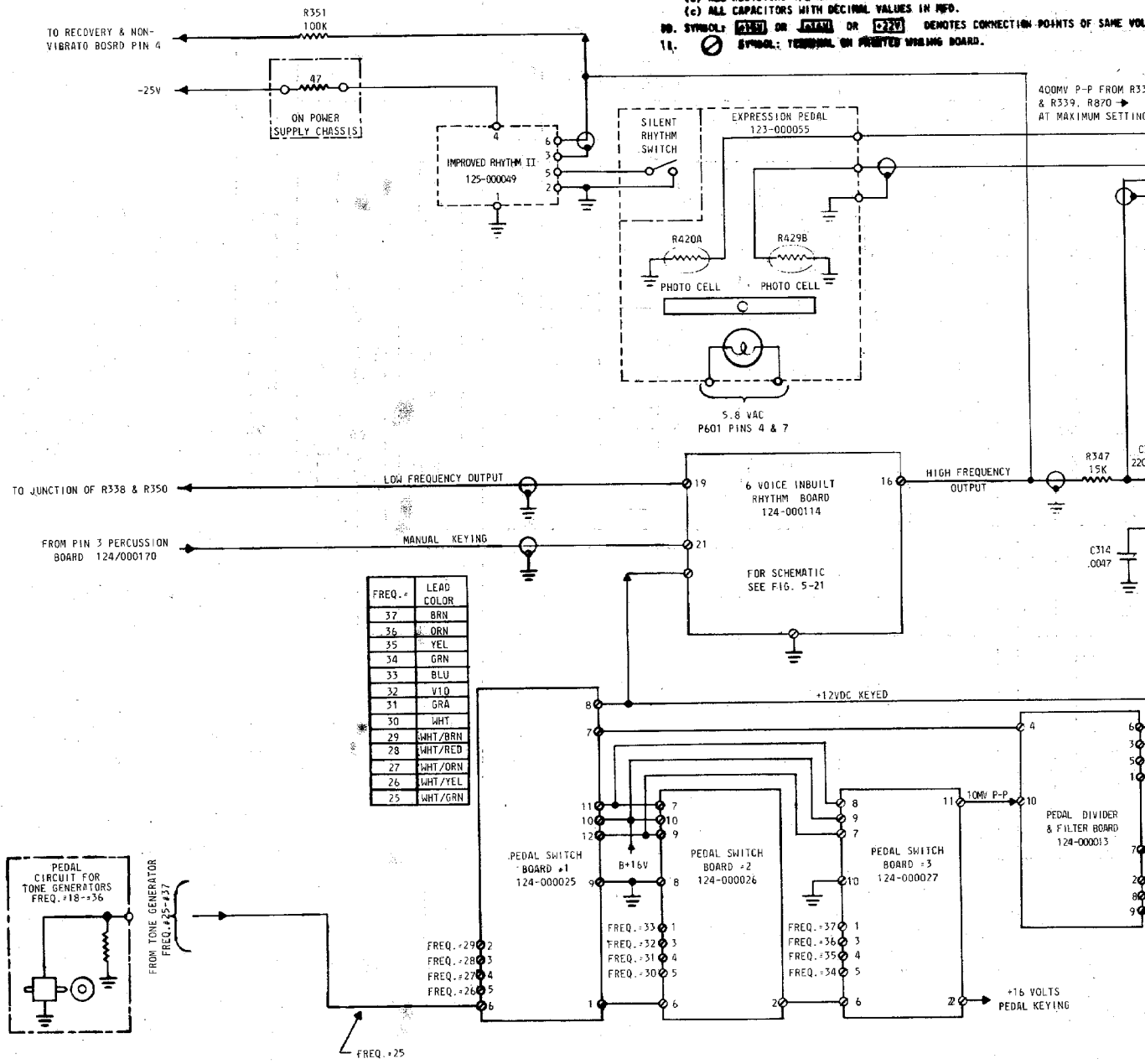

Figure 5-38



094-045139-1B

- NOTES:
- COMPONENTS NO. 100 THRU 199 ARE LOCATED ON LOWER MANUAL BUS AMPLIFIER.
  - COMPONENTS NO. 200 THRU 299 ARE LOCATED ON UPPER MANUAL BUS AMPLIFIER.
  - COMPONENTS NO. 300 THRU 399 ARE LOCATED ON CONTROL ASSEMBLY.
  - COMPONENTS NO. 400 THRU 499 ARE LOCATED ON EXPRESSION CONTROL, END BLOCK ASSEMBLY.
  - COMPONENTS NO. 500 THRU 599 ARE LOCATED ON PERCUSSION BOARD.
  - COMPONENTS NO. 600 THRU 699 ARE LOCATED ON AMPLIFIER & POWER SUPPLY CHASSIS.
  - COMPONENTS NO. 700 THRU 799 ARE LOCATED ON PEDAL SWITCHBOARDS & PEDAL DIVIDER.
  - COMPONENTS NO. 800 THRU 899 ARE LOCATED ON VIBRATO PHASE SHIFT LINE, VIBRATO ASSEMBLY.
  - UNLESS OTHERWISE SPECIFIED:
    - ALL RESISTANCE VALUES IN OHMS, 210M
    - ALL RESISTORS 1/2 WATT
    - ALL CAPACITORS WITH DECIMAL VALUES IN MFD.
  - SYMBOL:  OR  OR  DENOTES CONNECTION POINTS OF SAME WIRE.
  - SYMBOL:  DENOTES TERMINAL ON PRINTED WIRING BOARD.



FREQ. #	LEAD COLOR
37	BRN
36	ORN
35	YEL
34	GRN
33	BLU
32	VIO
31	GRA
30	WHT
29	WHT/BRN
28	WHT/RED
27	WHT/ORN
26	WHT/YEL
25	WHT/GRN

Figure 5-39

R MANUAL BUS AMPLIFIER.  
 R MANUAL BUS AMPLIFIER.  
 R CONTROL ASSEMBLY.  
 R EXPRESSION CONTROL, END BLOCK ASSEMBLIES, 'OUTLET BOX & MISC.  
 R TUNING BOARD.  
 R AMPLIFIER & POWER SUPPLY CHASSIS.  
 R 'SWITCHBOARDS & PEDAL DIVIDER BOARD.  
 R VIBRATO PHASE SHIFT LINE, VIBRATO DRIVE & RECOVERY BOARD, RECOVERY & NON-VIBRATO BOARD.

12. ALL ORGAN LEVELS MEASURED WITH VOLUME SOFT TAB UP, BRILLIANCE TAB UP, EXPRESSION PEDAL AT MAXIMUM
13. "A1K ORGAN LEVELS MEASURED WITH B' DRAWBAR AT POSITION 8, DRAWBARS AND PERCUSSION TAB DOWN, VIBRATO TAB UP AND KEY #25 UPPER MANUAL DEPRESSED.
14. ALL SWITCHES SHOWN IN TAB UP POSITION.

CONNECTION POINTS OF SAME VOLTAGE (FOR REGULATED VOLTAGES ONLY).  
 NO.

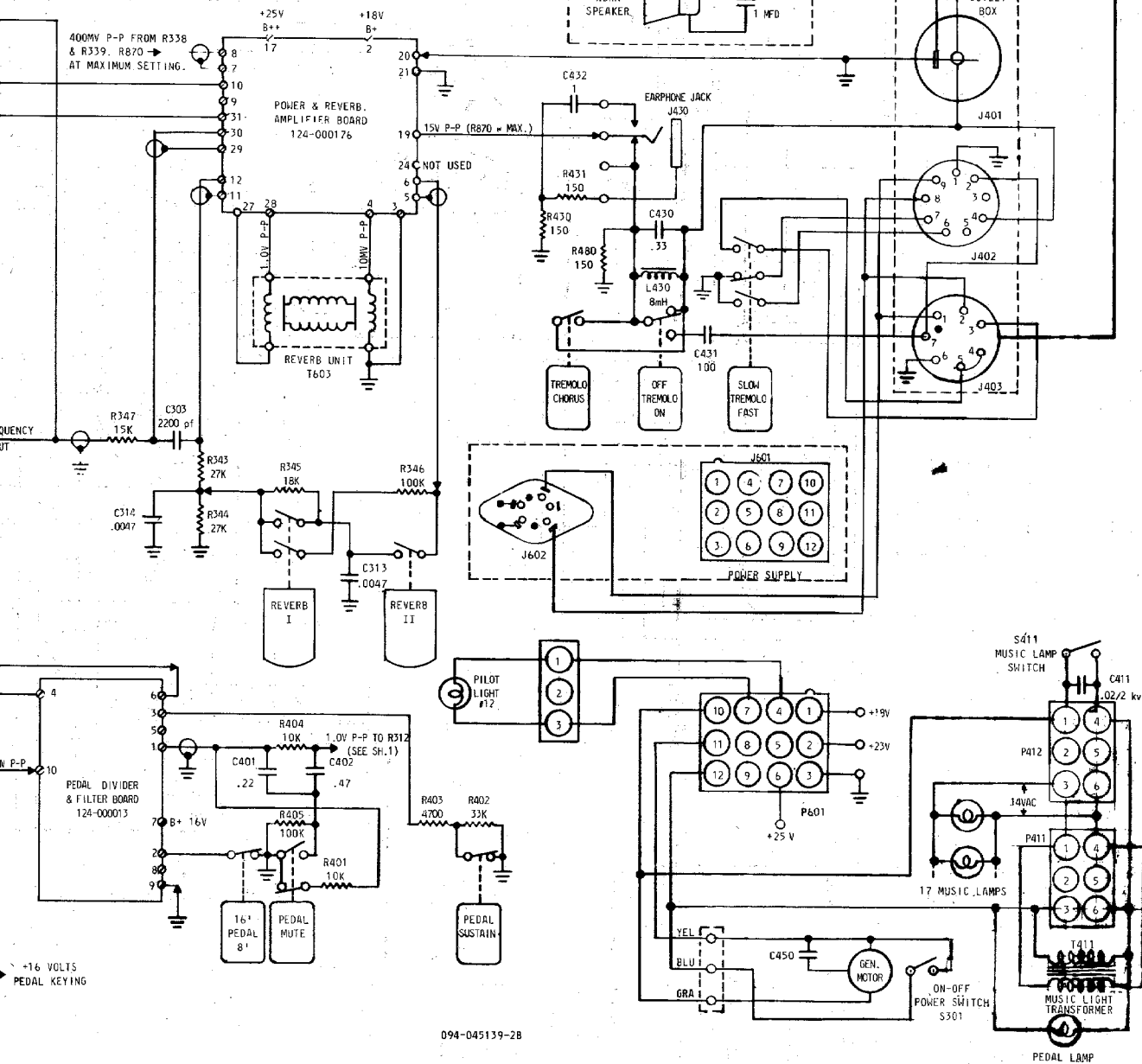

094-045139-2B





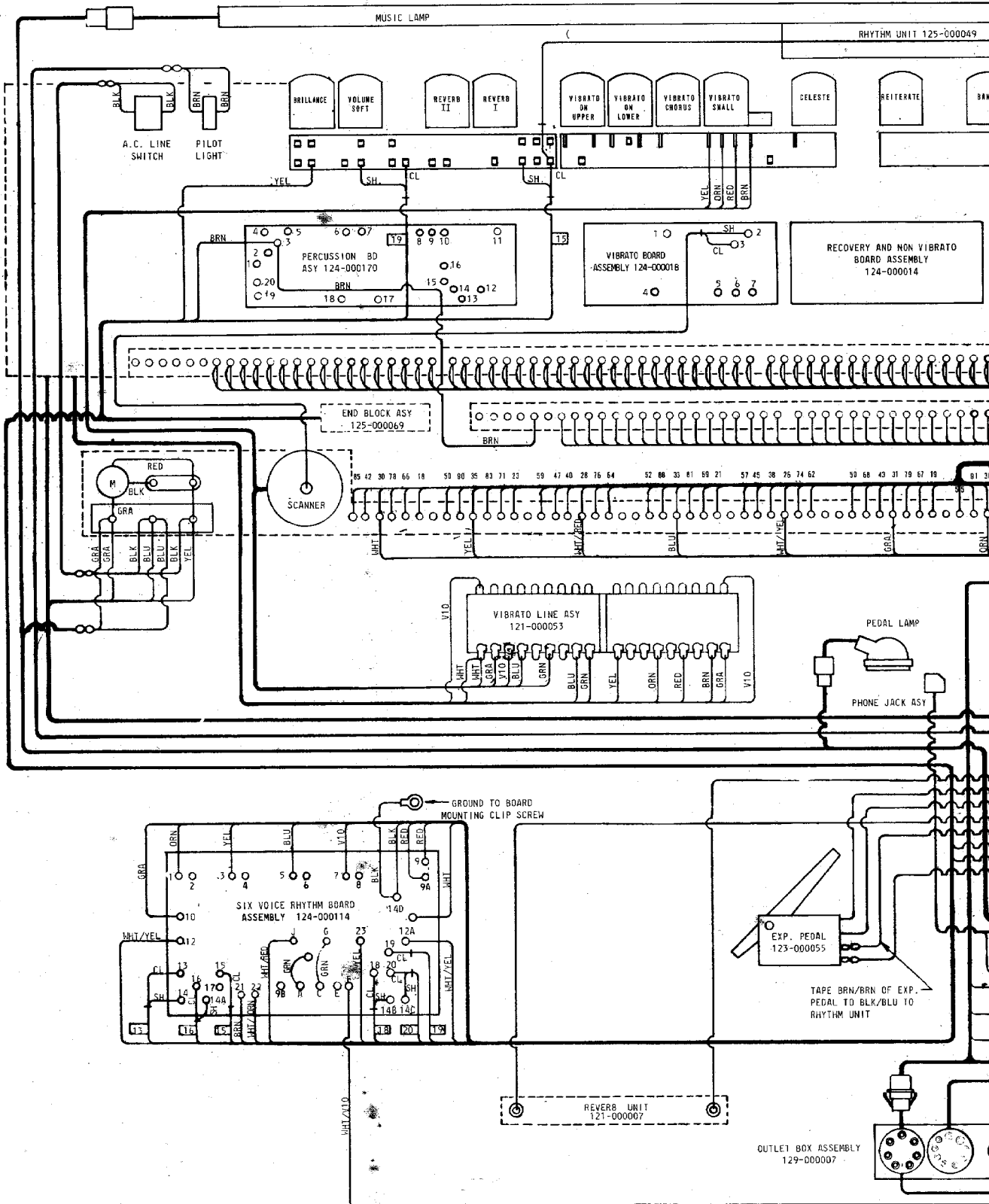

Figure 5





# SECTION VI PARTS LIST

## INDEX

		<i>Page</i>
<b>UPPER MANUAL AND CONTROL PANEL ASSEMBLY</b>		6-3
Upper Manual Assembly	119-000004	6-3
Control Panel Assembly	120-000006	6-3
Stop Finger Tabs		6-3
Tab Mounting Components		6-3
Playing Keys		6-4
Drawbar Assembly		6-4
Switch Panel Assemblies		6-4
<b>LOWER MANUAL ASSEMBLY</b>	119-000003	6-4
Playing Keys		6-4
Lower Left End Block	T-100	6-5
Lower Right End Block	T-100	6-5
Lower Right End Block	T-200	6-5
Lower Left End Block	T-200-300-400	6-5
Lower Right End Block	T-200-1-2, T-400	6-6
<b>PRINTED WIRING BOARDS</b>		6-6
Percussion Board Assembly	124-000181	6-6
Percussion Board Assembly (T-262)	124-000113	6-8
Vibrato Board Assembly	124-000018	6-8
Recovery and Non-Vibrato Board	124-000014	6-9
Upper Manual Bus Amp Board	124-000015	6-10
Lower Manual Bus Amp Board	124-000016	6-10
Brush and Cymbal Board (T-100, T-200)	124-000020	6-11
Power and Reverb Amp Board	124-000017	6-11
Pedal Divider Board	124-000013	6-12
Pedal Keyer Board #1	124-000025	6-13
Pedal Keyer Board #2	124-000026	6-13
Pedal Keyer Board #3	124-000027	6-13
Detector Board (Rhythm Rail)	124-000024	6-14
Voice Board (Rhythm Rail)	124-000023	6-15
Rhythm Board (Used with 6 Button Rhythm)	124-000114	6-15
<b>POWER SUPPLY AND AMPLIFIER ASSEMBLIES</b>		6-17
<b>POWER SUPPLY ASSEMBLY (RHYTHM RAIL)</b>		6-17
<b>PEDAL KEYBOARD AND SWITCH ASSEMBLY</b>	116-000002	6-18
<b>WOODWORK ASSEMBLIES</b>		6-18
Cabinet Assemblies		6-18
Bench Assemblies		6-18
Case Assemblies		6-18
Top Panels		6-19
Music Panels		6-19
Rear Covers		6-19
Baffle and Grille Cloths		6-19

<b>RHYTHM RAIL ASSEMBLY T-300 AND KITS</b>	6-19
<b>RHYTHM II ASSEMBLIES (AUTOMATIC RHYTHM)</b>	6-20
<b>MISCELLANEOUS</b>	6-20
Swell Pedal Components	6-20
Leslie Speaker Assemblies	6-20
Generator Assemblies	6-20
Scanners	6-21
Speakers	6-21

## XTP

<b>CONTROL ASSEMBLY</b>	6-21
Stop Finger Tabs	6-21
Control Panel Assembly	6-21
Switch Panel Assemblies	6-21
<b>PERCUSSION BOARD ASSEMBLY</b>	6-22
Trimmer Potentiometers	6-22
Transistors	6-22
Integrated Circuit	6-22
<b>END BLOCK ASSEMBLY (LEFT HAND)</b>	6-23
Rocker Tab Switches	6-23
<b>END BLOCK ASSEMBLY (RIGHT HAND)</b>	6-23
<b>EXPRESSION PEDAL ASSEMBLY</b>	6-23
Photo Cell	6-23
Light Diffuser	6-23
Light Bulb	6-23
<b>PEDAL KEYBOARD AND SWITCH ASSEMBLY</b>	6-23
<b>POWER AMPLIFIER ASSEMBLY</b>	6-23
<b>WOODWORK</b>	6-24
Case Assembly	6-24
Bench Assembly	6-24
Top Panel Assembly	6-24
<b>MISCELLANEOUS</b>	6-24
Crossover Network Assembly	6-24
Lower Manual Cover	6-24
Music Light Transformer	6-24
Speaker Cabinets	6-24

**END BLOCK AND ROCKER ASSEMBLY LEFT HAND 125-000073**

End Block Cover Left Hand (Textured)		009-045147
Rocker Tab Switch Assembly (Left Hand)		008-045018
Rocker Switch Frame Assembly		008-045014
Over Center Spring		012-030819
Shaft		020-031771
Adhesive Backed Felt		042-031761
Stamped Rocker Tab (Pedal Sustain)		031-044624
Stamped Rocker Tab (16' Pedal 8')		031-033777
Stamped Rocker Tab (Pedal Mute)		031-033778
Stamped Rocker Tab (Tremolo Chorus)		031-044625
Stamped Rocker Tab (Off-On Tremolo)		031-044627
Stamped Rocker Tab (Slow-Fast Tremolo)		031-044626
End Block Left Hand		025-045015
Capacitor, Mylar Film	.47 MF 50 V.D.C.	405-040252
Capacitor, Mylar Film	.22MF 50 V.D.C.	405-040212

**END BLOCK AND ROCKER ASSEMBLY RIGHT HAND 125-000069**

End Block Cover Right Hand (Textured)	009-45148
---------------------------------------	-----------

**EXPRESSION PEDAL ASSEMBLY 123-000055**

Pedal Base and Felt Assembly	060-030804
Shutter Assembly	060-033749
Cell and Housing Wiring Assembly	040-044871
Diffuser	016-030153
Photo Cell Housing Cover	025-032880
Light Bulb Socket and Terminal Assembly	011-044878
Light Bulb	016-031748
Extension Spring	012-030154
Pedal Assembly	123-000056

**PEDAL KEYBOARD AND SWITCH ASSEMBLY 116-000003****POWER AMPLIFIER ASSEMBLY (120V-60Hz) 126-000070**

Chassis Assembly (Riveted)			009-031032	
Power and Reverb Amp Board			124-000176	
Pedal Divider Board			124-000013	
Cord and Plug Assembly (AC)			011-045043	
Transistor Heat Sink			041-044539	
Teflon Insulator			036-032018	
Terminal Lug			007-021616	
Strain Relief (AC)			013-034996	
Plug (Bottom)			005-045226	
Capacitor, Electrolytic	1500Mfd	25V (Sleeve)	450-060010	
Capacitor, Electrolytic	1500Mfd	25V	450-060020	
Capacitor, Electrolytic	3000Mfd	30V	450-060030	
Capacitor, Electrolytic	1000Mfd	25V	407-060149	
Power Transistor	(Matched Color Dots)		001-012050	
Power Transformer	(120V	60Hz)	003-031070	
Power Transformer	(120/220V -	50/60Hz)	003-031327	
Silicone Compound			007-029624	
Capacitor	.02Mfd	1000 Volt	C620	425-020770
Resistor, Fixed	1/2 Watt	47 $\Omega$ $\pm$ 10%		600-020171
Resistor, Fixed	1/2 Watt	10 $\Omega$ $\pm$ 10%		600-020011
Resistor, Fixed	2 Watt	50 $\Omega$ $\pm$ 5%		600-040242
Resistor, Fixed	3 Watt	400 $\Omega$ $\pm$ 5%		602-050102
Silicon Rectifier				001-024051
Zener Diode	15 Volt	1 Watt		001-023034

POWER AMPLIFIER ASSEMBLY 120V 50-60 Hz 126-000071

POWER AMPLIFIER ASSEMBLY 220V 50-60 Hz 126-000072

### WOODWORK

Case Assembly	050-002525
Music Panel (Complete)	050-002520
Cabinet Assembly	111-000128
Bench Assembly	152-000054
Top Panel Assembly	125-000072
Top Panel	050-002485
Rhythm Unit	125-000049
Phillips Head Countersink (4 Used)	935-030538
Lampholder and Hinge Wiring Assembly	063-044299
Lens (Top)	026-044639
Lens Diffuser (Bottom)	016-044640
Rhythm Knobs (2 Used)	031-042578
Music Panel Hinge (2 Used)	032-033416
Music Panel Lights (12 Volt) 17 Used	016-031749
Front Panel (Rhythm Cover)	061-044635
Logo	037-043351

### MISCELLANEOUS

End Block (Textured) Upper Right Hand	025-035707
Control Cover	041-031022
Front Strip	041-044668
Frame Assembly	060-044565
Heat Shield (Power Output Transistors)	010-044472
Grommet Rear Cover (Music Light Cover)	043-020675
Outlet Box Assembly	129-000007
Crossover Network Assembly	063-044888
Phone Jack Terminal Strip Assembly	063-044889
Phone Jack Assembly	005-044868
Base	050-002516
Cover Music Light	041-044472
Base Rear Cover	041-044579
Pedestal Trim Strip (Rear 20½")	055-045038
Pedestal Trim Strip (Front 18½")	055-045039
Hammond Logo*	037-025943
Filler*	050-000883
Cable Assembly Rhythm II	011-044880
Lower Manual Cover (Molded)	025-045036
Pedal Lamp Assembly	016-039392
Vibrato Drum Scanner Assembly	066-042874
Pedal Lamp                   120V     6 Watt	GE-6S6
Music Light Transformer    120V    50 Hz	003-044481
Music Light Transformer    120V    60 Hz	003-044484
Music Light Transformer    220V   50-60 Hz	003-044480

\*1 EACH REQUIRED FOR COMPLETE ASSEMBLY—GLUE NOT INCLUDED

Main Speaker Cabinet Assembly	102-000055
Cabinet and Grill Cloth Assembly	052-045132
Grill Cloth	053-045114
12" P M Speaker	014-045044
Horn Speaker	014-032169
Rotary Speaker Cabinet Assembly   120V   50/60 Hz	102-000056

<b>Rotary Speaker Cabinet Assembly</b>	<b>220V</b>	<b>50/60 Hz</b>	<b>102-000057</b>
<b>Cabinet and Grill Cloth Assembly</b>			<b>052-045131</b>
<b>Rotary Tremolo Unit</b>	<b>120V</b>	<b>50/60 Hz</b>	<b>121-000134</b>
<b>Rotary Tremolo Unit</b>	<b>220V</b>	<b>50/60Hz</b>	<b>121-000135</b>
<b>Tremolo Cable Assembly (For 102-000056)</b>			<b>011-045177</b>
<b>Tremolo Cable Assembly (For 102-000057)</b>			<b>011-045832</b>
<b>Transformer (For 220Volt Operation)</b>			<b>003-045814</b>

