



XBASE 999

ANALOG DRUM SYNTHESIZER

Operating Manual

OS 1.3x

INTRODUCTION 8

 A BRIEF INTRODUCTION TO THE XBASE 999 8

 MANUAL CONVENTIONS 9

 CONNECTION 9

 POWER SUPPLY 9

 AUDIO CONNECTIONS 10

 MIDI CONNECTIONS 10

 MIDI OUT 10

 MIDI THRU 11

 QUICK START 11

THE USER INTERFACE 16

 INPUT GAIN 17

 PHONES 17

 MASTER 17

 DATA/TEMPO 17

 LEFT/RIGHT 18

 MASTER 18

 EDIT 18

 MIDI 18

 BANK 18

 A/B 18

 SCALE 18

 PERF 19

 PATT 19

 SONG 19

 WRITE 19

 DOWN/UP 19

 START 19

 STOP 19

 ENTER 20

 SHIFT/CANCEL 20

 SCALE BARS 20

 STEP 1...16 BUTTONS AND LEDS 20

 INSTRUMENT KEYS 20

MASTER MODE 21

- KIT SELECTION 21
- NAMING OF A KIT 22
- DISPLAY CONTRAST 22
- MEMORY PROTECT 23
- INITIALISATION OF THE CURRENT KIT 23
- EDIT MODE 24
 - SELECTION OF A DRUM KIT 24
 - SELECTION OF AN INSTRUMENT 24
- ANALOGUE SOUND ENGINE 25
 - BASS DRUM 25
 - Tune* 25
 - Pitch* 25
 - Attack* 25
 - Decay* 26
 - Gate* 26
 - Harmonics* 26
 - Pulse* 26
 - Noise* 27
 - EQ* 27
 - Compress* 27
 - Level* 27
 - Velocity* 28
 - Scale* 28
 - Initialize* 28
 - SNAREDRUM 29
 - Tune* 29
 - Snappy* 29
 - Decay* 29
 - Detune* 29
 - Noise Tune* 30
 - Level* 30
 - Velocity* 30
 - LOW TOM 31
 - Tune* 31
 - Decay* 31

<i>Level</i>	31
<i>Velocity</i>	31
HIGH TOM.....	32
<i>Tune</i>	32
<i>Decay</i>	32
<i>Level</i>	32
<i>Velocity</i>	32
SAMPLE BASED INSTRUMENTS	33
THE VCA ENVELOPE.....	33
HI HAT.....	34
<i>Tune</i>	34
<i>Closed Hi Hat Attack</i>	34
<i>Closed Hi Hat Decay</i>	35
<i>Closed Hi Hat Peak Time</i>	35
<i>Open Hi Hat Attack</i>	35
<i>Open Hi Hat Decay</i>	35
<i>Open Hi Hat Peak Time</i>	36
<i>Hi Hat Sample Select</i>	36
<i>Reverse Play</i>	36
<i>Source</i>	37
<i>Low Pass Filter Cutoff</i>	37
<i>High Pass Filter Cutoff</i>	38
<i>Filter Resonance</i>	38
<i>Level</i>	38
<i>Velocity</i>	39
<i>Initialization</i>	39
CLAP, RIM, CRASH AND RIDE	39
<i>Tune</i>	39
<i>Attack</i>	40
<i>Decay</i>	40
<i>Peaktime</i>	40
<i>Reverse Play</i>	41
<i>Sample Selection</i>	41
<i>Level</i>	41
<i>Velocity</i>	42
<i>Initialize</i>	42

THE LFOs	43
<i>LFO1 Waveform</i>	43
<i>LFO1 Destination</i>	43
<i>LFO1 Intensity</i>	44
<i>LFO1 Rate</i>	44
<i>LFO2 Waveform</i>	44
<i>LFO2 Destination</i>	45
<i>LFO2 Intensity</i>	45
<i>LFO2 Rate</i>	45
<i>Synchronization of LFO1</i>	46
<i>Synchronization of LFO2</i>	46
THE FILTER	47
CUTOFF LEFT	48
CUTOFF RIGHT.....	48
Q LEFT.....	48
Q RIGHT	49
RESONANCE LEFT.....	49
RESONANCE RIGHT.....	49
FILTER MODE LEFT	49
FILTER MODE RIGHT.....	50
FILTER GAIN	50
FITER VCA OUT	50
MIDI MODE	51
RECEIVE CHANNEL	51
TRANSMIT CHANNEL	51
BULK DUMP	51
BULK LOAD.....	52
TRANSMIT PROGRAM CHANGE	52
TRANSMIT MIDI CONTROLLERS.....	53
TRANSMIT MIDI NOTE TRIGGERS	53
TRANSMIT MIDI CLOCK.....	54
THE SEQUENCER	55
PERFORM MODE	55
<i>Selection of Drum Kits</i>	55

<i>Perform Play Mode</i>	55
<i>A/B Pattern</i>	56
<i>Perform Write Mode</i>	57
<i>Programming of Patterns in Perform Write Mode</i>	57
<i>Scale</i>	57
<i>Selecting Instruments</i>	58
<i>Setting or Clearing Steps – Programming Beats</i>	59
<i>Editing of Instrument Parameters</i>	59
<i>Usage of Drum Kits</i>	60
<i>Muting Instruments</i>	61
PATTERN MODE.....	62
<i>Pattern Play Mode</i>	62
<i>Pattern Write Mode</i>	62
<i>Individual Step Edit</i>	63
<i>Track Record Mode</i>	64
<i>The Filter in Pattern Mode</i>	65
SONG MODE	67
<i>Song Mode Manual Programming</i>	69
<i>Song Mode Realtime Programming</i>	71
<i>Defining Loops</i>	73
2ND FUNCTIONS	74
STORE KIT (1)	74
CLEAR PATTERN (2)	75
STORE PATTERN (3).....	75
A/B PLAYMODE (4).....	76
LAST STEP (5)	76
SHUFFLE (6).....	77
REALTIME WRITE (7).....	78
FILTER ROUTING (8)	79
STEREO PANNING (9)	80
SPLIT MODE (10).....	81
CLOCK SELECT (11).....	81
METRONOME (12)	82
SAMPLE SELECT (13).....	82
REVERSE (14).....	83
LFO PAGE (15)	83

MIDI TRACKS (16) 84

APPENDIX 87

MIDI IMPLEMENTATION XBASE 999 87

 1. *Sound Parameter (Continuous Controllers)* 87

 2. *Note Commands*..... 93

 3. *Sysex Commands*..... 93

Preset bulk dump 93

OS bulk dump..... 93

Flash bank bulk dump..... 94

Flash bank erase command 94

Dump request command 94

SPECIFICATIONS..... 95

Introduction

Thank you for using the JoMoX XBASE 999!
We are pretty confident that that you'll have lots of joy and entertainment with this incredible sounding analog drum synthesizer!

A brief introduction to the XBASE 999

The XBASE 999 is a drum machine with 9 instruments. Four of them are completely made up of advanced analog discrete circuitries and combine true analog sound with the advantage of full digital control of all parameters. The other 5 instruments are based on short 8 bit samples which are processed by an analog VCA envelope. They are of course also controllable in the digital domain. Thus they can be stored in memory and be remotely controlled by Midi.
In order to affect the analog sound production as little as possible, all D/A converters are specially adapted to the parameters and being integrated into the circuitry. By doing so, the parameter control is provided for each trigger almost without any delay – which makes the necessary technical efforts in the XBASE 999 quite big.

Additionally, the XBASE 999 has a great sounding stereo filter that allows for independent control of cutoff, Q and resonance. It is also controllable by Midi CC and can be sequenced by the internal sequencer with every of its parameters.

By using encoders instead of potentiometers annoying jumps of parameters belong to the past. Basically the editing of all instrument parameters is possible by the 16 encoders or by using the left / right cursor buttons and the data wheel.

The heart of a drum machine is of course the sequencer. The XBASE 999 has a classic step sequencer with step LEDs which also lets you edit various quantizes for each track and step with midi clock sync

and shuffle mode options. Furthermore, 4 additional programmable midi tracks can trigger external instruments. In Pattern Mode, the XBASE 999 can control all the sound settings for each step to obtain melodies and really freaky grooves. So, for instance, you can "abuse" the kick drum with long decay for creating a bass line due to it's extremely flexible sound programming. On the sample based instruments each step can trigger a different sample if you want to. Each sample based instrument contains 31 different samples. With XBASE 999 it is possible now to reload them into the internal flash memory by midi sample dump. A PC/MAC tool for a convenient download can be downloaded at www.jomox.com.

Manual conventions

In order to make this manual better understandable, in the following text passage all user interface descriptions of the XBASE 999 are set into round brackets and printed **bold**.

i.E.

*Press the **(Master)** button.*

Display contents and values are printed like this: <**Perf000**>

Connection

Please use the XBASE 999 only in dry rooms not warmer than 35° C (95° F).

On the back panel of the enclosure you will find following connections:

Power Supply

Please connect the provided wall wart adapter to the line and hook it up to the supply jack 10.5V~ AC IN on the XBASE 999. If, for any reason, you are not able to use the original power supply, please use an alternate current AC/AC adapter with at least 10.5 Volts and 2 amps. Some common halogen transformers like 12V~ AC 2 amps

with the appropriate plug connected could work.
Please never use an AC/DC adapter as the XBASE 999 might get damaged!

Audio connections

Please turn off the XBASE 999 and the mixer.

The XBASE 999 has a stereo main output that mixes all instruments and the filter. If you plug a cable into an individual output, this instrument is spared out from the stereo mix. All audio outputs are unbalanced.

In the stereo main output the pure filter signal is lead out on the ring of the stereo ¼" jack. So if you use an insert cable, you have access to the mix signal and the pure filter signal without final VCA.

Please connect the audio outputs by ¼ " audio cables with the audio inputs of your mixer.

MIDI Connections

The MIDI in jack of the XBASE 999 is used for remote playing, controlling and synchronization by other MIDI capable devices like master keyboards and computers.

*» **Note:** please only send as much Midi data as necessary. The more Midi data has to pass the MIDI cable the worse the timing gets. Use different Midi ports for different machines as the Midi protocol is serial and consumes time and performance.*

Please look into the Midi Implementation in the appendix which Midi data is received and processed by the XBASE 999.

Connect the MIDI In jack of the XBASE 999 with the MIDI Out jack of the master by use of a midi cable.

MIDI OUT

By MIDI out the XBASE 999 transmits midi data to other devices as

computers, synthesizers and others. Connect the MIDI Out jack of the XBASE 999 to the Midi In jack of the other device.

MIDI Thru

Midi data that is received on the MIDI In jack is being forwarded to the MIDI Thru jack without being changed. More MIDI capable devices can be connected to this port.

Quick Start

Connect the XBASE 999 to an appropriate amplifier or to a mixer. Before you turn on, please turn the master level at your mixer or amplifier down.

On initial boot up sequence, you are welcomed by the following display:

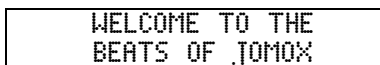

```
WELCOME TO THE
BEATS OF JOMOX
```

Press the **(Start)** button to start the sequencer. Now you can adjust the Master or the Phones knob to a convenient volume.

» **Note:** *the Master volume knob is only working in the digital domain by multiplying controls to the internal instrument level control voltages and may reduce the internal dynamics if it's turned low. For best performance and sound, leave it to maximum value 127 and use the external mixer to control the volume.*

By pressing one of the 16 **(Step)** buttons you can select another pattern in the current bank. Alternatively you can use the the **(Up)** and **(Down)** buttons to achieve the same result. Press the **(Bank)** button to switch to another bank. You can cycle through the available 4 banks. If you want to change the tempo, press **(Master)** button and then **(Right)** button. Adjust the Tempo with the **(Data/Tempo)**

encoder.

Now that you know how to select patterns, let's take a look at the different modes of the XBASE 999. After powering up, you are always in Perform Mode. That means, all steps of an instrument track address the same sound buffer and play the same sound throughout the whole track. By editing the encoders you can change the sound of any instrument whilst the sequencer is running.

Next to each encoder there is a multi-color LED which lights up green when the corresponding parameter is existing in the selected instrument. If you want to edit a different instrument, press the **(Write)** button – now you are in Perform Write Mode. Now select the desired instrument with the light grey instrument keys, and immediately the LEDs show up the editable parameters of the selected instrument. The red LED next to the instrument key also lights up indicating the currently selected instrument.

If you don't want to edit an instrument with running sequencer, press again **(Write)** button to leave the Perform Write Mode and trigger the instrument with the instrument key.

Now let's go to the Master Mode. Press the **(Master)** button. In this mode the encoders are addressed to the individual instrument volumes and being displayed as bars in the LCD display. By pressing on one of the 9 first encoders you can mute or unmute the corresponding instrument. In case it is muted, the LED lights up red. This function is also available in the other modes regardless if it is Perform, Pattern or Edit or Master mode and regardless of any submenu. I.E. pressing encoder 1 always mutes or unmutes the kick drum.

Let's program the first own created drum pattern. Switch to bank 2 by pressing the **(Bank)** button. By pressing **(Step 1)** button choose the first empty pattern. Now go to Perform Write Mode by pressing **(Write)** and select an instrument track by pressing the corresponding instrument key i.e. the bass drum track.

Start the sequencer and press a desired **(Step)** button. The step is played when the running LED comes across. Pressing again erases the step again. Complete your instrument rhythm and switch to another instrument and select steps to be played there as well and complete your own drum pattern by layering several instruments in a rhythmic pattern.

If you want to set an accent, press the instrument key a second time so that the instrument LED starts to flash. Now you can set steps where playing steps were already set. They are lit orange to indicate that an accent is played on this step.

Now we'd like to introduce the Pattern Mode. Go back to Bank 1 as described above. Press the **(Pattern)** button to enter the Pattern Mode and listen to some of the factory patterns in bank 1 by selecting the patterns to get familiar with the possibilities of the XBASE 999.

Actually the programming in Pattern Mode works very similar to the Perform Mode, only that each step has an own sound buffer so that you can store completely different sounds for one instrument on every step.

First select an empty pattern. Now press **(Write)** to enter the Pattern Write Mode.

Set steps as described above and listen to the instrument.

Now hold the instrument key and press a desired step at the same time – the step LED will start to flash indicating that you are in Individual Step Edit Mode for this selected step.

Listen to the instrument and hear that the sound only for this step is different. You can scroll with the **(Data/Tempo)** knob through some kits and the stored sounds are copied automatically into that step sound buffer. Or you edit the instrument buffer by tweaking the instrument knobs. All sound settings are recorded into that one step buffer (or more when you select several at the same time).

When you press **(Write)** again and leave the Write Mode, these steps get locked.

You can go on and program a different bass drum for every step,

create bass lines with long decayed Bass Drums or make melodies on the Clap sound. Even the sample select of the sample based instruments can be programmed for each step separately.

If you are satisfied with your new pattern let's listen to the stereo filter.

For this you have to route some instruments into the filter—you could also insert an external signal to the filter section over the external inputs.

The instrument routing works as follows: press **(Shift/Cancel)** and then **(Step 8)** = Filter Routing.

The display shows the following:

```

Filter Routing  Perf001
xxxxxxxxx Stereo Shif008
    
```

With the **(instrument)** keys you can select the desired instruments that are to be processed by the filter.

The display shows the following i.e.:

```

Filter Routing  Perf001
x^x^~^~^~xx Stereo Shif008
    
```

Now go to Pattern Write Mode and select the filter track by pressing the **(Filter)** key. In the display every step is displayed by an "x".

```

xxx■xxx■xxx■xxx Patt001
xxx■x■x■x■x■x■x CEd B120
    
```

The upper row shows the left channel of the filter, the lower the right channel. By pressing the **(Filter)** key again you can toggle between both channels. The cursor jumps to the corresponding row. To program a filter sequence you have to select a step to be changed by the **(Step)** buttons. I.E. choose step 1,5,9 and 13. Now the display shows no "x" but a bar at the selected steps which indicates the value for this step. Additionally to the step LEDs 1..16 the LEDs next to encoder 1..16 light up when a step is set. With these encoders you

can change the selected parameter. With the **(Left)** and **(Right)** cursor buttons you can select which parameter is to be processed. There are

- C - Cutoff
- Q - Quality (Bandwith)
- R - Resonance
- V - Volume VCA

For each of them you can program a sequence that changes with every selected step.

If you like the pattern you should store it to memory. Unless you don't store it - all editings are only made in the edit buffer - it will be gone when you select another pattern.

This is made by pressing **(Shift/Cancel)**, then **(Step 3)** = Store Pattern.

Enjoy and check it out!

The User Interface

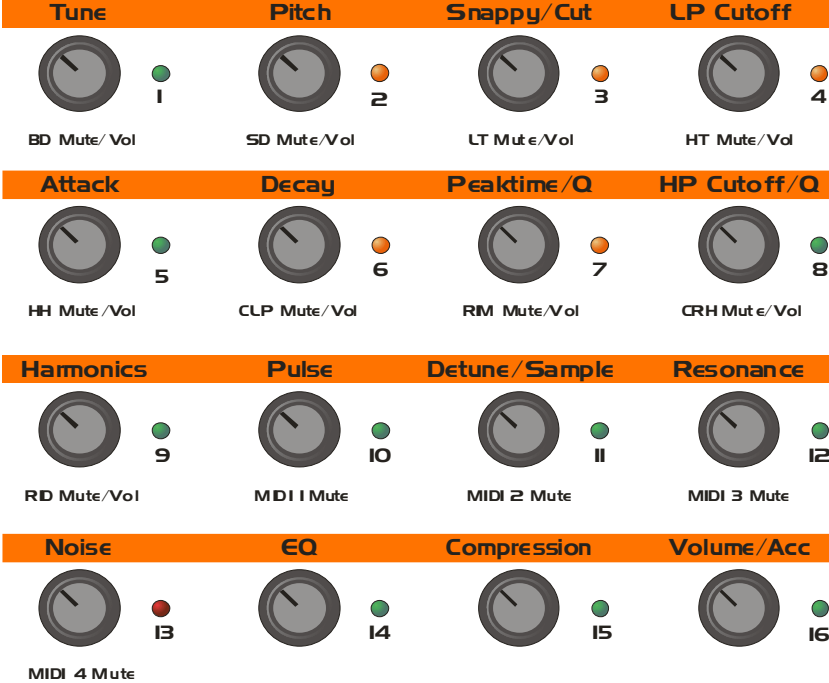

1...16 Encoders and LEDs

Depending on the selected mode, the 16 encoders are assigned to different functions.

The encoders provide a click (press) function which is firmly assigned to the mute function on knob 1..9. When an instrument is muted, the LED next to the encoder flashes red.

In Master Mode, the black printing is active and the encoders are used to adjust the volume of the instruments.

In Edit Mode, the orange indicated printing is active. The LEDs indicate which parameter for the selected instrument is editable by the knobs – they light up green in this case.

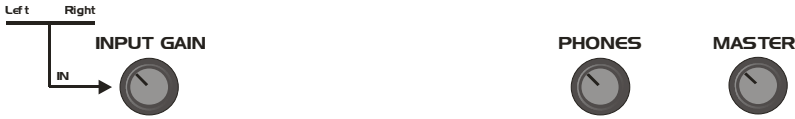

Input Gain

With this knob the input gain of the external filter input can be adjusted.

Phones

This knob controls the phones volume of the front headphone jack.

Master

Note that the master volume is only a “soft control” and works only on the internal CVs and instrument levels and therefore reduces the internal dynamics. For best results, leave this value on maximum level (127).

DATA / TEMPO

XBASE 999
ANALOG DRUM SYNTHESIZER



Data/Tempo

This knob is used for editing of parameters that are chosen by the **(Left)** and **(Right)** cursor buttons. Furthermore, it changes the tempo of the sequencer.

Left/Right

These cursor buttons are used for navigation within the display menus.



Master

This button switches to Master Mode and in the display right down this symbol appears: <Ma>

Edit

This button switches to Edit Mode and in the display right down this symbol appears: <Ed>

Midi

This button switches to Midi Mode and in the display the midi menu appears.

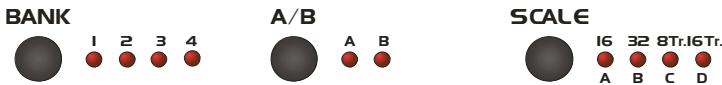

Bank

The bank button cycles between 4 pattern banks.

A/B

This button switches between both alternative patterns A and B.

Scale

With this button you cyclicly select different bar scalings. They are

specificly: 1/16 , 1/32 , 1/8 triplets and 1/16 triplets.
The printed long bars above the step LEDs show the quarter downbeats for the corresponding scales.



Perf
This button activates the Performance Mode of the sequencer.

Patt
This button activates the Pattern Mode of the sequencer.

Song
This button activates the Song Mode.

Write
This button activates - corresponding to the prior selected mode - the Performance Write, the Pattern Write or the Song Write Mode.

Down/Up
These buttons are used for pattern change.

START Start
This button starts the sequencer.

STOP Stop
This button stops the sequencer.

ENTER



Enter

With this button various settings have to be entered.

SHIFT/CANCEL



Shift/Cancel

By pressing this button you can reach the 2nd functions of step buttons 1..16. Also used for cancelling functions.

Scale Bars

The orange or black bars marked with D, C, B and A indicate the quarter downbeats of the selected scale.



Step 1...16 buttons and LEDs

By the 16 step buttons patterns are programmed and selected. Furthermore, in junction with the (Shift/Cancel) button they provide 2nd functions as the orange indicated printing shows.

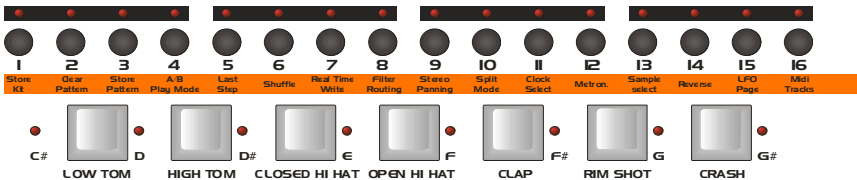

Instrument Keys

These keys are used for triggering and selection of instruments.

Master Mode

The *Master Mode* is used for selection and naming of drum kits and some other global functions. The Master Mode is indicated by a "Ma" down right in the display.

In Master Mode you can change the individual play back volumes of the instruments by the **(Edit Encoders)** (see the printing). The volumes are displayed as bars left down in the display.

```
Init Kit 123 Kick Perf001
■■■■■■■■ Vol127 Ma B120
```

Additionally, you can mute or unmute the instruments by pressing the **(Edit Encoders)**. When an instrument is muted, the corresponding LED flashes red.

By the **(Left)** and **(Right)** encoders you can edit the following parameters. If you have pressed the **(Master Button)** you are currently in the kit selection parameter:

Kit Selection

By the (Data/Tempo) encoder you can choose out of 256 drum kits.

```
Init Kit 223 Kick Perf001
■■■■■■■■ Vol127 Ma B120
```

Beats per Minute

<BPM> <MIDI/039-255>

With this parameter the speed of the sequencer can be edited in beats per minute. The lowest tempo below 39 BPM switches to Midi Clock synchronisation.

```
Init Kit 223 Kick Perf001
BPM 123Name GO! Ma B123
```

Naming of a kit

Move the cursor to **<Name GO!>**. Now press the enter button and the cursor will jump to the kit name's first letter.

```
Init Kit 012 Kick Perf001  
BPM 123Name GO! Ma B123
```

Now you can select the desired letter with the **(Data/Tempo)** Encoder. With the **(Left)** and **(Right)** buttons you can move the cursor to the other letters.

```
Mnit Kit 012 Kick Perf001  
BPM 123Name OK? Ma B123
```

Finally press the enter button, and the display will show:

```
MyFavour 012 Kick Perf001  
Drum kit stored Ma B123
```

Display Contrast

<Contr> <030-110>

Move the cursor to the contrast parameter. Here you can change the contrast of the LCD display.

```
Init Kit 223 Kick Perf001  
Contr037MemPrOFF Ma B123
```

Memory Protect

<MemPr> <on/off>

Move the cursor to the Memory Protect parameter. If this is set to <ON>, no drumkits or patterns can be stored.

```
Init Kit 123 Kick Perf001
Contr037MemPrOFF Ma B123
```

Initialisation of the current kit

<Init> <GO!>

To initialize the whole parameter set of a kit, please choose this item and acknowledge with the **(ENTER)** button.

```
MyOldKit 123 Kick Perf001
Init GO! Ma B123
```

The display shows:

```
MyOldKit 123 Kick Perf001
Are you sure?NO Ma B123
```

Now change this entry to **<YES>** by scrolling the **(DATA/Tempo)** knob.

```
Init Kit 123 Kick Perf001
Are you sure?YES Ma B123
```

After another acknowledge with the **(ENTER)** button the current kit gets initialised.

» **Note:** Only the current edit buffer will be initialized! If you don't store after this, the old kit might get reloaded if you i.e. press the (edit) button again.

If Memory Protect was set to <ON> the function is disrupted. In this case please prior go to Memory Protect and unprotect the current preset.

Edit Mode

In *Edit Mode* all of the instrument parameters are being processed. After pressing the **(Edit)** button you are in Edit Mode and now you can navigate by the **(Left)** und **(Right)** buttons within the different parameter items.

In Edit Mode the **(Edit Encoders)** are assigned to instrument parameters. The LEDs next to the encoders light up green when the parameter is assigned to its knob and available for editing.

The first menu item which is automatically selected when the **(Edit)** button is pressed is:

Selection of a drum kit

With the **(Data/Tempo)** knob you can select 256 different drum kits. One drum kit contains a set of all sound parameters of all instruments (including the filter).

```
Hello999 000Kick Perf001  
Tune 113Pitch030 Ed B123
```

Selection of an instrument

Move the cursor to the instrument parameter. Now select the desired instrument by scrolling the **(Data/Tempo)** encoder.

```
Hello999 000Snar Perf001  
Tune 113Pitch030 Ed B123
```

The second method to select an instrument is by the instrument keys in the Edit Write Mode. Please press the **(Write)** button whilst you are in Edit Mode. Automatically the Bass Drum is selected first, and now you can choose the desired instrument via the instrument keys which is shown in the display.

The following section describes the different instruments and its parameters.

Analogue Sound Engine

Bass Drum

Tune

<Tune> **<000-127>**

This parameter determines the modulation intensity of the pitch envelope. High values lead to the typical "kick in the gut" known from the 909, while lower values softer 808ish kick drums produce, reaching down to tuned basses.

```
Hello999 000Kick Perf001  
Tune 102Pitch030 Ed B123
```

Pitch

<Pitch> **<000-127>**

Changes the basic tone of the bass drum within a far range. This results in very deep basses and reaches up to fairly high tones that might appear not very similar to a bass drum any more.

```
Hello999 000Kick Perf001  
Tune 113Pitch056 Ed B123
```

» **Note:** Please do not mistake tune and pitch of the bass drum. Because in the historical predecessor TR-909 the actual pitch envelope was called tune, the XBASE 999 keeps this tradition only with the bass drum. With all other instruments the tune parameter is called "tune"!

Attack

<Attac> **<000-127>**

In addition to the VCO, a mix from a short noise and pulse signal is generated which together form the attack signal. These part signals can individually be controlled (see lower). The attack parameter controls the intensity of this signal mix in the bass drum.

```
Hello999 000Kick Perf001  
Attac127Decay078 Ed B123
```

Decay

<Decay> **<000-127>**

Controls the decay (release) of the bass drum.

```
Hello999 000Kick Perf001
Attac127Decay078_Ed B123
```

Gate

<Gate> **<000-015>**

Controls the gate time of the attack trigger. It is the time of the attack phase and reaches from 0.5ms to 4.5ms.

On low values the attack sounds clicky, and with higher values the sound is clappier and the tune envelope more intense.

```
Hello999 000Kick Perf001
Gate 001Harmo007_Ed B123
```

» **Note:** *this parameter is assigned to the encoder with printing Peaktime/Q!*

Harmonics

<Harmo> **<000-127>**

Harmonics controls the harmonic overtone spectrum of the bass drum VCO. The basically almost sine-shaped waveform of the VCO can continuously be distorted to a more parabolic waveform. The resulting sound is harder and timpani-like.

```
Hello999 000Kick Perf001
Gate 001Harmo023_Ed B123
```

Pulse

<Pulse> **<000-127>**

Controls the part of the pulse signal in the attack phase signal.

```
Hello999 000Kick Perf001
Pulse067Noise121_Ed B123
```

Noise

<Noise> **<000-127>**

Controls the part of the noise signal in the attack phase signal.

```
Hello999 000Kick Perf001
Pulse067Noise151_Ed B123
```

EQ

<EQ> **<000-007>**

On the output there is a flat filter which can smooth the bass drum. The sound is not changed if the parameter is turned to zero.

```
Hello999 000Kick Perf001
EQ 001Compr000 Ed B123
```

Compress

<Compr> **<000-127>**

Controls the compression of the bass drum VCA envelope. This only affects the decaying part of the loudness envelope. So the effect is rather an expansion of dynamics. Very useful for short and clicky kick drums and for adaption to room size.

```
Hello999 000Kick Perf001
EQ 001Compr095_Ed B123
```

Level

<Level> **<000-127>**

Controls the volume of the bass drum.

```
Hello999 000Kick Perf001
Level127Veloc0N Ed B123
```

» **Note:** *This is the individual volume of the instrument stored along with the current kit, not the global instrument volume which is also controlled in Master Mode (see page 21).*

Velocity

<Veloc> **<ON/OFF>**

If Velocity is set to <ON>, the velocity of a received MIDI note on is processed.

```
Hello999 000Kick Perf001
Level127VelocON_Ed B123
```

Scale

<Scale> **<LIN/SEM>**

Determines if the pitch parameter controls the bass drum pitch in linear fashion (no musical tuning) or in semitones.

```
Hello999 000Kick Perf001
ScaleLINInitOFF_Ed B123
```

» **Note:** *the bass drum oscillator has little tolerances and is not a dedicated analog synthesizer and therefore the tuning may differ a bit from pure musical scalings.*

Initialize

<Init> **<ON/OFF>**

If you set this parameter to <ON>, all sound parameters of the bass drum are immediatly initialised.

```
Hello999 000Kick Perf001
ScaleLINInitON_Ed B123
```

» **Note:** *Only the edit buffer of the bass drum in initialized which means that nothing is stored to user memory! This yields the same for all other instruments.*

Snaredrum

Tune

<Tune> **<000-127>**

Controls the basic tone of the snare drum oscillators.

```
Hello999 000Snar Perf001  
Tune 050Snapp126 Ed B123
```

Snappy

<Snapp> **<000-127>**

Controls the noise part of the snare drum signal.

```
Hello999 000Snar Perf001  
Tune050Snapp122 Ed B123
```

Decay

<Decay> **<000-127>**

Controls the length of noise decay.

```
Hello999 000Snar Perf001  
Decay105Detun000 Ed B123
```

Detune

<Detun> **<000-127>**

This parameter detunes both snare drum oscillators.

```
Hello999 000Snar Perf001  
Decay105Detun000 Ed B123
```

Noise Tune

<NoiTu> **<000-127>**

With this parameter you can control the noise colour. If Noise Tune is turned to 0, the noise signal is shut off. Now you only listen to the oscillators which is suitable for creating analog percussion instruments sounding similar to a rim shot, cow bell or a tom tom.

```
Hello999 000Snar Perf001
NoiTu022Level127 Ed B123
```

Level

<Level> **<000-127>**

Controls the volume of the snare drum.

```
Hello999 000Snar Perf001
NoiTu022Level127 Ed B123
```

» **Note:** *This is the individual volume of the instrument stored along with the current kit, not the global instrument volume which is also controlled in Master Mode (see page 21).*

Velocity

<Veloc> **<ON/OFF>**

If this parameter is set to <ON>, the volume of the snare drum is controlled by the received note on velocity.

```
Hello999 000Snar Perf001
VelocON Init OFF Ed B123
```

Initialize

<Init> **<ON/OFF>**

If this item is set to <ON>, immediatly all snare drum parameters are initialized.

```
Hello999 000Snar Perf001
VelocOFFInit ON Ed B123
```

» **Note:** *Only the edit buffer is initialized, means nothing is stored!*

Low Tom

Tune

<Tune> **<000-127>**

Basic tone of the Low Tom oscillator.

```
Hello999 000LoTo Perf001  
Tune 070Decay044 Ed B123
```

Decay

<Decay> **<000-127>**

Controls the decay time.

```
Hello999 000LoTo Perf001  
Tune 070Decay044 Ed B123
```

Level

<Level> **<000-127>**

Controls the volume of the Low Tom.

```
Hello999 000LoTo Perf001  
Level127VelocOFF Ed B123
```

» **Note:** *This is the individual volume of the instrument stored along with the current kit, not the global instrument volume which is also controlled in Master Mode (see page 21).*

Velocity

<Veloc> **<ON/OFF>**

If this parameter is set to <ON>, the volume of the Low Tom is controlled by the received note on velocity.

```
Hello999 000LoTo Perf001  
Level127VelocOFF Ed B123
```

High Tom

Tune

<Tune> **<000-127>**

Basic tune of the High Tom oscillator, which is higher than that of the Low Tom.

```
Hello999 000HiTo Perf001  
Tune 070Decay126 Ed B123
```

Decay

<Decay> **<000-126>**

Controls the decay time.

```
Hello999 000HiTo Perf001  
Tune 070Decay126 Ed B123
```

Level

<Level> **<000-127>**

Controls the volume of the High Tom.

```
Hello999 000HiTo Perf001  
Level127VelocOFF Ed B123
```

» **Note:** *This is the individual volume of the instrument stored along with the current kit, not the global instrument volume which is also controlled in Master Mode (see page 21).*

Velocity

<Veloc> **<ON/OFF>**

If this parameter is set to <ON>, the volume of the High Tom is controlled by the received note on velocity.

```
Hello999 000HiTo Perf001  
Level127VelocON Ed B123
```

Sample Based Instruments

While Bass Drum, Snare Drum and Tom Toms are generated by pure analog circuitries, the instruments Hi Hat, Clap, Crash and Ride are based on 8 bit samples. Each sample voice runs through an analog VCA with an own envelope.

These VCA envelopes are identical for each voice and can be edited by the parameters Attack, Peak Time and Decay.

The VCA envelope

The **Attack** level parameter determines the attack intensity of the envelope. The lower the attack level is the quicker the sound rises in level. Please note that you need to set **Peak Time** to a value greater than 0 when the **Attack** level is greater than 0. Otherwise the envelope will not rise before decaying, resulting in a weak signal. The **Peak Time** determines the length of the attack phase. The **Decay** parameter determines the length of the decay phase.

If the **Peak Time** parameter is turned to 0, the decay phase starts immediately after triggering of the instrument. You obtain the shortest envelope when you turn **Peak Time** to 0 and adjust a very short decay.

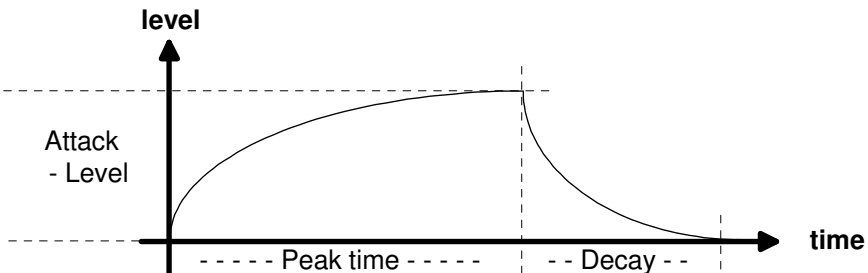

Hi Hat

The Hi Hat instruments have some special circuits build in: after the envelopes there is placed an analog resonant HP/LP filter which can be inserted into the signal path.

Alternatively to the samples white noise can also be used as a sound source which turns this instrument into a true analogue instrument again.

Open and Closed Hi Hat are only playable once at a time, not together.

Tune

<Tune> **<000-127>**

Controls the speed of sample play back. This adjustment affects either the closed as the open Hi Hat!

```
Hello999 000HiHa Perf001
Tune 050CHAtt000 Ed B123
```

» **Note:** *Initial value is 50 which plays the sample back in the same tune as recorded.*

Closed Hi Hat Attack

<CHAtt> **<000-127>**

Controls the attack intensity of the closed Hi Hat. High values may be used for instance to slowly fade in a reversely played sample.

```
Hello999 000HiHa Perf001
Tune 050CHAtt008 Ed B123
```

» **Note:** *You have to make **Peak Time** also greater than 0 when **Attack** is greater than 0. Otherwise the envelope will not reach the highest peak before the decay sets in, resulting in a weak signal.*

Closed Hi Hat Decay

<CHDec> <000-127>

Controls the length of the decay phase.

```
Hello999 000HiHa Perf001  
CHDec007CHPkt002 Ed B123
```

Closed Hi Hat Peak Time

<CHPkt> <000-127>

Controls how long the Closed Hi Hat envelope remains open before the decaying phase starts. When the Peak Time value is great, you can hear the changes in attack level very clearly. A change on decay time might then be only recognizeable very little because the sample may be played back already when decay phase sets in. This is also dependend on the playback speed (Tune).

```
Hello999 000HiHa Perf001  
CHDec007CHPkt009 Ed B123
```

Open Hi Hat Attack

<OHAtt> <000-127>

Controls the attack intensity of the Open Hi Hat. High values may be used for instance to slowly fade in a reversely played sample.

```
Hello999 000HiHa Perf001  
CHAtt000OHDec016 Ed B123
```

Open Hi Hat Decay

<OHDec> <000-127>

Controls the length of the decay phase.

```
Hello999 000HiHa Perf001  
CHAtt000OHDec106 Ed B123
```

Open Hi Hat Peak Time

<OHPkT> <000-127>

Controls how long the Open Hi Hat envelope remains open before starting the decaying phase.

```
Hello999 000HiHa Perf001
OHPk+001SmpleS06 Ed B123
```

Hi Hat Sample Select

<Smple> <909/808/CR7/JMX/S05-S31>

You can choose from 31 samples total. The hi hat sample selection affects either the open as the closed hi hat.

```
Hello999 000HiHa Perf001
OHPk+000SmpleCR7 Ed B123
```

» **Note:** The first four samples are fixed and the rest of them can be reloaded by the user by MIDI download. For this purpose Jomox provides a sample editor tool that can be downloaded for free on the Jomox website www.jomox.com

The fixed samples are

909: TR909 Hi Hat

808: TR808 Hi Hat

CR7: CR78 Hi Hat

JMX: acoustic Jomox Hi Hat

Reverse Play

<Revr> <ON/OFF>

ON - The samples of Closed and Open Hihat are played back reverse.

OFF - The samples ar played back normal.

```
Hello999 000HiHa Perf001
Revr+OFFSourcNOR Ed B123
```

Source

<Sourc> <NOR/FIL/NOI>

The source parameter decides which signal is to be routed to the HH filter and VCA.

```
Hello999 000HiHa Perf001
RevrSOFFSourcNOR Ed B123
```

At your choice:

NOR (Normal) The Hi Hat samples go directly into the VCA and bypass the filter section.

FIL (Filtered) The Hi Hat samples go first into the HH filter and then into the VCA.

NOI (Noise) Instead of samples white noise is led into the filter and then goes into the VCA.

Low Pass Filter Cutoff

<CutLP> <000-127>

On a value of <127> the low pass filter is maximum opened. At lower values more high frequencies are filtered away (more dull). Both filters form a band pass. Tweak both part filters to yield your desired result.

```
Hello999 000HiHa Perf001
CutLP079CutHP013 Ed B123
```

» **Note:** The hi hat filter only works when parameter **Source** has been set to either **FIL** (Sample -> Filter) or **NOI** (Noise -> Filter).

High Pass Filter Cutoff

<CutHP> <000-127>

<127> means that almost all low frequencies are filtered. If you lower this value, low frequencies become louder and the tone stronger. A high pass filter filters the low frequencies away.

```
Hello999 000HiHa Perf001
CutLP079CutHP013 Ed B123
```

» **Note:** Both filters form a bandpass. Tweak the part bands to get your desired result.

If Cut LP = <127> and Cut HP = <000>, the filter has its largest bandwidth. This filter, however, is optimized for hi hat sounds and has therefore a limited bandwidth that cuts about above 1khz even with maximum adjustment.

Filter Resonance

<Reson> <000-127>

This parameter controls the resonance of the resulting band pass filter. <000> means that the filter doesn't have resonance.

```
Hello999 000HiHa Perf001
Reson023Level127 Ed B123
```

Level

<Level> <000-127>

Controls the volume of the hi hat.

```
Hello999 000HiHa Perf001
Reson023Level127 Ed B123
```

» **Note:** This is the individual volume of the instrument stored along with the current kit, not the global instrument volume which is also controlled in Master Mode (see page 21).

Velocity

<Veloc> **<ON/OFF>**

If this parameter is set to <ON>, the volume of the hi hat is controlled by the received note on velocity.

```
Hello999 000HiHa Perf001
VelocON  Init OFF Ed B123
```

Initialization

<Init> **<ON/OFF>**

If this item is set to <ON>, immediatly all parameters are initialized.

```
Hello999 000HiHa Perf001
VelocOFF Init ON Ed B123
```

Clap, Rim, Crash and Ride

The parameter sets of Clap, Rim, Crash and Ride are equal. For this reason, the parameters are described only for the Clap section as an example.

Tune

<Tune> **<000-127>**

Controls the tune or better the speed of Clap/Rim/Crash/Ride sample play back.

```
Hello999 000Clap Perf001
Tune 050 Attac000 Ed B123
```

» **Note:** *Initial value is 50 which plays the sample back in the same tune as recorded.*

Attack

<Attac> **<000-127>**

Controls the attack intensity of the Clap/Rim/Crash/Ride envelope. High values may be used for instance to slowly fade in a reversely played sample.

```
Hello999 000Clap Perf001
Tune 050 Attac000 Ed B123
```

» **Note:** You have to make **Peak Time** also greater than 0 when **Attack** is greater than 0. Otherwise the envelope will not reach the highest peak before the decay sets in, resulting in a weak signal.

Decay

<Decay> **<000-127>**

Controls the length of the decay phase.

```
Hello999 000Clap Perf001
Decay050PeakT000 Ed B123
```

Peaktime

<PeakT> **<000-127>**

Controls how long the Clap/Rim/Crash/Ride envelope remains open before starting the decaying phase.

Hiermit bestimmen Sie, wie lang die Clap Hüllkurve offen bleibt, bevor die Decay Phase beginnt.

```
Hello999 000Clap Perf001
Decay050PeakT009 Ed B123
```

» **Note:** When the **Peak Time** value is high, you can hear the changes in attack level very clearly. A change of decay time is then only recognizable very little because the sample may be played back already when decay phase sets in. This is also dependent on the playback speed (**Tune**).

Reverse Play

<Revr> <ON/OFF>

ON - The samples of Clap/Rim/Crash/Ride are played back reverse.

OFF - The samples are played back normal.

```
Hello999 000Clap Perf001
RevrOFFSmplS11 Ed B123
```

Sample Selection

<Smpl> <909/808/CR7/JMX/S05-S31>

You can choose from 31 samples total.

```
Hello999 000Clap Perf001
RevrOFFSmplS11 Ed B123
```

» **Note:** The first four samples are fixed and the rest of them can be reloaded by the user. Jomox provides a sample editor tool that can be downloaded free of charge at www.jomox.com

Please find the fixed samples in the following table:

Smpl\Instr.	Clap	Rimshot	Crash	Ride
909 (TR909)	909 Clap	909 Rim	909 Crash	909 Ride
808 (TR808)	808 Clap	808 Rim	808 Cym.	808 Cowb.
CR7 (CR78)	Metallic Cym.	Cowbell	Tambourine	Guiro
JMX (Jomox)	Hand Clap	Rimshot	Crash	Ride

Level

<Level> <000-127>

Controls the volume of the sample.

```
Hello999 000Clap Perf001
Level127VelocON Ed B123
```

» **Note:** This is the individual volume of the instrument stored along with the current kit, not the global instrument volume which is also controlled in Master Mode (see page 21).

Velocity

<Veloc> <ON/OFF>

If this parameter is set to <ON>, the volume of the Clap/Rim/Crash/Ride is controlled by the received note on velocity.

```
Hello999 000Clap Perf001
Level127VelocON Ed B123
```

Initialize

<Init> <ON/OFF>

If this item is set to <ON>, immediatly all parameters are initialized.

```
Hello999 000Clap Perf001
Init Off Ed B123
```

The LFOs

Note: The LFOs can only to be reached over the menu, not by assigned knobs. Move the cursor to the instrument selection and turn the **(data)** knob until <LFOs> appears. Now you can navigate all parameters with the cursor and change them by **(data)** encoder.

The XBASE 999 contains 2 digital LFOs (Low Frequency Oscillators). With these you can modulate the pitch of all instruments. Furthermore, you can modulate the filter cutoffs of the Hi Hat filter and the global stereo filter.

LFO1 Waveform

<L1Wav> <Sup/Sdo/TRI/RCT>

This parameter selects the waveform for LFO1.

```
Hello999 000LFOs Perf001
L1WavTRIL1DesFCL Ed B123
```

Following waveforms are available:

Sup - *Rising sawtooth*
Sdo - *Falling sawtooth*
Tri - *Triangle*
RCT - *Rectangle*

LFO1 Destination

<L1Des> <BDt/SDt/LTt/HTt/HHt/FIL/CPt/RMt/CRt/RDt>

Selects the parameter which is modulated by LFO1. You can choose between:

```
Hello999 000LFOs Perf001
L1WavTRIL1DesFCL Ed B123
```

BDt *Bass Drum Tune*
SDt *Snare Drum Tune*
LTt *Lo Tom Tune*
HTt *Hi Tom Tune*
HHt *Hi Hat Tune*
HHF *Hi Hat Filter Cutoff*

CPt *Clap Tune*
RMt *Rimshot Tune*
CRt *Crash Tune*
RDt *Ride Tune*
FCL *Global Filter Cutoff left*
FCR *Global Filter Cutoff right*

LFO1 Intensity

<L1Int> <000-127>

Controls the modulation intensity of LFO 1. If <L1Int> is set to <000>, LFO 1 is shut off.

```
Hello999 000LFOs Perf001
L1Int000L1Rat024 Ed B123
```

LFO1 Rate

<L1Rat> <000-127>

Controls the speed of LFO1. The absolute speed is also dependent from the **BPM** parameter in **Master Mode** because the LFO is driven by the main sequencer.

```
Hello999 000LFOs Perf001
L1Int000L1Rat024 Ed B123
```

LFO2 Waveform

<L2Wav> <Sup/Sdo/TRI/RCT>

This parameter selects the waveform for LFO2.

```
Hello999 000LFOs Perf001
L2WavTRIL2DesFCL Ed B123
```

Following waveforms are available:

- Sup** - *Rising sawtooth*
- Sdo** - *Falling sawtooth*
- Tri** - *Triangle*
- RCT** - *Rectangle*

LFO2 Destination

<L2Des> <BDt/SDt/LTt/HTt>

Selects the parameter which is modulated by LFO2. You can choose between:

```
Hello999 000LFOs Perf001  
L2MavTRIL2DesFCL Ed B123
```

BDt Bassdrum Tune
SDt Snaredrum Tune
LTt Lo Tom Tune

HTt Hi Tom Tune
FCL Global Filter Cutoff left
FCR Global Filter Cutoff right

LFO2 Intensity

<L2Int> <000-127>

Controls the modulation intensity of LFO2. If <L2Int> is set to <000>, LFO2 is shut off.

```
Hello999 000LFOs Perf001  
L2Int+010L2Rat+039 Ed B123
```

LFO2 Rate

<L2Rat> <000-127>

Controls the speed of LFO2. The absolute speed is also dependent from the BPM parameter in Master Mode because the LFO is driven by the main sequencer.

```
Hello999 000LFOs Perf001  
L2Int+010L2Rat+039 Ed B123
```

Synchronization of LFO1
<L1Syn> <ON/OFF>

If this parameter is set to <ON>, LFO1's wave is restarted by the instrument's trigger assigned to as modulation destination. If set to <OFF>, no synchronization occurs.

```
Hello999 000LFOs Perf001  
L1SynON L2SynOFF Ed B123
```

Synchronization of LFO2
<L2Syn> <ON/OFF>

If this parameter is set to <ON>, LFO2's wave is restarted by the instrument's trigger assigned to as modulation destination. If set to <OFF>, no synchronization occurs.

```
Hello999 000LFOs Perf001  
L1SynOFFL2SynON Ed B123
```

The Filter

Both filters are identical and can be used as stereo filters or as 2 independent single filters or as feedbacked multi-resonator.

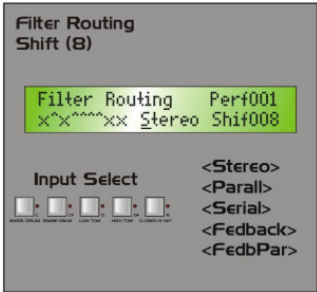
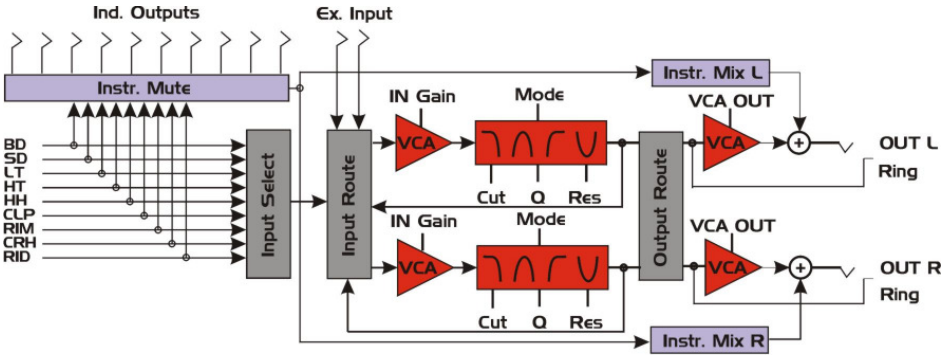

The filter always works in parallel to the rest of the audio engine and is always present at the stereo mix (see picture).

Either external signals or the internal instruments can be fed into the filter by means of the programmable router. There are also programmable feedback tracks from the output to the input. All adjustments are storeable.

The filter gating is dynamical to avoid from unwanted noise or whistling signals. To avoid filter related noise by 100% is almost

impossible because the filter is almost the only source for noise and it is always mixed into the output.

In case the filter should disturb:

A click on encoder 16 mutes the filter out by the VCA Out in the stereo mix.

The following filter editings and modes are stored along with a Drum Kit together with the other instruments.

» **Note:** You can find more about filter setups regarding connections of both filters and the instrument input settings at **2nd Functions** under **Filter Routing** (Shift) + (Step 8).

More about the filter in Pattern Mode with its own sequencer you can learn at **Pattern Mode / The Filter in Pattern Mode**.

Cutoff Left

<CutL> <000-127>

Controls the cutoff frequency of the left filter.

```
Hello999 000Filt+ Perf001
CutL075 CutR029 Ed B123
```

Cutoff Right

<CutR> <000-127>

Controls the cutoff frequency of the right filter.

```
Hello999 000Filt+ Perf001
CutL075 CutR029 Ed B123
```

Q Left

<Q_L> <000-127>

Controls the Q (quality or bandwidth) of the left filter. The higher the Q, the more narrow-banded or peaky the filter is at its cutoff.

```
Hello999 000Filt+ Perf001
Q_L 101 Q_R 127 Ed B123
```

» **Note:** If **Resonance** is set to <000>, a **Q** of <127> will make the filter extremely narrow banded, but will never bring it to self-oscillation though.

Q Right

<Q_R> <000-127>

Controls the Q (quality or bandwidth) of the right filter. The higher the Q, the more narrow-banded or sharp the filter is at its cutoff.

```
Hello999 000Filt Perf001
Q_L 101 Q_R 127 Ed B123
```

Resonance Left

<Res_L> <000-127>

Controls the resonance of the left filter.

```
Hello999 000Filt Perf001
ResL000 ResR000 Ed B123
```

» **Note:** *The filter only starts to self-oscillate if Q was adjusted to a value equal or greater than about <060> (depending on some analog tolerances). If Resonance is high, the Q value will also control the depth of resonance.*

Resonance Right

<Res_R> <000-127>

Controls the resonance of the right filter.

```
Hello999 000Filt Perf001
ResL000 ResR000 Ed B123
```

Filter Mode Left

<MdeL> <LP/HP/BP/Not>

Selects the filter mode of the left filter. You can choose between following types of filters:

Low Pass, High Pass, Band Pass and Notch.

```
Hello999 000Filt Perf001
MdeL_LP MdeR HP Ed B123
```

Filter Mode Right

<MdeR> <LP/HP/BP/Not>

Selects the filter mode of the left filter. You can choose between following types of filters:

Low Pass, High Pass, Band Pass and Notch.

```
Hello999 000Filt Perf001
MdeL LP MdeR_BP Ed B123
```

Filter Gain

<Gain> <000-127>

Controls the input gain of the external stereo input. This also controls the input gain for the internal instruments.

```
Hello999 000Filt Perf001
Gain 127VCA0u127 Ed B123
```

Fiter VCA Out

<VCAOu> <000-127>

Controls the output volume of the filter being mixed into the stereo mix output. The VCA mixes the filter signal to the internal instruments in the stereo mix.

```
Hello999 000Filt Perf001
Gain 127VCA0u127 Ed B123
```

» **Note:** *The filter R/L output signal is also split out at the ring of the ¼" stereo jacks, but before the VCA out which is adjusted here – means always with full level. So if you want to process the pure filter signal without stereo mix, you should use an insert cable and split out the ring signal into a separate mixer channel.*

You should also note that the usage of stereo (balanced) cables together with balanced inputs of mixers may cause some problems, because the filtered signal is always connected to one phase of the balanced input. Then the passing filter never can be muted, because it is led out before the final VCA. This might result in instruments that appear not mutable because the filtered part is always present. For this, you should always use mono plugs for internal use of the filter because they short the annoying filter output (this is made for shorting).

Midi Mode

Here you can find some important parameters for the Midi communication.

Receive Channel

<RcvCh> <001-016>

Selects the Midi receive channel 1..16.

```
RevCh001T xmCh001
BdumpGO!BloadGO! ..
```

Transmit Channel

<TxCh> <001-016>

Selects the Midi transmit channel 1..16.

```
RevCh001T xmCh001
BdumpGO!BloadGO! ..
```

Bulk Dump

<Bdump> <GO!>

With this function you can transmit all patterns and drumkits into an external midi device by a Sysex bulk dump.

```
RevCh001T xmCh001
BdumpGO!BloadGO! ..
```

» **Note:** *Samples are not sent!*

This can be e.g. a sequencer or a computer. If you have activated the record function on your receiving device, please press **(ENTER)** to start the transmission.

During transmission of the bulk dump the display shows the following:

```
RevCh001T xmCh001
BdumpBS/BloadGO! ..
```

About a minute later the unit will inform you that the dump is finished:

```
Operation Complete
Midi Dump executed  _
```

Bulk Load

<Blood> <GO!>

With this function you can receive patterns and drum kits from another midi device, e.g. a computer running the Jomox SysEx dumper tool.

```
RecvCh001TxmCh001
BdumpGO!BloodGO!  _
```

Press **(Enter)** to enable the reception of an XBASE 999 compatible Midi dump. The display shows <RDY> and the XBASE 999 waits until it receives the correct bulk dump.

```
RecvCh001TxmCh001
BdumpGO!BloodRDY'  _
```

» **Note:** Now you can start the Sysex dump on your external device, e.g. computer or other MIDI device.

The progress of dump receipt is displayed by step and knob LEDs which light up in a row after a certain number of received bytes.

Transmit Program Change

<TxPgch> <ON/OFF>

This parameter selects if the program change command is sent on a drum kit change or not.

```
RecvCh001TxmCh001
TxPrgOFFTxCtrOFF  _
```

Transmit MIDI Controllers

<TxCtr> <ON/OFF>

If this item is set to <ON> Midi Control Changes (CCs) are sent if you change instrument parameters.

```
RecvCh001TxmCh001
TxPrgOFFTxCtrOFF
```

» **Note:** Please find the list of CCs in the midi implementation table in the appendix.

Transmit MIDI Note Triggers

<TxTrg> <ON/OFF>

If this parameter is set to <ON>, the firmly assigned Midi notes of the instruments are sent as 5ms long note triggers.

```
RecvCh001TxmCh001
TxTrgOFFTxClkOFF
```

» **Note:** This adjustment has no effect to the programmable Midi Tracks as described in Chapter 2nd Function: (16) Midi Tracks. Below here is the list of the fixed note numbers that can also be found in the appendix. Please note that the assignment of these fixed note triggers cannot be edited.

XBASE 999 Instr.	Midi Instr.	Note No.	Note
Kick Drum	Bass/Kick Drum	36	C1
Snare Drum	Electric Snare	40	E1
Lo Tom	Low Floor Tom	41	F1
Hi Tom	High Floor Tom	43	G1
Closed Hi Hat	Closed Hi Hat	42	F#1
Open Hi Hat	Open Hi Hat	46	A#1
Clap	Clap	39	D#1
Rim Shot	RimShot	37	C#2
Crash	Crash	49	D2
Ride	Ride	52	E2

Transmit MIDI Clock

<TxClk> <ON/OFF>

If this parameter is set to <ON>, MIDI clock gets sent at the MIDI out to synchronize hooked up Midi devices in slave mode.

```
RecvCh001TxmCh001  
TxTrg0FFTxClkON
```

The Sequencer

Perform Mode

Press the **(PERF)** button to enter the Perform Mode. This mode is used for selection, playing back and programming of patterns. Opposing to the Pattern Mode you can't record or play back sound changes within a pattern. You can only hear one sound for each instrument. But you can edit the sound parameters in realtime during the sequencer is running.

Selection of Drum Kits

If you were not currently editing a parameter in Edit Mode, you can use the **(Data/Tempo)** encoder to select a drum kit. If you are currently in a parameter menu, press the **(Edit)** or **(Master)** button to let the cursor jump to the drum kit selection – or press and hold (until autorepeat) the **(Left)** cursor button to move the cursor all to the left. There are 256 drum kits (000-255).

Perform Play Mode

A maximum of 64 patterns are storeable in memory which are organized in 4 banks 16 pattern each. You can switch between the banks by pressing the **(Bank)** button. The currently selected bank is shown by the respective **(Bank LED)**. By the 16 **(Step)** buttons you can choose a pattern within the current bank. Alternatively, you can use the **(Up)/(Down)** buttons for a bank independent selection of patterns. The selected **(Step LED)** lights up and the display shows:

```
>Hello999 000Kick Perf012  
Tune 102Pitch030 Ed B123
```

Pattern as bank changes can be performed whilst the sequencer is running. The changes are only taken on wrap-around to the new

pattern.

By pressing the **(Start)** button you start the sequencer. With the **(Stop)** button you stop it.

» **Note:** Does the sequencer not run? Check the clock source settings!
(Should be set to <INT>)

A/B Pattern

Each pattern consists actually from 32 steps.

They are organized in 2 x 16 steps though, called A and B pattern.

A/B



Therefore it is possible to create 2 variations of a pattern that can be easily toggled by pressing the **(A/B)** button which is shown by the A/B LEDs. There is also an alternating play mode to let you create a two bar pattern (see **A/B Playmode**). In this mode, the currently played LED is lit up steadily while the LED selected for editing is blinking.

After clearing of the pattern (see 2nd functions (2) clear pattern), there is an automatic copy function from part A to B.

Every editing that is made in pattern A is automatically copied to pattern B unless the A/B switch has been pressed for the first time after clearing.

This is useful for creating a basic drum beat, and after completion just switch to part B and make little variations of part A.

This internal copy function is regardless of the A/B playmode.

Perform Write Mode

This mode is used for programming of patterns and for editing of instrument parameters.

To enter the Perform Write Mode please press the **(Perf)** button (in case you were not in Perform Mode already) and press the **(Write)** button.

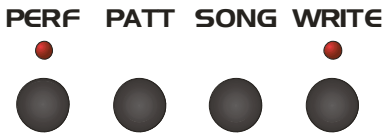

Programming of Patterns in Perform Write Mode

Basically, patterns can be programmed in 2 different ways. The first choice is to use the step sequencer where each 16th is assigned to a step button. When the sequencer is running, a green LED shows the currently played position. The second choice is to record it live (see Realtime Write).

This section describes the first option. First you should define the scale and length of the pattern as this defines the resulting measure.

Scale



The **(Scale)** button switches between

- A 16th (Last Step=16)
- B 32th (Last Step=32) A/B pattern double time
- C 8th Triplets (Last Step=12)
- D 16th Triplets (Last Step=24) A/B pattern double time

The **(Scale Bars)** that are printed above the **(Step LEDs)** indicate where the quarter downbeats of the selected scale are.

The **Scale** function also changes automatically the functions **A/B Playmode** and **Last Step**.

Please note that Scale C and D still form a 4/4 measure, only the beats between the downbeats are triplets.

The initialized pattern has following structure:

Scale:A(16th) Last Step:16 A/B Playmode:fix

That makes it a 4/4 measure with 16th notes.

» **Tip:** If you have selected scale B 32th, the A/B Playmode is automatically set to alternating (see P.) You have now 32 steps total in a playtime of a regular 16th pattern, and the higher and lower 16 steps of the 32 steps can be selected by the A/B button.

Selecting Instruments

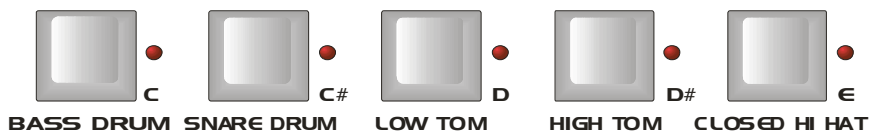

With the **(Instrument)** keys you can select the instrument track to be edited. Each instrument has its own track and its own step programming. Of course you can switch between these whilst the sequencer is running. The 16 **(Step)** LEDs above the buttons indicate on which steps the selected instrument is played (the playing LEDs light up red).

Setting or Clearing Steps – Programming Beats

Each **(Step)** button is assigned to a rhythm note. Set or clear the rhythmic notes in your selected instrument track by pressing the desired **(Step)** buttons.

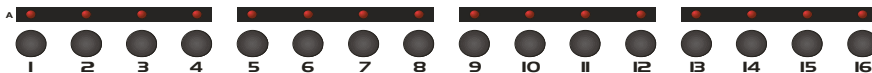

The running green LED shows which note is currently played by the sequencer. The fixed red 16 LEDs show if the note is played at this pointer or not.

If you have selected for instance 16th scale (A), so every **(Step)** button will resemble a 16th note. 16 steps make it a 4/4 measure. Other measures like e.g. $\frac{3}{4}$ are also possible, you have to change the number of steps to 12 in this case (see Last Step).

Editing of Instrument Parameters

First make sure that you are in Edit Mode. This is displayed by an <Ed> in the LCD.

In case not, press the **(Edit)** button and press the **(Write)** button.

```
Hello999 000Kick Perf001
Tune 102Pitch030 Ed B123
```

Now the **(Edit Encoders)** are assigned to sound parameters of the selected instrument. The LEDs next to the 16 **(Edit Encoders)** indicate by green light if the respective **(Edit Encoder)** has a parameter assigned to. When you select another instrument by pressing one of the **(Instrument)** keys, the assignment of the **(Edit Encoders)** changes immediatly. If you edit a parameter, the display will show the changed value and jump to the parameter position in

the edit menu. To hear what you are doing, you can either work with a running sequencer or go back to Perform Play Mode by pressing the **(Write)** button again and trigger the **(Instruments)** keys of the last selection manually. The selected instrument edit region will stay in play mode unless you re-establish the Write Mode which automatically selects bass drum first.

So if you want to edit a desired instrument in Perform Play mode, you have to change quickly into Write mode, select the **(Instrument)** key and go back to play mode by pressing **(Write)** again. Now you can play and tweak at the same time.

Usage of Drum Kits

When you are editing an instrument, you only change a temporary memory, the so-called "edit buffer". In this memory block all sound parameters are managed. In order not to have to make your effortfull edited instruments from scratch again each time, you can store the edit buffer as a Drum Kit.

The XBASE 999 contains 256 memory locations for drum kits. You can recall a drum kit by scrolling the (Data/Tempo) knob.

DATA / TEMPO



```
Hello999 000Kick Perf001  
Tune 102Pitch030 Ed B123
```

This copies the selected preset memory into the edit buffer. If you are not in the highest (leftmost) cursor position, press the left cursor button to reach the leftmost cursor position where preset selection takes place. Pressing the **(Edit)** button yields the same result.

» **Note:** *If you select another drum kit, the old sound memories in the edit buffer are overwritten! Don't forget to store your drum kit if you like to keep it! (See Kit Store P.)*

Muting Instruments



At any time and in any mode, you can mute the instruments by clicking on one of the displayed encoders 1-9. When the instrument is muted, the corresponding LEDs blinks red.

» **Note:** The filter runs aside of the audio engine and is mixed into the stereo bus. Thus it may occur on some filter setups that the filtered instruments are still in the mix bus apparent although they are muted. Now they can be muted by encoder 16 (filter mute) or by different filter programming (see The Filter page 47).

It has been purposefully made like this because you can free decide if you want a filtered, pure, mixed or even no signal. You can also handle the filter as an own instrument (For instance for resonating basses). The individual outputs are not affected by this since the signal is split out before the filter which only works in the stereo mix bus.

Pattern Mode

The Pattern Mode - like the Perform Mode – is used for programming and playing back of rhythmic patterns, only difference is that every sound parameter can be stored and played back for each step individually. You can think of the pattern mode like a chained row of 16 drum kits that are selected and played back in realtime.

Pattern Play Mode

Works the same like the Perform Play Mode (see Perform Play Mode)

Pattern Write Mode

You can reach the Pattern Write Mode by pressing **(Write)** whilst you are in pattern mode.

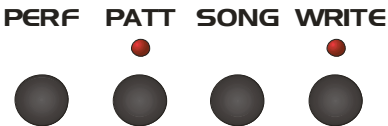

Individual Step Edit

With this function you are able to create a different sound programming for each step of an instrument track. You can either select one or more steps in this mode.

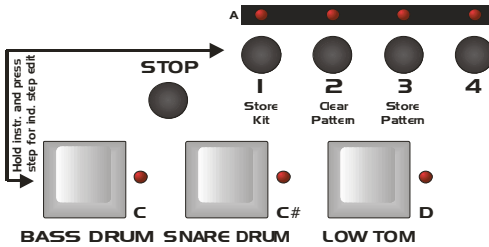

To enter the Individual Step Edit Mode for steps, press and hold the desired **(Instrument)** key and press the desired **(Step)** button(s) at the same time. The selected step LEDs start to flash indicating the Individual Step Edit Mode. The instrument tracks can be switched as used, and the Individual Step Edit steps remain until the Write Mode is left which automatically resets the Individual Step Edit steps.

Now you can edit or select drum kits in the selected steps by the (Edit Encoders) until you are satisfied.

All steps that are in Individual Step Edit Mode access to the edit buffer (see p. Usage of Drum Kits). So if you change that edit buffer by selecting another drum kit, the edit buffer gets automatically copied into the selected steps when the running sequencer LED comes across this step.

If a bass drum track, for instance, has selected step 1 and 9 in the Individual Step Edit Mode, only on these steps the sound will change to the scrolled drum kit and the other remain unchanged. Also tweakings by the **(Edit Encoders)** only affect the selected steps.

If you are ready with your editings, leave the Individual Step Edit Mode by holding the **(Instrument)** key and pressing the **(Step)**

button again. The step LED stops to flash and the step is locked again. If you have selected a number of steps, it might be easier to leave the Individual Step Edit Mode by pressing **(Write)** which resets all steps together to the locked state.

Track Record Mode

With the Pattern Track Record function you can edit all steps of an instrument track in a running pattern at the same time. To activate this function, hold the **(Instrument)** key and press the **(Write)** button at the same time which is indicated by a flashing write LED.



If you now turn the knobs of the selected instrument, all the programmed steps of this track are overwritten with the edits you make. If you want to record dynamic sound scapes, you have to leave the Write Mode by pressing **(Write)** quickly after a successful pattern loop, because on the next loop all steps would be overwritten again.

The Filter in Pattern Mode

In pattern write mode the filter is run by a step sequencer. There are 4 tracks, and each track controls one parameter of the filter. They are in detail: Cutoff, Q, Resonance, and Volume.

The selection of left and right filter is made by pressing the filter key again: For the left filter (upper row) the filter key LED lights up firmly, and for the right filter (lower row) the LED blinks.

Each of the 16 (**Edit Encoders**) corresponds to a step. When the sequencer runs, the 16 red encoder LEDs run also to indicate the sequencer position. With the (**Left**) and (**Right**) cursor buttons you can switch between the parameter tracks given as Cutoff, Q, Resonance and Volume (Only exception: these last 2 tracks are split up into Filter In Gain (upper) and VCA Out (lower) and process both filters equally).

A letter right next to the track bars indicates which parameter is currently selected.

- C** Cutoff
- Q** Quality
- R** Resonance
- V** VCA



With the (**Step**) buttons you can select at which steps parameters are to be changed. As soon as the selected (**Step**) LED lights up, at the corresponding place in the LCD a bar is displayed and its height shows the value. Steps not set are displayed as an "x" in the LCD. The upper row of bars corresponds to the left and the lower to the right filter. If you turn the respective (**Edit Encoders**) 1..16, you can change these values if a step was set.

Please note that if you want to process the internal instruments by the filter, you have to edit the filter routing beforehand (See p. 2nd Functions 8 Filter Routing).

There you can also edit the wiring between both filters. But these

setups are only stored in Perform Mode as a Drum Kit. So you can change the “wiring” of the filter whilst in Pattern Mode by scrolling Perform Drum Kits by the **(data)** encoder.

Furthermore, the editings of filter mode, that is the configuration to either lowpass, highpass, bandpass or notch, are also only to recall by the bypassing Perform Drum Kit. The same yields for the LFOs which can only be programmed in Perform Mode.

So you should first make the filter configuration and eventual LFO modulations in Perform Mode, store them as a drum kit and then switch to Pattern Mode to make the step programming.

The chance of this method is that you can simply recall different filter configurations by scrolling the data encoder through other perform drum kits whilst the filter sequence is running in Pattern Mode.

If you only want to listen to the filtered signal, you have to mute the desired instrument from direct signal path by pressing one of the instrument encoders 1..9.

Song Mode

Song Mode is a function that is of higher order than the Perform or Pattern mode and can be used with both of them.

You activate it by pressing the (Song) button – the Song LED lights up - and leave it by pressing this button again.

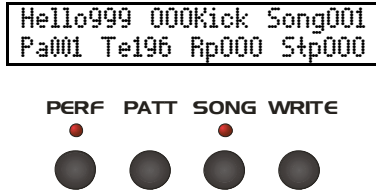

In Song Mode single patterns are arranged to playlists. This is made by so-called Song Steps that are similar to a script which is calling high order functions. In a Song Step the following information can be stored:

- **"Name XXX "** - The selection of the currently played Perform Kit (only active in Perform Mode)
- **<PaXXX>** - The selection of the currently played pattern.
- **<TeXXX>** - The tempo of the currently played pattern.
- **<RpXXX>** - The number of repetitions of the actual pattern.
- **<StpXXX>** - The number of the current Song Step in the playlist.

The song always starts with step 0. If you press the start button, the song plays the list step by step in ascending order and executes the programmed instructions.

On playback the repetitions (Repeats) are counted down and when the number jumps to 0, the next Song Step will be loaded.

The maximum number of repetitions in a Song Step is 254. One repeat always plays back a full pattern, that means 2 bars if it is A/B alternating programmed or one single bar if it is wether on A or B programmed.

The maximum number of Song Steps is limited to 255.

You can program up to 20 different songs which you can select by the **(Up)** / **(Down)** buttons. The Song No. is displayed on the right side in the LCD display.

```
Init Kit 021Kick Song001  
Pa001 Te120 Rp000 Stp000
```

You can program Song Steps either manually or in real time.

Song Mode Manual Programming

By means of the Cursor buttons you can select the different parameters of a Song Step and change them with the data encoder.

Although the editing is read out in realtime and can be made during playback, it may happen that the list jumps to the next Song Step if you i.e. lower the number of repeats whilst it counts down.

Thus, for manual editing the sequencer should be stopped. To store the value into the Song Step memory, the **(Write)** button has to be pressed beforehand.

In Song Mode the write LED is always flashing in order to indicate that you are in Song Mode.

The Pattern Write Mode is not affected by this and can even be used in parallel with some limitations...for instance to edit single instruments by encoders during live performance while the song is playing.

An example: If you want to repeat say pattern "6" 8 times, you set the cursor to **Pa** and press **(Write)** - the LED blinks.

Now turn **(Data)** encoder to 6. You could also use step button 6 to select the pattern – it has the same function in Song Mode.

```
>Hello999 000Kick Song001  
Pa006 Te120 Rp008 Stp000
```

Then you move the cursor to **Rp** and change the number of repetitions to 008.

You have to press **(Write)** again to leave the write mode in order not to change the programmed settings.

Move the cursor to **Stp** and select the next Song Step. Now maybe you want to repeat pattern "2" 4 times and change the tempo to 128 BPM and use another kit. Go ahead like above described, and press **(Write)** before you edit the desired parameter.

```
Init Kit 002Kick Song001  
Pa001 Te128 Rp004 Stp001
```

As next Song Step you program the end. Increase **Stp** to 2, and program **Rp** to 0. The number of 0 repetitions defines the song end which is displayed as <FIN>.

```
Init Kit 002Kick Song001  
Pa001 Te128 Rp000 StpFIN
```

After editing, please don't forget to leave the Write Mode. Now press **(Start)**, and the song gets played back. On reaching of Song Step 2 the song is finished.

Song Mode Realtime Programming

You can also record songs in realtime and edit the single steps later.

First set the desired pattern that you want to have as first and adjust the tempo and kit like you do with the manual programming.

Because the first Song Step is stored immediately on starting, you should have taken these settings before you go to start.

Now press **(Write)** button.

In Song Mode this LED always flashes to indicate that you are in Song Mode.

Only now you press the **(Start)** button.

Automatically the current settings are stored in Song Step 0 and the repetitions **<Rp000>** are reset to 0 internally.

If you now watch the value of repetitions **RpXXX**, you will find that it counts up (instead of down) after every played pattern. After the first play there is a 001 in that value, after the second a 002 and so forth.

```
Init Kit 092Kick Song001
Pa003 Te123 Rp001 Stp000
```

Let the pattern repeat as often as you want. Then choose another pattern by pressing a step button. If it is stored in another bank, first choose the bank and then the step number.

You can also move the cursor to **Pa0XX** and select the pattern by turning the **(Data)** encoder.

After the current pattern has played back, the display jumps automatically to the next Song Step:

```
Init Kit 092Kick Song001
Pa002 Te123 Rp000 Stp001
```

Now you can let it count up as many bars as you wish and then decide to record another pattern.

Before the last pattern has completely played back the desired number of runs you have to select the new pattern.

This way you can easily create playlists of patterns simply by switching to another pattern after a certain number of played patterns. Automatically a new Song Step is created in the list.

Moreover, **every** input of kit selection, pattern selection and tempo change creates a new Song Step while in Realtime Song Write Mode. So you can use this function to easily create complex songs.

When you are finished with realtime song recording, press the **(Stop)** button and stop the sequencer. The current Song Step is internally set to 0 repetitions and hereby determined as the end of the song.

Only now leave the Song Write Mode by pressing **(Write)** button. The song gets stored, and if you move the cursor to <**Stp**XXX> you can scroll every Song Step by the **(Data)** encoder from 0 to the <FIN> symbol.

You can manually edit the list at any time as described in the past section.

Defining Loops

Instead of having a song with start and end you can also define a song with a start and an infinite loop with free loop points at your choice.

Edit the song in stopped mode as described in Song Mode Manual Editing.

Choose the Song Step where the loop should start, which is mostly the song end.

Move the cursor to Repeats **RpXXX** and lower the value to 0 (<StpFIN> appears right of it) and then turn it once again left until <LOP> appears. The display **Stp** shows again the current Song Step.

```
Init Kit 092Kick Song001  
Pa002 Te123 RpLOP Stp019
```

Now press the **(Write)** button to enter the Song Write Mode. Now you move the cursor right to the step selection and adjust the desired loop point to which the loop should jump to after reaching the endpoint. Because this has to be less or equal to the endpoint (right limit of time axis), you can only adjust values smaller than the current Song Step.

```
Init Kit 092Kick Song001  
Pa002 Te123 RpLOP Stp019
```

Don't forget to leave Write Mode again after editing.

If you now play back this song, it is not finished automatically, but endlessly jumps back to the programmed loop start after reaching the loop point. This is a very useful function for live performances.

2nd Functions



Each of the 16 **(Step)** buttons corresponds to a second function. When you press the **(Shift/Cancel)** button, all 16 red LEDs flash. By pressing the desired **(Step)** button you can enter the desired menu. The orange indicated printing below the **(Step)** buttons informs you about the assigned function.

To cancel the shift function press **(Shift/Cancel)** again, and the display reads "Command aborted". After about 2 seconds, the LEDs stop to flash and the menu returns to the leftmost cursor position.

Store Kit (1)

With this function you store the current drum kit to a memory location. In Performance Mode all instrument parameters are managed in a shared edit buffer. That means, if you have edited all the instruments to your satisfaction, all these sound parameters share the same volatile buffer. To keep this edit buffer, you have to store it to memory by the Store Kit function.

Press **(Shift/Cancel)** and then **(Step 1)**. Now the display shows:

```
Init Kit 000Kick Perf001
Store drum kit? Shif120
```

Choose the desired target kit (if not the old) by scrolling the **(Data/Tempo)** encoder and confirm the task with **(Enter)**. By this technique, you can easily copy kits to other memory locations without changing the old drum kit.

```
Init Kit 002Kick Perf001
Drum kit stored Ed B120
```

Clear Pattern (2)

With this function you can clear the pattern edit buffer. The whole pattern is managed in a temporary edit buffer as well. To clear it, first choose it.

Press **(Shift/Cancel)** and then **(Step 2)**. Now the display shows:

```
Init Kit 000Kick Perf001
Clear pattern? Ed B120
```

Just confirm with the **(Enter)** button, and the pattern in edit buffer gets erased. As long you don't store it, the old pattern in memory remains unchanged.

Store Pattern (3)

This function is used for storing the pattern edit buffer to memory locations.

Press **(Shift/Cancel)** and then **(Step 3)**. Now the display shows:

```
Init Kit 000Kick Perf001
Store pattern? Ed B120
```

With the **(UP)** and **(DOWN)** buttons you have now the chance to choose different memory locations. If you are ready with your choice, hit **(Enter)** and the pattern gets stored.

```
Init Kit 000Kick Perf001
Pattern stored Ed B120
```

Tip: this function may be also used to copy patterns. If you want eg. copy pattern 3 to pattern 4, just choose pattern 3, then the Store Pattern function and then select pattern 4 with the (UP) button and confirm with (Enter), done. Now patterns 3 and 4 are identical. (If pattern 4 wasn't empty before, it is overwritten now, of course...)

A/B Playmode (4)

With this function you decide how both alternative patterns A and B are played back. You can choose between <FIX> and <ALT>. In <FIX> position you can choose between pattern A and B by pressing **(A/B)**. The firmly lighting LEDs show which pattern is selected.

```
Init Kit 000Kick Perf001  
A/B Play M.= ALT Shif004
```

If <ALT> was chosen, both patterns are played back alternately forming them into an actual 32 step pattern. To be able to edit them while the sequencer is running, you can choose with the **(A/B)** button which part pattern is to be edited by **(Step)** buttons. The editable A/B LED flashes, while the played back A/B LED lights up firmly.

Last Step (5)

With function Last Step you can change the number of steps of a pattern. You can choose a number from 1 to 16 steps. Default value is 16.

```
Init Kit 000Kick Perf001  
Last Step = 016_ Shif005
```

The Last Step information is only stored in the edit buffer and has to be stored to memory for further recall.

lagged (+6 would be the earliest step of the neighboured beat).

Realtime Write (7)

This function is useful for live recording of instruments. You have to be either in Perform Write or in Pattern Write mode. Activate the Realtime Write function with **(Shift) + (Step 7)**. The display shows:

```
Init Kit 000Kick Perf001  
Real Time Write Shif007
```

Start the sequencer and record your drum pattern by playing the instrument keys. During the realtime recording a metronome is playing. It is an 808 Rimshot and the 1 is played louder than the other beats.

To stop recording press **(Shift/Cancel)**.

» **Note:** *As with manual step editing, only the edit buffer is recorded. You have to store it or the pattern is discarded on the next pattern selection.*

Filter Routing (8)

With **(Shift) + (Step 8)** you are entering the filter routing menu. The display shows the following:

```
Filter Routing  Perf001
x^x^~~~~~x Stereo Shif008
```

With the **(Data)** encoder you can select the following cross filter modes:

- <Stereo>** Stereo
Both filters run independently.
- <Parall>** Parallel
Both filter outputs are mixed together...good for multipole filters.
- <Serial>** Serial
The signal first passes the left and then goes into the right filter.
- <Feedback>** Feedback
The outputs of each filter are cross feedbacked into the input of the other filter, but the outputs are stereo (not mixed). Hear the harsh resonant and distorting filter peaks, especially when modes (i.e. LP / HP) are different on both filters.
- <FedbPar>** Feedback parallel
The outputs of each filter are cross feedbacked into the input of the other filter, and the outputs are mixed. This generates the most distorted and crying feedbacks or extreme filter slopes.

By the **(Instrument)** keys you can decide which instruments are routed into the filter.

The lower display row shows the routing.

These symbols are used:

<X> Instrument is not plugged into the filter

<^> Instrument is plugged into the filter

You quit the Filter Routing menu by pressing **(Enter)**.

» **Note:** The Filter Routing information is stored along with a Drum Kit in Perform Mode (See also The Filter p. 47).

Stereo Panning (9)

The keys **(Shift/Cancel)** + **(Step 9)** activate the Stereo Panning function which controls the stereo pan position of the instruments in the main mix except for the bass drum.

The display shows the following:

c<c>c<c>cStereo	Perf001
█x█x█x█x█ Pan	Shif009

Following symbols are used:

<<←> left pan

<→> right pan

<c> center position

< > shows the intensity of L/R panning

The **(Encoders)** 1..9 assigned to the instruments control the pan position. When all editings are done, leave the function with **(Enter)**.

Split Mode (10)

By pressing **(Shift/Cancel)** + **(Step 10)** you enter the Split Mode function. Two different modes are at your choice:

```
Init Kit 000Kick Perf001
Split Mode = SM1 Shif010
```

<SM1> The bass drum is only played on standard note C1 and is played with the internal pitch.

<SM2> The bass drum pitch and other instruments are played over the whole keyboard, and the pitch is taken from the key note.

For the assignment see the Midi Implementation in the appendix. Confirm your selection with **(Enter)** or quit with **(Shift/Cancel)**.

» **Note:** To play the bass drum in musical semitones, the **Scale** parameter must be set to **<SEM>!** (See p.)

Clock Select (11)

With **(Shift/Cancel)** + **(Step 11)** you are entering the Clock Select menu. You can decide if the XBASE 999 uses its internal clock or if it is synchronized to an external midi clock master.

```
Init Kit 000Kick Perf001
Clock Source INT Shif011
```

<INT> Internal clock. The XBASE 999 generates its own clock and puts out midi clock on the midi out port (if enabled in TxClk). Connected midi slave devices can synchronize to the XBASE 999.

<MID> External midi clock. The XBASE999 synchronizes to an external midi clock signal.

Confirm your selection with **(ENTER)** or quit with **(Shift/Cancel)**.

» **Note:** *If clock select is set to <MID>, the sequencer of the XBASE 999 will not react to the start button, but only start if it receives a proper midi clock signal!*

Metronome (12)

Here you can turn on or off the metronome for Real Time Write mode. With the **(Data/Tempo)** encoder you can select <ON> or <OFF>.

```
Init Kit 000Kick Perf001
Metronome = OFF Shif012
```

Here you can turn on or off the metronome for Real Time Write mode. With the **(Data/Tempo)** encoder you can select <ON> or <OFF>. Confirm your selection with **(ENTER)** or quit with **(Shift/Cancel)**.

Sample Select (13)

With **(Shift/Cancel)** + **(Step 13)** you are entering the Sample Select menu. This function changes the selected sample on the sample based instruments. By the **(Instrument)** keys you select the instrument and by the **(Data/Tempo)** encoder the selection takes place. When all editings have been made, leave the function with **(ENTER)**.

» **Note:** *this is only a hotkey to enter the edit menu. You could also reach this fuinction with **(Write)**-> **(Instrument)** and encoder 11 (Sample).*

Reverse (14)

With **(Shift/Cancel) + (Step 14)** you are entering the Reverse menu. You have the possibility to play back samples of the sample based instruments reversely. Please select the instrument by the **(Instrument)** keys and change the the reverse function to <ON> or <OFF> by means of the **(Data/Tempo)** Encoder. When all editings have been made, leave the function with **(ENTER)**.

» **Note:** *this is only a hotkey to enter the edit menu. You could also reach this function with **(Write)**-> **(Instrument)** and then move the cursor to Reverse<OFF>.*

LFO Page (15)

With **(Shift/Cancel) + (Step 15)** you are entering the LFO menu . Alternatively you can reach this menu in Edit Mode by using the **(Left)** and **(Right)** cursor. (See Edit Mode p.24)

Midi Tracks (16)

By pressing **(Shift/Cancel) + (Step 16)** you are entering the Midi Tracks. With these you can create up to 4 different midi tracks in a 16th grid in order to play external midi devices like synthesizers or samplers. You can either use them on 4 different channels to play up to 4 different monophonic sound devices or use them on one channel to play polyphonic chords on one external synthesizer.

After selecting an empty track the display shows the following:

```
Sta Ch01
xxxxxxxxxxxxxxxxC 5 Trk1
```

On first selection of Midi Tracks, you are automatically in Write Mode on track 1.

Press the desired steps on which a midi note is to be played. The step LED and the corresponding LED at the edit encoders 1..16 lights up.

Also in the LCD display the steps are displayed:

```
Sta Ch01
 _xxx_xxx_xxx_xxxC 5 Trk1
```

By the individual **(encoders)** 1..16 that correspond to the step buttons 1..16 you can control the note pitch of the selected step. Right next to the 16th step row the display shows the current note pitch and octave in alphanumerical fashion, and the bar shows the note (the height resembles the 12 halftones) within an octave. The possible range goes from C1 to D#6, this is a bit more than 5 octaves.

```
Sta Ch01
 _xxx█xxx█xxx_xxxF#3 Trk1
```

If you move the cursor across the bars you can display the programmed note of a step at any time. The bar display is only a

rough overview of the 12 halftones that doesn't show the octave.

If you move the cursor to the extend of the 16 bars, you can edit the parameters stakkato/legato and the midi channel.



In play mode stakkato (Sta) all notes are played independently of the pitch as single 16th notes.

In play mode legato (Leg) neighboured notes that have the **same** pitch (also the same octave) are bound and played as a long note. So you can also create different note lengths as 8th (2 steps), pointed 8th (3 steps), quarters (4 steps) a.s.o. in your midi track.

All editings on the midi tracks can be made whilst the sequencer is running. So you can instantly hear how the melody or the effect track on your hooked up midi device sounds.

If you want to make another mono track, press the snare drum button. Now you can create another independent midi track as described above.

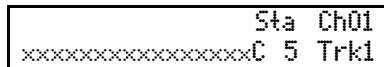

If track 2 is on the same midi channel as track 1, both tracks are played polyphonical on the hooked up synthesizer if that is able to do this.

Thus, with maximum 4 tracks you can program maximum 4 times polyphonic chords.

But you can also control up to 4 different mono synthesizers on separate midi channels.

The 4 tracks are to be chosen by the buttons Bass Drum, Snare Drum, Low Tom and High Tom.

For creative usage of controlled midi synthesizers during live performance, you can mute the tracks by click on the encoders 10-13. On muted midi tracks the corresponding LED blinks red. The mute function is independently of other menu levels available at any time.

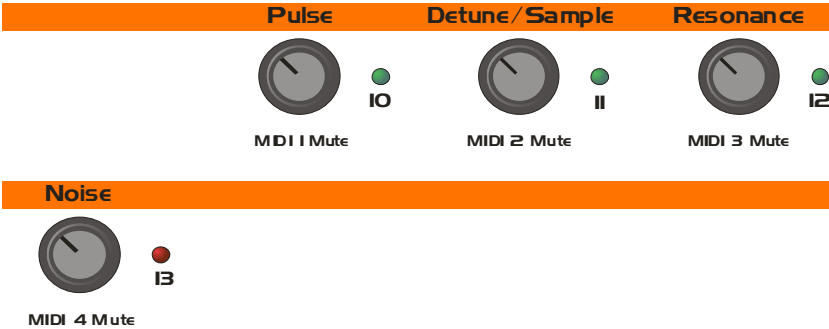

To leave the Midi Track edit page, press the Enter button.

» **Note:** Don't forget to save the pattern, because all editings are only made in the edit buffer and get lost after a pattern change.

Appendix

MIDI Implementation XBASE 999

1. Sound Parameter (Continuous Controllers)

BASS DRUM	CONTROLLER NO.	VALUE RANGE	INTERNAL RANGE
Tune	100	0-127	0-127
Pitch	101	0-127	0-127
Decay	102	0-127	0-127
Harmonics	103	0-127	0-127
Pulse	104	0-127	0-127
Noise	105	0-127	0-127
Attack	106	0-127	0-127
EQ	107	0-7	0-7
Gate time	99	0-127	0-15
Compression	98	0-127	0-127
BD Level	117	0-127	0-127

SNARE DRUM	CONTROLLER NO.	VALUE RANGE	INTERNAL RANGE
Tune	108	0-127	0-127
Snappy	109	0-127	0-127
Decay	110	0-127	0-127
Detune	111	0-127	0-127
Noise Tune	112	0-127	0-127
SD Level	118	0-127	0-127

LOW TOM	CONTROLLER NO.	VALUE RANGE	INTERNAL RANGE
Tune	12	0-127	0-127
Decay	13	0-127	0-127
LT Level	14	0-127	0-127

HIGH TOM	CONTROLLER NO.	VALUE RANGE	INTERNAL RANGE
Tune	15	0-127	0-127
Decay	16	0-127	0-127
HT Level	17	0-127	0-127

HI HAT	CONTROLLER NO.	VALUE RANGE	INTERNAL RANGE
Tune	18	0-127	0-127
CH Attack	19	0-127	0-127
CH Peakttime	20	0-127	0-127
CH Decay	21	0-127	0-127
OH Attack	22	0-127	0-127
OH Peakttime	23	0-127	0-127
OH Decay	24	0-127	0-127
HH Level	25	0-127	0-127
HHF Cutoff HP	59	0-127	0-127
HHF Cutoff LP	60	0-127	0-127
HHF Resonance	61	0-127	0-127
HH Source	62	32-34	Nor, Fil, Noi
Reverse	62	20-21	Off, On
Sample select	63	0-30	909-S31

CLAP	CONTROLLER NO.	VALUE RANGE	INTERNAL RANGE
Tune	26	0-127	0-127
Attack	27	0-127	0-127
Peakttime	28	0-127	0-127
Decay	29	0-127	0-127
CLP Level	30	0-127	0-127
Reverse	62	22-23	Off, On
Sample select	63	32-62	909-S31

RIM SHOT	CONTROLLER NO.	VALUE RANGE	INTERNAL RANGE
Tune	44	0-127	0-127
Attack	45	0-127	0-127
Peaktime	46	0-127	0-127
Decay	47	0-127	0-127
RIM Level	48	0-127	0-127
Reverse	62	24-25	Off, On
Sample select	63	64-94	909-S31

CRASH	CONTROLLER NO.	VALUE RANGE	INTERNAL RANGE
Tune	49	0-127	0-127
Attack	50	0-127	0-127
Peaktime	51	0-127	0-127
Decay	52	0-127	0-127
CRH Level	53	0-127	0-127
Reverse	62	26-27	Off, On
Sample select	63	96-126	909-S31

RIDE	CONTROLLER NO.	VALUE RANGE	INTERNAL RANGE
Tune	54	0-127	0-127
Attack	55	0-127	0-127
Peaktime	56	0-127	0-127
Decay	57	0-127	0-127
RID Level	58	0-127	0-127
Reverse	62	28-29	Off, On
Sample select	70	0-30	909-S31

FILTER LEFT	Controller No.	Value range	Internal Range
Cutoff	85	0-127	0-127
Q	86	0-127	0-127
Resonance	87	0-127	0-127
Filter Mode	93	0-3	LP, HP, BP, NT

FILTER RIGHT	CONTROLLER NO.	VALUE RANGE	INTERNAL RANGE
Cutoff	88	0-127	0-127
Q	89	0-127	0-127
Resonance	90	0-127	0-127
Filter Mode	93	4-7	LP, HP, BP, NT

FILTER GLOBAL	CONTROLLER NO.	VALUE RANGE	INTERNAL RANGE
Gain	91	0-127	0-127
VCA Out	92	0-127	0-127
Routing	93	8-12	Ste, Par, Ser, Fb, FbPar
Bass->Filter	93	13,14	Off, On
Snare->Filter	93	15,16	Off, On
LoTom->Filter	93	17,18	Off, On
HiTom->Filter	93	19,20	Off, On
HH->Filter	93	21,22	Off, On
Clap->Filter	93	23,24	Off, On
Rim->Filter	93	25,26	Off, On
Crash->Filter	93	27,28	Off, On
Ride->Filter	93	29,30	Off, On

MUTE GLOBAL	CONTROLLER NO.	VALUE RANGE	INTERNAL RANGE
Bass	93	31,32	Off, On
Snare	93	33,34	Off, On
LoTom	93	35,36	Off, On
HiTom	93	37,38	Off, On
HH	93	39,40	Off, On
Clap	93	41,42	Off, On
Rim	93	43,44	Off, On
Crash	93	45,46	Off, On
Ride	93	47,48	Off, On

STEREO PAN	CONTROLLER NO.	VALUE RANGE	INTERNAL RANGE
Snare	33	0-127	0-127 64=Center
LoTom	34	0-127	0-127 64=Center
HiTom	35	0-127	0-127 64=Center
HH	36	0-127	0-127 64=Center
Clap	37	0-127	0-127 64=Center
Rim	38	0-127	0-127 64=Center
Crash	39	0-127	0-127 64=Center
Ride	40	0-127	0-127 64=Center

LFO 1	CONTROLLER NO.	VALUE RANGE	INTERNAL RANGE
Wave Free	75	0-3	Sup, Sdo, Tri, Rct
Wave Sync	75	4-7	Sup, Sdo, Tri, Rct
Destination	76	0-11	BDt, SDt, LTt, HTt, HHT, HHF, CPt, RMT, CRT, RDt, FCR, FCL
Intensity	77	0-127	0-127
Speed	78	0-127	0-127

LFO 2	CONTROLLER NO.	VALUE RANGE	INTERNAL RANGE
Wave Free	79	0-3	Sup, Sdo, Tri, Rct
Wave Sync	79	4-7	Sup, Sdo, Tri, Rct
Destination	80	0-5	BDt, SDt, LTt, HTt, FCR, FCL
Intensity	81	0-127	0-127
Speed	82	0-127	0-127

Store Instruments via Midi Controller

By sending value 64 of Midi Controller no. 62, instruments can be stored.

 Storing of instruments via
 Controller 62 • Value: 64

Bankselect Command

To select a bank via midi bankselect command, you have to send a program change command after the bankselect command. Only then the bank will be changed.

2. Note Commands

XBASE 999 Instrument	Midi Instr. Name	Note Number	Note
Kick Drum	Bass/Kick Drum	36	C1
Snare Drum	Electric Snare	40	E1
Lo Tom	Low Floor Tom	41	F1
Hi Tom	High Floor Tom	43	G1
Cl. Hi Hat	Closed Hi Hat	42	F#1
Cl. Hi Hat lang	Pedal Hi Hat	44	G#1
Open Hi Hat	Open Hi Hat	46	A#1
Clap	Clap	39	D#1
Rim Shot	Rim Shot	37	C#2
Crash	Crash	49+50	D2+C#2
Ride	Ride	52+53	E2+F2

3. Sysex Commands

The unit channel equals to the midi channel.

Preset bulk dump

\$F0(Sysex begin), \$31(JoMoX-manufact. code), \$7F(Command Sys Ex dump), \$59(Product code), \$0X(Unit Channel),XX(Data0),XX(Data1),..., \$F7(End of SysEx)

OS bulk dump

\$F0(Sysex begin), \$31(JoMoX-manufact. code), \$7F(Command Sys Ex dump), \$59(Product code), \$1X(Unit Channel),XX(Data0),XX(Data1),..., \$F7(End of SysEx)

Flash bank bulk dump

\$F0(SysEx begin), \$31(JoMoX-manufact. code), B01xx xxxx(Flash bank 7..61), \$59(Product code), \$2X(Unit Channel),XX(Data0),XX(Data1),..., \$F7(End of SysEx)

Flash bank erase command

(must come before a flash bulk dump)

\$F0(SysEx begin), \$31(JoMoX-manufact. code), \$0D, \$79, B00xx xxxx(Flash bank 7..61), \$F7(End of SysEx)

Dump request command

\$F0(SysEx begin), \$31(JoMoX-manufact. code), \$0E, \$59, \$F7(End of SysEx)

Specifications

- 9 instruments: Bass Drum, Snare Drum, Hi Tom, Low Tom, Hi Hat, Clap, Rim Shot, Crash, Ride.
- Analog kick, toms, snare.
- Analog multimode stereo filter with Cutoff, Q, Res and Gain per channel.
- LP/HP/BP/Not Mode per channel, 5 routings, VCA Out in mix out.
- 5 sample based instruments with analog VCA envelope.
- 31 samples per instrument (HH has 2 Samples) per instrument - 155 total.
- HH Filter: In the hihat section an extra analog filter may be inserted. Signal source can be wether sample or noise. HP/LP cutoff are adjustable, resonant capable.
- LFOs: 2 of which are assignable to different parameters
- Own samples can be uploaded by the Jomox Editor
- Midi: Midi In, Midi Out, Midi Thru
- Inputs: Filter Stereo In
- Outputs: 10 individual outs, stereo mix, headphone
- Output Level: about +4dBu at max. volume on all outputs
- 19 encoders
- Phones Volume
- LCD Display 2x 24 Characters
- 10.5V 2A ~AC external power supply
- Metal steel enclosure
- Wooden end cheeks
- Weight 5kg

Service, Updates, Tips and Tricks

Are available at JoMoX GmbH

In the Internet www.jomox.com

By Mail :

JoMoX GmbH
Körtestr. 10
D-10967 Berlin
Germany

By Fax +49-(0)30-61702574

Or email mail@jomox.de

We hope that you'd have lots of entertainment, joy and timeless awareness with our products.

Thanks for eventual feedback!

Cheers,
Jürgen Michaelis

Berlin, 2006-2008

Editors: Sebastian Preller, Jürgen Michaelis

2. Editing: Jürgen Michaelis