

Service Manual Korg SDD-3000

This file is a scan from the
original service manual.
Never pay for a copy of this file.
It should be available for free!



DIGITAL DELAY SERVICE MANUAL

SDD-3000

CONTENTS

1. SPECIFICATIONS	1
2. STRUCTURAL DIAGRAM	2
3. BLOCK DIAGRAM	3
4. CIRCUIT DIAGRAM	4
5. REFERENCE DATA	7
6. PC BOARD	9
7. CHECK AND ADJUSTMENT PROCEDURE ...	14
8. PARTS LIST	16

1. SPECIFICATIONS

INPUT (0dBm = 775mV)	Input level -30dBm -10dBm + 4dBm	Impedance 470Kohm 47Kohm 10Kohm	Max (Clip) Level (VR at 5) -13dBm + 7dBm +21dBm
OUTPUT (0dB = 775mV)	Output level -20dBm -10dBm + 4dBm	Max (Clip) Level - 3dBm + 7dBm +21dBm	
FREQUENCY RESPONSE	20 ~ 20KHz ±0.5dB (Direct) 20 ~ 17KHz +0.5dB (Effect) -3dB (Effect)		
DYNAMIC RANGE	110dB (Direct) A-Weighted 94dB (Effect)	"	
S/N RATIO	95dB (Direct) 88dB (Effect)	"	
TOTAL DISTORTION	0.005% Typical at 1KHz (Direct) 0.03% Typical at 1KHz (Effect)		
FILTER	LOW CUT	Turn over freq 125Hz 250Hz 500Hz	Roll Off -3dB/OCT -3dB/OCT -3dB/OCT
	HIGH CUT	8KHz 4KHz 2KHz	-6dB/OCT -6dB/OCT -6dB/OCT
MODULATION	VCO frequency range 0.1Hz ~ 15Hz Waveform (∧, ▮, Random, Envelope) Intensity (0 - 2:1)		
DELAY TIME	0 ~ 1023msec 1msec step (With full bandwidth)		
DIMENSIONS	482(W) x 46(H) x 381(D) mm		
WEIGHT	6 Kg		
POWER SUPPLY	Local voltage		
POWER CONSUMPTION	22 W		

2. STRUCTURAL DIAGRAM

3. BLOCK DIAGRAM

PART NO.	PARTS NAME	REMARKS
1	Main frame	KOC-C28002
2	Front frame	KOC-C28000
3	Cover A	KOC-C28002
4	Cover B	KOC-C28003
5	Front panel	KOC-C28001
6	GND terminal	T-10
7	Power Transformaer	TA800 or TB800
8	Buffer of cover	KOC-F48003
9	PC board (KLM-808)	
10	PC board (KLM-802)	
11	PC board (KLM-800)	
12	PC board (KLM-801)	
13	Shielding sheet D	KOC-F48009
14	Shielding sheet B	KOC-F48005
15	Shielding sheet C	KOC-F48007
16	Rubber feet	KOC-F48000
17	Model number plate	
18	SW maks A	KOC-F48001
19	SW mask B	KOC-F48001
20	SW mask C	KOC-F48002
21	Power SW knob (Black)	
22	Tact SW knob (Black)	KT-8
23	Tact SW knob (Gray)	KOC-E48001
24	Tact SW knob (Yellow)	KOC-E48001
25	Tact SW knob (Red)	KOC-E48001
26	Led filter	KOC-E48000
27	Rotary VR knob	2715603
28	Knob cap (Yellow)	3015116
29	Knob cap (Gray)	3015111
30	Radiation mask	KOC-F48006
31	Shielding sheet E	KOC-F48011
32	Spacer D	KOC-C48007

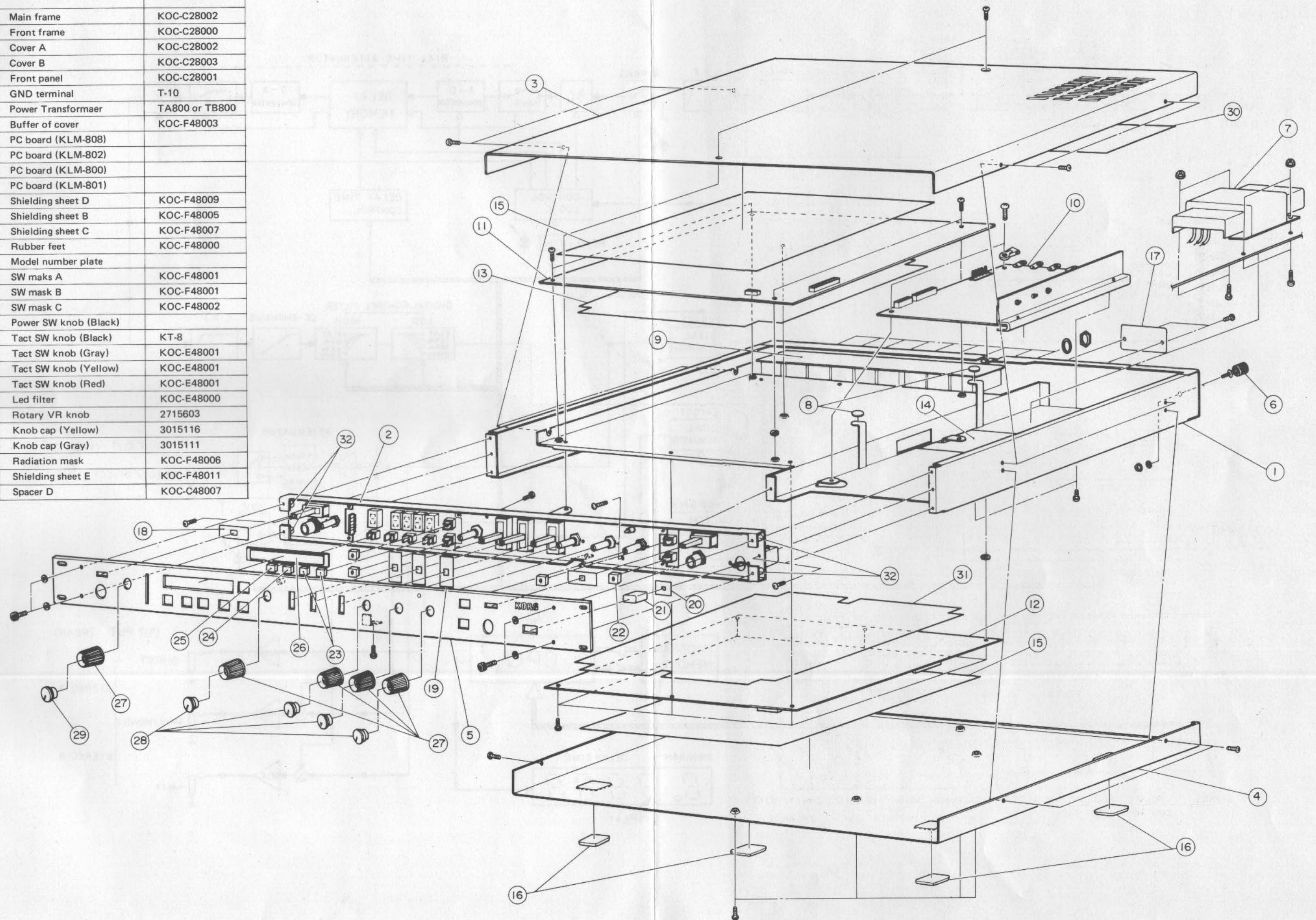

3. BLOCK DIAGRAM

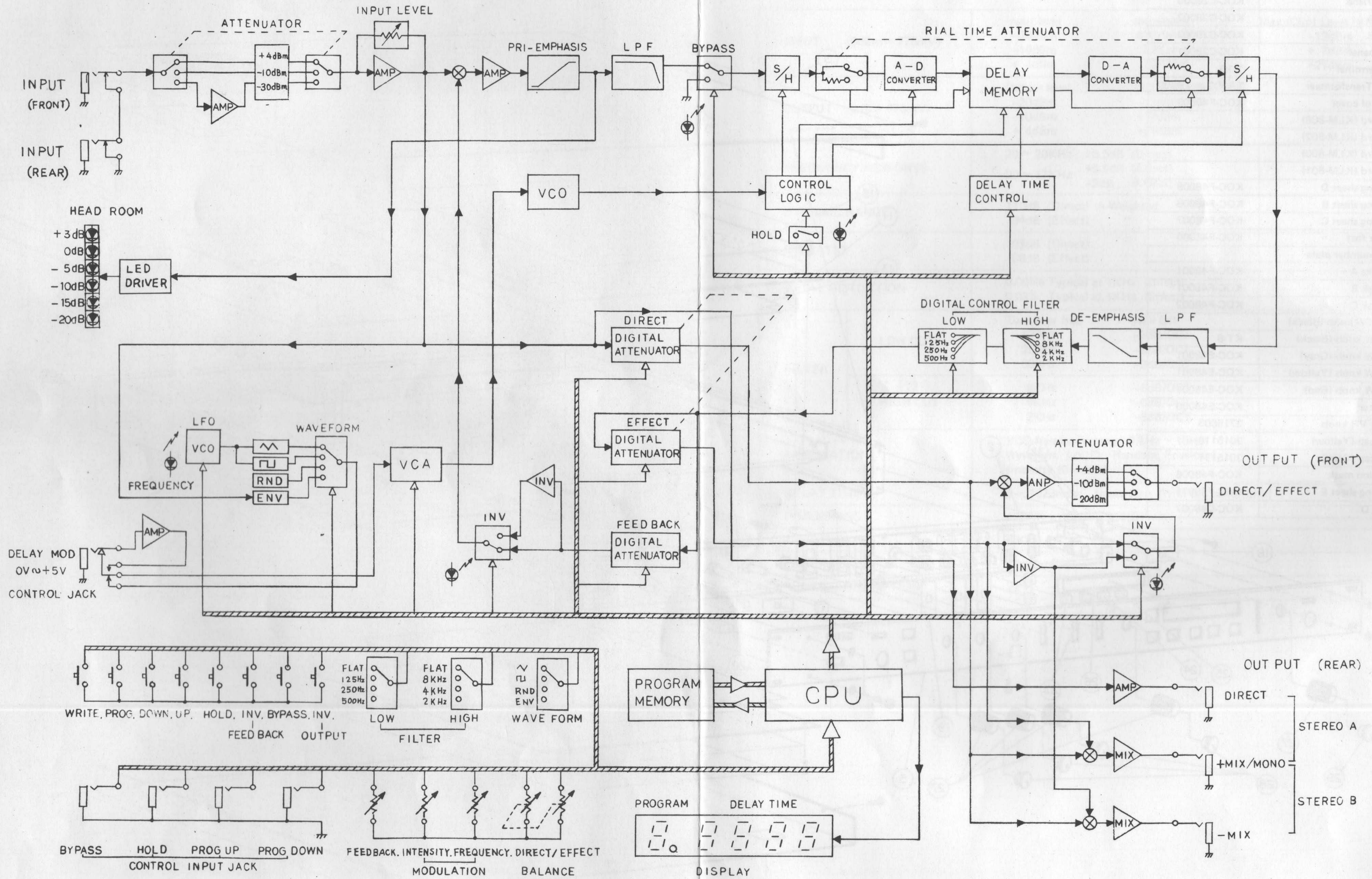

4. CIRCUIT DIAGRAM

KLM-800

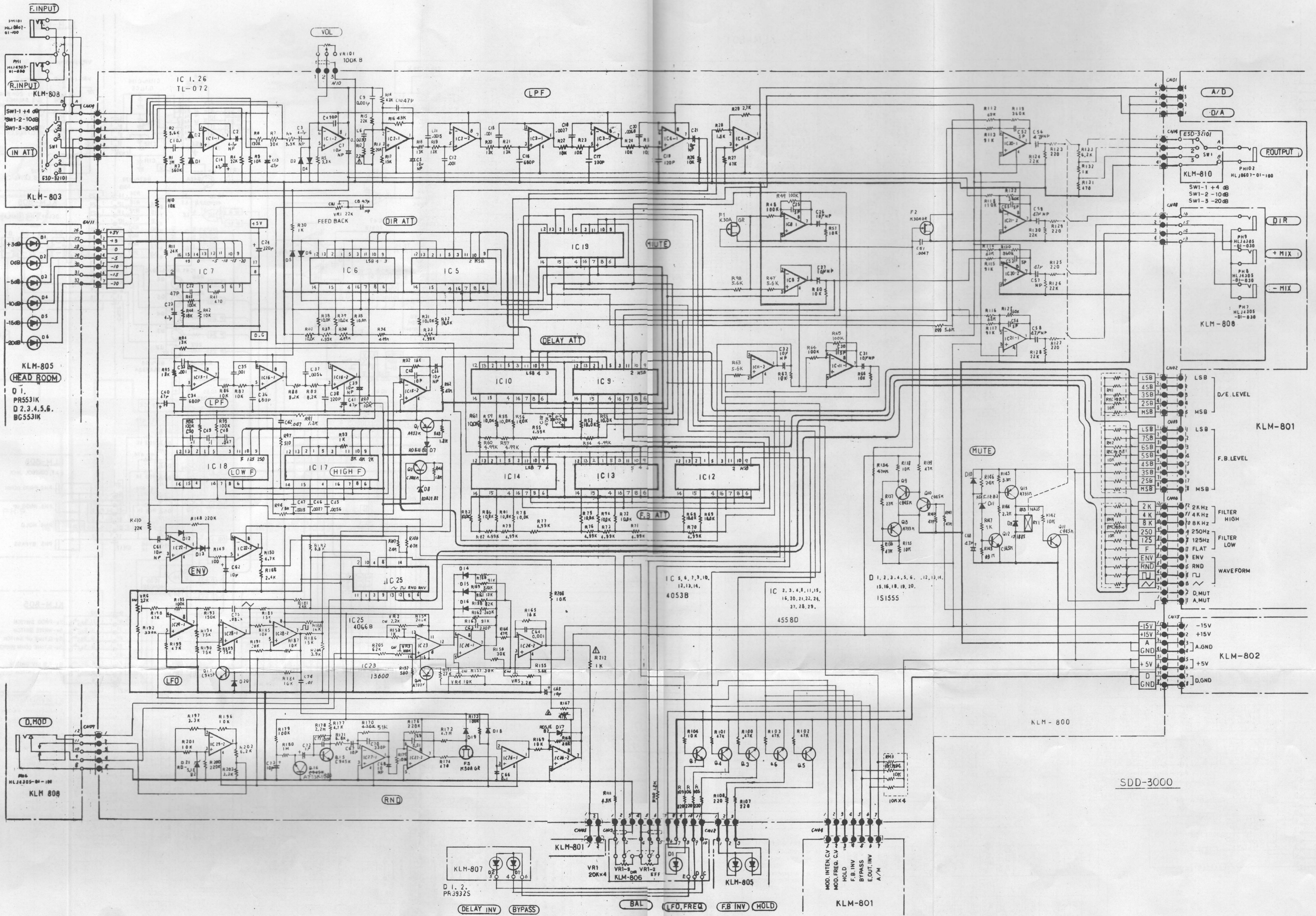

KLM-801

KLM-801

KLM-806

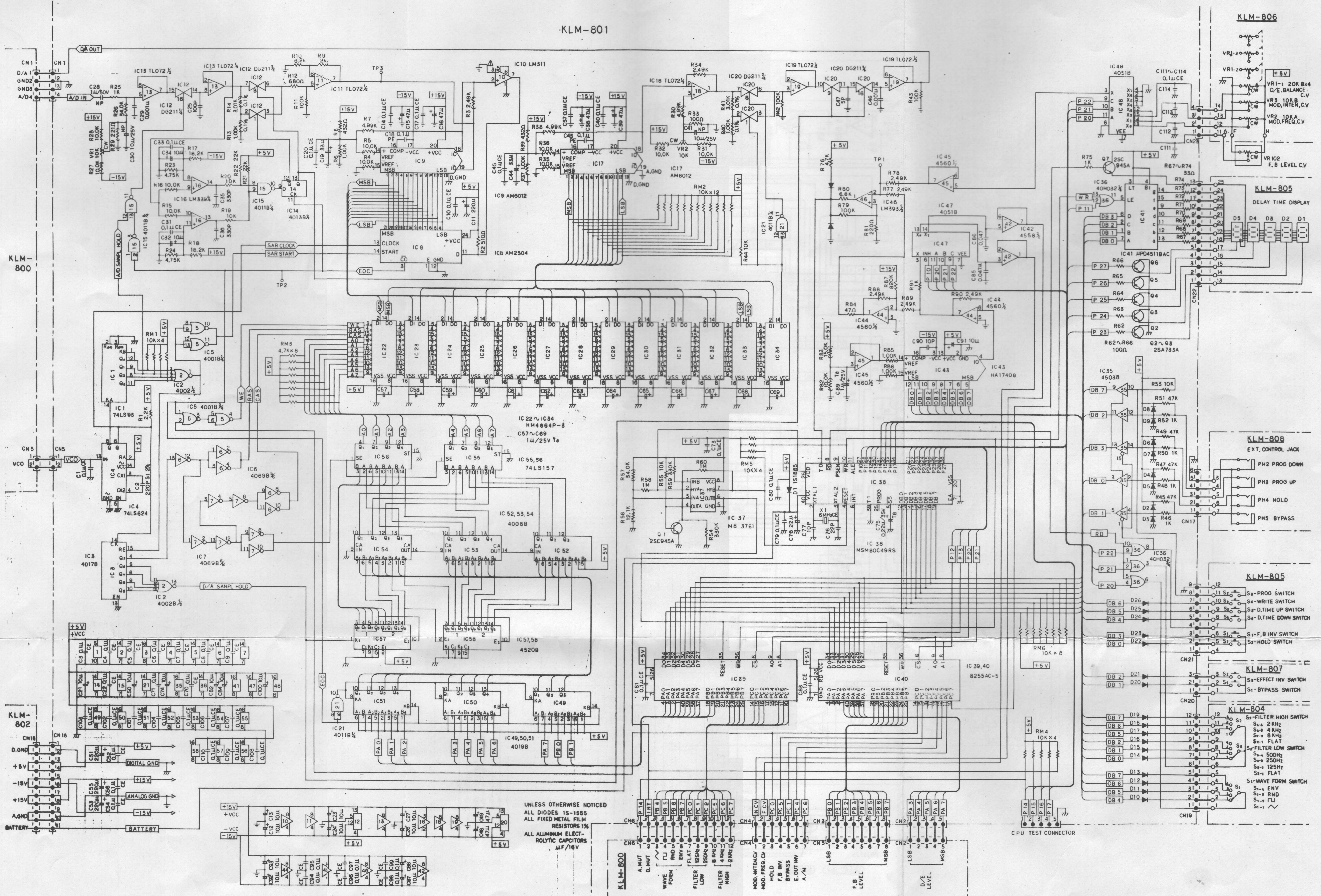

UNLESS OTHERWISE NOTICED
 ALL DIODES 1S-1555
 ALL FIXED METAL FILM
 RESISTORS 1%
 ALL ALUMINUM ELECT.
 POLYESTER CAPACITORS
 100P/10V

KLM-800

KLM-802

KLM-800

KLM-805

KLM-808

KLM-805

KLM-807

KLM-804

KLM-802

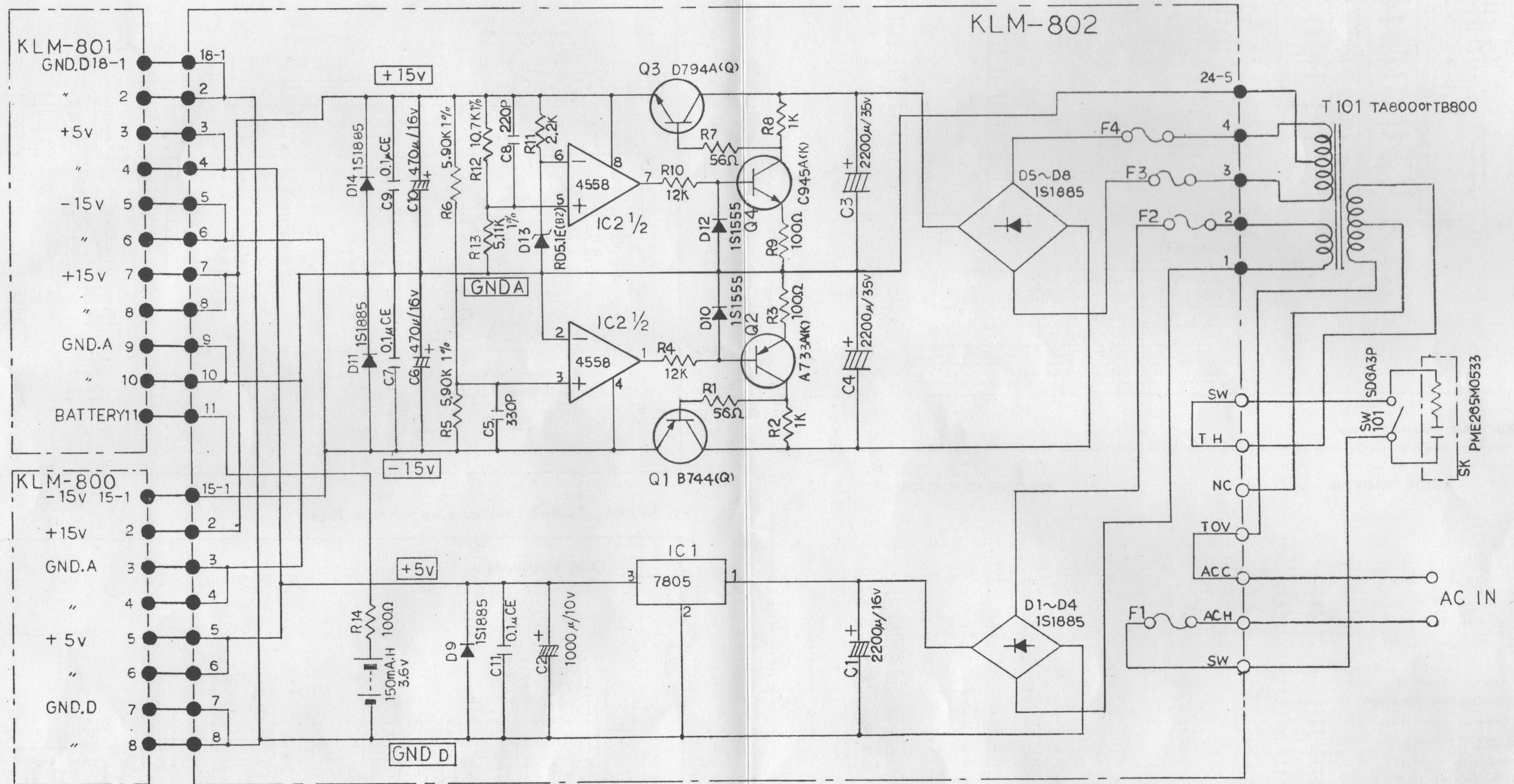

	F1	F2	F3, F4	T101
100V		Δ 3A	Δ 1A	TA-800
117V	250V 0.5A	125V 1.6A	250V 0.5A	
220V	Δ 0.5A		Δ 0.5A	
240V	250V T-315mA	250V T-1.6A	250V T-250mA	TB-800

5. REFERENCE DATA

IC 4864 65536-word x 1 bit Dynamic Random Access Memory

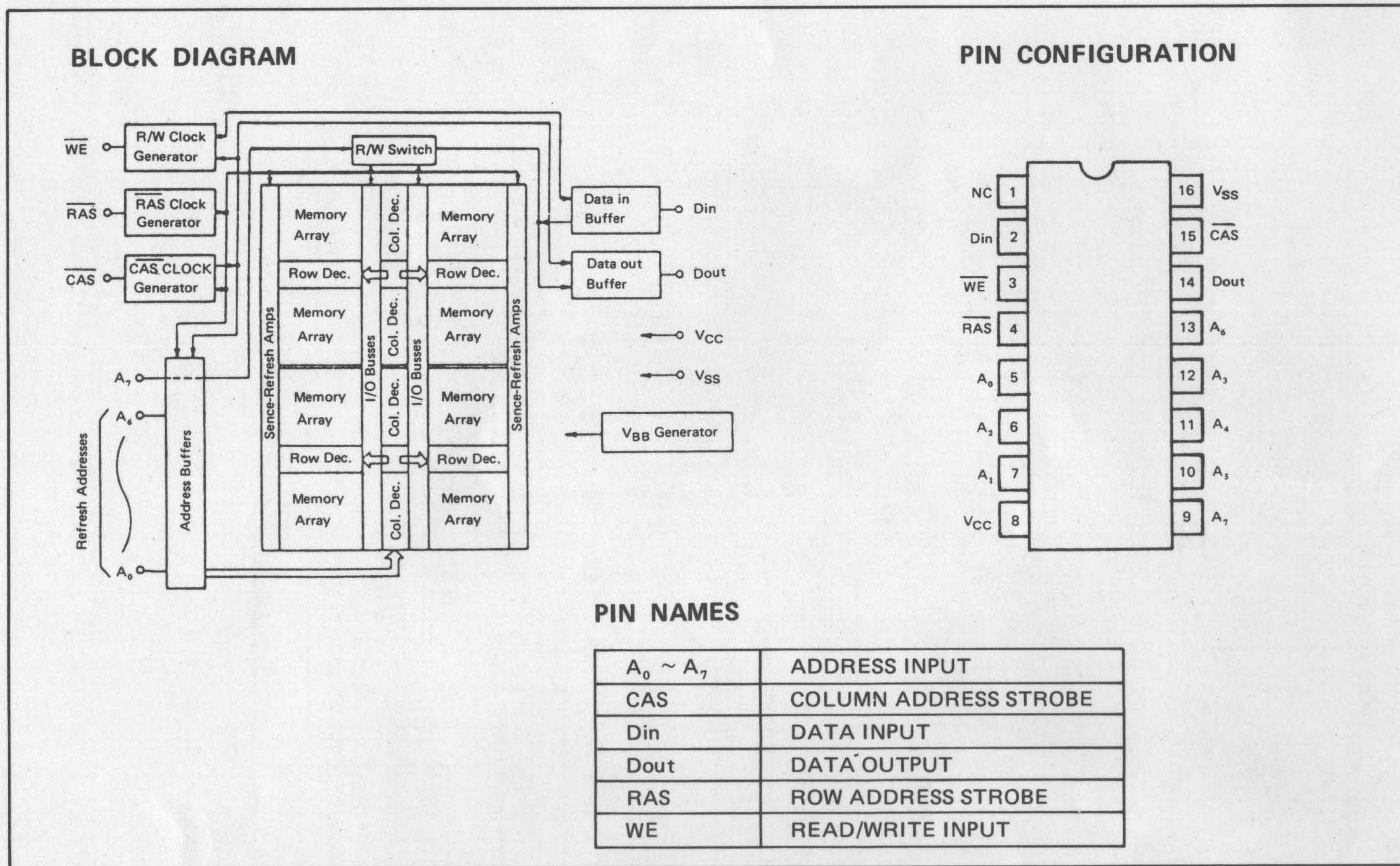

IC 80C49RS 8 bit - Microprocessor

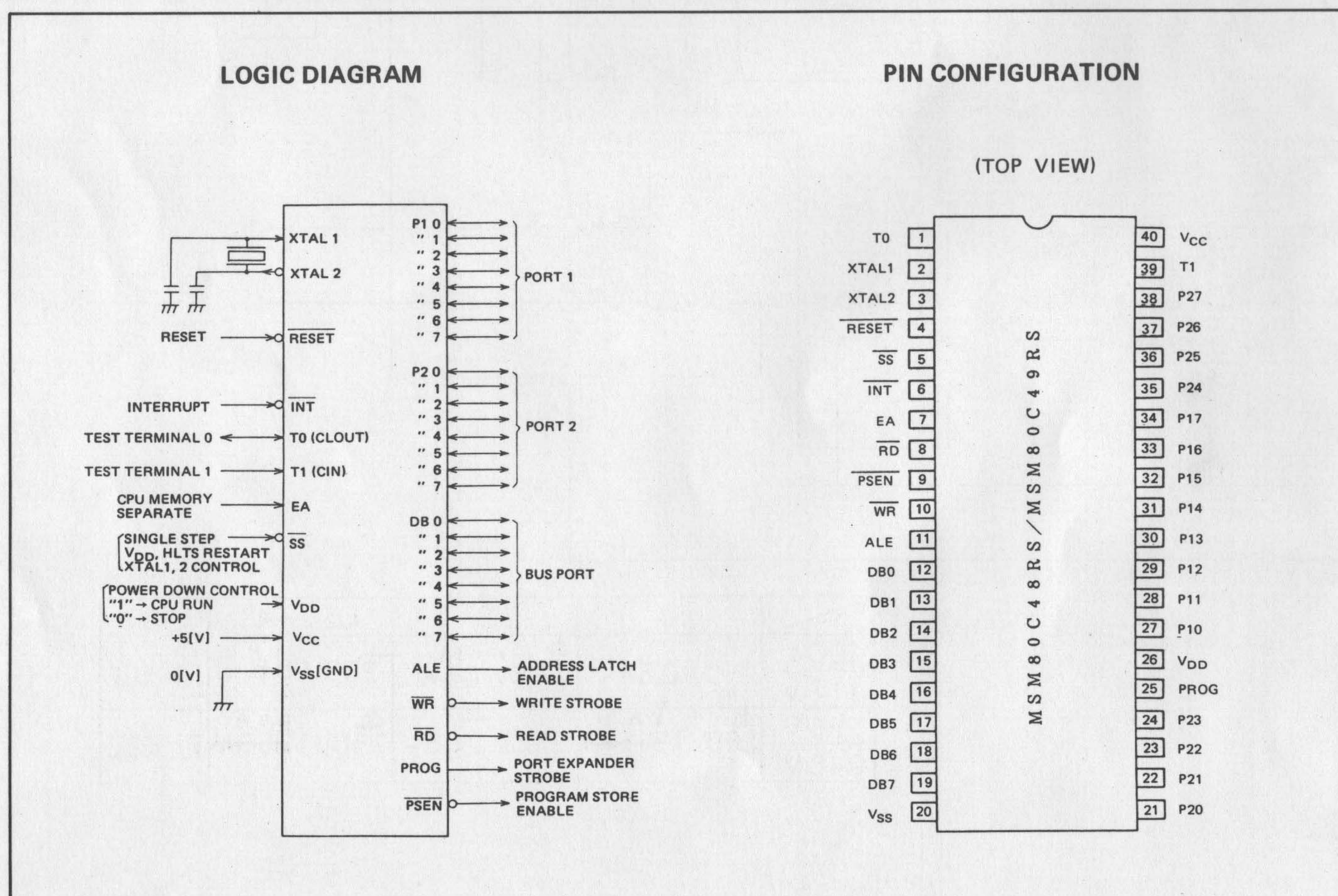

BLOCK DIAGRAM

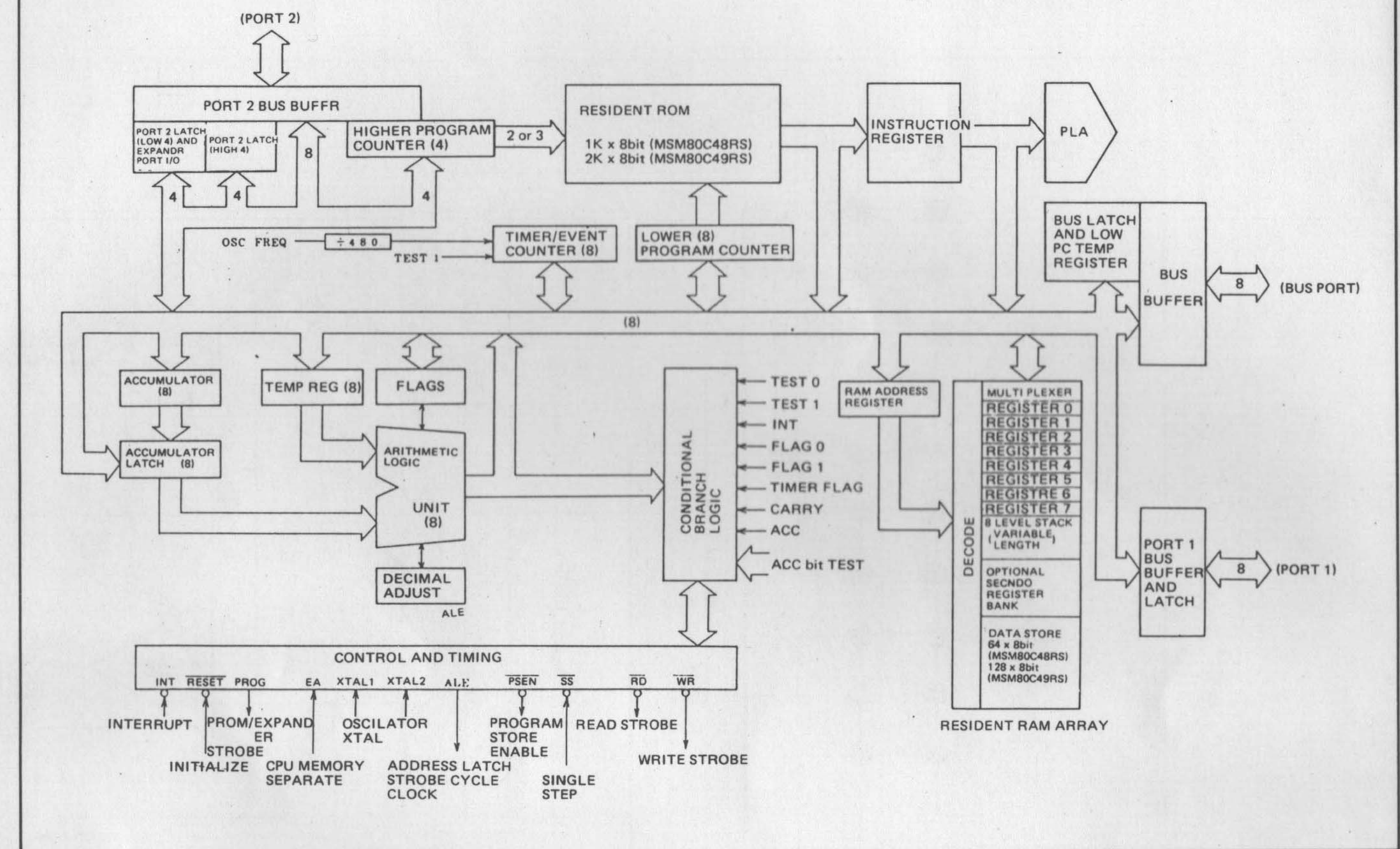

IC AM2504 Twelve-Bit Successive Approximation Registers

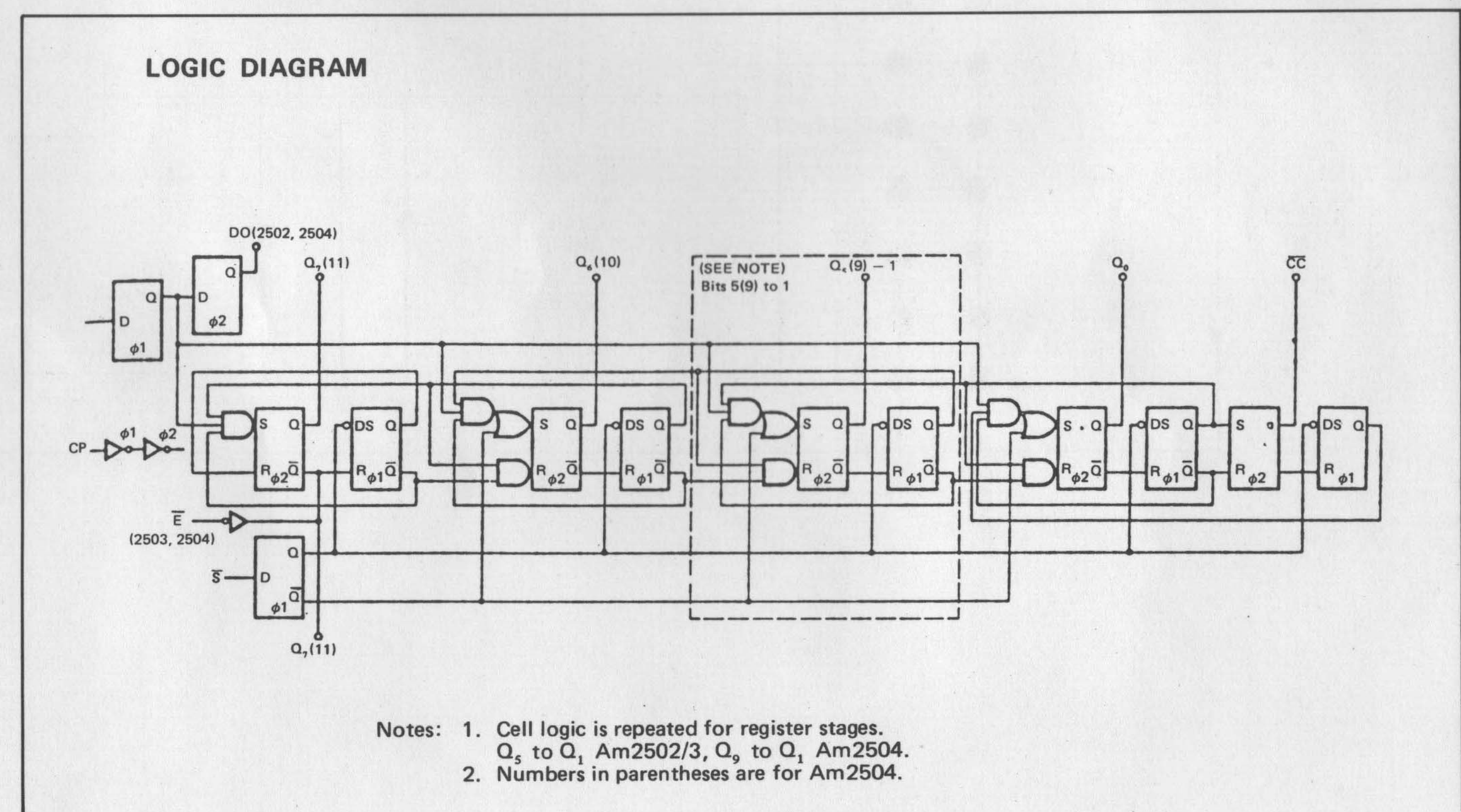

LOGIC SYMBOLS

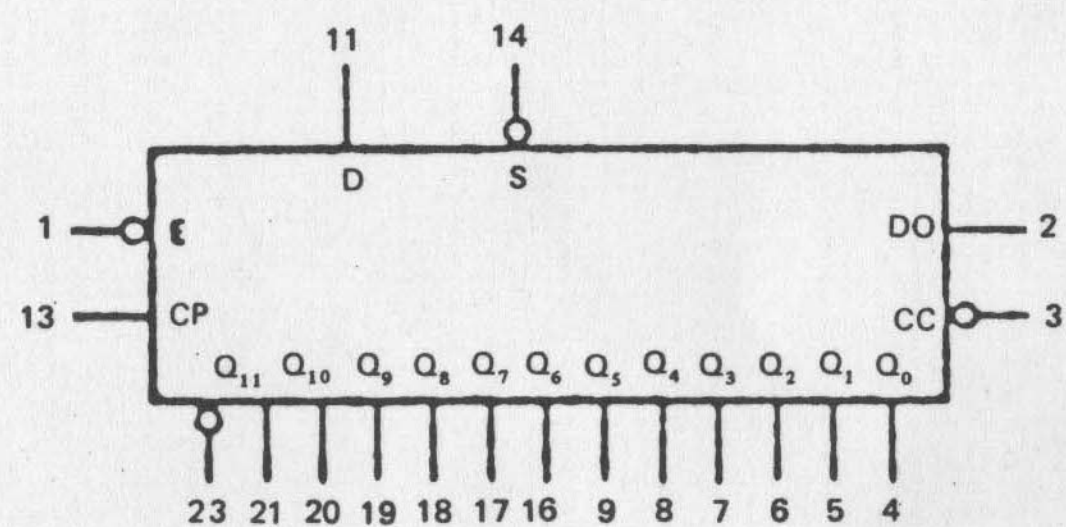

V_{CC} = PIN 24
 GND = PIN 12
 NC = PINS 10, 15, 22

PIN CONFIGURATION

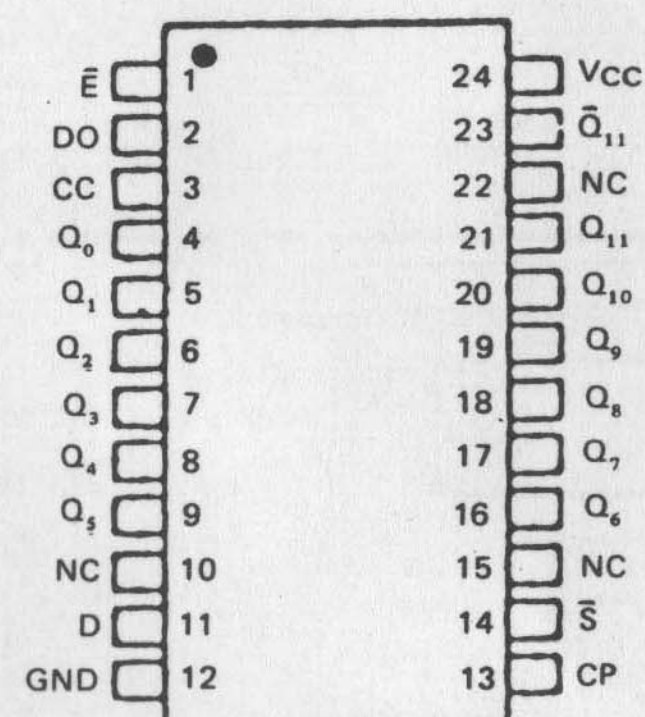

IC AM6012 12 bit High Speed Multiplying D/A Converter

FUNCTIONAL DIAGRAM

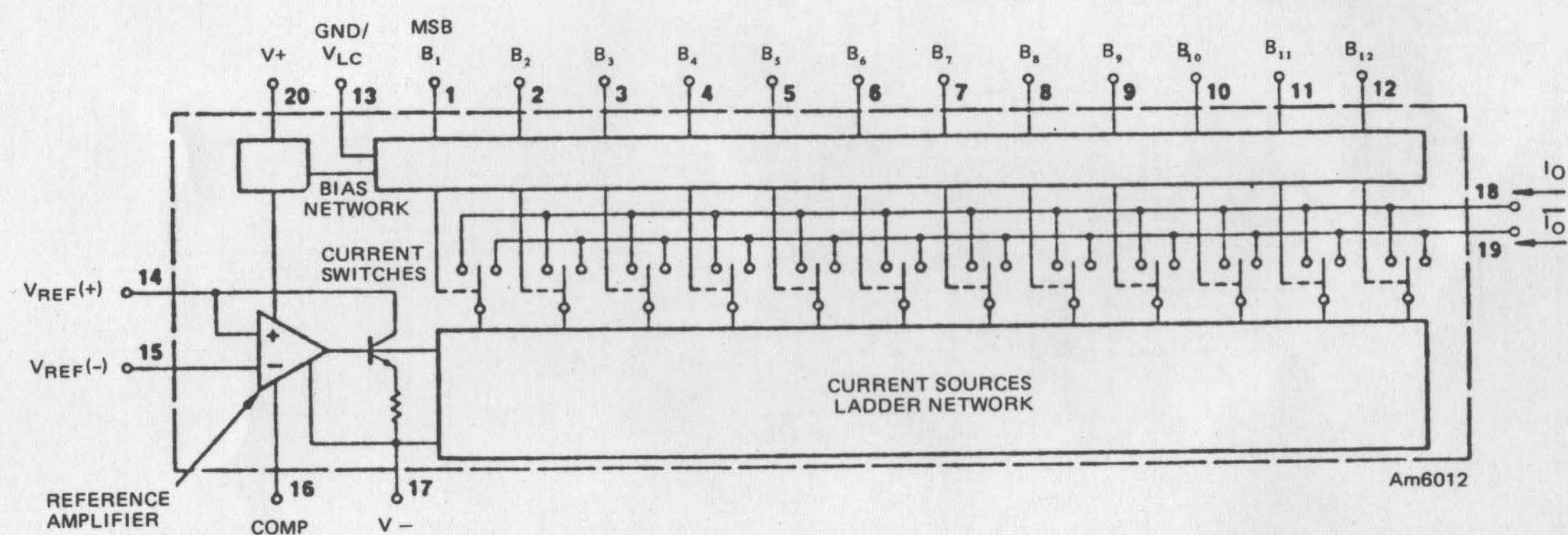

PIN CONFIGURATION

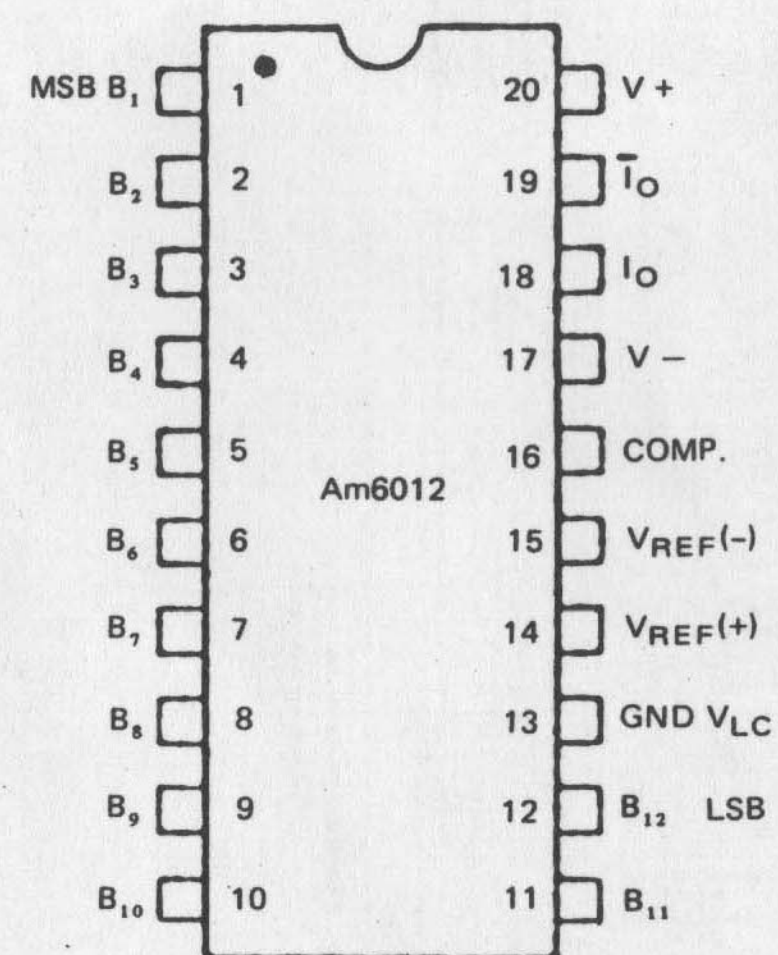

Note:
 Pin 1 is marked
 for operation

IC 8255A-5 PROGRAMMABLE PERIPHERAL INTERFACE

PIN NAMES

D ₇ -D ₀	DATA BUS (BI DIRECTIONAL)
RESET	RESET INPUT
CS	CHIP SELECT
RD	READ INPUT
WR	WRITE INPUT
A ₀ , A ₁	PORT ADDRESS
PA ₇ -PA ₀	PORT A (BIT)
PB ₇ -PB ₀	PORT B (BIT)
PC ₇ -PC ₀	PORT C (BIT)
V _{CC}	+5 VOLTS
GND	0 VOLTS

PIN CONFIGURATION

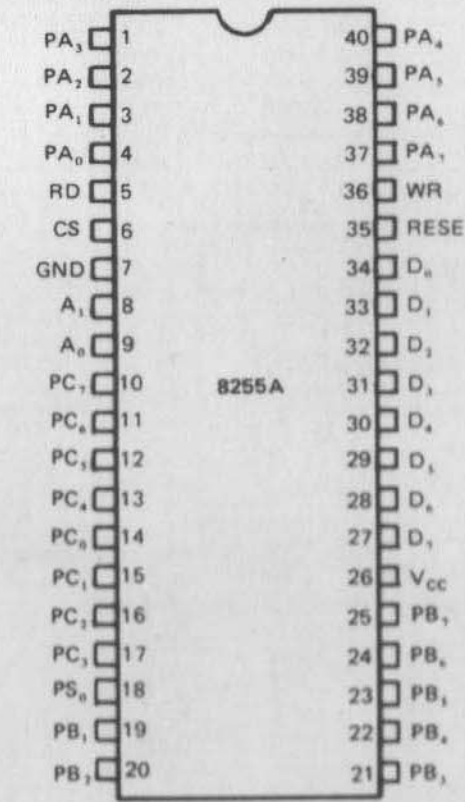

8255A BLOCK DIAGRAM

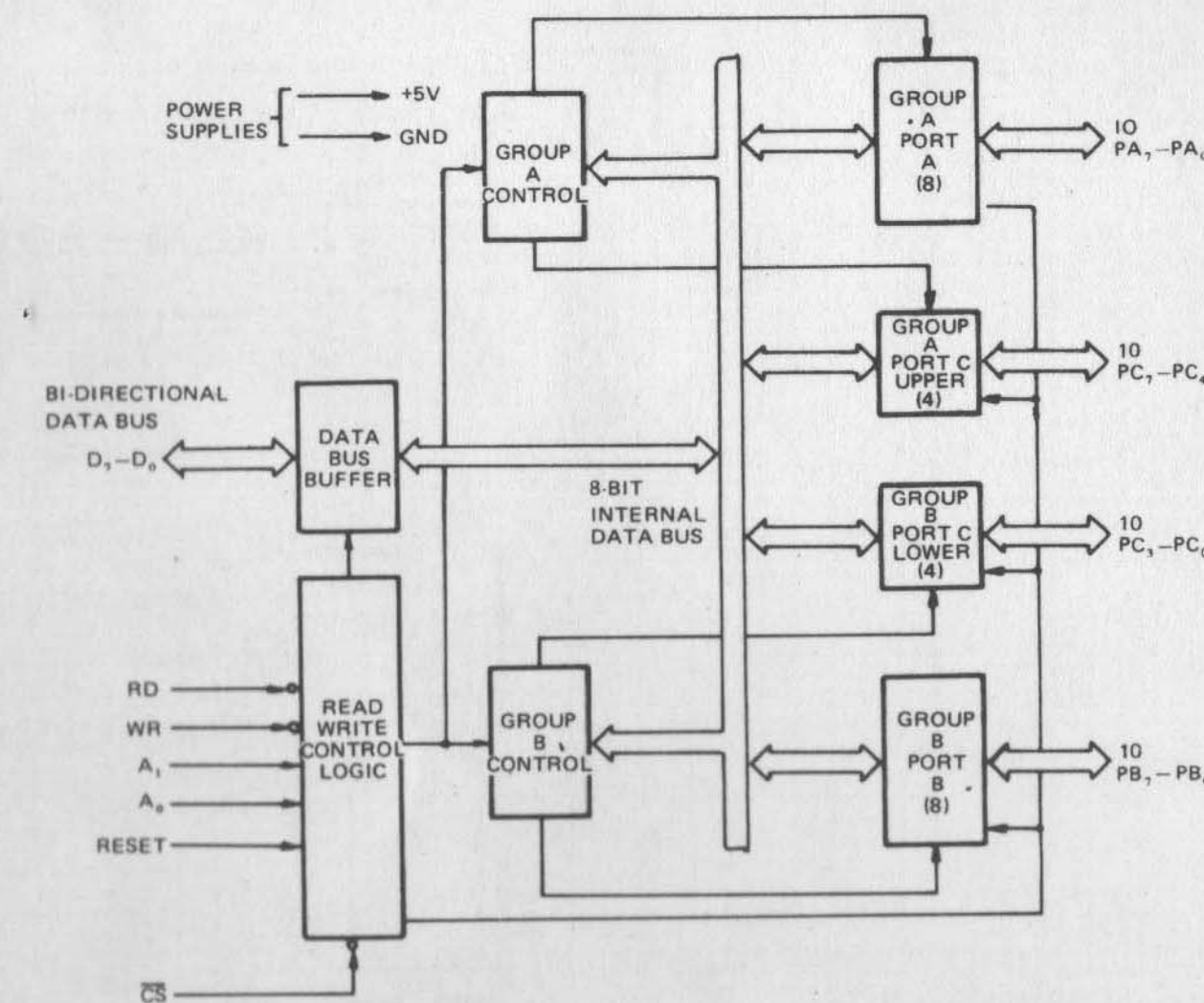

6. PC BOARD

KLM-800

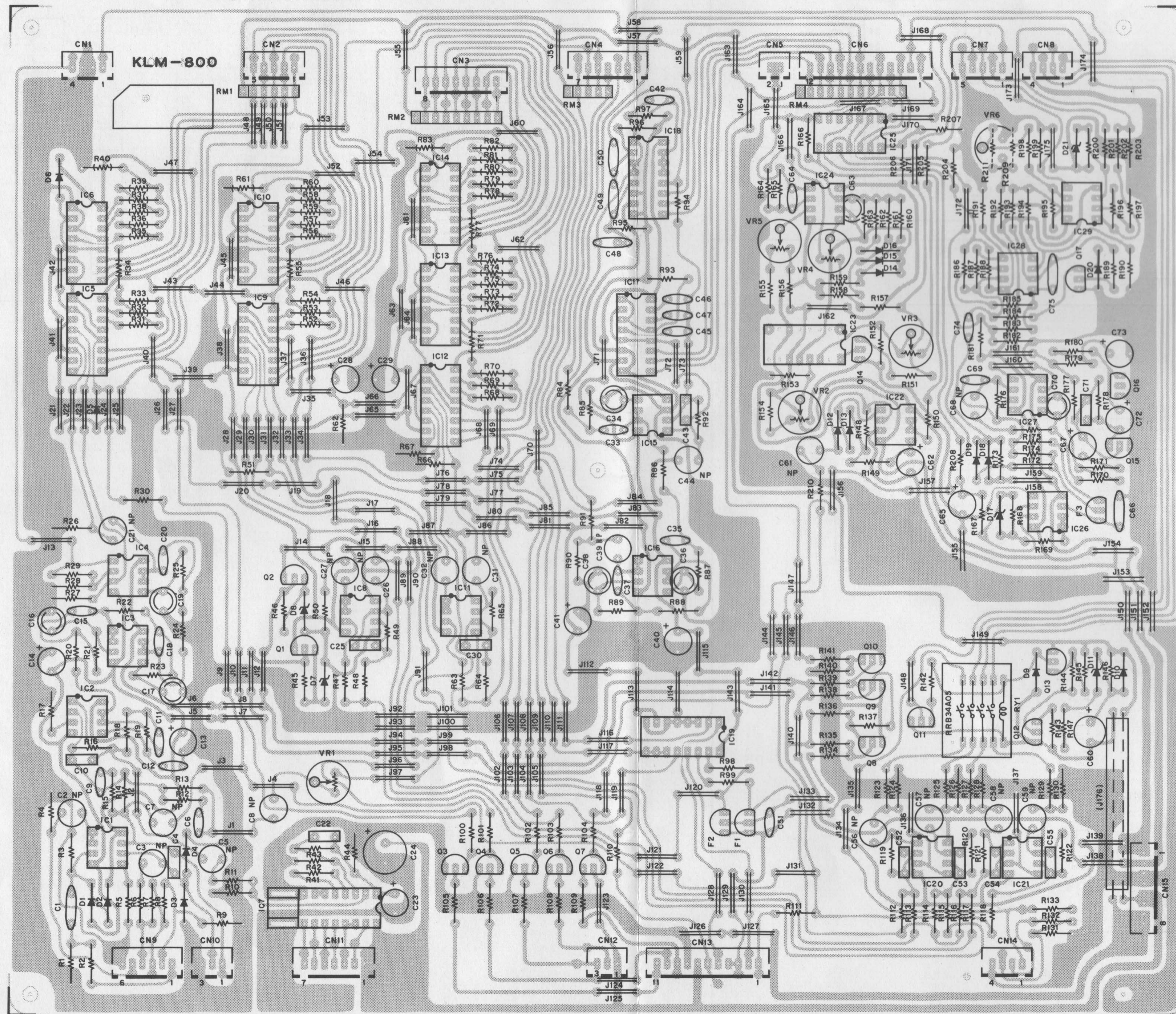

KLM-801

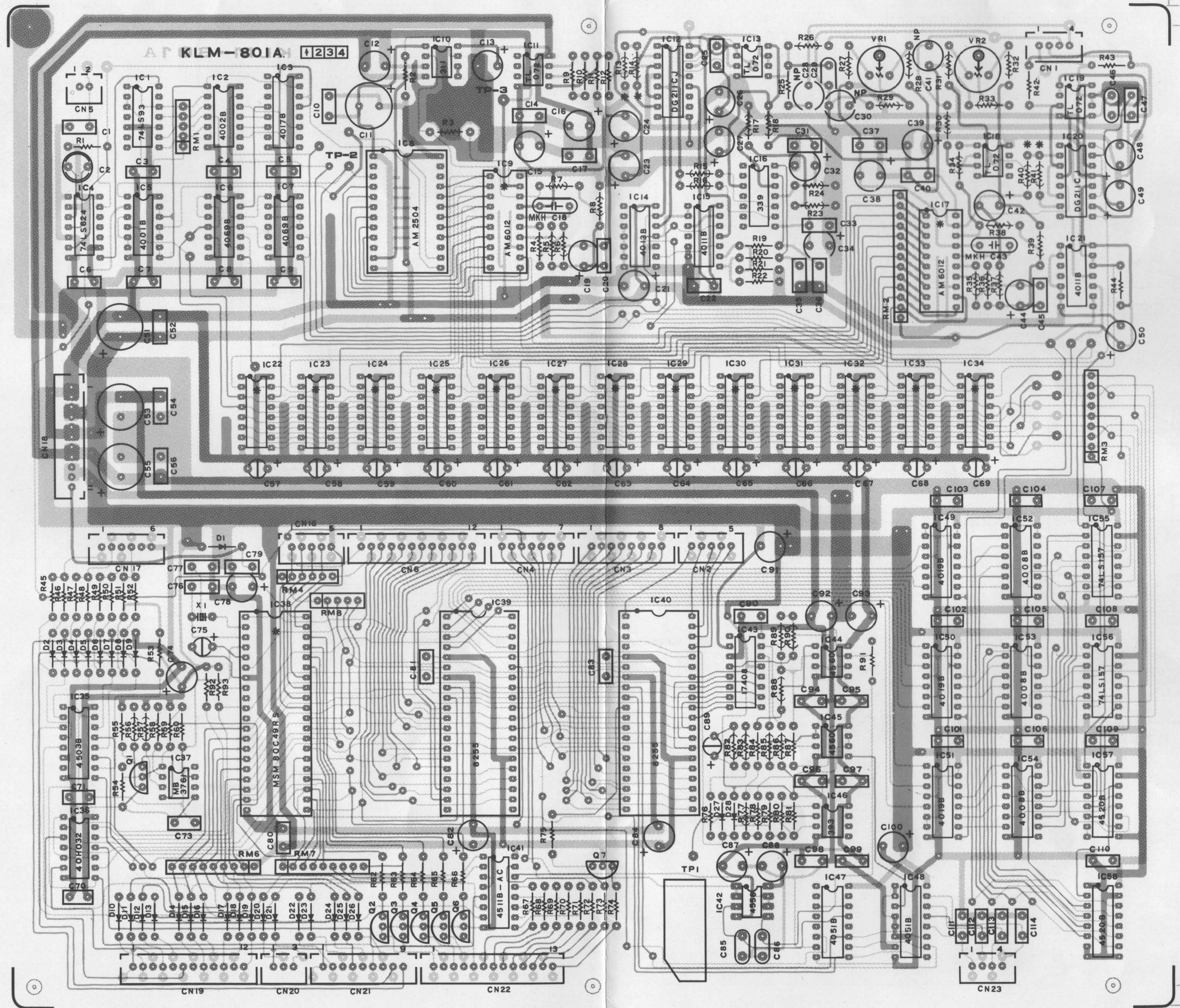

KLM-802

KLM-803

KFW-805

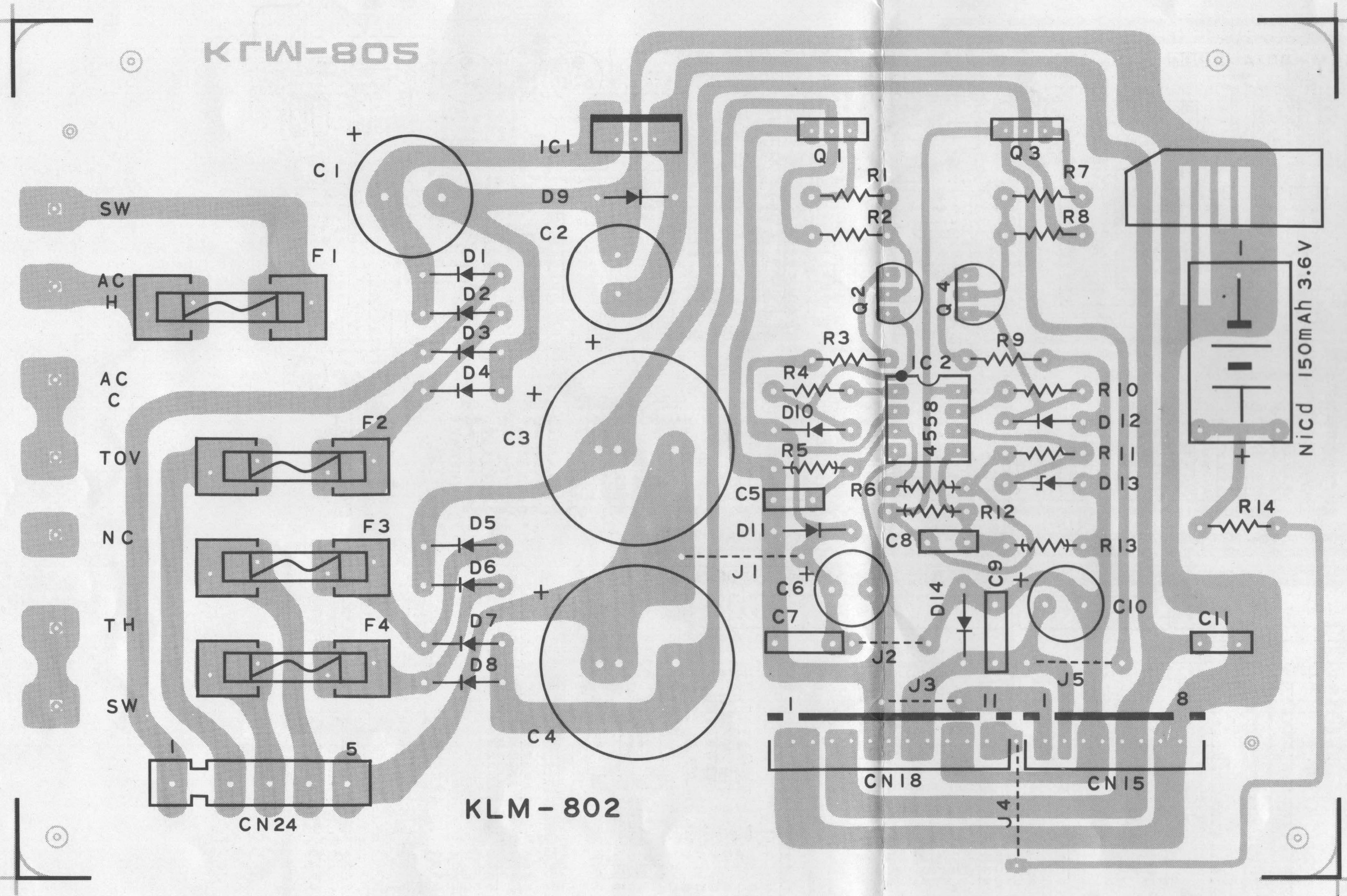

KLM-802

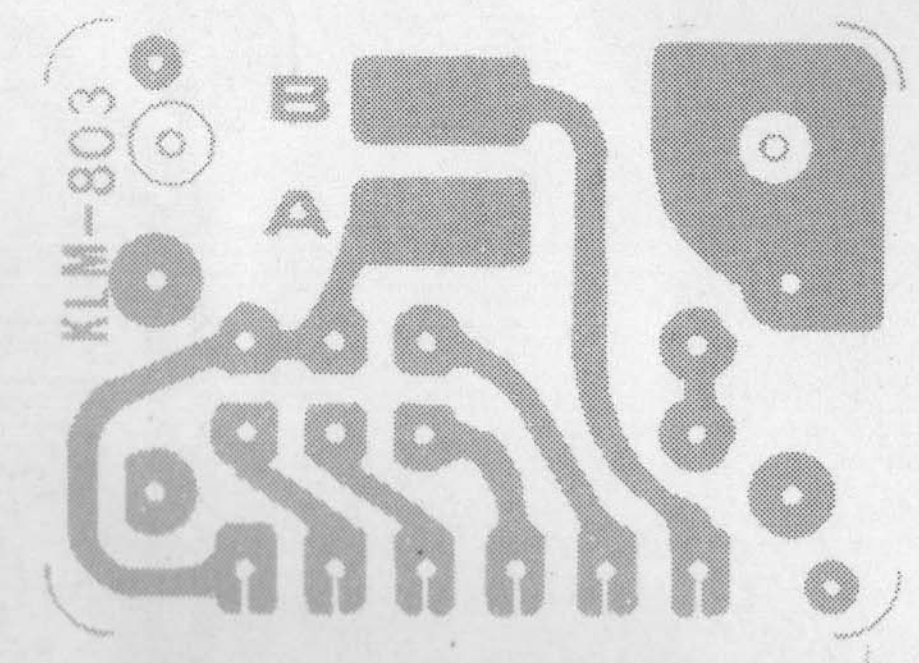

KLM-803

KLM-804

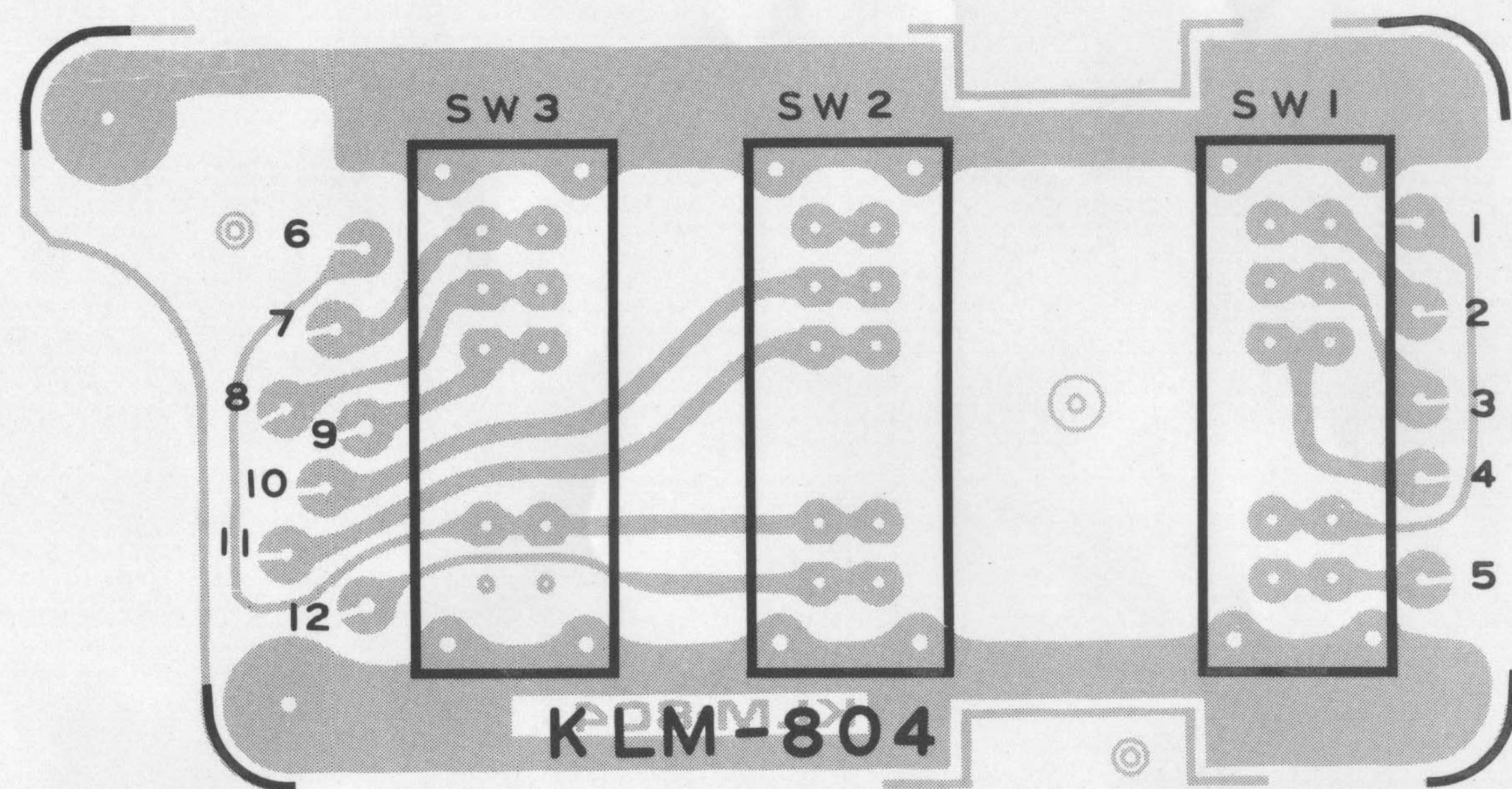

KLM-806

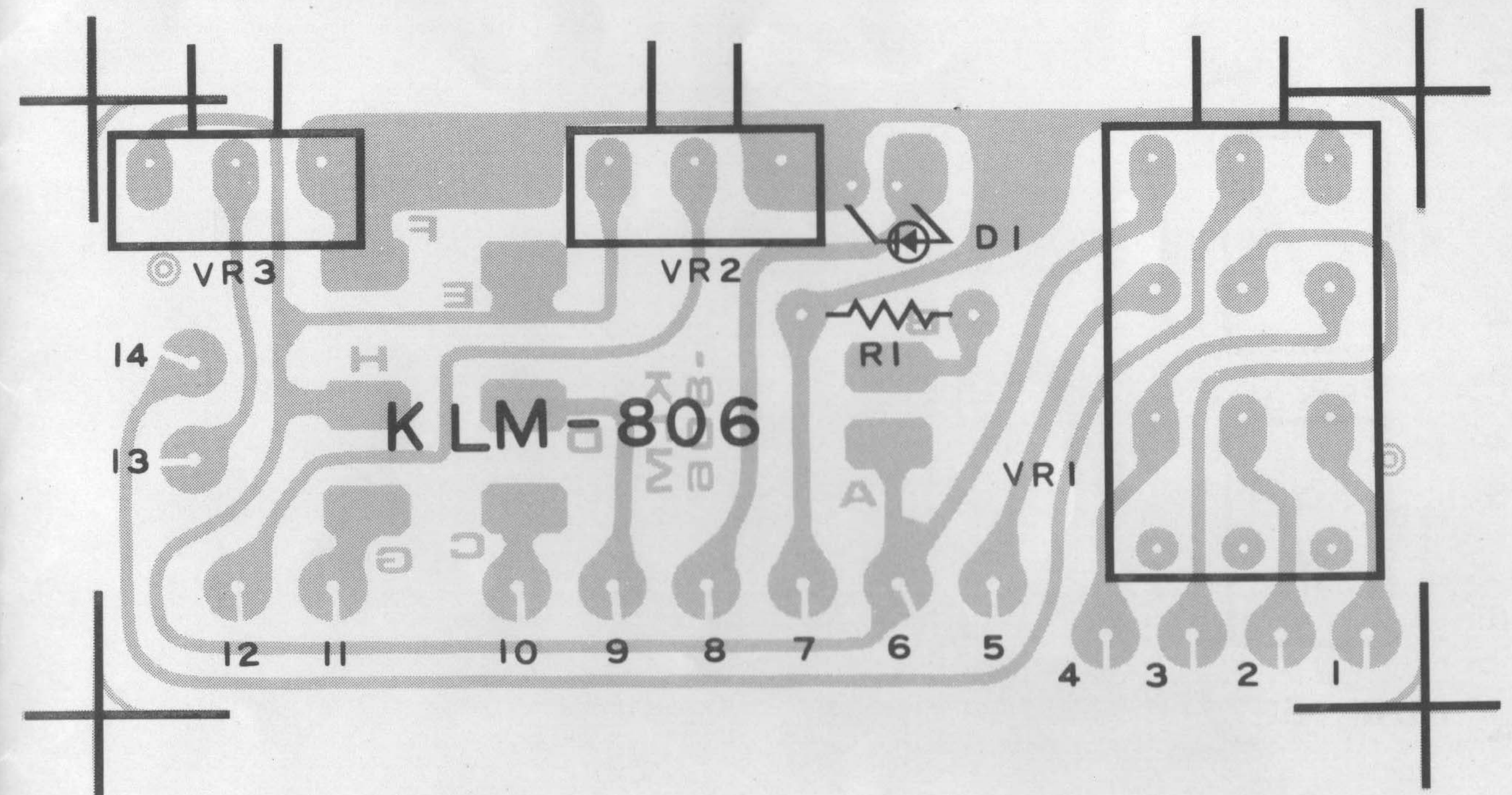

KLM-805

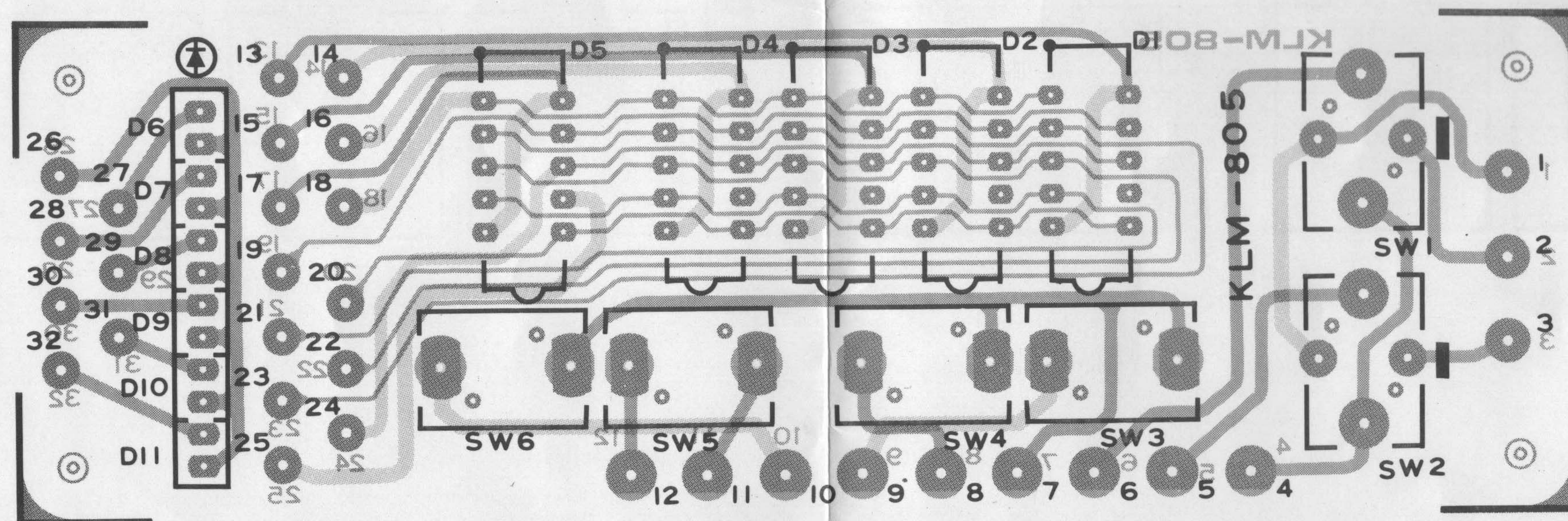

KLM-807

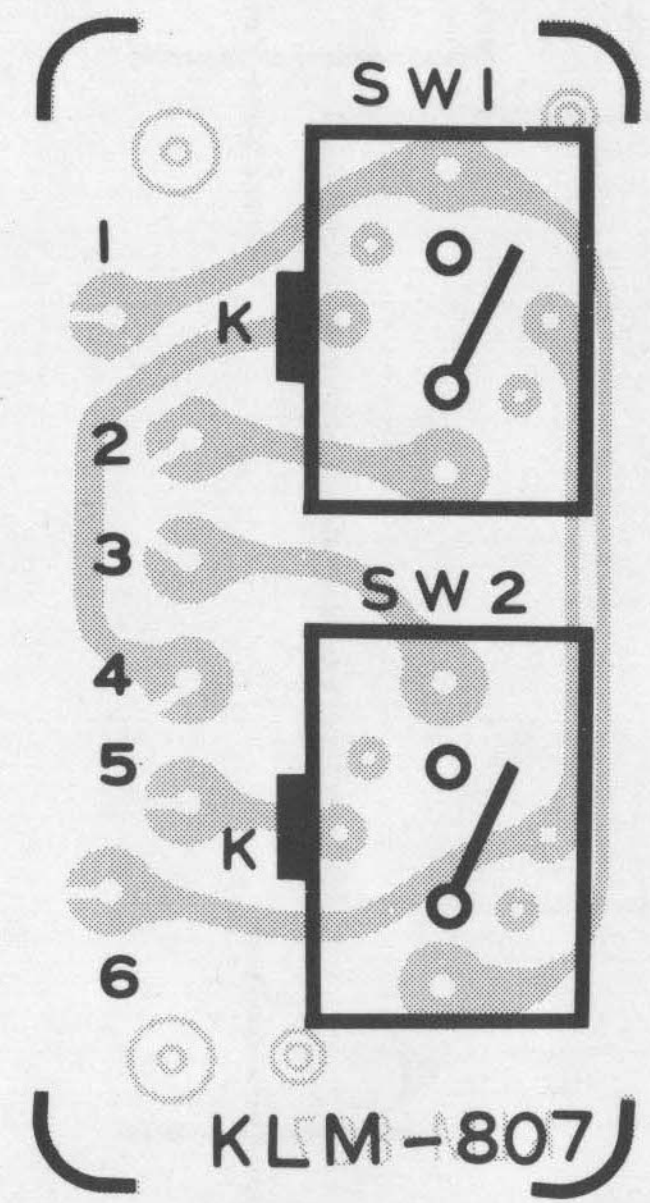

KLM-810

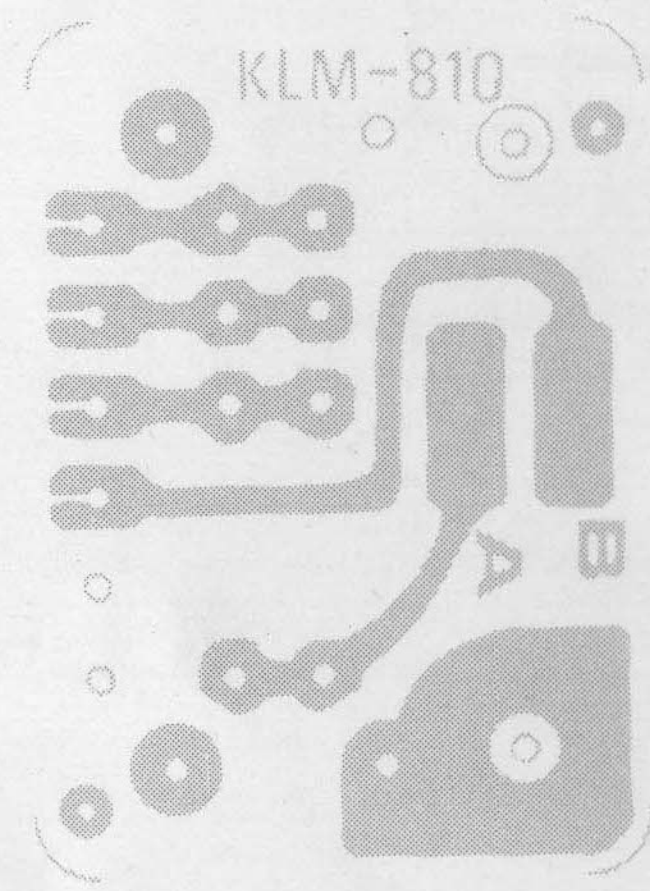

KLM-808

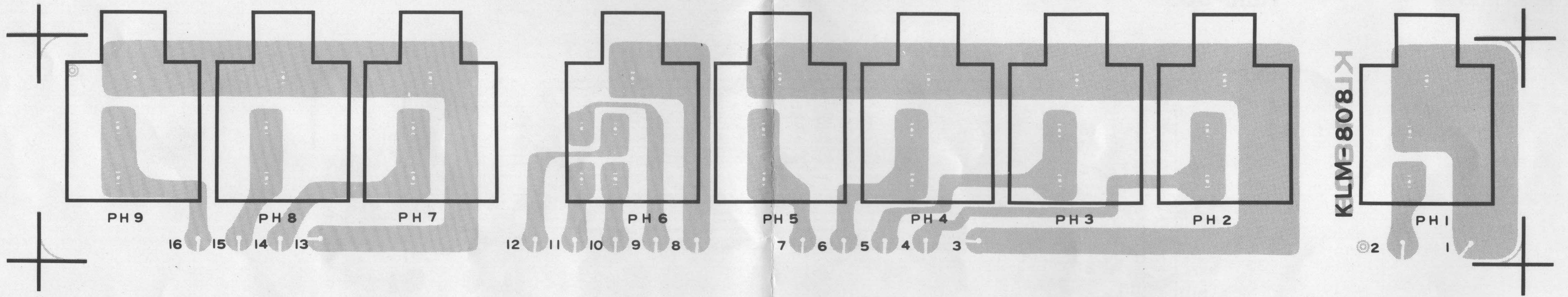

7. CHECK AND ADJUSTMENT PROCEDURE

Caution: This unit has been precisely adjusted at the factory before shipment. Therefore, absolutely do not turn any of the variable resistors other than those required for servicing. Testing and adjustment should be performed only after allowing the unit to warm up for ten minutes. Variable resistor locations are marked on separate charts.

KLM-802 Check

1. Power supply check.

Use DVM (digital voltmeter) to check connectors CN18 and CN15. Confirm that voltages are within specifications listed below.

- 1) +15V +14.25V ~ +15.75V.
- 2) -15V -14.25V ~ -15.75V.
- 3) +5V +4.75V ~ +5.25V.

2. Memory backup battery voltage check.

Turn off power and check using DVM.

- 1) Battery, 3.6V 3.0V ~ 3.65V.

Caution

Be careful not to short circuit the battery. The battery is not usable if voltage is 2.5V or less. Therefore, it is recommended that the battery be replaced if voltage is 2.7V or less.

KLM-801 Check and adjustment

1. Comander.

- 1) Setting: Intensity 0, Frequency 0, Feedback 0, Balance 10, Input ATT +4dB.
- 2) Connect SG (standard signal generator) to SDD-3000. Apply 40Hz, 20Vpp sine wave.
- 3) Connect oscilloscope (2V/div, 10msec/div) to TP3 and observe waveform shown in Fig-1.

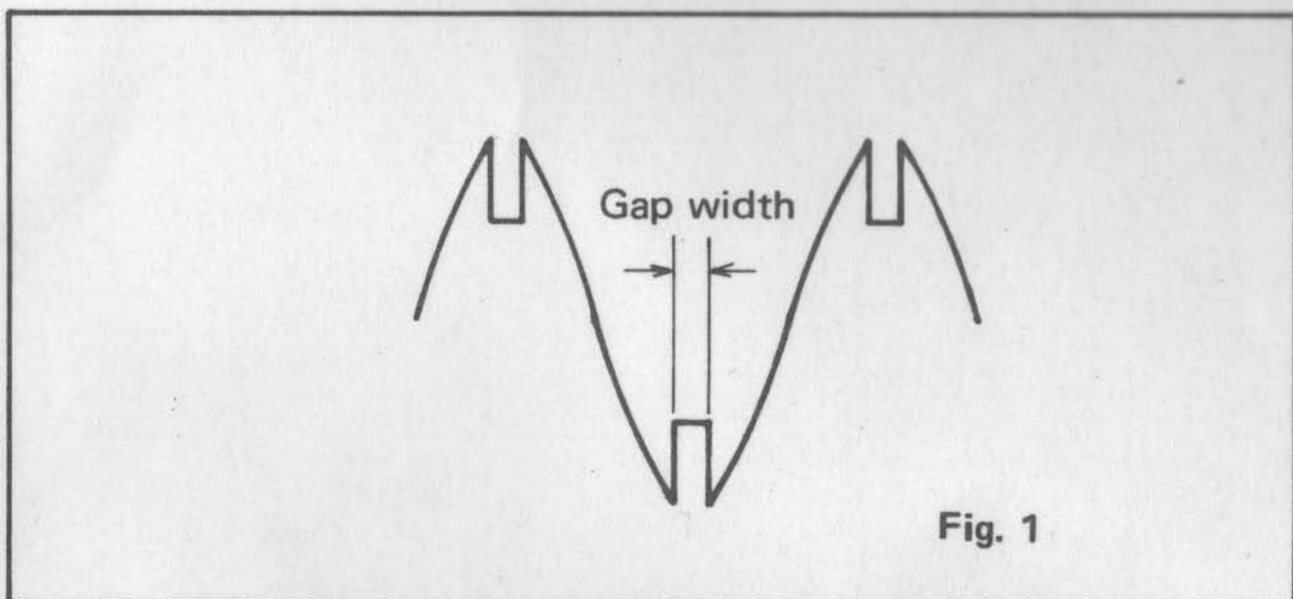

- 4) Adjust input level and confirm symmetrical gap widths for the upper and lower halfwaves as shown in Fig-1.
- 5) Adjust VR1 if there is any deviation.
- 6) Observe output waveform on oscilloscope.
- 7) Raise oscilloscope sensitivity to enlarge sections of the waveform where there were gaps. Confirm that there are no notches as shown in Fig-2.

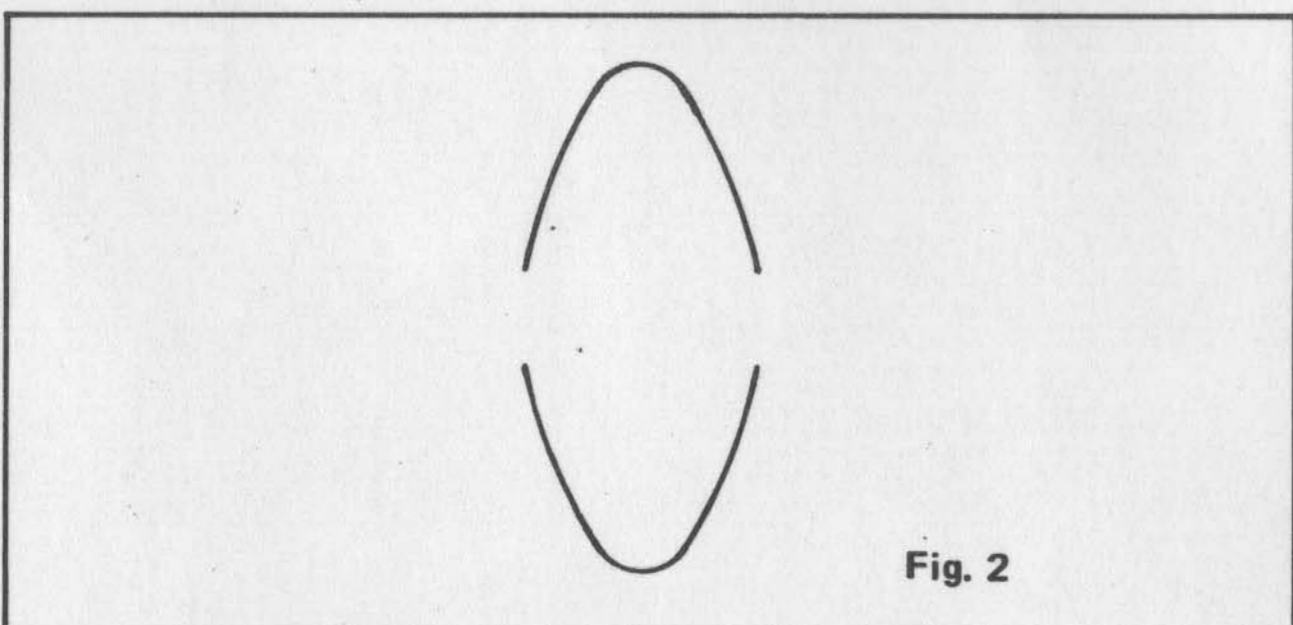

- 8) If there are notches, adjust VR2.

KLM-800 Check and adjustment

1. LFO Frequency.

- 1) Setting: Modulation intensity 10, Frequency 0, Waveform .
- 2) Connect frequency counter to KLM-850 J165. (IC24 1PIN) Confirm 10sec ±2sec. Adjust VR6 if there is any deviation.
- 3) Next, set Frequency to 10 and confirm counter reading of 16Hz ±2Hz.
- 4) Confirm that LED flashes in time with LFO cycle.

2. LFO Waveform.

- 1) Setting: Intensity 10, Frequency 10, Waveform .
- 2) Connect oscilloscope (2V/div, 20msec/div) to KLM-800 J165 (IC24 1PIN) and observe waveform shown in Fig-1.

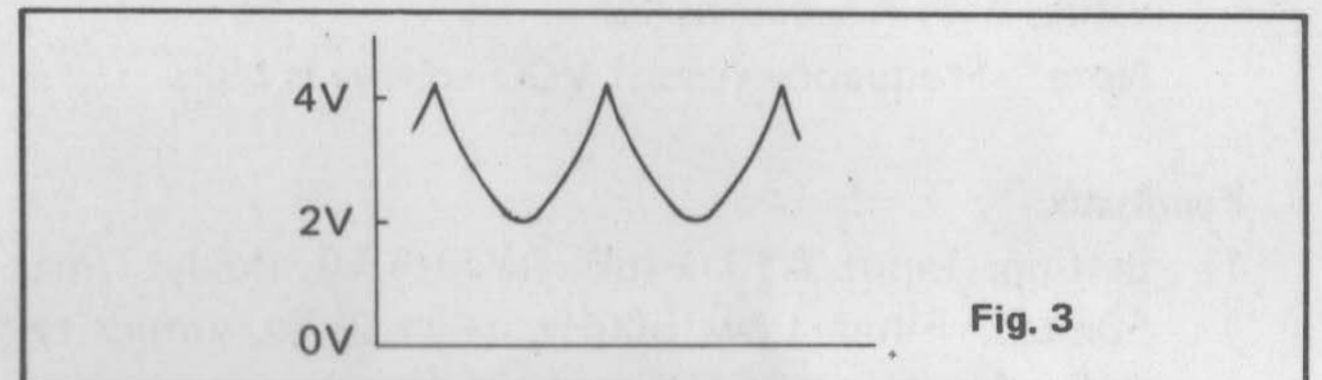

- 3) Adjust rounded bottom of waveform with VR2.
- 4) Adjust upper limit of amplitude with VR3. (About 4V.)
- 5) Adjust lower limit of amplitude with VR4. (About 2V.)
- 6) Set Waveform to and confirm that amplitude is about the same for both the square wave and triangle wave.

3. LFO Waveform RND.

- 1) Setting: Intensity 5, Frequency - varied, Waveform RND.
- 2) Connect oscilloscope (2V/div, 0.2sec/div, DC) to KLM-800 J165. (IC24 1PIN)
- 3) Confirm that the integrated waveform's amplitude is varied at random by the LFO cycle.

4. LFO Waveform ENV.

- 1) Setting: Intensity 10, Frequency 0, Waveform ENV.
- 2) Connect oscilloscope (2V/div, 0.5sec/div) to KLM-800 J165. (IC24 1PIN)
- 3) Set Input ATT to +4dB and Input level to 5. Apply a 100msec pulse to the input and confirm the waveform shown in Fig-2.

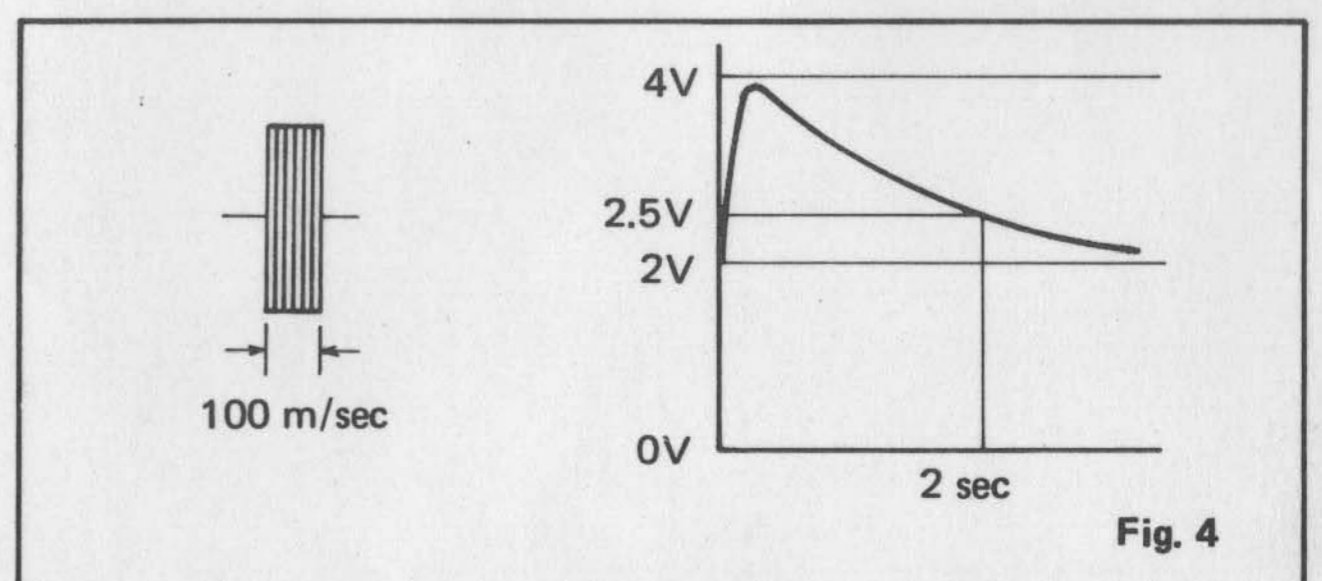

5. Sampling Frequency.

- 1) Setting: Intensity 0, Frequency 0.
- 2) Connect frequency counter to KLM-801 TP2 and confirm 64kHz \pm 2kHz.
- 3) Adjust KLM-800 VR5 if there is any deviation.

6. MOD Sampling Frequency.

- 1) Setting: Intensity 10, Frequency 0, Wave form \square .
- 2) Connect frequency counter to KLM-801 TP2 and confirm that readings are within specifications listed below.

Max: 78kHz \pm 2kHz.

Min: 40kHz \pm 1kHz.

- 3) If there is any deviation adjust KLM-800 VR3 for maximum value and adjust VR4 for minimum value. Repeat adjustments as necessary to bring both values within specifications.

Note: Frequency rises if VCO voltage is high.

7. Feedback.

- 1) Setting: Input ATT +4dB, Balance 10, Delay Time 50msec, Filter Low 500Hz, High 2kHz, Intensity 0, Feedback inv OFF, Feedback 10.
- 2) Use SG to apply a 100msec pulse (Fig-3) to input; confirm oscillation.
Also confirm that there is no oscillation when there is no input (Input level at 0).

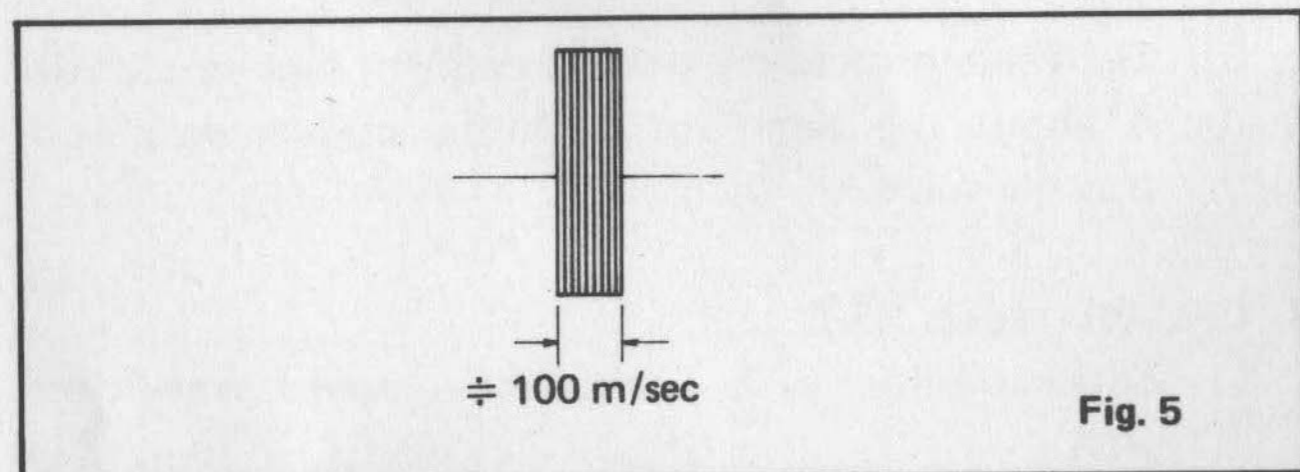

- 3) Adjust VR1 if there is any deviation.
- 4) Set Delay Time to 8msec, LOW and HIGH filters to FLAT, and adjust Feedback to the point just before oscillation.
- 5) Confirm that volume changes when the INV switch is turned on and off.

Note: Phase is inverted when INV switch is ON.

8. PARTS LIST

*CARBON RESISTOR NOT LISTED

PART CODE	PART NAME SPECIFICATIONS	P.C. BOARD	Q'TY
METAL FILM RESISTORS			
12064100	1/8BY 1.00K	KLM-801	2
12064301	1/8BY 3.01K		2
12114511	1/4FY 5.11K	KLM-802	1
12114590	1/4FY 5.9K		2
12115107	1/4FY 10.7K		1
12413100	1/4TP 100Ω	KLM-801	1
12413221	1/4TP 221Ω		1
12413432	1/4TP 432Ω		2
12414100	1/4TP 1.00K		4
12414249	1/4TP 2.49K		7
12414475	1/4TP 4.75K		2
12414499	1/4TP 4.99K	KLM-800	15
		KLM-801	3
12415100	1/4TP 10.0K	KLM-800	21
12415100	1/4TP 10.0K	KLM-801	11
12415121	1/4TP 12.1K		1
12415150	1/4TP 15.0K		1
12415182	1/4TP 18.2K		2
12415340	1/4TP 34K		2
BLOCK RESISTORS			
13504510	RKC1/8B4J 10K	KLM-800	1
		KLM-801	1
13504610	RKC1/8B4J 100K		1
13505510	RKC1/8B5J 10K	KLM-800	1
		KLM-801	1
13508447	RKC1/8B8J 4.7K		1
13508510	RKC1/8B8J 10K	KLM-800	1
		KLM-801	1
13508610	RKC1/8B8J 100K		1
13510510	RKC1/8B10J 10K	KLM-800	1
13512510	RKC1/8B12J 10K	KLM-801	1
MYLAR CAPACITORS			
20003547	50V 0.047UFK	KLM-800	2
		KLM-801	2
20003582	50V 0.082UFK	KLM-800	1
20003610	50V 0.1UFK		4
20401410	50V 0.001UF J		6
		KLM-801	2
20401415	50V 0.0015UF J	KLM-800	2
20401427	50V 0.0027UF J		2
20401433	50V 0.0033UF J		1
20401447	50V 0.0047UF J		1
20401456	50V 0.0056UF J		2
20401468	50V 0.0068UF J		1
20401510	50V 0.01UF J		2
STYROL CAPACITORS			
20502318	50V GT 180PF	KLM-801	1
20503312	50V JT 120PF	KLM-800	1
20503322	50V JT 220PF	KLM-800	1
20503333	50V JT 330PF		3
20503368	50V JT 680PF		3
CERAMIC CAPACITORS			
21238610	25V 0.1UF	KLM-802	3
21256322	50V 220PFJ		1
21256333	50V 330PF		1
21441500	50V 5PF	KLM-800	6
		KLM-801	1
21442100	50V 10PF	KLM-800	2
		KLM-801	2
21442220	50V 22PF		1
21442470	50V 47PF	KLM-800	2

PART CODE	PART NAME SPECIFICATIONS	P.C. BOARD	Q'TY
21443100	50V 100PF	KLM-801	1
			1
21443330	50V 330PF		2
21446100	25V 0.1UF		48
SPARK KILLER			
21900300	PME265MC 533		1
TANTALUM CAPACITORS			
22424110	25V 1UF	KLM-801	14
22425022	35V 0.22UF		1
ELECTROLYTIC CAPACITORS			
23404410	A10V 1000UF	KLM-802	1
23407210	A16V 10UF	KLM-801	20
23407222	A16V 22UF		1
23407233	A16V 33UF		2
23407247	A16V 47UF	KLM-800	7
		KLM-801	6
23407322	A16V 220UF	KLM-800	1
		KLM-801	4
		KLM-802	2
23407347	A16V 470UF		1
23407422	A16V 2200UF		2
23413422	B35V 2200UF		4
24507247	A16V 47UF RBP	KLM-800	3
24511147	A25V 4.7UF RBP	KLM-800	11
24511210	A25V 10UF RBP	KLM-801	2
24515110	A50V 1UF RBP		1
25013210	16V 10UF	KLM-800	4
25016110	50V 1UF		1
25016147	50V 4.7UF		1
MKT CAPACITORS			
27308610	100V 0.1UF	KLM-801	2
TRANSISTORS			
30000727	2SA733 AK	KLM-802	1
30000799	2SA733 AK SELECTED	KLM-800	1
30100328	2SB744A P/Q	KLM-802	1
30200327	2SC945 AK		1
30300528	2SD794A P/Q		1
30400010	2SA733A K	KLM-800	3
		KLM-801	5
30400030	2SA952A K	KLM-800	1
30420010	2SC945A K		11
		KLM-801	2
30420040	2SC2001 K	KLM-800	1
FET			
30460011	2SK30A TM-GR		3
DIODES			
31000100	1S1555	KLM-802	2
31400100	1S1555 TP	KLM-800	15
31400100	1S1555 TP	KLM-801	27
31000200	1S1885	KLM-800	1
		KLM-801	1
		KLM-802	11
ZENER PICODES			
31101300	RD 5.1EB2		1
31420100	RD 8.2EB-TN-B2	KLM-800	2
31420200	RD 5.1EB-TN-B2		3
LED			
31201400	PR 3932S	KLM-806	1
31201600	BG5531	KLM-805	5

PART CODE	PART NAME SPECIFICATIONS	P.C. BOARD	Q'TY
31201700	PR5531		1
31250100	TLR312		1
31250200	TLG312-E/F		4
IC			
32001043	UPD-8255AC-5	KLM-801	2
32001045	UPD-4511B-AC		1
32002019	AN-6878	KLM-800	1
32003043	TC-40H032P	KLM-801	1
32204004	HD-14066 BP	KLM-800	1
32004006	HD-14520 BP	KLM-801	2
32004007	HD-14001 BP		1
32004008	HD-14011 BP		2
32004009	HD-14013 BP		1
32004017	HD-14051 BP		2
32004019	HD-14069 UBP		2
32004021	HD-14503 BP		1
32004030	HA-17408P		1
32004036	HD-14002BP		1
32004037	HD-14008BP		3
32004038	HD-14017BP		1
32004039	HD-14053BP	KLM-800	10
32004040	HD-14519BP	KLM-801	3
32004042	HM-4864P-3		13
32006008	MSM-80C49RS		1
32009001	NJM-4558D-V	KLM-800	14
		KLM-801	1
		KLM-802	1
32009006	NJM-4560 D	KLM-801	2
32009011	NJM-7805 A	KLM-802	1
32009012	NJM-311D	KLM-801	1
32009013	NJM-13600 D	KLM-800	1
32012001	MB-3761 M	KLM-801	1
32021006	LM-339 N		1
32021011	TL-072	KLM-800	2
		KLM-801	4
32021017	LM-393-N		1
32021036	SN-74LS624		1
32021037	SN-74LS157		2
32021038	SN-74LS93P		1
32034001	AM2504PC		1
32034002	AM6012PC		2
32035001	DG211CJ		2
CERAMIC OSCILLATORS			
33500900	EFO-A6R0M01		1
PC BOARD			
34080000	KLM-800	KLM-800	1
34080101	KLM-801	KLM-801	1
34080200	KLM-802	KLM-802	1
34080300	KLM-803	KLM-803	1
34080400	KLM-804	KLM-804	1
34080500	KLM-805	KLM-805	1
34080600	KLM-806	KLM-806	1
34080700	KLM-807	KLM-807	1
34080800	KLM-808	KLM-808	1
34081000	KLM-810	KLM-810	1
SEMI-FIXED RESISTORS			
35201222	H1051A 2.2KB	KLM-800	3
35201310	H1051A 10KB		1
35201322	H1051A 22KB		1
35201410	H1051A 100KB		1
35202310	H1021A 10KB	KLM-801	2

PART CODE	PART NAME SPECIFICATIONS	P.C. BOARD	Q'TY
ROTARY VR			
36014900	K161100GKC 10KB		1
36015000	K161100GKC 100KB		1
36015100	K161100LCC 10KA	KLM-806	1
36015200	K161100LCC 10KB		1
36203400	K164A0011A 20KBX4		1
SLIDE SW			
37301900	ESD-32108	KLM-803	1
		KLM-810	1
37303800	ESD-32110	KLM-804	3
POWER SW			
37504700	SDGA 3P		1
TACT SW			
37504800	KEC-10010	KLM-805	4
37504900	KEC-11903		2
		KLM-807	2
POWER TRANSFORMERS			
40007700	TA-800	100V UNI JAM 117 2P	1 1 1 1
40007800	TB-800	220 GE 220 SE 240 AF 240 AU DEMKO SEMKO NEMKO 240 GE 220 FR	1 1 1 1 1 1 1 1 1
RELAY			
40300500	RRB34A05	KLM-800	1
PHONE JACK			
45401400	HLJ-4305-01-030	KLM-808	1
45401500	HLJ-4305-01-100		8
45401600	HLJ-0607-01-100		2
FUSE			
46402501	125V 3A UL	100V UNI JAM 117 2P	1 1 1 1
46411701	250V 0.5A UL	100V UNI JAM 117 2P	1 1 1 1
46412003	250V 1.0A UL	100V UNI JAM 117 2P	2 2 2 2
46461701	250V T500MA	220 GE 220 SE 240 AF 240 AU DEMKO SEMKO NEMKO 240 GE 220 FR	3 3 3 3 3 3 3 3 3
46462201	250V T1.6A	220 GE 220 SE	1 1

PART CODE	PART NAME SPECIFICATION	P.C. BOARD	Q'TY
46462201	250V T1.6A	240 AF 240 AU DEMKO SEMKO NEMKO 240 GE 220 FR	1 1 1 1 1 1 1
HARNESS			
47090000	HNS-800		1
47090100	HNS-801		1
47090200	HNS-802		1
47090300	HNS-803		1
47090400	HNS-804		1
47090500	HNS-805		1
47090600	HNS-806		1
47090700	HNS-807		1
47090800	HNS-808		1
47090900	HNS-809		1
47091000	HNS-810		1
47091100	HNS-811		1
47091200	HNS-812		1
47091300	HNS-813		1
47091400	HNS-814		1
47091500	HNS-815		1
47091600	HNS-816		1
47091700	HNS-817		1
47091800	HNS-818		1
47091900	HNS-819		1
47092000	HNS-820		1
47092100	HNS-821		1
CONNECTOR TOP			
47130200	B2B-XHA	KLM-800 KLM-801	1 1
47130300	B3B-XHA	KLM-800 KLM-801	2 1
47130400	B4B-XHA	KLM-800 KLM-801	3 2
47130500	B5B-XHA	KLM-800 KLM-801	2 2
47130600	B6B-XHA	KLM-800 KLM-801	1 1
47130700	B7B-XHA	KLM-800 KLM-801	2 1
47130800	B8B-XHA	KLM-800 KLM-801 KLM-802	2 1 1
47130900	B9B-XHA	KLM-801	1
47131100	B11B-XHA	KLM-800 KLM-801 KLM-802	1 1 1
47131200	B12B-XHA	KLM-800	1
47131300	B13B-XHA	KLM-801	2
IC SOCKET			
48005162	16P C471611	KLM-801	13
48005202	20P C472011		2
48005402	40P C474011		1
BUFFER OF COVER			
50005200	KOC-F48003		2
FUSE HOLDER			
51501600	S-N5053 #01	KLM-802	8

PART CODE	PART NAME SPECIFICATION	P.C. BOARD	Q'TY
BATTERY			
52000900	3/170DK (3.6V 170MAH)		1
BUSHING			
54000300	SR-4K-4	100V UNI 117 2P	1 1 1
54000400	SR-5P-4	JAM 240 AU	1 1
54000500	SR-6W-1	220 GE 220 SE 240 AF DEMKO SEMKO NEMKO 240 GE 220 FR	1 1 1 1 1 1 1 1
TEST PIN			
54007100	LC-2-G-YELLOW	KLM-801	3
CORD BAND			
54007600	No. 113		1
GND TERMINAL			
54007700	T-10		1
JAMPER CORD			
54502000	SMV2J-B7/0.16X2X70	KLM-800	1
SW MASK			
55004800	A 23X12 KOC-F48001		2
55004900	B 28X12 KOC-F48001		3
55005000	C 20X14 KOC-F48002		1
RADIATION MASK			
55005100	120X105 KOC-F48006		1
RADIATION BOARD			
56002300	SDD-3000 KOC-C48000	KLM-802	1
SHIELDING SHEET			
58017000	B 100X70 KOC-F48005		1
58017100	C 280X280 KOC-F48007		2
58017200	D KOC-F48009		1
58017300	E KOC-F48011		1
AC CORD			
60000101	KE1044 0.75SQ 2.5M	100V	1
60000200	SPT-2 18AWG/2 2.5M	UNI 117 2P	1 1
60000300	CLASS1H05VV-F3X0.75	220GE DEMKO SEMKO NEMKO 240 GE 240 AU	1 1 1 1 1 1
60000400	SAA 3X0.75 2.5M	240 AF	1
60000500	240AF 2.5M GRAY	JAM	1
60000600	SVT 18AWGX3 2.5M	220 SE	1
60000900	SEV 2.5M GRAY	220 FR	1
60001300	KP4819D 3X0.75 2.5M		1
ROTARY VR KNOB			
62010900	RITEL 27-15-603		5
TACT SW KNOB (BLACK)			
62011000	KT-8		4

PART CODE	PART NAME SPECIFICATION	P.C. BOARD	Q'TY
POWER SW KNOB			
62011100	SUE55102 SDGA		1
TACT SW KNOB (RED)			
62011202	KOC-E48001		1
TACT SW KNOB (YELLOW)			
62011204	KOC-E48001		1
TACT SW KNOB (GRAY)			
62011208	KOC-E48001		2
KNOB CAP (GRAY)			
62910901	RITEL 30-15-111		1
KNOB CAP (YELLOW)			
62910902	RITEL 30-15-16		4
FRONT PANEL			
64057500	KOC-C28001		1
FRONT FRAME			
64057600	KOC-C28000		1
MAIN FRAME			
64057700	KOC-C28002		1
COVER A			
64057800	KOC-C28002		1
COVER B			
64057900	KOC-C28003		1
SPACER D			
64058300	3.2X6X5.5 C48007		4
LED FILTER			
64609700	KOC-E48000		1
SPACER A			
64611100	KOC-E48003		2
RUBBER FEET			
64904400	25X25X4.5 KOC-F48000		4
MODEL NUMBER PLATE			
68600700	KOC-C40424	UNI	1
		JAM	1
		117 2P	1
		220 GE	1
		220 SE	1
		240 AF	1
		240 AU	1
		DEMKO	1
		SEMKO	1
		NEMKO	1
		240 GE	1
		220 FR	1