

Moog™ Synthesizer ACCESSORY OPERATION MANUAL

by Tom Rhea



Table of Contents:

The MOOG™ ACCESSORY CONCEPT	1
1121 FOOT SWITCH	7
1120 PEDAL CONTROL SOURCE	9
1130 DRUM CONTROLLER	11
1150 RIBBON CONTROLLER	17
1125 SAMPLE AND HOLD	21

the MOOG™ ACCESSORY CONCEPT

The devices we use to play and control musical instruments tend to define the limits of the music produced. For example, the *keyboard* historically has excelled in the playing of *stepped* pitches, and is so used on the modern synthesizer. The concept of keyboard *glide*, and use of the keyboard to control elements of sound other than pitch are innovative uses of the keyboard with the synthesizer.

Now, Moog™ Synthesizer Accessories offer the musician alternatives to traditional keyboard control of the synthesizer; these different modes of control open horizons for a new music. The 1150 Ribbon Controller provides *stepless* control over sound; the 1130 Drum Controller facilitates the performance of complex rhythms and opens the world of pitch to the drummer; the 1125 Sample and Hold Accessory creates random or repetitive patterns of

sound that are otherwise unplayable; the 1120 Pedal Control Source acts as an expression pedal, wah-wah or tone control pedal, and pitch bender; the 1121 Foot Switch offers control over portamento (glide) and articulation.

Moog Synthesizer Accessories open the world of the synthesizer not only to the keyboard player, but to *every* interested musician — making the synthesizer the province of the entire musical group.



moog™
MUSIC, INC.

'THE FIRST SOUND IN SYNTHESIZERS'

Some Synthesizer Theory

A *synthesizer* contains elements that are *voltage-controlled*. For example, the pitch, loudness, and tone color of a sound may be determined by the application of *control voltages*. These control voltages may be generated and connected from internal sources such as modulation oscillators, contour generators, keyboard, etc., or from *external* sources such as Moog Synthesizer Accessories. Moog Accessories do not *produce* sounds — they generate control voltages that *control* sounds produced by the synthesizer.

Moog Synthesizers are *open* systems — they allow the introduction of control voltages from the “outside world” (Accessories) to control important elements of sound. Some Moog Synthesizers provide separate external control input jacks for independent external control of pitch (OSCILLATOR), loudness (VOLUME), and tone color (FILTER).

EXTERNAL CONTROL INPUTS

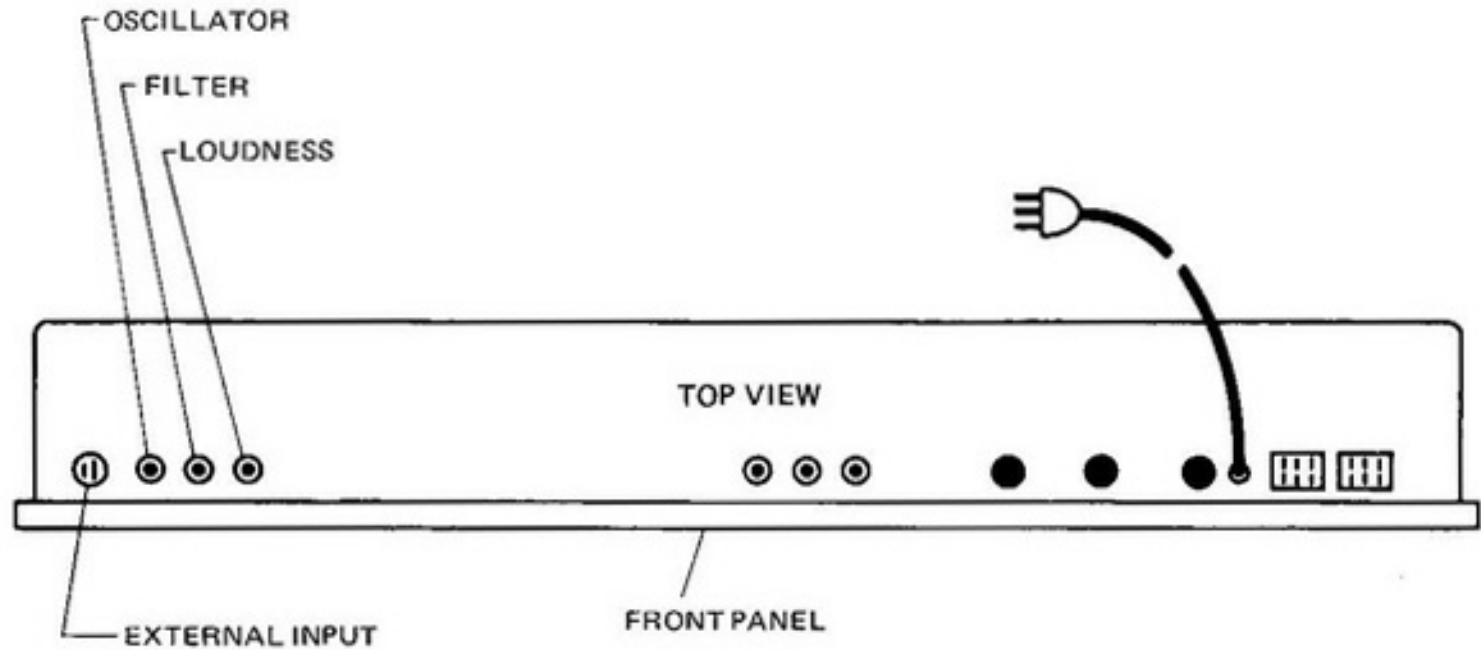

Minimoog, Model D Input Panel

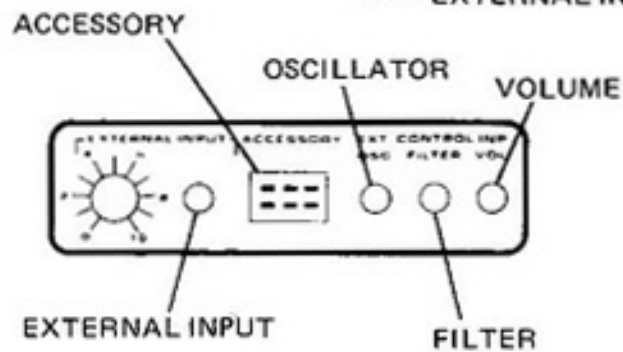

Moog Sonic Six Input Panel

Voltages routed to these external control inputs act as "unseen hands" that electrically manipulate *internal* control elements as one might do manually on the control panel. The following depicts the relationship between the external control inputs and control by hand:

RELATIONSHIPS BETWEEN EXTERNAL AND MANUAL CONTROLS.

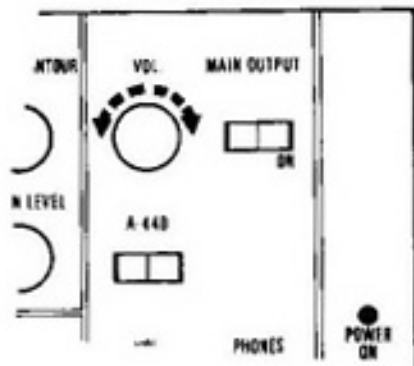
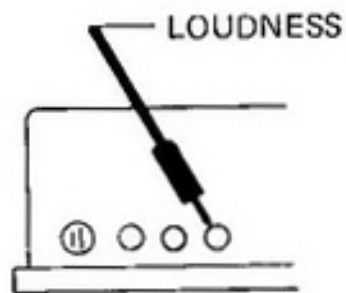

Minimoog **LOUDNESS** control

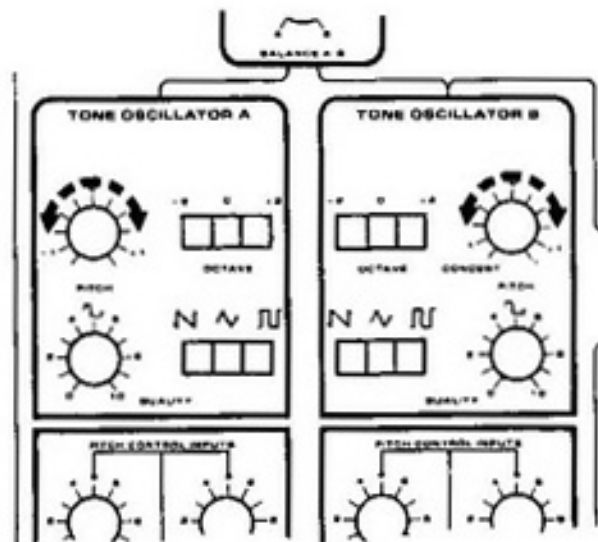
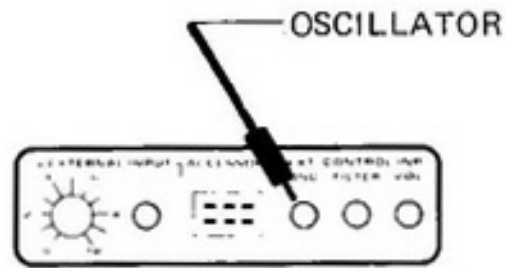

Sonic Six **OSCILLATOR** control

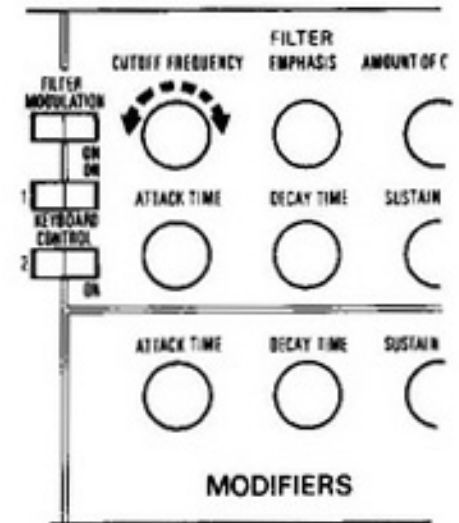
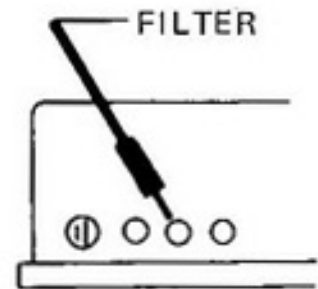

Minimoog **FILTER** control

Control voltages applied from internal sources such as the keyboard, *add* to control voltages applied to the external control inputs. This makes it possible, for instance, to use the Moog Accessories and the keyboard together.

Some Accessories also produce a *trigger* signal that may be used to articulate sound; these Accessories provide functions similar to the *keyboard*. When the keyboard is struck, *two* signals are generated: (1) a *control voltage* that may dictate the pitch of the oscillators; and (2) a *trigger* that starts the action of the contour generator(s), creating articulations. The trigger produced may be an "S-Trigger" — *switch* trigger, or a "V-Trigger" — *voltage* trigger, depending on which Moog synthesizer is in use. Accessories that produce triggers are designed to supply *both* types of triggers.

Accessories that produce control voltages *and* triggers are often called *controllers*; examples include the 1130 Drum Controller, 1150 Ribbon Controller, and the 1125 Sample and Hold Accessory. The 1120 Pedal Control Source produces no triggers; the 1121 Foot Switch acts only as a switch, and produces neither triggers nor control voltages.

Moog Accessories offer useful new means of triggering and controlling sounds produced by the synthesizer.

PRACTICAL OPERATION PROCEDURES

Basic directions for use are found on the underneath side of each MoogTM Accessory. Control voltages are routed from Accessories via *phone plugs*. S-Triggers are routed via the two-prong plug; V-Triggers via the six-prong plug.

Accessory Connection Procedure

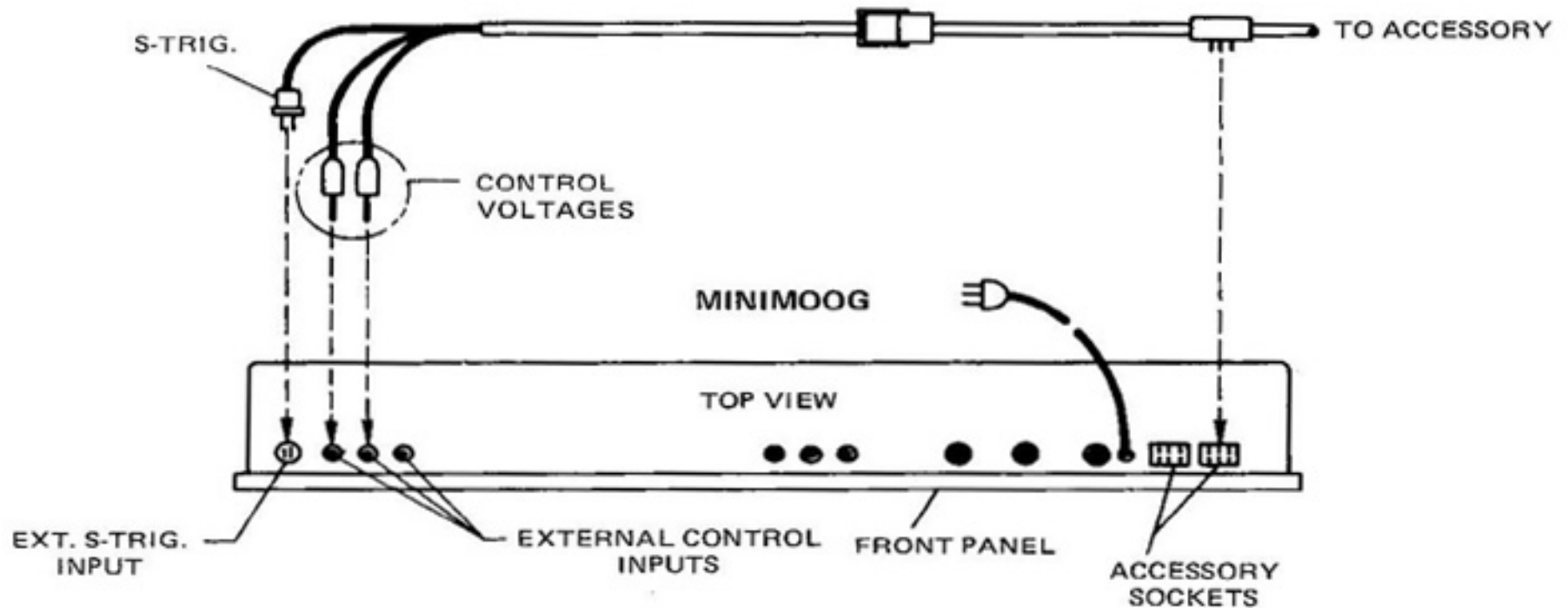

1. Plug the six-prong plug to the ACCESSORY socket on the synthesizer; this powers the accessory and routes a *trigger* to the synthesizer on some models.

2. Plug the two-prong plug into the S-TRIG socket on appropriate models such as the MINIMOOG™.

3. Plug phone jacks into the appropriate external control inputs to provide control over the various aspects of sound.

4. Set up a sound on the synthesizer control panel; it is convenient to “test” the sound by striking the keyboard before using the Accessory.



1121 FOOT SWITCH

The 1121 Foot Switch generates neither control voltages nor triggers; it is used with the MINIMOOG Synthesizer as a switch.

1121 Foot Switch Features

The 1121 Foot Switch is a heavy duty industrial-grade *momentary* switch. That is, it acts to turn a particular function on only so long as it is depressed. The plug on the output cable mates with the jacks to the *left* of the GLIDE and DECAY switches on the MINIMOOG. It is slightly smaller than the standard ¼" phone plugs found on the other Moog Accessories to prevent improper use with control and audio jacks.

Directions For Use

1. Plug the cable from the 1121 into the DECAY or GLIDE switch inputs on the left-hand controller section of the MINIMOOG.
2. Place the corresponding DECAY or GLIDE rocker switch to the *left* – in the *off* position.
3. Depress the 1121 Foot Switch to momentarily turn the DECAY or GLIDE function ON during performance.

Applications

ARTICULATION EFFECTS

When the DECAY switch on the MINIMOOG is off, and no 1121 Foot Switch is used, final decays will be abrupt (15 msec). When the DECAY switch is ON, final decays will be determined by the DECAY TIME control on the LOUDNESS CONTOUR. When the DECAY switch is off and the 1121 Foot Switch is in place, depressing the switch has the same effect as turning the DECAY switch ON. Various DECAY TIME settings may be tried to achieve different articulation effects when the 1121 Foot Switch is used.

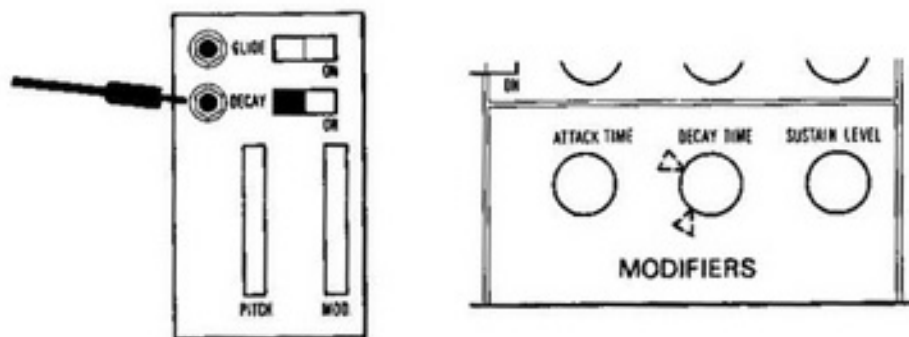

MINIMOOG

SUSTAIN PEDAL

When the 1121 is used with the DECAY switch and fairly long (800 msec and longer) settings of the DECAY TIME control are used, the 1121 functions as a sustain pedal.

PORTAMENTO/GLIDE CONTROL

When the 1121 is used with the GLIDE switch, glide between notes may be introduced by depressing the 1121 Foot Switch. The amount of glide is controlled by the GLIDE control in the CONTROLLERS section of the MINIMOOG. The 1121 allows the momentary use of glide for expressive portamento effects.

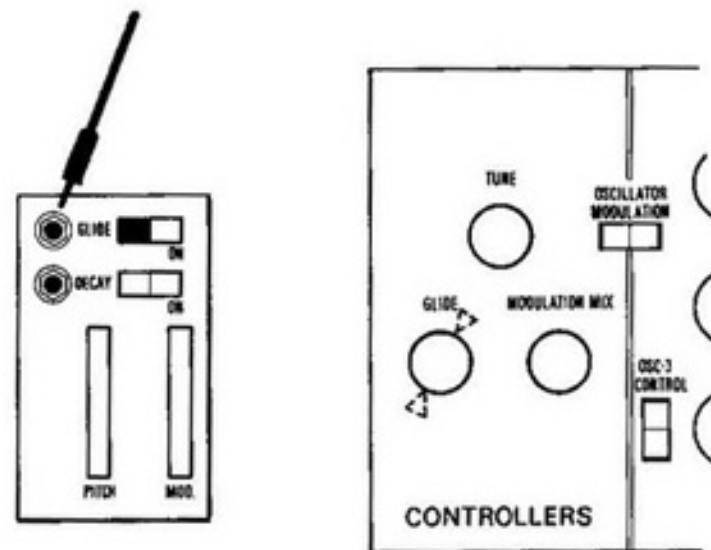

MINIMOOG

1120 PEDAL CONTROL SOURCE



The 1120 Pedal Control Source is a source of a continuously variable voltage that may be used to control the synthesizer. The 1120 produces no triggers, and is usually used with a trigger-producing device such as the keyboard.

1120 Pedal Control Source

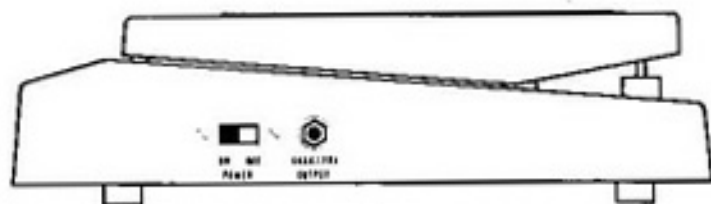

The power source of the 1120 is a 9-volt battery (NEDA 1604). The battery will last for more than 3000 hours (five months) of use, but the POWER switch should be turned off when pedal is not in use to prolong battery life. The battery may be replaced by removing the bottom cover of the 1120.

The output voltage is determined by an attenuator attached to the pedal mechanism; the span is from 0 to 4.5 volts, with 0 volts at the fully back, heel-down position.

The AUXILIARY OUTPUT jack supplies the same control voltage as the output cable. A guitar patchcord may be used to connect the AUXILIARY OUTPUT to a *second* control input on the synthesizer, and *two* synthesizer functions may be controlled simultaneously.

The 1120 is a *control* device for use with voltage-controlled musical instruments; do *not* plug any signal source, guitar output, microphone, or instrument pickup into the AUXILIARY OUTPUT jack.

Directions for Use

1. Plug the output cable from the 1120 into one of the EXTERNAL CONTROL INPUTS (FILTER, LOUDNESS, OSCILLATOR) of the synthesizer.
2. Turn the POWER switch of the 1120 on.
3. Use the pedal with a triggering device such as the **keyboard**.

Applications

PITCH BENDER

The 1120 Pedal Control Source acts as a wide-range pitch bender when connected to the OSCILLATOR control input. The control voltage from the 1120 *raises* pitch from the level set by panel controls as the pedal is pressed forward.

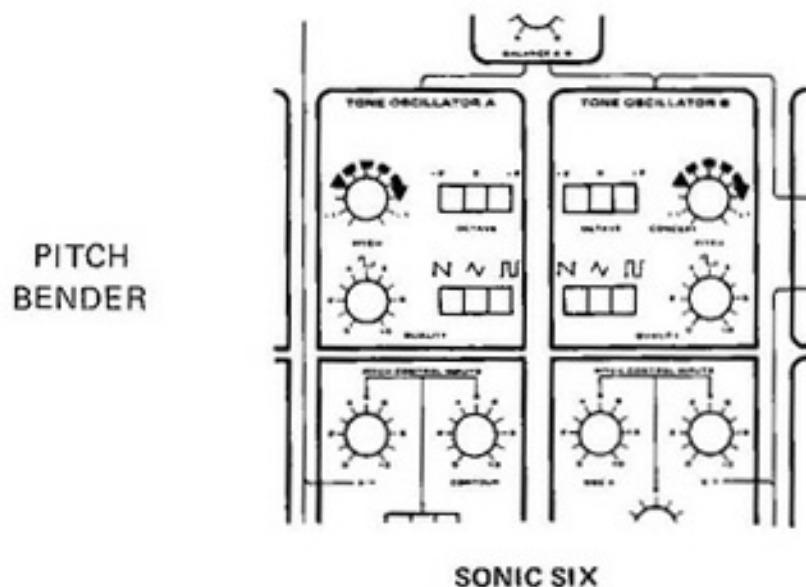

PITCH
BENDER

For practical use, tune the pitch level of the synthesizer with the 1120 Pedal fully back or fully forward, depending on which way you wish to bend pitch. This assures easy and certain return to the initial pitch level.

TONE CONTROL/WAH-WAH PEDAL

When connected to the FILTER control input, the 1120 acts to *raise* the cutoff frequency of the filter above the point set by the manual CUTOFF FREQUENCY control.

TONE
CONTROL/
WAH-WAH
PEDAL

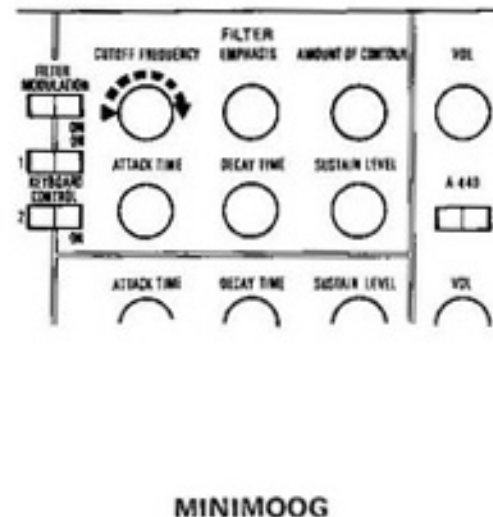

For best results set the CUTOFF FREQUENCY control fairly low; at low EMPHASIS (RESONANCE) settings, the foot pedal functions as a tone control. At high EMPHASIS (RESONANCE) settings, the 1120 acts like a "wah-wah" pedal.

EXPRESSION PEDAL

The 1120 acts as a volume or "expression" pedal when connected to the LOUDNESS, or VOLUME control input. The 1120 varies the synthesizer loudness over a dynamic range from silence (pedal fully back) to a *maximum* loudness set by the synthesizer master volume control.

EXPRESSION
PEDAL

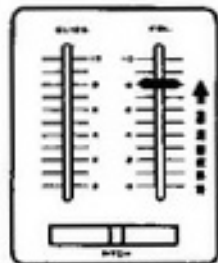

SONIC SIX

The setting of the master gain control on the synthesizer therefore determines the sensitivity of pedal control. Very low master VOLUME settings produce a very narrow span from silence to maximum loudness; large pedal movements produce little change in dynamics. Each performer can experiment with settings of the synthesizer volume controls and his amplifier controls to get the best balance between sound quality and pedal sensitivity.

1130 DRUM CONTROLLER



The 1130 Drum Controller is a drum which is modified with extensive electronic circuitry. It produces triggers (both "S" and "V") and discrete control voltage changes each time the head is struck.

1130 Drum Controller Features

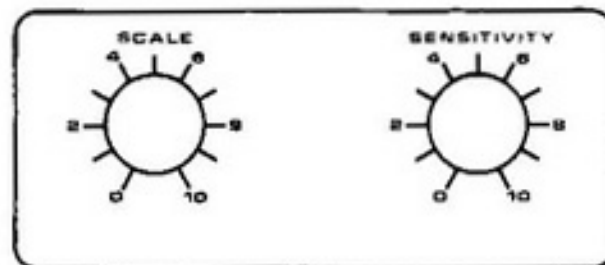

The 1130 is an electro-acoustical transducer that produces a short trigger and a control voltage change when the drum head is struck. The vibration of the head is damped so that only a dull thud will be heard when the head is struck. The actual *sound* of the impact is transduced to produce a control voltage proportional to the loudness. This control voltage and trigger are then used to control a sound produced by the synthesizer. The harder the drum is struck, the higher the control voltage produced. If oscillators are controlled, their pitch will be raised as the drum is struck progressively harder.

The *black* phone plug always delivers the full control voltage. The red plug delivers the same control voltage, but it may be attenuated (lessened) using the SCALE control on the side of the drum shell.

When the SCALE control is at 10, the *full* control voltage is delivered to the red plug; at 0, *none* of the control voltage is delivered to the red plug. The black plug is *not* affected by the SCALE control.

The two-prong plug provides an S-Trigger for use with models such as the MINIMOOG. The V-Trigger is available through the six-prong plug and appropriate models are wired to receive this trigger through the ACCESSORY socket.

The SENSITIVITY control sets the threshold of strike force required to produce a trigger. At 0, no trigger will be produced regardless of how hard the head is struck. At 10, a trigger will be produced most easily. Each performer may set the SENSITIVITY control to fit his individual sticking technique.

Play the 1130 Drum Controller with sticks, mallets, or hands.

Directions for Use

1. Plug the six-prong plug into the ACCESSORY socket on the synthesizer.
2. On models having an S-Trig input socket, insert the two prong plug in the S-TRIG socket.

3. For constant pitch tones, insert the black phone plug in the LOUDNESS jack and the red phone plug in the FILTER jack.

For variable pitch tones, insert the black plug in the FILTER jack and the red plug in the PITCH jack.

4. Turn both SCALE and SENSITIVITY controls to 10.
5. Set up a percussive sound (shortest ATTACK and intermediate DECAY) on the synthesizer and test by striking a key. On MINIMOOG, turn DECAY switch ON. The 1130 produces a very *short* trigger when struck. The LOUDNESS CONTOUR on the MINIMOOG will respond only when its ATTACK TIME is very short. Models such as the SONIC SIX use another type of Contour Generator which will respond to extremely short triggers *regardless* of the ATTACK setting.
6. Avoid placing the 1130 near the speakers. The transducer within the drum may be triggered by loud sounds. If accidental triggering by loud sounds occurs, turn the SENSITIVITY control on the 1130 down.
7. Use the 1130 Drum Controller to control the synthesizer.

Applications

PITCH CONTROL

One of the most exciting uses of the 1130 is in the control of *pitch*. Connect the 1130 as indicated in Directions for Use for variable pitch tones and place the SENSITIVITY and SCALE controls to 10.

MINIMOOG

Controlling parallel chords with the 1130 Drum Controller. (Fine tune Oscillator-2 and Oscillator-3 to produce a major chord.)

The 1130 may be used to control all tone oscillators simultaneously to produce parallel chords. Set up a chord on the synthesizer's oscillators:

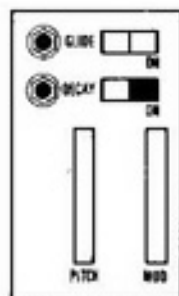
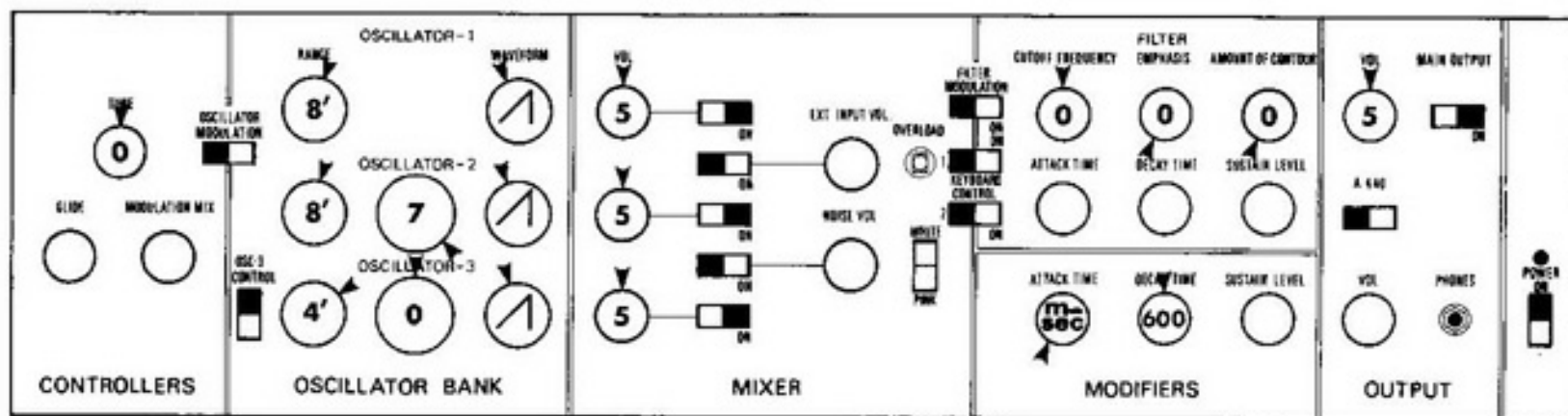

Note that, on the MINIMOOG, the OSCILLATOR-3 will not be controlled by the 1130 Drum Controller when the OSCILLATOR-3 CONTROL switch is off (down).

In this case, OSCILLATOR-3 may be used as a drone while OSCILLATOR-1 and OSCILLATOR-2 may be moved in parallel by the 1130.

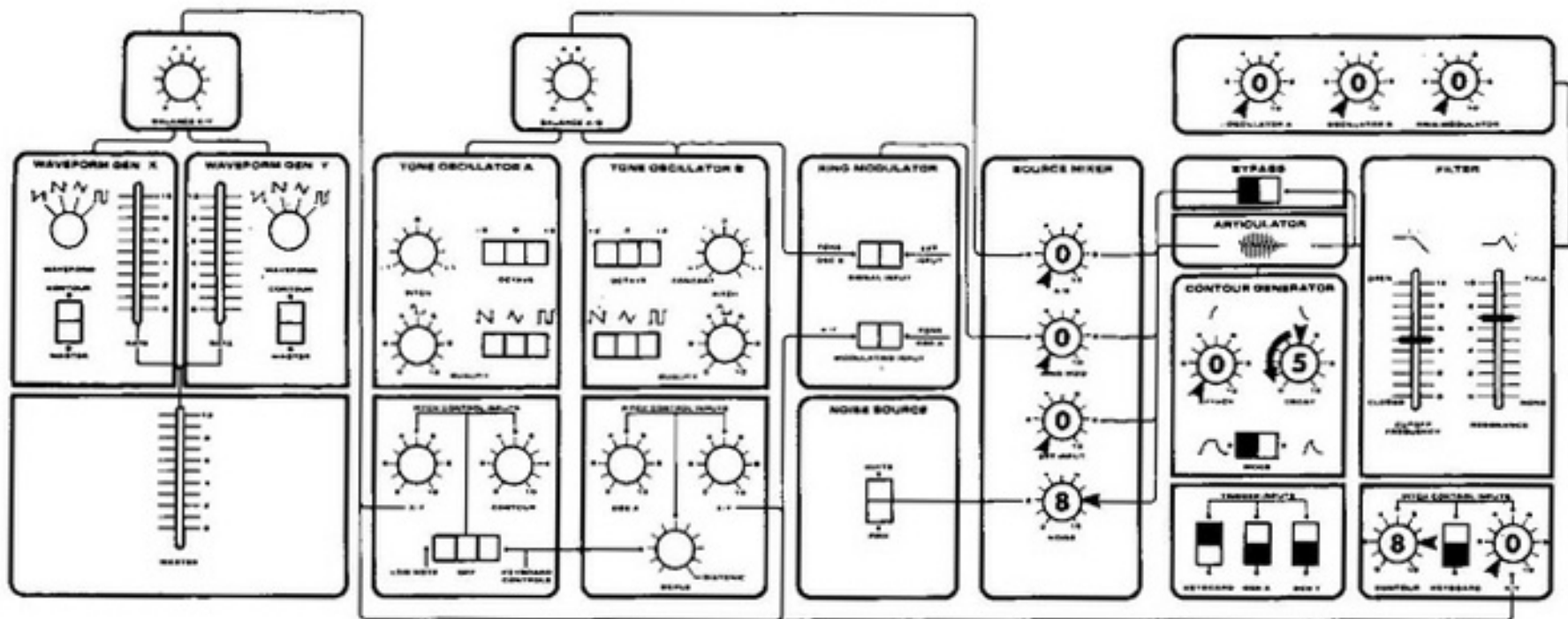

SONIC SIX

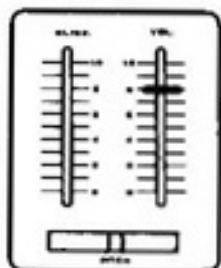

NOISE EFFECTS

The 1130 may be used to control *any* of the sound sources available on the synthesizer. Place the black phone plug into the FILTER jack and use NOISE at the sound source as indicated:

REPEATING PATTERNS

The 1130 may be used to trigger and control the more complex sounds of which the synthesizer is capable; try this setting on the MINIMOOG:

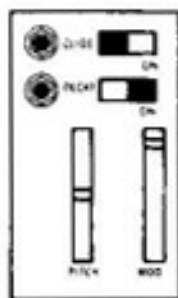
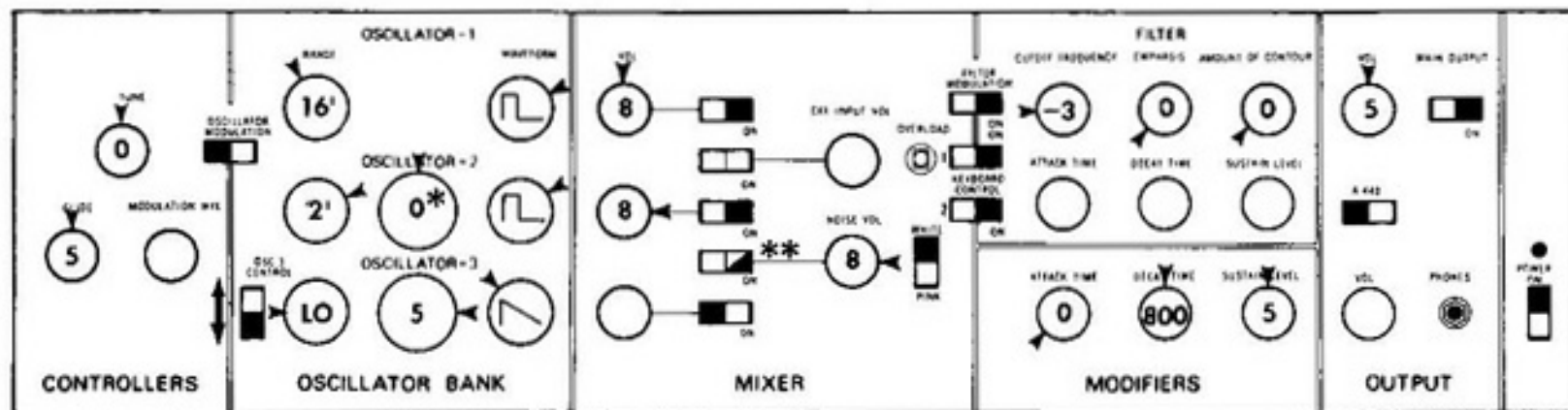

MINIMOOG

The T.L.R. sound

- * Oscillators in unison; octaves altered.
- ** Alternate white noise with pitched sound.

RHYTHMIC WAH-WAH EFFECTS

To create rhythmic wah-wah effects, set up the filter on the synthesizer with low CUTOFF FREQUENCY and high EMPHASIS as shown:

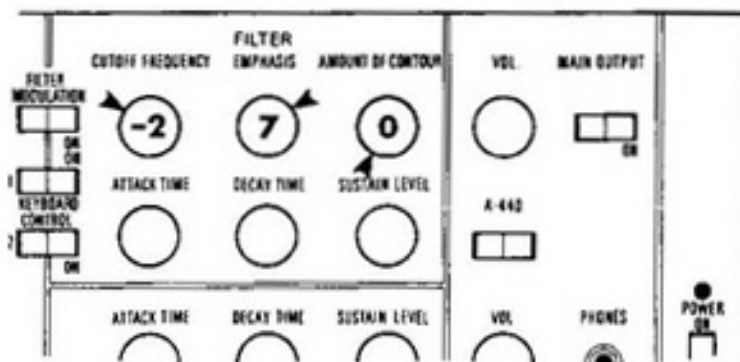

MINIMOOG

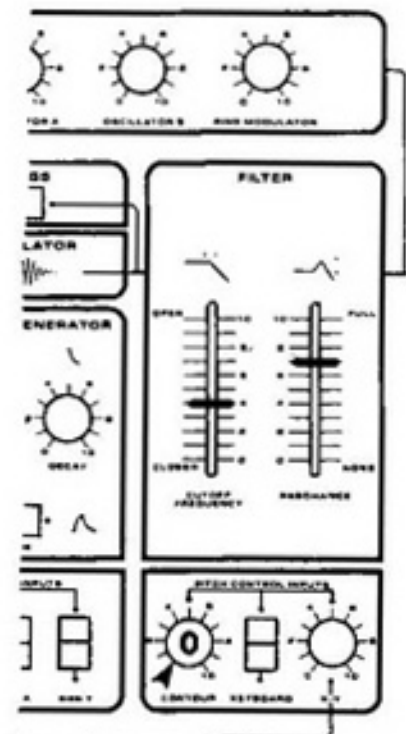

SONIC SIX

Connect the black plug on the 1130 to the FILTER jack (and two-prong plug if required). One performer can create rhythmic wah-wah patterns by playing the 1130 while another plays the keyboard.

1150 RIBBON CONTROLLER



The 1150 Ribbon Controller is a fretless fingerboard that produces a continuously variable control voltage. The voltage is determined by the point depressed on the surface of a taut metallic ribbon. A slide potentiometer provides a second continuously variable control voltage. Triggers (both "S" and "V") are produced by touching etched traces on the fingerboard.

The voltage is determined by the point depressed on the surface of a taut metallic ribbon. A slide potentiometer provides a second continuously variable control voltage. Triggers (both "S" and "V") are produced by touching etched traces on the fingerboard.

1150 Ribbon Controller

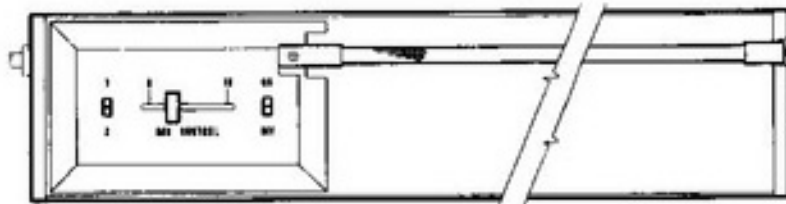

The 1150 is activated by the ON-OFF switch to the left of the ribbon element. When switched ON, the 1150 Ribbon Controller provides two independent, continuously variable control voltages available at the black and red phone plugs. S-Triggers are available at the two-prong plug; V-Triggers are available at the six-prong plug. The control voltage at the *red* phone plug may be

varied continuously according to the point at which the *ribbon* is depressed; the voltage corresponding to the last point depressed is held when the ribbon is released. The 1-2 switch selects the span of voltage the ribbon covers — position 1 selects a *wide* voltage span equivalent to ten or more octaves of pitch control. Position 2 is the *narrow* span, in which the spatial relationship of a musical interval played on the ribbon approximates that of the same interval played on the keyboard. Note that the ribbon on the 1150 is a *linear* device, like a keyboard — a musical interval retains the same spatial relationship on any portion of the ribbon. This prevents cramped fingering of upper notes as encountered on, say, a violin fingerboard.

The voltage at the *black* phone plug is controlled by the AUXILIARY CONTROL slider, which is calibrated from zero (no voltage) to 10 (maximum voltage, determined by the supply voltage available at the ACCESSORY socket on model of synthesizer in use.)

Triggers (both "S" and "V") are generated when the player's finger bridges the etched metal traces at *any* point along the fingerboard — the particular position touched on the traces has *no effect* on the control voltage produced by touching the ribbon. The S-Trigger is made available at the two-prong plug; the V-Trigger is available at the six-prong plug and appropriate models of MoogTM synthesizers are wired to receive this trigger through the ACCESSORY socket.

Directions for Use

Basic instructions for use are printed on the bottom of the Accessory. To use the 1150 Ribbon Controller:

CONNECT:

1. Six-prong plug to ACCESSORY socket on the synthesizer.
2. Red phone plug to OSCILLATOR external control input.
3. Black phone plug to FILTER external control input.
4. Two-prong plug to external S-Trig socket on appropriate models.

THEN:

1. Set up the synthesizer to produce the desired sound and "test" by striking the keyboard.
2. Switch the 1150 Ribbon Controller ON. Trigger the synthesizer by touching the metal traces at any point. Vary pitch of the oscillator(s) used by sliding finger on ribbon. Vary the cutoff frequency of the filter by moving the AUXILIARY CONTROL slider.

Maintenance

Use alcohol or cleaning fluid with a soft cloth to clean the contact surfaces of the ribbon, the resistive element beneath, and the area between the etched traces. Don't abuse the 1150; knicks and dents in the ribbon will result in uneven control response.

Applications

STEPLESS-PITCH INSTRUMENTS

The 1150 Ribbon Controller is ideal for controlling sounds similar to stepless-pitch instruments such as the Hawaiian Guitar, Theremin, and "musical saw". For this class of instrumental sounds, connect the 1150 to the synthesizer as indicated by the Directions for Use and set the 1-2 switch to the narrow (2) position. Set up an appropriate sound on the synthesizer.

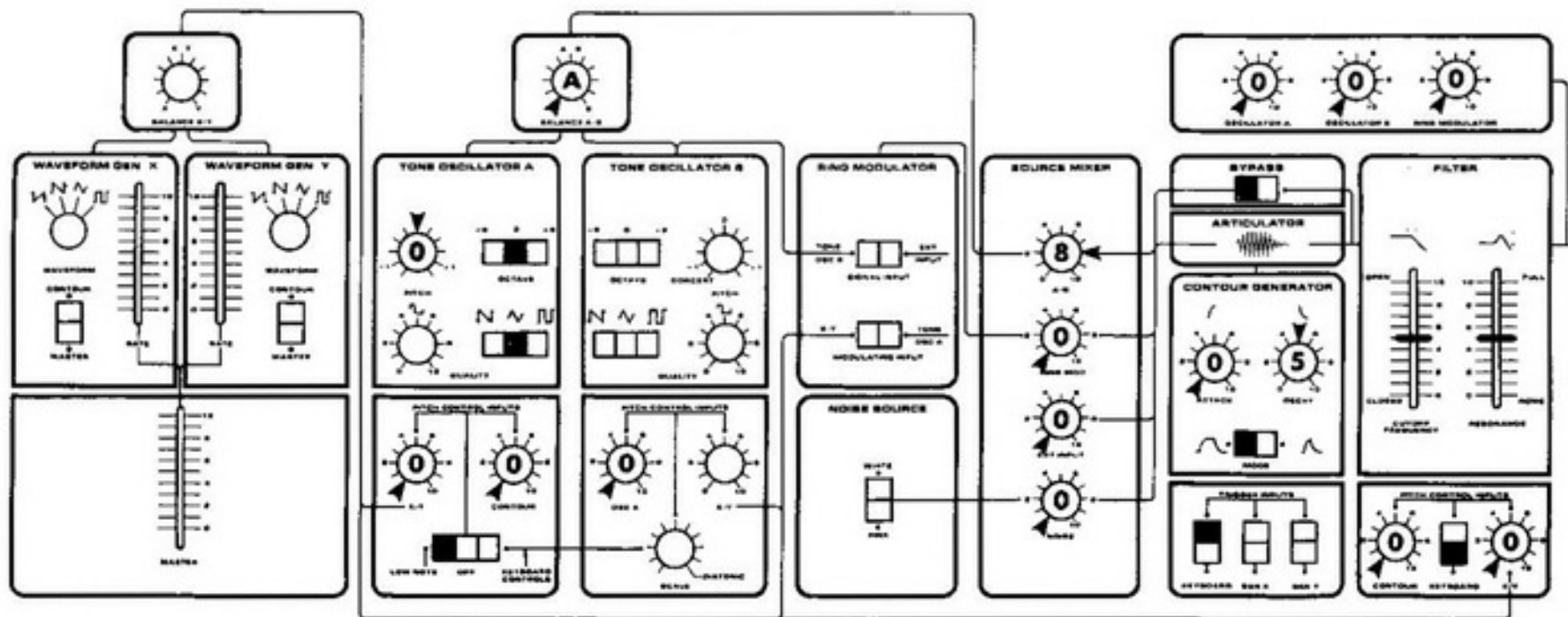

SONIC SIX

SOUND: HAWAIIAN GUITAR

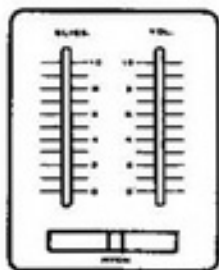

Trigger by touching the metal trace. With a little practice, melodies may be played accurately on the ribbon. Experiment with ATTACK and DECAY controls to create different effects.

tone/Loudness Control

The 1150 may be used as a convenient means of altering the filter cutoff frequency or loudness during performance. In this application, place the 1150 Ribbon Controller into the wide (1) voltage span position, and plug the *red* phone plug into the FILTER or LOUDNESS external control input. Tone color or loudness may be controlled by touching different points on the ribbon.

Rhythm Instrument Mode

The 1150 Ribbon Controller may be played rhythmically by drumming the hands across both the metal trace and the ribbon up and down the fingerboard; this is most effective when the oscillator drones at the same pitch. Plug the *red* phone plug into the FILTER external control input (do not use the BLACK phone plug) and set up the filter controls as shown:

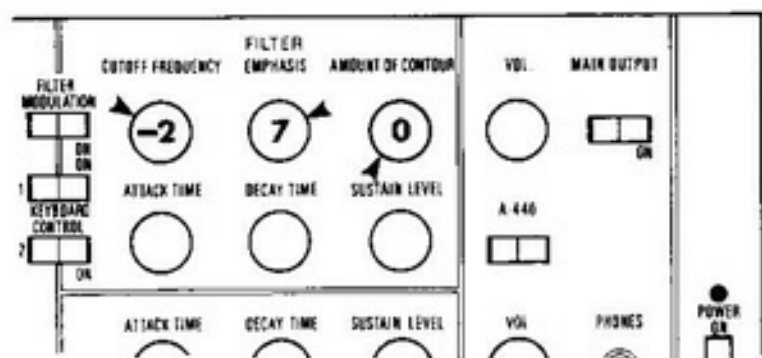

Play up and down the fingerboard as though it were the head of a drum. Be sure to touch both the ribbon and the traces simultaneously.

USE WITH KEYBOARD

The keyboard may be used with the 1150 Ribbon Controller for special effects. Connect the 1150 normally. Play repeating

figures  on the keyboard and create

long glissando effects by sliding on the ribbon.

1125 SAMPLE AND HOLD

The 1125 Sample and Hold Accessory is capable of generating a series



of stepped control voltage changes and synchronous triggers. A control voltage change and trigger may be initiated by playing the SAMPLE button, or a continuous string of voltage changes may be produced automatically, creating repeating, metronomic patterns of sound when used to control the synthesizer. The string of control voltage changes may be repetitive, random, or a mixture of the two.

How an 1125 Sample and Hold Works and its Features

For purposes of understanding how a Sample and Hold circuit works, it is useful to draw some parallels to a *camera*. A camera "samples" (*photographs*) movement and "holds" a fixed image (the *print*). A Sample and Hold circuit "photographs" (*samples*) a moving voltage and "prints" (*holds*) a fixed *voltage level*. When a sample of a moving voltage is taken, the voltage sensed at that instant is held until the *next* sample is taken. The following figure illustrates:

Take a sample NOW.

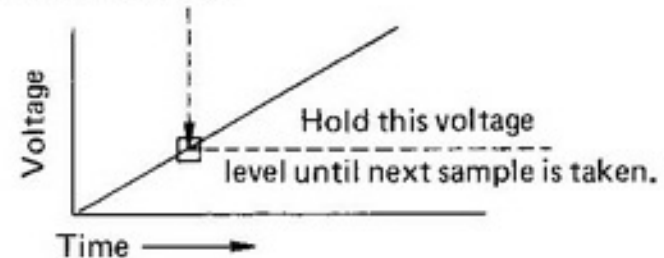

For instance, if a slowly rising voltage is sampled repeatedly at a given rate, the series of held voltage steps will comprise a staircase pattern as illustrated below:

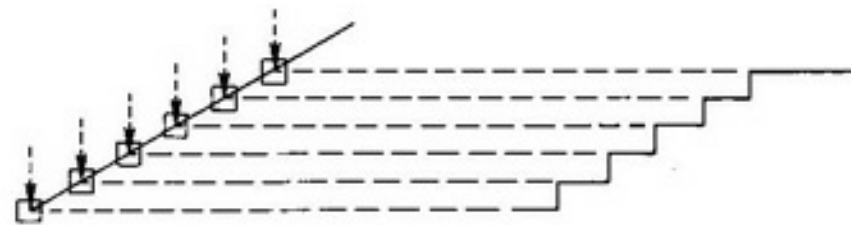

If the rising voltage repeats (like a *sawtooth* waveform), a *repeating* staircase pattern will

result.  If these staircase voltage steps are applied to the OSCILLATOR external control input on the synthesizer an ascending pattern of discrete pitches will result. The rate (frequency) of the sawtooth waveform that

is sampled and the rate at which samples are taken will determine the resulting pattern. A variety of patterns may be generated, including *descending* ones as illustrated:

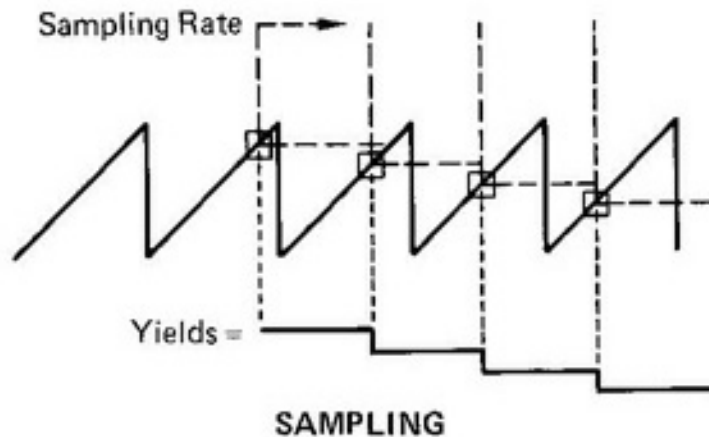

If *noise* is sampled a *random* pattern of voltage steps will be generated.

Random Pattern
from sampling
noise.

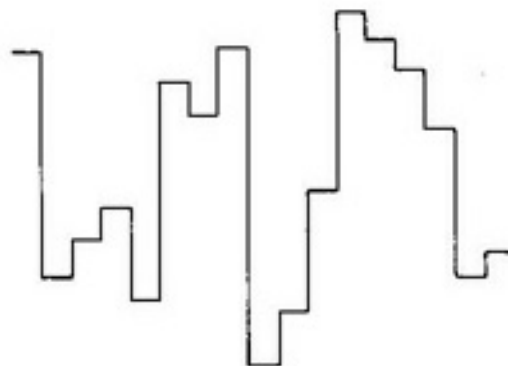

The 1125 Sample and Hold Accessory circuitry *includes* two low frequency oscillators and a noise source used to generate these repeating or random voltage steps.

The "clock" oscillator sets the rate at which samples are taken and generates synchronous triggers at a rate determined by the RATE control. The "sawtooth" oscillator creates slow sawtooth  waveforms that are sampled. The sawtooth repetition rate (frequency) may be changed independently with the PATTERN control, or *simultaneously* with the clock oscillator rate using the RATE control. The *simultaneous* mode of changing the frequency of both oscillators is a unique feature of the 1125 Sample and Hold Accessory that allows one to change the *rate* of a sample and hold pattern without disturbing the pattern being generated. Or, conversely, a variety of patterns may be generated using the PATTERN control without affecting the sampling rate.

Another unique feature is the GLIDE control, which may be used to smooth the control voltages produced by the 1125. This makes it possible to produce smooth, slow-moving control voltages to add "animation" to instrumental simulations.

The control voltage available at the red plug is switched on by the OUTPUT-1 switch on the 1125; the black plug, from OUTPUT-2. OUTPUT-2 (black phone plug) is scaled to always provide *one-half* the control voltage level of OUTPUT-1 for versatility in controlling two synthesizer functions simultaneously.

The following is a brief description of 1125 controls. An Instructional Sequence follows that will demonstrate their use.

Description of Controls:

RATE:	Controls the sample rate (clock oscillator frequency) from 0,5 Hz to 30 Hz. Also varies the sawtooth oscillator rate so that the ratio between clock and sawtooth oscillators remains constant.	OUTPUT-2:	On-off switch for control voltage routed to black phone plug. OUTPUT-2 (black phone plug) provides one-half the voltage level of OUTPUT-1 (red phone plug).
PATTERN:	Controls the frequency of the sawtooth oscillator without affecting sample rate.	TRIGGER:	On-off switch to route S-Triggers to two-prong and V-Triggers to six-prong plugs. May be operated independent of OUTPUT switches.
SAWTOOTH-RANDOM:	Varies the mix of the signal that is sampled from pure sawtooth to pure random (noise source).	RATE SPAN:	Selects to place RATE control in wide or narrow span. Wide span is one sample per two seconds to thirty samples per second. Narrow span is one sample every 1,4 seconds to sixteen samples per second.
SCALE:	Output level control that attenuates the control voltage available at both red and black phone plugs.	SCALE SPAN:	Selects to place SCALE control in wide or narrow operating span. In the narrow position, the control voltage pattern using the sawtooth is above 0 volts. In the wide position the control voltage is four times larger and centered about 0 volts.
GLIDE:	Provides a variable amount of smoothing of the output signal.	GATE WIDTH:	Provides selection of short or long trigger, analogous to how long a key on the synthesizer would be held down. The short trigger is 10 msec regardless of clock rate. The long trigger occupies one half the total clock period.
SAMPLE:	Provides a new sample and trigger when depressed.		
START:	Engages clock oscillator to provide metronomic, repetitive sampling.		
STOP:	Disengages clock oscillator.		
OUTPUT-1:	On-off switch for control voltage routed to red phone plug.		

Directions for Use

Follow the instructions printed on the underneath side of the 1125 Sample and Hold Accessory:

Connect:

1. 8-prong plug to cable coming from Accessory if not presently connected.
2. 6-prong plug to ACCESSORY socket on synthesizer.
3. Red phone plug to OSCILLATOR control input.
4. Black phone plug to FILTER control input.
5. 2-prong plug to S-TRIG input (on appropriate models).

Instructional Sequence

The following instructional sequence illustrates basic 1125 features, using typical control panel setups on the Moog Sonic Six and Minimoog.

- A. Set up a typical control panel setup on the synthesizer (as illustrated on pages 27 and 28).
- B. Depress Middle C on the keyboard to test the synthesizer setup and set the initial pitch level of the oscillators to be controlled.

MINIMOOG PREPARATORY PATTERN

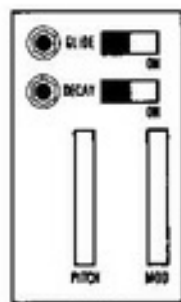
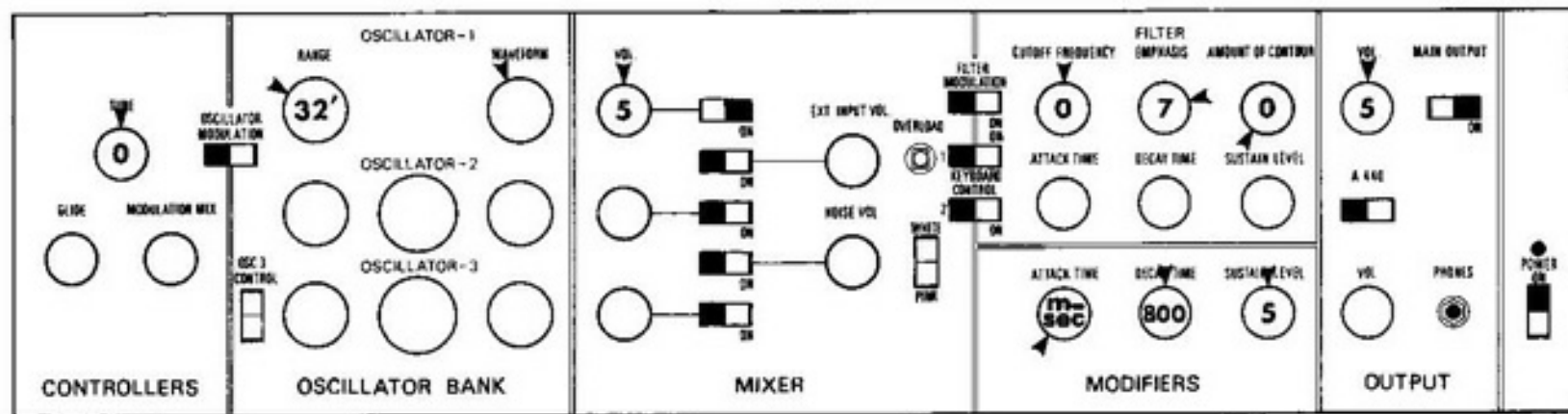

SONIC SIX PREPARATORY PATTERN

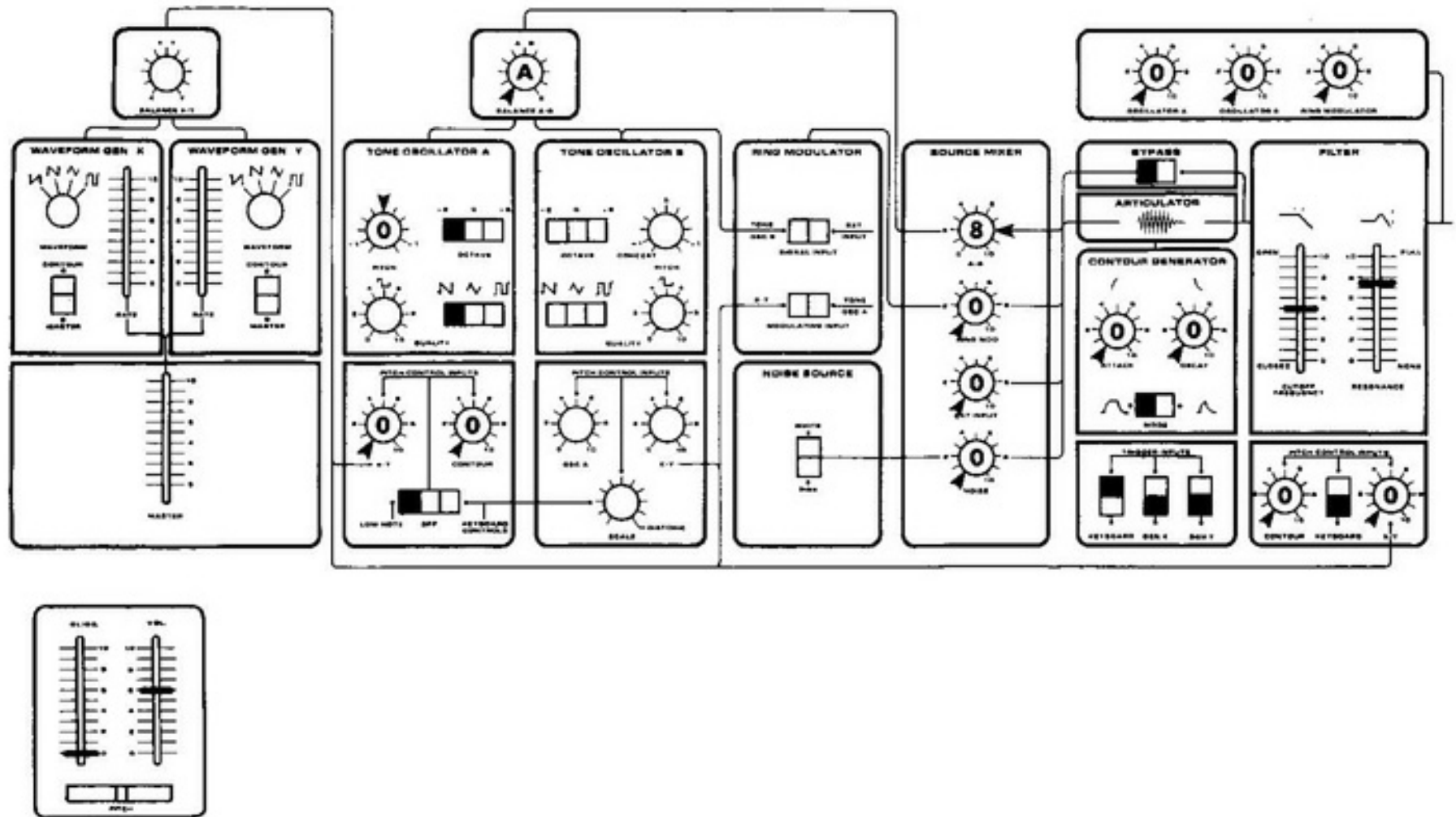

SAMPLE AND HOLD PREPARATORY PATTERN

C. Set the 1125 Sample and Hold controls into the *Preparatory Pattern* shown at right.

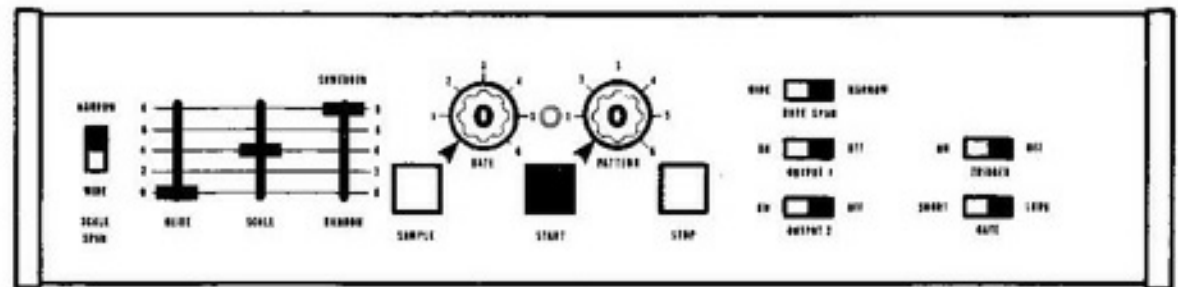

D. Perform the following:

1. Push START button. The blinking light indicates the sample rate.
2. Click TRIGGER switch *ON*. The synthesizer is now being triggered by the Sample and Hold.
3. Click GATE switch to *SHORT*. Note effect. Return to *LONG*.
4. Turn RATE control through all settings and return to 0.
5. Click RATE SPAN to *WIDE*. Again, turn RATE control through all settings. The RATE SPAN switch selects to place the RATE control into a narrow or wide operating span.
6. Turn RATE control to 2. Return RATE SPAN to *NARROW*.
7. Click OUTPUT-1 switch *ON*. This routes a control

voltage through the *red* phone plug. Since this phone plug is placed in the OSCILLATOR control input, the Sample and Hold will control the *oscillator(s)* to create a pattern in *pitch*.

8. Click OUTPUT-1 *OFF*.

9. Click OUTPUT-2 *ON*. This routes a control voltage to the *black* phone plug. Since the black phone plug is placed in the FILTER control input on the synthesizer, the cutoff frequency of the filter will be controlled, creating a pattern in *tone color*.

10. Alternately click OUTPUT-1 and OUTPUT-2 *ON*. Leave both *ON*.

11. Turn PATTERN control slowly clockwise. This alters the pattern without disturbing its rate.

12. Return PATTERN control to 0.

13. Move SCALE slider slowly to 0. The SCALE slider controls the *amount* of the control voltage that is routed to the synthesizer; when SCALE is at 0 no control effects are possible, but the synthesizer may still be triggered by the Sample and Hold.

14. Move SCALE slider slowly to 8.

15. Move SAWTOOTH/RANDOM slider to RANDOM. The RANDOM position provides random patterns; the SAWTOOTH position provides regular patterns. Intermediate positions provide mixtures of the two.

16. Turn PATTERN control throughout its positions (no change). The PATTERN control has no effect on the RANDOM position of the SAWTOOTH/RANDOM slider.

17. Return PATTERN control to 0.

18. Click SCALE SPAN switch to WIDE. The SCALE SPAN switch selects to allow the SCALE slider to operate over a narrow or wide operating span.

19. Move GLIDE slider slowly upward. Use of GLIDE smooths the output pattern.

20. Return GLIDE to 0.

21. Depress STOP button.

22. Depress SAMPLE button repeatedly for individual samples.

Applications

PITCH-FILTER PATTERNS

Connect the 1125 normally. The Instructional Sequence gives some indication of typical use of the 1125. It is useful to remember that the control voltages from the keyboard and other synthesizer control sources *add* to that of the 1125. The keyboard may be played while OUTPUT-2 is used to create filter changes only. When you use the 1125 to control the oscillators, the OUTPUT-1 switch must be cut *off* when you wish to return to the original pitch level for normal keyboard use.

CONTROLLING CHORDS

Because the 1125 is *not* built into the synthesizer it does not "rob" the synthesizer of the use of its oscillators to create the "clock" and "sawtooth" oscillators. It is possible to use *all* of the tone and modulating oscillators on the synthesizer, since the 1125 provides its *own* oscillator circuitry independent of the synthesizer. Set up complete chords on the synthesizer and control them with the 1125.

Controlling parallel chords with the 1125 Sample and Hold.
 (Fine tune OSCILLATOR-2 and OSCILLATOR-3 to produce a chord.)

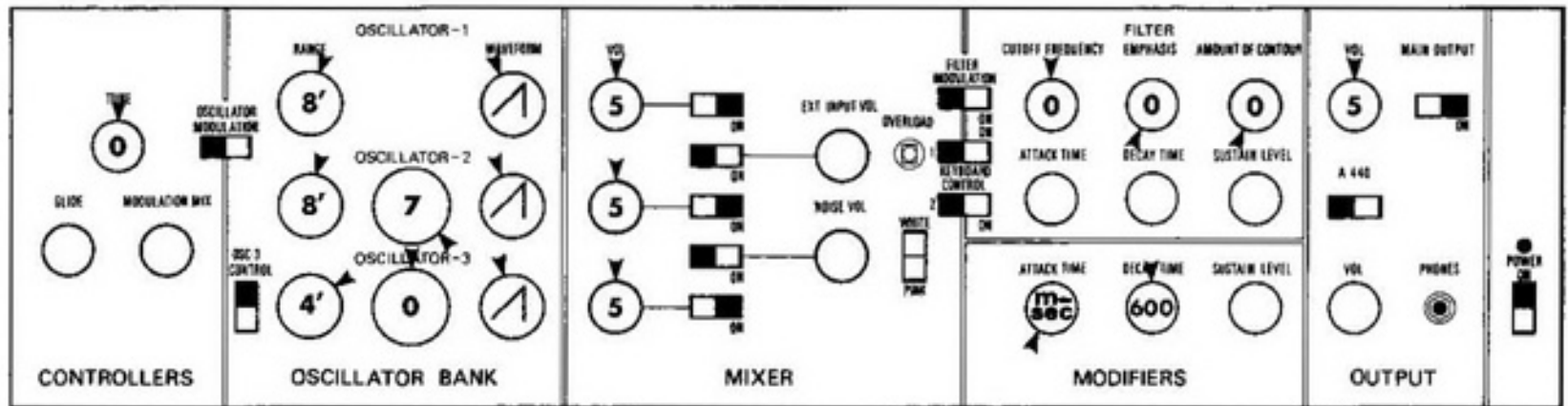

MINIMOOG

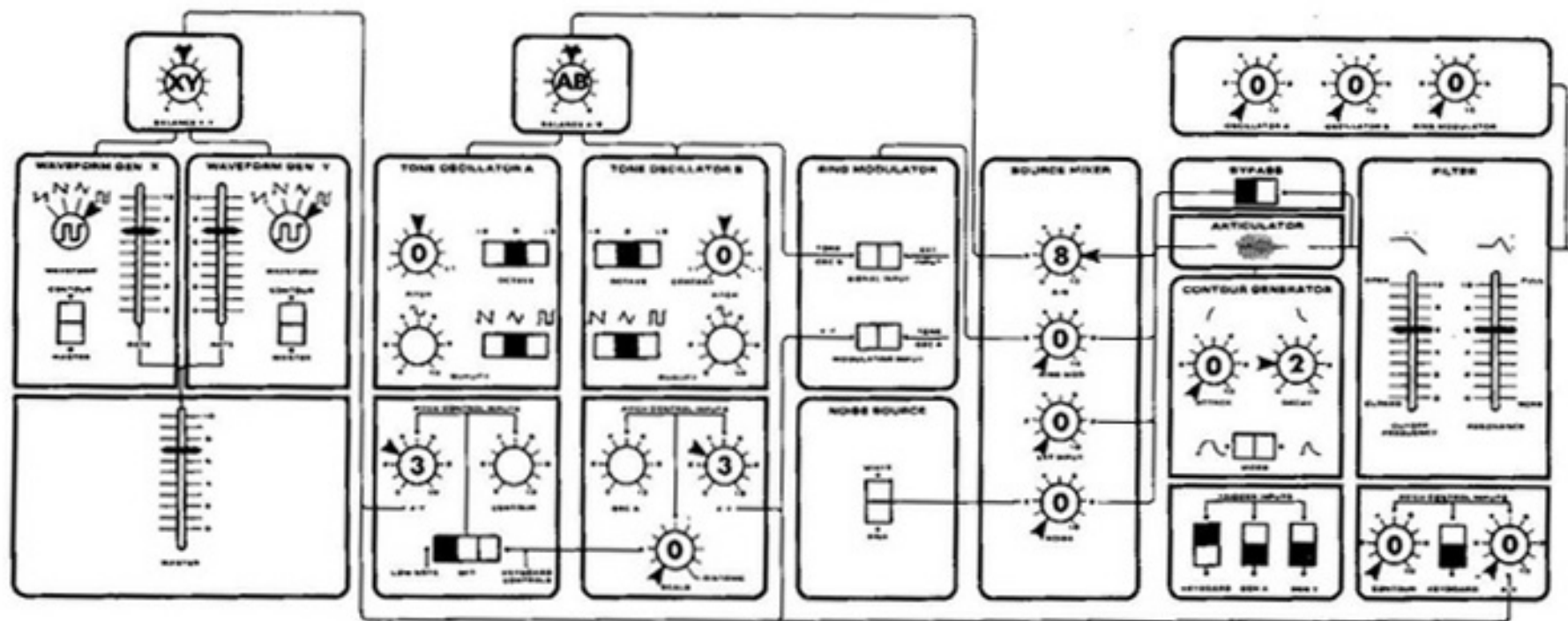

SONIC SIX

MODULATION EFFECTS

All of the capabilities of the synthesizer are retained when the 1125 is used, including use of modulation. Set up the following and control with the 1125.

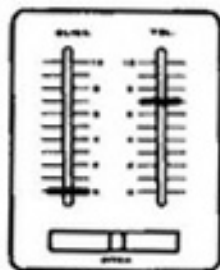

SLOW RANDOM MODULATION

Use the unique GLIDE feature to create a smooth, slow-moving random voltage that may be used to subtly add randomness to pitch or tone color. Set up the 1125 as follows:

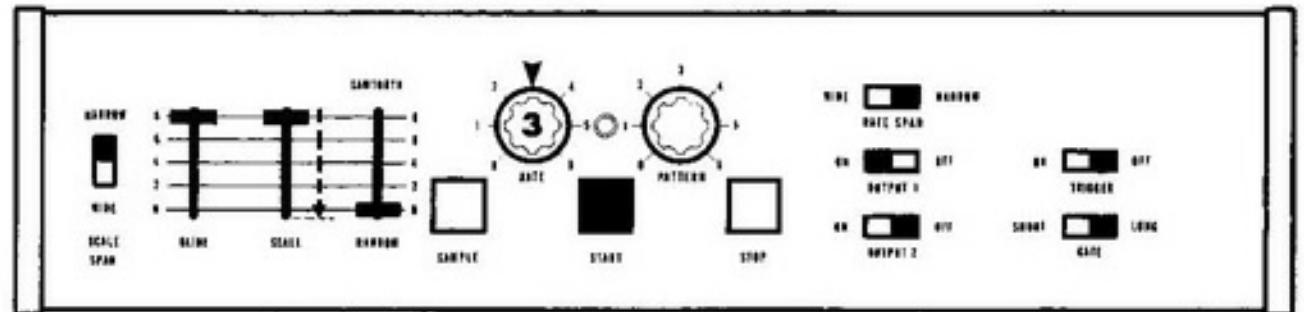

1125 SAMPLE AND HOLD

and insert the *red* phone plug into the FILTER jack. Play the keyboard, holding a note. Lower the CUTOFF FREQUENCY control on the synthesizer until the slow random effect is noticeable. Vary the SCALE control on the 1125 to control *amount* of effect.



exclusive distributor: NORLIN MUSIC, INC. 7373 NORTH CICERO AVENUE, LINCOLNWOOD, ILLINOIS 60646