

SERVICE MANUAL for

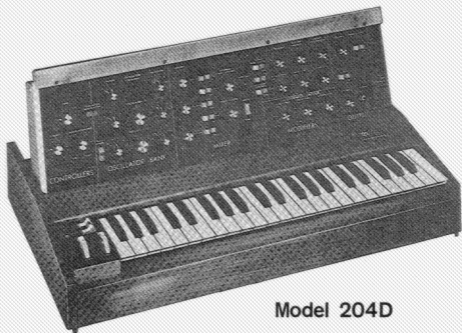

Model 204D

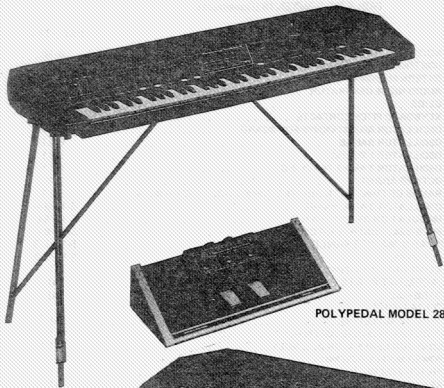

TABLE OF CONTENTS

SECTION		PAGE NO.
	SPECIFICATIONS	vi
1	INTRODUCTION	1-1/2-1
	1.1 GENERAL	1-1/2-1
	1.2 PRECAUTIONARY MEASURES	1-1/2-1
2	CIRCUIT DESCRIPTION	1-1/2-1
	2.1 GENERAL	1-1/2-1
	2.2 GENERAL CIRCUIT DESCRIPTION	1-1/2-1
	2.3 "D" OSCILLATOR PRINTED CIRCUIT BOARD	2-3
	2.4 MODULATION MIX AMPLIFIER	2-5
	2.5 NOISE GENERATOR	2-5
	2.6 HEADPHONE AMPLIFIER	2-6
	2.7 POWER SUPPLY	2-6
	2.8 VOLTAGE CONTROLLED FILTER	2-7
	2.9 VOLTAGE CONTROLLED AMPLIFIER	2-7
	2.10 CONTOUR GENERATORS	2-7
	2.11 A-440 REFERENCE OSCILLATOR	2-9
	2.12 EXTERNAL PREAMPLIFIER AND OVERLOAD LAMP DRIVER	2-9
	2.13 OLD MINIMOOG OSCILLATOR BOARD	2-9
	2.14 -5 VOLT REFERENCE SUPPLY	2-9
	2.15 OCTAVE SWITCHES	2-9
	2.16 OSCILLATOR ONE	2-10
	2.17 OSCILLATOR TWO	2-10
	2.18 OSCILLATOR THREE	2-10
	2.19 KEYBOARD CIRCUIT	2-10
3	TROUBLESHOOTING	3-1
	3.1 OVERALL QUICK REFERENCE TROUBLESHOOTING	3-1
	3.2 OSCILLATOR PRINTED CIRCUIT BOARD NO. 1 TROUBLESHOOTING (SERIAL NUMBERS 10175 AND ABOVE)	3-3
4	DISASSEMBLY PROCEDURES	4-1/5-0
	4.1 DISASSEMBLY	4-1/5-0
5	ADJUSTMENT AND TUNING	4-1/5-0
	5.1 PRINTED CIRCUIT BOARD REPLACEMENT ADJUSTMENTS	4-1/5-0
	5.2 VOLTAGE ADJUSTMENTS	5-1
	5.3 TUNING OSCILLATORS (SERIAL NUMBER 10175 AND ABOVE)	5-3
	5.4 TUNING THE OSCILLATOR (SERIAL NUMBERS BELOW 10175)	5-4
	5.5 DETAILED ADJUSTMENT PROCEDURES	5-4
	5.6 POWER SUPPLY ADJUSTMENT	5-8
	5.7 A-440 ADJUSTMENT	5-8
	5.8 SIGNAL FLOW	5-8
	5.9 MAIN OUTPUT	5-8
	5.10 PHONE OUTPUT	5-8
	5.11 LOW MAIN OUTPUT	5-9
	5.12 EMPHASIS CALIBRATION	5-9
	5.13 FILTER CUTOFF ADJUSTMENT	5-9
	5.14 FILTER SCALE	5-9
	5.15 KEYBOARD 1/3	5-9
	5.16 EXTERNAL FILTER CONTROL	5-9
	5.17 AMOUNT OF CONTOUR	5-9
	5.18 FILTER CONTROL	5-9
	5.19 AMOUNT OF MODULATION	5-9
	5.20 FILTER CONTOUR	5-9
	5.21 DOUBLE TRIGGERING	5-10
	5.22 LOUDNESS CONTOUR	5-10
	5.23 EXTERNAL LOUDNESS CONTROL UNIT	5-10

TABLE OF CONTENTS (Continued)

SECTION		PAGE NO.
	5.24 NOISE	5-10
	5.25 CONTOUR GENERATOR BALANCE	5-10
	5.26 EXTERNAL SIGNAL INPUT	5-10
	5.27 AUDIO NOISE GENERATOR	5-10
	5.28 GLIDE	5-10
	5.29 KEYBOARD PITCH CONTACTS	5-11
	5.30 OSCILLATOR ADJUSTMENTS FOR BOARD	5-11
	5.31 OSCILLATOR RANGE	5-11
	5.32 OSCILLATOR 1 TUNING	5-11
	5.33 OSCILLATOR 2 AND 3 TRACKING	5-11
	5.34 OCTAVE ADJUST	5-11
	5.35 RANGE OF TUNE, PITCH AND FREQUENCY ADJUST CONTROLS	5-11
	5.36 OSCILLATOR 3 WIDE RANGE	5-12/6-0
	5.37 MODULATION OF OSCILLATOR	5-12/6-0
	5.38 EXTERNAL CONTROL OF OSCILLATOR	5-12/6-0
6	KEYBOARD MAINTENANCE	5-12/6-0
	6.1 CLEANING	5-12/6-0
	6.2 KEYBOARD ADJUSTING PROCEDURE	6-1
7	REPLACEMENT PARTS LIST	7-0
	7.1 ORDERING	7-0
8	MODIFICATIONS	8-1
	8.1 SERVICE BULLETINS	8-1
	8.2 OSCILLATOR BOARD ASSEMBLY	8-1
	8.3 CONTOUR GENERATOR ASSEMBLY	8-1
	8.4 POWER SUPPLY ASSEMBLY	8-1
	8.5 FILTER ASSEMBLY	8-1
	8.6 KEYBOARD CIRCUIT PRINTED CIRCUIT BOARD NO. 2	8-1
	8.7 MINIMOOG OSCILLATOR TUNING	8-2
	8.8 OSCILLATOR BOARD NO. 1, POWER SUPPLY CONNECTION AND OCTAVE BUFFER	8-2
9	SCHEMATIC DIAGRAMS AND PRINTED CIRCUIT BOARDS	8-8/9-0
LIST OF ILLUSTRATIONS		
2-1	Simplified Block Diagram	2-11
2-2	Subassembly Location Diagram	2-12
2-3	Printed Circuit Board Socket Location	2-12
2-4	Left Hand Controller	3-1
5-1	Power Supply Adjustment Location Diagram	5-2
5-2	Rear Panel Tuning Control Location Diagram (Serial Numbers 10175 And Above)	5-2
5-3	Filter Adjustment Location Diagram	5-2
5-4	Front Panel Control Settings (Serial Numbers 10175 And Below)	5-2
5-5	Front And Rear Panel Location (Serial Numbers 10175 And Below)	5-2
6-1	Use Of Keyboard Adjusting Tool	6-1
7-1	Front Panel Control Diagram	7-1
8-1	Printed Circuit Board 2 Modification	8-3
8-2	Rear Panel Modification Diagram	8-4
8-3	Front Panel Controls Diagram	8-5
8-4	Rear Panel Adjustment Location Diagram	8-5
8-5	Connector Modification Diagram	8-7
8-6	Octave Buffer Schematic	8-8/9-0



POLYMOOG
SYNTHESIZER
MODEL 203A

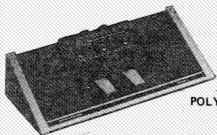

POLYPEDAL MODEL 285A

POLYMOOG
KEYBOARD
MODEL 280A



POLYPEDAL MODEL 285A

**MULTIMOOG
SYNTHESIZER
MODEL 326A**



**MICROMOOG
SYNTHESIZER
MODEL 2090**

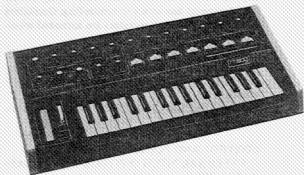

**12 STAGE PHASER
MODEL 307A**

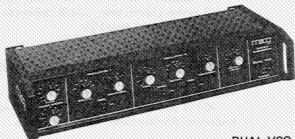
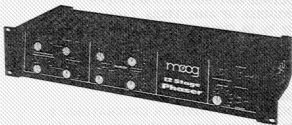

*DUAL VCO CAN BE SPECIAL ORDERED
THROUGH MOOG CUSTOM ENGINEERING
OR YOUR INTERNATIONAL DISTRIBUTOR*

DUAL VCO

Specifications

SOUND SOURCES

NO. OF SOUND SOURCES: 5 (3 Oscillators, 1 Noise Source, 1 External Input/Microphone Pre-amp).

OSCILLATOR FREQUENCY: 0.1 to 20kHz (cycles/second) in six overlapping ranges.

SHORT TERM OSCILLATOR STABILITY: Better than 0.25%.

OSCILLATOR WAVEFORM OUTPUTS: Triangular, Sawtooth, Triangular-Sawtooth Mix (Oscillators 1 and 2 only), Reverse Sawtooth (Oscillator 2 only), 3 widths of Rectangular.

NOISE SOURCE OUTPUTS: White or Pink random waveforms.

PREAMPLIFIER INPUT: 10 millivolts minimum; 2 volts maximum.

PREAMP INPUT IMPEDANCE: 100K ohms or greater.

FILTER

FILTER CHARACTERISTIC: Wide-range low-pass filter with variable-height resonant peak at cut-off frequency, and 24dB/octave cutoff slope.

RANGE OF CUTOFF FREQUENCY: Continuously variable from 40Hz to 20kHz (9 octaves).

VOLTAGE CONTROLLED AMPLIFIERS

NUMBER OF AMPLIFIERS: 2 (one controlled only by its Contour Generator; the other controlled by optional external controller).

DYNAMIC RANGE OF EACH AMPLIFIER: 80dB.

CONTOUR GENERATORS

NUMBER OF CONTOUR GENERATORS: 2 (one controlling filter through an attenuator; the other controlling the first voltage Controlled Amplifier).

RANGE OF ATTACK TIME: 10 milliseconds to 10 seconds.

RANGE OF DECAY TIME: 10 milliseconds to 10 seconds.

RANGE OF SUSTAIN LEVEL: 0 to 100% of contour peak.

WIDTH OF SWEEP OF FILTER BY ITS CONTOUR GENERATOR: Continuously variable from 0 to 4 octaves.

AUDIO SIGNAL OUTPUTS

HIGH LEVEL OUTPUT: 0.5 volts typical, with 3K ohms nominal output impedance.

LOW LEVEL OUTPUT: 15 millivolts typical, with 1K ohm output impedance.

HEADPHONE OUTPUT: 0.3 volts maximum, into standard 8-ohm stereo headphones.

CONTROLLERS

KEYBOARD FUNCTION: Permanently connected to (a) control Oscillators 1 and 2, and (b) trigger Contour Generators. Keyboard may be switched to control Oscillator 3 and Filter.

DESCRIPTION OF KEYBOARD: Standard 44 key (3-1/2-octave) organ keyboard. Only lowest key depressed has effect in controlling Oscillators and Filter. Contour Generators are activated whenever a single key is depressed.

RATE OF KEYBOARD GLIDE: Continuously variable from 1 millisecond to 1 second/octave.

PITCH BENDING RANGE: 5 semitones minimum.

MODULATION INJECTION RANGE: 0 to 1-1/4 octaves.

CONTROL AND POWER CONNECTIONS

EXTERNAL PITCH CONTROL INPUT CHARACTERISTIC: 1 volt change produces 1 octave frequency change, ± 2 percent.

EXTERNAL FILTER CONTROL INPUT: 1 volt change produces 1 octave change in cutoff frequency, ± 5 percent.

EXTERNAL AMPLIFIER CONTROL INPUT: Linear control voltage/gain relationship. Gain range spanned by 0-4 volts.

EXTERNAL TRIGGER INPUT: Switch-closing activates both Contour Generators.

AUXILIARY DC POWER SOCKET: +10 volts and -10 volts at 50 milliamperes.

DIMENSIONS AND WEIGHT

OVERALL SIZE (with Front Panel down): 28-5/8 inches (72cm) wide, 17-1/8 inches (41cm) deep, 5-3/4 inches (14cm) high.

NET WEIGHT: 28 pounds (12.7kg).

SHIPPING WEIGHT: 45 pounds (20.5kg).

POWER REQUIREMENTS

100-135 and 200-270 volts, 50-60Hz, 40 watts maximum. Specifications subject to change.

major differences in the two boards is that common summing is used on the new board while individual summing is used on the old board.

All three oscillators have individual octave switching signals applied to three adjustable potentiometers providing precision octave switching of the individual oscillators.

2.2.2 MODULATION MIX AMPLIFIER

A modulation mix amplifier selects the output of oscillator 3 or noise, or both, sums and routes them to the amount control in the left hand controller.

2.2.3 NOISE GENERATOR

The Minimoog contains a noise generator using a transistor generating white noise in the range of -60dB which is amplified to produce white, pink or red noise, selected by the noise selector switch. White or pink noise is used for audio and pink or red for modulation.

2.2.4 HEAD PHONES

An amplifier is provided to supply sufficient current to drive standard stereo headphones.

2.2.5 POWER SUPPLY

A dual output power supply with the rectifier on Board 3, the filter on Board 5 and the transformer on the chassis, provides ± 10 volt regulated power. The input is either 115 or 230 volt as selected through a switch on the top of the panel.

2.2.6 KEYBOARD CIRCUIT

The keyboard circuit consists of a temperature compensated current source, the actual keyboard and a track and hold amplifier. The keyboard voltage is routed to a track and hold amplifier where, with no keys depressed, the circuit is in a hold mode. With a key depressed, the pitch voltage occurs before the trigger and the trigger goes off before the pitch voltage is released.

2.2.7 A-440 REFERENCE OSCILLATOR

The A-440 reference oscillator is based on a standard Wein Bridge oscillator design. The bridge has a phase shift of zero degrees at approximately 440Hz, supplying a positive feedback and causing the circuit to oscillate. The frequency of the oscillation is set by a resistor. Three capacitors and a resistor limit the signal amplitude to a transistor collector resulting in a clean sine wave output.

2.2.8 EXTERNAL AMPLIFIER

The external preamplifier is fed to the EXTERNAL INPUT VOLUME control where the output is fed through a 200 gain amplifier and in turn routed to the EXTERNAL INPUT ON/OFF switch. This switch allows an external source to be summed with other signal sources.

2.2.9 OVERLOAD LAMP DRIVER

The output from the 200 gain amplifier is also fed to the overload lamp driver circuit. The amplitude envelope of the signal is detected and fed to a voltage divider. When the AC input voltage reaches approximately 1.2 volts, the OVERLOAD lamp illuminates and is held for a suitable period.

2.2.10 VOLTAGE CONTROLLED FILTER

"Audio" signals are summed and a differential signal current is generated and applied to a filter ladder. Cutoff frequency of the filter is controlled by the standing current through the ladder. The higher the standing current, the higher the cutoff frequency. A differential signal is created and fed to a gain amplifier which converts the differential input to a single ended output in turn fed to a transistor in the voltage control amplifier. The FILTER EMPHASIS control is also connected to the gain amplifier providing positive feedback at the cutoff frequency. As the amount of emphasis is increased, the Q increases and the filter starts a sine wave oscillation at the cutoff frequency.

The cutoff frequency control current originates in an exponential voltage to a current converter. Control voltages from the external input, keyboard

switches, modulation and the contour generator are summed and fed to the exponential convertor. A resistor sets the keyboard scale at one volt per octave and in turn the front panel filter CUTOFF FREQUENCY control is calibrated in a similar manner.

2.2.11 VOLTAGE CONTROLLED AMPLIFIER

The input signal from the voltage controlled filter is AC coupled to a differential transconductance multiplier. The gain of the transistor is current controlled; the greater the current, the higher the gain.

2.2.12 CONTOUR GENERATORS

Separate contour generators are provided for both filter and loudness contours. Each contour generator has its own controls consisting of ATTACK, DECAY and SUSTAIN. Contour generators are triggered by an internal voltage trigger from the keyboard and/or the rear panel S-TRIG jack. The amount of contour control adjusts the sweep of the voltage controlled lowpass filter.

2.3 "D" OSCILLATOR PRINTED CIRCUIT BOARD (Refer to Figures 9-1 and 9-2)

The new "D" oscillator printed circuit board is a plug-in replacement card for earlier oscillator boards. This board contains three precision voltage controlled oscillators with a variety of control inputs and a number of waveform outputs for each of the three oscillators.

The schematic diagram shows not only the oscillator board itself, but several of the associated control circuits and output selection circuits for circuit clarity. A variety of input control signals namely, PITCH WHEEL, TUNE, MOD WHEEL and OSCILLATOR (three oscillators) are summed via the "primary oscillator summer" amplifier IC1A. This common summing (as opposed to individual summing sections for these control inputs in the old Minimooq oscillator printed circuit board) guarantees that when the oscillators track the keyboard input, they also track these other common drive signals. The output of the primary oscillator summer, IC1A, is scaled at this point to provide 1.00 volt per octave by adjusting

oscillator scale adjust potentiometers R16, R55 and R91 of the three oscillator sections. These three scale potentiometers are adjusted so that the three oscillators on each board track the keyboard drive signal exactly. Final adjustments of these scale potentiometers must be made for an assembled unit, since the keyboard scale factor for different frames will vary slightly.

All three oscillators have individual octave switching signals applied to the octave adjust potentiometers R18, R57 and R92. These octave adjust inputs provide precision octave switching of the individual oscillators, and as the scale adjusts, must be adjusted to their final value in the assembled unit.

Oscillator 2 has an additional input labeled OSCILLATOR-2 FREQUENCY which provides for tuning \pm a musical fifth. Oscillator 3 has two additional inputs which are both driven by the OSCILLATOR-3 FREQUENCY CONTROL providing \pm a musical fifth control when the OSCILLATOR-3 CONTROL is on (namely, when the keyboard control voltage is applied to oscillator 3 by the switching FET Q2) or providing \pm 3 octaves of control when the OSCILLATOR-3 CONTROL is off. When this control is off, both feed resistors R96 and R97 are connected to the OSCILLATOR-3 FREQUENCY front panel potentiometer.

The various frequency control inputs for the three oscillators are summed together in amplifiers IC1B, IC3A and IC3B. Resistors R22, R62 and R100 provide for bias current temperature drift compensations. It should be noted at this point that all three oscillators are identical from this point on, except for the addition of a reverse sawtooth circuit associated with Q20 in oscillator 3. For this reason we will discuss the detailed operation of only oscillator 3.

The composite frequency control signal appearing at the output of IC3B is applied to the precision voltage divider comprised of R101 and R102 which divides the composite frequency control signal down to 21.0mV/octave. This divided down frequency control signal is applied to the base of the exponentiating transistor Q17 which is contained along with its companion transistor Q18 in a temperature stabilized package, IC15 (Fairchild 726). This

integrated circuit is maintained at a constant temperature of approximately 78.4°C by circuitry internal to the integrated circuit. The actual temperature of the chip is set by the resistor R105. Transistor Q18 is a V_{be} compensation transistor whose collector current is maintained constant by a combination of R108, R106 and IC16. The plus input of IC16 is maintained at ground. The output of IC16 sinks current through the emitter of Q18 such that the voltage appearing on pin 2 of IC16 is also ground. If we assume that there is no bias current flowing into the negative input of IC16 (valid since this integrated circuit is a FET input operational amplifier) then we see that 5.0 microamperes of current is flowing into the collector of transistor Q18, regardless of the current drawn through the emitter of transistor Q17. This circuit configuration provides a precision temperature compensated base emitter reference subtraction voltage for the exponentiating transistor Q17. The current flowing into the collector of Q17 is exponentially related to the voltage applied to the base on pin 1. This current is applied to the oscillator integrating capacitor C29 via the "high end comp" potentiometer R109. The reference side of the integrating capacitor C29 is tied to a 5.0VDC reference rail derived from the +10VDC rail via the resistor divider network R103 and R104, and the voltage follower IC14A whose output is bypassed to ground via C28. The FET Q14 shunts the integration capacitor C29 to +5 whenever the voltage appearing at the input of the comparator amplifier IC17 reaches ground. The voltage appearing on the lower side of the integrating capacitor C29 is a ramp headed toward 0.0VDC. The voltage appearing on the integrating capacitor plus the voltage drop across the "high end comp" potentiometer R109 is buffered by the voltage follower comprised of IC17 and emitter follower Q15, R114, R115 and R116. The buffered negative ramp appearing on the emitter of Q15 is applied to the comparator IC18B which switches the shunt FET Q14 on when the ramp voltage reaches zero via coupling diode CR5 and capacitor C31. When the shunt transistor Q14 turns on, the capacitor voltage is returned to +5VDC which in turn causes the shunt FET Q14 to turn off via the buffer amplifier IC17, the comparator IC18B and pull up resistor R110. Then the negative going ramp integration begins again. As the integration current supplied via R109 is increased, a residual voltage up and above the linear ramp signal appearing across

R109 shows up at the voltage follower IC17 and thereby at the voltage comparator IC18B. This residual voltage means that the actual ramp value appearing on the capacitor required to trigger the comparator IC18B is reduced at higher frequencies. It is possible to set R109 so that the effect of nonlinearities due to a finite reset time of the capacitor C29 are compensated for by this additional residual voltage. Resistor R112 and capacitor C34 provide for a small amount of positive regeneration (Schmitt trigger action) to insure clean switching during sawtooth reset. The sawtooth voltage appearing at the emitter of Q15 is applied to the bias network comprised of R114, R115 and R116. The values of this network are chosen so that the voltage appearing on the sawtooth output (pin 13B) is precisely +1.75VDC to -1.75VDC. Resistor R137 is a selected resistor whose value is chosen to achieve accurate symmetry in this output waveform. This symmetry is important to achieve an accurate 50 percent duty cycle of the rectangular waveform appearing on pin 15B.

While the sawtooth appearing on the emitter of Q15 goes precisely from +5VDC to 0.0VDC, a voltage equal to V_{be} above this is available at the base of Q15. This base voltage is also applied to the triangular wave converter transistor Q16. Triangular conversion circuit comprised of Q16, R118 and R120 acts as a precision inverter as the sawtooth waveform travels between 0VDC and +2.5VDC. From 2.5VDC to 5.0VDC transistor Q16 is in saturation with essentially zero collector to emitter voltage drop. In this condition the emitter of Q16 follows very closely the emitter of Q15 which, of course, is the sawtooth waveform. Since there is negligible collector-to-emitter voltage drop in this saturated condition, the collector of Q16 then follows accurately the sawtooth waveform between 2.5VDC and 5VDC. Therefore, during half of the cycle the triangular conversion circuit acts as a precision inverter and during the second half of the cycle it acts as a precision voltage follower, resulting in a precision triangular waveform output. This precision triangular waveform appearing at the collector of Q16 is then applied to the buffer with gain comprised of IC14B, R121 and R122 via the de-glitching RC network comprised of R119 and C35. This suppresses the fast transient which occurs in the triangular wave output which occurs during the sawtooth waveform

reset. The output of the follower IC14B is a triangular waveform which goes from +1.75VDC to -1.75VDC.

The sawtooth waveform appearing on the output pin 13B is applied to the rectangular wave shaping circuit comprised of IC18A, R117, R125 through R127, and R131 and R132. A control voltage which ranges between 0VDC and -2.5VDC is applied to the negative input of IC18A via the biased divider network R126 and R127. The sawtooth waveform is applied to the positive input of IC18A via R117. Resistor R125 provides a very small amount of positive regenerative feedback to give clean square wave switching. When the control voltage on pin 16B is 0.0VDC, a square wave output swinging between the negative rail and ground appears on the output of IC18A. This voltage is divided down by R131 and R132 to give a 0VDC to -3.5VDC triangular wave output. When the voltage applied to the control input on 16B is taken to -2.5VDC, a 15 percent duty cycle should appear on pin 1 of IC18A. All of this paragraph is relevant to oscillators 1 and 2. However, oscillator 3 has a sawtooth inverter circuit comprised of R123, R124, R128, R129, R130, R133, R134 and Q20. This is a standard common emitter transistor inverter with a biased network on the output comprised of R133 and R134 to provide a reverse sawtooth signal which goes from +1.75VDC to -1.75VDC (unloaded).

A minus 5 volt regulator comprised of the voltage divider R9, R10 and emitter follower comprised of IC2, R11, R8 and Q1 provides a precision -5 volt potential for the octave switching network shown to the far left of the schematic. This circuit has remote sense via pin 18A to eliminate effects of edge connector voltage offsets.

Combined sawtooth and triangular waveforms are achieved by the mix resistor shown to the right-hand side of the schematic, off the printed circuit board.

It should be noted that the voltage applied to the base of exponentiating transistor Q17 is scaled so that 21.0mV equals one octave. This means that a 17.5 microvolt level on the base of Q17 is equivalent to 1 percent. If an accuracy of 1 percent is required, then all noise contributions appearing at

the base of Q17 must be kept below 17.5 microvolts. While this is not an unusually tight specification for a 741 type operational amplifier, occasional problems may be encountered. Popcorn noise or supply decoupling in the integrated circuit or supply spiking due to larger board trace resistances may lead to occasional instruments which exhibit jitter.

2.4 MODULATION MIX AMPLIFIER

There are two modulation signals available in the Minimoog; the output of Oscillator 3 and noise. Oscillator 3 produces periodic modulation utilizing triangle, sawtooth and pulse waveforms. Noise produces random modulation utilizing noise voltages in the pink and red spectrum. The Modulation Mix amplifier selects either or both modulation signals, sums them and routes them to the Modulation Amount Control in the Left-hand controller. The output of OSCILLATOR-3's WAVEFORM SELECTOR SWITCH, SW8, and the output of the NOISE SELECTOR SWITCH, SW14, are fed thru R23 and R24 respectively and to the MODULATION MIX potentiometer R3. The wiper of R23 is connected to ground and, therefore, when the MODULATION MIX potentiometer is rotated, it pans between the two modulation signals. The two ends of R3 feed the input resistors of the Modulation Mix amplifier composed of Q7, Q17 and Q18. The Modulation Mix amplifier is an inverter with a gain of 2. The output of the modulation mix amplifier is fed through R57 to the AMOUNT OF MODULATION control in the Left-Hand Controller. Resistor R38 and capacitor C14 provide phase compensation to the amplifier to suppress oscillation.

2.5 NOISE GENERATOR

The noise generator of the Minimoog uses a small signal transistor operated in the avalanche mode. The base-to-emitter junction is biased in reverse breakdown which generates white noise in the range of -60dB. This signal is amplified to produce white, pink and red noise. The noise selector switch selects white or pink noise for audio and pink or red noise for modulation. Transistor Q15 is the noise generator transistor which is selected, burned-in and retested for uniform noise clear of pops and

clicks. Resistor R47 and capacitor C25 form a noise-free bias supply for this transistor. The noise on Q15 is fed to common emitter amplifier Q12. Resistor R26 adjusts the gain of this amplifier until the white noise output is -5dB. Q4 forms an emitter follower which provides a low impedance output drive for the white noise circuit. The white noise output is filtered by R16, C3, R8, C2 and R13 to provide pink noise. Transistor Q3 amplifies the pink noise and provides a low impedance output. The pink noise output is then filtered by R12 and C7 and amplified by Q6 to provide the red noise output.

2.6 HEADPHONE AMPLIFIER

The headphone amplifier in the Minimoog is a push-pull current amplifier that provides sufficient current to drive standard 8 ohm headphones. The signal from the final VCA is fed to the headphone volume control R21. This is AC coupled through C19 through driver transistor Q16. Diodes, CR1 and CR2 provide the 1.2 voltage drop required to bias Q10 and Q11 into class AB operation. CR1 and CR2 are connected to Q10 and Q11 for temperature compensation. Audio signals are AC coupled through C21 into the headphone output jack.

2.7 POWER SUPPLY

The Minimoog employs a ± 10 volt dual regulated supply. The regulators are located on the left hand portion of Board 3, the rectifier and filter capacitors are located on Board 5, and the AC line circuitry and low voltage transformer are mounted on the chassis. The regulated supply can operate on either 115 volt or 230 volt AC line voltage selected by a rear panel line voltage switch. The supply has both primary AC line fuses and secondary DC line fuses.

Raw AC from the line cord passes through fuse F3 and to POWER switch SW20. VOLTAGE SELECTOR SW21 connects the primaries of T1 in series for 230 volt operation and in parallel for 115 volt operation. The step-down secondary voltage from T1 is applied to rectifier Board 5.

The low voltage AC is bridge rectified by diodes CR1 through CR4 on Board 5. Capacitors C1 and

C2 filter the raw DC to provide unregulated ± 15 volts. This raw output is fed through secondary fuses F1 and F2 to Board 3. Raw +15 volts is also fed to various boards in the system to provide additional power.

The power supply on the Minimoog employs two series pass voltage regulators. The +10 volts is regulated first and the -10 volts tracks the +10 voltage. The +10 voltage regulator is composed of Q1, Q2, Q5, Q8, Q9 and referenced diode CR3. Diode CR3 is the master voltage reference for the -10 volt regulator and, therefore, the master reference for the entire system. The negative voltage regulator is composed of Q13, Q14, Q19 and Q20.

The +10 volt regulator operates in the following manner: Resistor R44 feeds 7.5 milliamperes through zener diode CR3 giving a 6.2 voltage drop across CR3. This 6.2 volts is virtually insensitive to both changes in temperature and current, thereby providing a very stable voltage reference. Transistors Q9 and Q8 compare the voltage drop across CR3 with a voltage drop at the wiper of R21. To provide 6.2 volts at the wiper of R21, 10 volts must appear across the total resistor string comprised of R39 and R21 and R34. Therefore, the voltage across CR3 sets the +10 volt power supply voltage. Transistors Q8, Q9, Q5, and Q1 form a negative feedback regulator to maintain the voltage at exactly +10 volts. If the voltage on the collector of Q1 rises above 10 volts, the voltage on the bases of Q8 ends up being lower than the voltage on Q9. Transistor Q9 cuts off the drive to Q5, which reduces the drive to Q1. This brings the voltage on the collector of Q1 back to +10 volts. Variable resistor R21 sets the output voltage to precisely +10.000 volts. Transistor Q2 only operates during the initial turn on of the instrument. When the power is first applied, the collector of Q1 has no voltage on it, therefore the regulator will not function. Transistor Q2 has no drive and is, therefore, turned off allowing raw DC to be fed through R5 and R14 to the base of Q5, turning Q5 on. Transistor Q5 supplies drive to Q1, turning Q1 on causing the voltage on the collector of Q1 to rise towards +10 volts. As this voltage rises, Q2 is turned on, thereby removing the raw DC feed to Q5 allowing the regulator to operate normally. Plus 10 volts is remote sensed at the oscillator card to insure a stable oscillator voltage. Resistor R45 provides +10 volt sensing

in case the internal sense lines to the oscillator open. Without R45, the regulated voltage would jump to the raw supply voltage if the sense line opens. Resistor R45 protects the electronic circuitry from damage. The various capacitors throughout the system suppress parasitic oscillations.

The -10 volt supply is referenced to the +10 volt supply and the operation is identical to the +10 volt supply. Resistors R65, R58 and R52 form a voltage divider across the +10 and -10 volt supply rails. Transistors Q13 and Q14 compare the voltage on the wiper of R58 with ground potential. Transistors Q13 and Q14 adjust the drive to Q20 to maintain ground potential on the wiper of R58 which provides -10 volts on the rail. Variable resistor R58 adjusts the -10 voltage to precisely -10.000 volts. Again, remote sensing is used for oscillator stability with sense resistor R66 providing sense line protection and various capacitors are placed throughout the regulator to insure stable operation. Both the +10 volt and -10 volt supply voltages are applied directly to the oscillators and to Board 5 for distribution to the rest of the system.

2.8 VOLTAGE CONTROLLED FILTER

Audio signals from the three VCO's, the noise generator, and the external audio input are summed and applied to the base of Q29. Transistors Q29 and Q30 generate a differential signal current and apply it to the lowpass filter ladder. The four-pole lowpass filter ladder is a patented design consisting of the base-emitter junction of transistors Q2, Q3, Q10, Q11, Q19, Q20, Q23, Q24, and capacitors C16, C11, C7 and C3. Cutoff frequency of the filter is controlled by the standing current through the ladder. The higher the standing current, the higher the cutoff frequency. The filtered signal is taken differentially across C3 and therefore the control current is rejected. This differential signal is fed to the gain recovery amplifier consisting of Q5, Q6, Q7, and Q8 which converts the differential input to a single ended output. This is then fed to Q16 in the voltage control amplifier. The FILTER EMPHASIS control, R14, is also connected to the gain recovery amplifier to provide positive feedback at the cutoff frequency. As the amount of emphasis is increased, the Q increases until the filter breaks into a sine wave

oscillation at the cutoff frequency. The FILTER EMPHASIS control is calibrated by resistor R73.

The cutoff frequency control current originates in an linear voltage to exponential current convertor consisting of a matched NPN-PNP pair Q26 and Q28. Control voltages from the external input, the keyboard switches, modulation, and the contour generator are summed by their individual control resistors and fed to the exponential convertor. Resistor R49 sets the keyboard scale at one volt per octave and R39 calibrates the front panel filter CUTOFF FREQUENCY control.

2.9 VOLTAGE CONTROLLED AMPLIFIER

The input signal from the voltage-controlled filter is AC coupled to the base of Q16. Transistors Q16 and Q15 form a differential input transconductance multiplier. The gain of the differential amplifier is controlled by the current through Q18; the greater the current, the higher the gain. Transistor Q18 is connected to the loudness contour generator which gives the signal from the VCF its overall loudness contour. Resistor R14 adjusts the common mode rejection of the first stage to minimize pops and clicks resulting from the control voltage. The output of Q16 and Q15 is fed to another transconductance multiplier consisting of Q14 and Q13. The control voltage for this multiplier comes from the EXTERNAL LOUDNESS control input jack, J3. This shorting jack applies a positive bias which keeps the VCA stage ON when external control of loudness is not necessary. When an 1120 Foot Pedal controller or another voltage controller is plugged into J3, this internal connection is broken and the external applied control voltage controls loudness. Resistor R12 balances this stage to minimize pops and clicks. Transistors Q12 and Q17 convert the differential signal to a signal-ended output voltage which is routed to the main output and headphone output VOLUME controls. The high level output signal appears on J4 while a resistor divider consisting of R57 and R58 provide the low level output.

2.10 CONTOUR GENERATORS

The Minimoog has separate contour generators for both filter and loudness contours. Each contour

generator has its own separate ATTACK, DECAY, and SUSTAIN controls. The final decay rate is equal to the initial decay rate and is selected by means of a switch on the left hand controller. The contour generators are triggered by an internal voltage trigger from the keyboard and/or the rear panel S-trigger jack. The filter contour generator consists of the following parts:

- R-S Flip-Flop — Q1 and Q4
- Attack Time Electronic Switch — Q5
- Decay Time Electronic Switch — Q7
- Sustain Driver — Q8
- Voltage Follower — Q22 and Q21
- Trigger Driver — Q20
- Voltage Trigger Driver — Q12
- ATTACK TIME Control — R12
- DECAY TIME Control — R15
- SUSTAIN LEVEL Control — R18
- Amount of FILTER EMPHASIS Control - R17

When there is no external S-trigger applied or there are no keys depressed, the contour generator is in the off mode. In this mode, transistor Q20 is turned off and therefore, Q12 is turned on. Current is fed through R37, R35, and CR1 to the base of Q4, holding the flip-flop in the reset mode. Q12 shorts CR2 and CR7 to ground eliminating the sustain voltage and discharging C5 to ground. Therefore, the output from pin 11 of the contour generator is ground.

When any key on the keyboard is depressed, the following events occur. The keyboard trigger on pin 20 of the contour board turns Q20 on. This removes the reset voltage from the flip-flop and turns Q12 off removing the short on CR2 and CR7. The voltage rise on the collector of Q12 is AC coupled to the

base of Q1 turning the flip-flop on. This turns Q5 on putting +9.3 volts on the collector of Q5. Current is then fed through the ATTACK TIME potentiometer R12 to C5 resulting in an exponentially rising attack voltage on C5. The resistance of R12 sets the RC time constant and, therefore, the attack time. The voltage on C5 is followed by Q22 and Q21 and appears at one end of R33. When the voltage on R33 reaches approximately 5 volts, CR3 conducts, turning on Q4 and resetting the flip-flop. This turns Q5 off and turns Q7 on. C5 is then discharged through the decay control, R16, to the sustain voltage on the emitter of Q8. The resistance of R16 sets this initial decay time. The SUSTAIN LEVEL potentiometer, R18, connected to pin 12, sets the voltage on Q8 which sets the sustain level. After the initial decay time, C5 is maintained at the sustain level for as long as a key is depressed.

When all keys are released, the contour generator goes into the final decay mode. There are two final decay modes available which are selected by the final DECAY switch on the Left Hand Controller. In the final DECAY ON position, CR7 is open circuited. When all the keys are released, the emitter of Q8 is shorted to ground and C5 is discharged through R15 resulting in a final decay constant rate to the initial decay. In the final DECAY OFF position, CR7 is coupled through a 1.5K resistor to the collector of Q12. When all the keys are released, Q12 discharges C5 abruptly resulting in no final decay. The output from pin 11 is passed through the AMOUNT OF CONTOUR control R17 and then to pin 16 on board number 4. The AMOUNT OF CONTOUR control adjusts the sweep of the voltage controlled low pass filter.

The loudness contour generator is composed of the following parts:

- Set Reset Flip-Flop — Q25 and Q15
- Attack Time Electronic Switch — Q16,R13
- ATTACK TIME Control — R13
- Decay Time Electronic Switch — Q13
- DECAY TIME Control — R16

- Voltage Follower — Q3 and Q2
- Sustain Driver — Q19
- SUSTAIN LEVEL Control — R19

The loudness contour section also utilizes Q20 and Q12, the trigger drivers and the final decay switch. Operation of this circuit is identical to the filter contour generator.

Both contour generators are driven from a decoupled supply circuit which is derived from the +15 raw DC voltage. Since the timing capacitors can generate 10 milliampere charging spikes, the decoupling circuit keeps these spikes off the regulated $\pm 10V$. The base of Q26 is referenced to the +10 voltage so a +9.3 voltage follower appears at the emitter. An external S-trigger is connected to the base of Q12 through R42 for use with such accessories as the Moog SAMPLE and HOLD and RIBBON CONTROLLER.

2.11 A-440 REFERENCE OSCILLATOR

The A-440 Reference Oscillator in the Minimoog is based on a standard Wien Bridge oscillator design. The Wien Bridge consists of the following parts; R17, C13, R68, R71, C19, R55, and R50. The input of the bridge is connected to the collector of Q9 and the output of the bridge is connected to the base of Q22, where it is amplified by Q22 and phase inverted by Q9. At approximately 440Hz the Wien Bridge has a phase shift of zero degrees, supplying positive feedback, and the circuit will oscillate. The frequency of the oscillation is set by R68. Capacitors CR3, CR4, C12, and resistor R27 limits the signal amplitude at the collector of Q22 resulting in a clean sine wave. Transistor Q4 buffers the output to reduce circuit loading and provides a low impedance drive to the VCA. The A-440 switch, SW18, activates the A-440 reference oscillator by connecting the + rail to +10 volts.

2.12 EXTERNAL PREAMPLIFIER AND OVERLOAD LAMP DRIVER

The external preamplifier signal is fed into J6 to EXTERNAL INPUT VOLUME control R9. The

output of R9 is fed through R78 and C23 to the base of Q27. Transistors Q27, Q32, and Q33 form a 200 gain amplifier. The output of Q33 is fed through C20 to the EXTERNAL INPUT ON/OFF switch, SW10. This switch allows an external source to be summed with the other signal sources. The output of Q33 is also fed to the overload lamp driver circuit. Transistor Q25 detects the amplitude envelope of the signal and feeds that to voltage divider R56 and R48. Q33 follows this voltage and applies it to the base of Q34. When the AC input voltage on Q25 reaches approximately 1.2 volts, Q34 turns on lighting the OVERLOAD lamp, B1. R56 and R48 set the trigger threshold and CR14 holds the OVERLOAD lamp on for a suitable time period.

2.13 OLD MINIMOOG OSCILLATOR BOARD (SERIAL NUMBERS BELOW 10175)

The Minimoog oscillator board contains three independent voltage control oscillators which produce sawtooth, triangle, and pulse wave forms. The master TUNE control is provided to transpose the entire instrument. Oscillators two and three have individual tune controls for transposing individual oscillators. Each oscillator also has its own independent octave and waveform select switches. In addition, oscillator three can also be used for modulation purposes.

2.14 -5 VOLT REFERENCE SUPPLY

The -5 volt reference supply is derived from the -10 volt rail and is used as a reference voltage on the oscillator board. Resistors R173 and R177 divide the -10 volt supply to -5 volts and apply that to the buffer IC9 and Q38. The -5 volts appears at the emitter of Q38 and is routed through the harness to the octave switches and then back to the oscillator board. The -5 volts is remote sensed at the octave switches to compensate for connector resistance.

2.15 OCTAVE SWITCHES

Current from the -5 volt supply flows through the octave resistors, R25 to R26, and then through R169 and R168 to ground. Resistor R168 varies the voltage drop across the octave resistors which adjust the octave scaling. One voltage divider is shared by

all three octave switches. The output voltage from each octave switch goes through its own separate operational amplifier buffer to each one of the oscillators.

2.16 OSCILLATOR ONE

Voltages from the pitch bend wheel, tune potentiometer, keyboard, modulation wheel, external oscillator input, and the octave switch are summed and inverted by IC1. This voltage is applied to an exponential current convertor consisting of transistors Qa, Qb, and Qc. The exponential convertor consists of two major parts; exponentiating transistor, Qa, and a constant current reference consisting of Qb, Qc, and IC3. As the input voltage on IC1 increases, the output of IC1 decreases, causing the emitter voltage on Qb to decrease, in turn causing the collector current of Qa to increase. A one volt increase on the keyboard voltage input causes a 20mV decrease at the output of IC1 which generates a one octave increase in collector current from Qa. This gives the oscillator the scale factor of one volt per octave frequency change. The exponential characteristic of Qa is not perfect since there is a scale factor change with temperature. TC resistor, R20, changes the gain of IC1 with temperature to compensate for this effect. Also, because of base resistance in the transistors, the exponential relationship tends to flatten at higher frequencies. Resistor R42 applies positive feedback around IC1 to compensate for this effect. Resistor R11 sets the frequency of the oscillator and R8 sets the keyboard scale for one volt per octave. An RC network across R78 phase compensates to maintain AC stability.

The oscillator is a precision sawtooth relaxation oscillator consisting of timing capacitor C1, and 2 x FET input amplifier consisting of Q7, Q8, Q9, Q4, and Q3, a Schmitt trigger consisting of Q5 and Q6, and discharge transistor Q10. The cycle starts with C1 fully discharged and Q10 off. This leaves the input of the FET amplifier at zero volts and the collector of Q3 at +4 volts. Transistor Qa pulls a constant current out of C1 causing a linearly decreasing ramp voltage. When the voltage on C1 reaches -4 volts, the voltage on the collector of Q3 also reaches -4 volts. This causes the Schmitt trigger, Q5 and

Q6 to fire, turning on transistor Q10 which resets C1 to zero. Therefore, a +4 volt to -4 volt sawtooth appears on the collector of Q3. The frequency of the oscillator is controlled by the current coming from Q3; the higher the current, the higher the frequency. The amplitude of sawtooth generator is divided by R33 and R34 and applied to the waveform switch.

The triangle wave is derived from the original sawtooth by Q2. The +4 volts on the collector of Q3 causes the base-to-collector junction of Q2 to be forward biased resulting in +3.3 volts on the collector of Q2. This voltage will follow sawtooth voltage until the sawtooth passes zero volts. Then Q2 switches state causing the base-to-emitter junction to forward bias forming an inverter. As the voltage on the base of Q2 continues to drop, the voltage on the collector of Q2 will rise, generating a triangle waveform. Transistor Q1 buffers the output and sends that to the waveform switch.

The variable duty-cycle pulse is also derived from the sawtooth by Schmitt trigger transistors Q11 and Q12. The sawtooth is summed with a bias voltage by R1 and R40. The bias voltage causes the Schmitt trigger to fire at a specific point on the sawtooth. Changing the bias voltage generates a variable duty-cycle pulse. This pulse width is controlled by the waveform switch and varies from a 50 percent to a 15 percent duty cycle.

All waveforms are sent to the WAVEFORM select switch, SW6, the LEVEL control R45, and the OSCILLATOR ON/OFF switch SW9. Resistors R32, R33, and R34 supply the bias voltages for the pulse width circuit. Resistors R36 and R37 on the WAVEFORM select switch sum the sawtooth and triangle to generate another waveform.

2.17 OSCILLATOR TWO

Oscillator two is identical to oscillator one with one exception. Oscillator two has its own tune potentiometer so that it can be varied in frequency from oscillator one.

2.18 OSCILLATOR THREE

Oscillator three can be used as a tone oscillator or as a modulation oscillator. A switch, SW2,

interrupts the keyboard, modulation, external, and pitchbend voltage on oscillator three and also increases the range of the oscillator three's tune control. This allows oscillator three to be used as a wide range modulation oscillator. Transistor Q37 inverts the sawtooth of oscillator three and applies that to the WAVEFORM select switch so this waveform can also be used for modulation.

2.19 KEYBOARD CIRCUIT

The keyboard circuit generates a low note priority pitch voltage and a +10V (V-Trig) to ground every time a key is depressed. The keyboard circuit consists of three parts: a temperature compensated current source, the actual keyboard, and the track and hold amplifier.

Transistors Q9 and Q11 form the temperature compensated current source. Resistors R20 and R21 apply +5 volts to the base of Q11. Since Q9 and Q11 are complimentary matched NPN/PNP pairs, +5 volts appears at the emitter of Q9. This causes 8.5 milliamperes to flow through R1, out the collector of Q9, and through the 43 resistors in the keyboard string to ground. This current flowing through the 10 ohm resistors in the keyboard string gives the characteristic 1.0 volt per octave keyboard voltage. Since the low end of the keyboard is grounded, the keyboard voltage is the lowest note depressed giving low note priority. The matched pair of transistors result in temperature compensation and C3 stops parasitic oscillations in the two transistors.

The keyboard voltage is routed to a track and hold amplifier consisting of differential amplifier

Q23, Q24, and Q14, sampling switch Q13, storage element C6, and output buffer Q10. With no keys depressed, the circuit is in the "hold" mode. The gate of Q13 is pulled down to -10 volts by CR5 and R34, this turns Q13 off, C6 holds its "tracked" voltage and Q10 follows this voltage. When any key is depressed, two things happen: the pitch voltage appears at the base of Q23 and +10 volts from the trigger buss appears on the junction of CR5 and R34. This reverse biases CR5, turning Q13 on, which closes the amplifier feedback loop. Q24 then charges or discharges C6 until the voltage on the source of Q10 equals the input pitch voltage. Therefore, the circuit has "tracked" the input voltage. Capacitor C6's charge time depends on the resistance of the GLIDE potentiometer connected between pins 7 and 8 of the printed circuit board connector. With no resistance (with the GLIDE switch off, for example) Q24 can charge C6 very rapidly resulting in an instant pitch change. As the resistance is increased, the charge time for C6 is increased resulting in the familiar "Portamento" effect. When the key is released, Q13 is turned off and the pitch voltage is held. The keyboard is mechanically set up so that the pitch voltage always occurs before the trigger and that the trigger goes off before the pitch voltage is released. This insures that the pitch voltage is constant when the amplifier goes from the "track to hold" mode, and a reliable pitch voltage is held. When no keys are depressed, R53 saturates the input of the differential amplifier putting +10 volts on the collector of Q14. This insures that Q13 will remain pinched off, thereby holding the voltage on C6. Capacitor C9 slows down the voltage on the input of Q23 to minimize switch bounce noise.

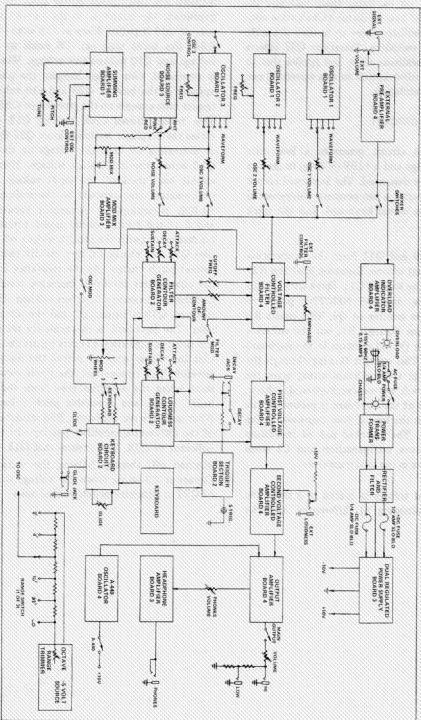

FIGURE 2-1 100-WATT RF POWER TRANSMITTER

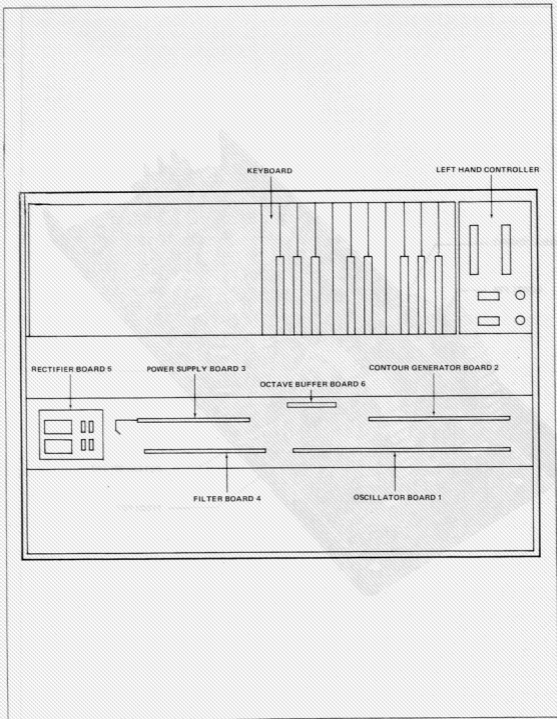

FIGURE 2-2 SUBASSEMBLY LOCATION DIAGRAM

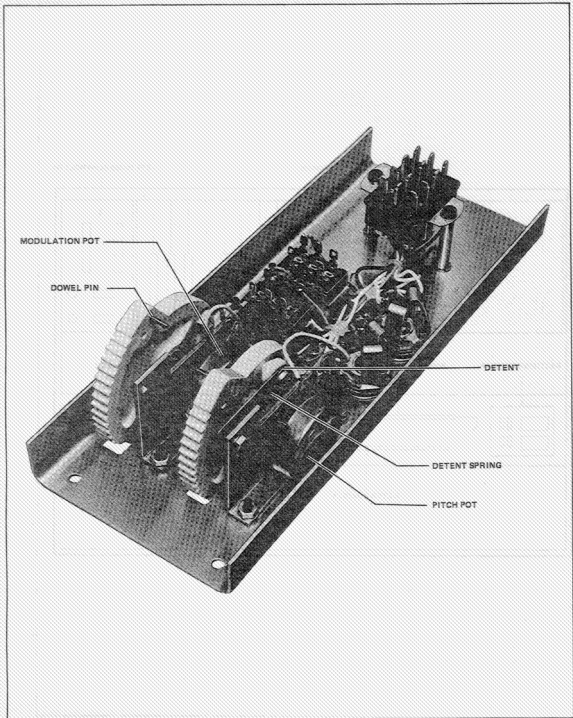

FIGURE 2-4 LEFT HAND CONTROLLER

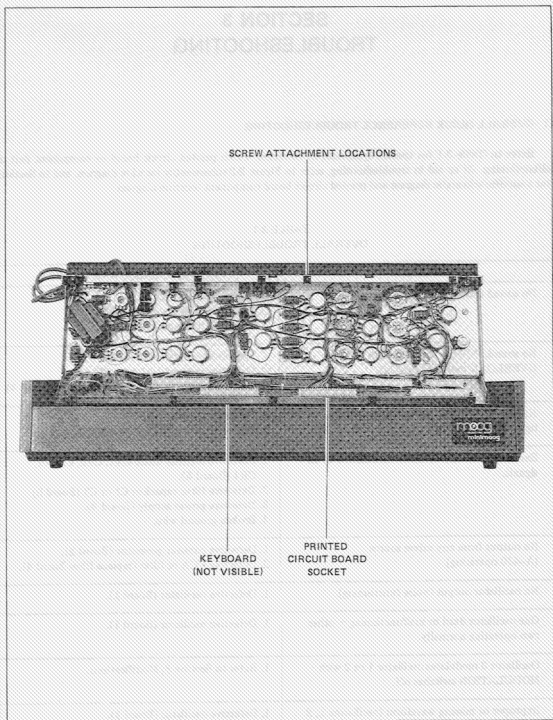

FIGURE 2-3 PRINTED CIRCUIT BOARD SOCKET LOCATION

SECTION 3

TROUBLESHOOTING

3.1 OVERALL QUICK REFERENCE TROUBLESHOOTING

Refer to Table 3-1 for specific symptoms to determine which printed circuit board or component part is malfunctioning. As an aid in troubleshooting, refer to Figure 2-2 subassembly location diagram, and to Section 9 for a specific schematic diagram and printed circuit board component location diagram.

TABLE 3-1
OVERALL TROUBLESHOOTING

SYMPTOM	PROBABLE CAUSE AND REMEDY
No sound and POWER indicator light off.	<ol style="list-style-type: none"> 1. Blown AC fuse F3. 2. Defective POWER switch SW20. 3. Defective line cord or plug.
No sound, POWER indicator light on and OVERLOAD indicator light off.	<ol style="list-style-type: none"> 1. Defective power supply (Board 3). 2. Defective power transformer T1. 3. Defective output amplifier (change filter Board 4).
No sound, POWER and overload indicator lights on.	<ol style="list-style-type: none"> 1. Blown DC fuse F1 or F2. 2. Defective Power Supply (Board 3).
Excessive hum and constant modulation of all signals.	<ol style="list-style-type: none"> 1. Defective rectifier diode CR1, CR2, CR3 or CR4 (Board 5). 2. Defective filter capacitor C1 or C2 (Board 5). 3. Defective power supply (Board 3). 4. Broken ground wire.
No output from any mixer source (A-440 operating).	<ol style="list-style-type: none"> 1. Defective contour generator (Board 2). 2. Defective VCA or filter (replace filter Board 4).
No oscillator output (noise functioning).	<ol style="list-style-type: none"> 1. Defective oscillator (Board 1).
One oscillator dead or malfunctioning — other two operating normally.	<ol style="list-style-type: none"> 1. Defective oscillator (Board 1).
Oscillator 3 modulates oscillator 1 or 2 with MODULATION switches off.	<ol style="list-style-type: none"> 1. Refer to Section 8, Modifications.
Improper or missing waveform (oscillators 1, 2 or 3).	<ol style="list-style-type: none"> 1. Defective oscillator (Board 1). 2. Defective WAVEFORM switch.

**TABLE 3-1
OVERALL TROUBLESHOOTING (Continued)**

SYMPTOM	PROBABLE CAUSE AND REMEDY
Noise source dead or producing poor quality noise.	1. Defective noise transistor Q15 (Board 3). 2. Defective noise generator (replace power supply Board 3).
No external input.	1. Defective pre-amplifier (replace filter Board 4).
Filter inoperative or malfunctioning.	1. Defective filter (Board 4).
Filter regeneration weak or absent (EMPHASIS at 10).	1. Defective filter (Board 4). 2. "Regen Cal" R73 not adjusted properly.
Excessive drift or pitch change after key is released (greater than 1 semitone per minute).	1. Replace 2N4303 (Q13 or Q10) on contour generator (Board 4).
Loudness and/or filter contour generator operating improperly.	1. Defective contour generator (Board 2).
No output at PHONES jack (main output normal).	1. Monaural plug in stereo headphone jack. 2. Defective headphone amplifier (replace power supply Board 3).
OVERLOAD light fails to operate when excessive signal is applied.	1. Defective bulb. 2. Defective lamp driver circuit (replace filter Board 4).
Thumping sound heard when depressing a key (AMOUNT OF CONTOUR at 0).	1. First VCA out of balance. Refer to Section 5. 2. Defective VCA (replace filter Board 4). 3. Refer to Section 8, Modifications.
Keyboard glides when glide is off.	1. Defective keyboard circuit (replace contour generator Board 2).
Unit cannot be tuned ("A-440" on frequency within 1Hz).	1. Defective oscillator (Board 1). 2. Defective keyboard circuit (replace contour generator Board 2).
Unit cannot be tuned ("A-440" off frequency more than 5Hz).	1. Power supply voltages improperly adjusted. 2. Defective power supply (Board 3).
"A-440" reference oscillator dead (other outputs normal).	1. Defective reference oscillator (replace filter Board 4).
Scale and tracking problems.	1. Replace 3046, IC2 and IC7, on oscillator (Board 1).

TABLE 3-1
OVERALL TROUBLESHOOTING (Continued)

SYMPTOM	PROBABLE CAUSE AND REMEDY
No modulation (filter or oscillator).	<ol style="list-style-type: none"> 1. Defective modulation mix amplifier (replace power supply Board 3). 2. Defective MOD wheel control. 3. Bad "Flag" contacts at Cinch-Jones connectors. Refer to Section 8, Modifications.
RANGE switches have little or no effect.	<ol style="list-style-type: none"> 1. Octave Range misadjusted. 2. -5 volt source defective (replace oscillator Board 1).
Noise or static when turning a control.	<ol style="list-style-type: none"> 1. Control dirty — spray clean. 2. Control worn out — replace.
Noisy intermittent or non-functioning left-hand controller.	<ol style="list-style-type: none"> 1. Connector corrosion: Use a dry cotton swab or eraser to clean contacts.
Intermittent or constant modulation bleed through when modulation switch is in the off position from oscillator 3.	<ol style="list-style-type: none"> 1. Connector or printed circuit board connector corrosion: Clean with eraser and selectively adjust flag lugs not making contact. If this fails, selectively solder wire to individual flag lugs; isolate by slightly moving each wire. Refer to Section 8, Modifications.

3.2 OSCILLATOR PRINTED CIRCUIT BOARD 1 TROUBLESHOOTING (Serial Numbers 10175 and Above)

Refer to Table 3-2 to determine which component part of the printed circuit board is malfunctioning for a specific symptom. As an aid in troubleshooting, refer to applicable schematic and printed circuit board diagrams in Section 9.

TABLE 3-2
OSCILLATOR PRINTED CIRCUIT BOARD 1 TROUBLESHOOTING (Serial Numbers Above 10175)

SYMPTOM	PROBABLE CAUSE IN ORDER OF OCCURRENCE
All 3 oscillators dead.	IC2 (741) (-5V source).
Oscillator 1 dead.	IC5 (726), IC6 (TL081), IC8 (393), N2 resistor network, R23 (2.32K).
Oscillator 2 dead.	IC10 (726), IC11 (TL081), IC13 (393), CR3 (1N4148), R63 (2.32K).
Oscillator 3 dead.	IC5 (726), IC16 (TL081), IC18 (393), R101 (2.32K).

TABLE 3-2
OSCILLATOR PRINTED CIRCUIT BOARD 1 TROUBLESHOOTING (Continued)

SYMPTOM	PROBABLE CAUSE IN ORDER OF OCCURRENCE
OSCILLATOR 1	
<p>Will not tune on "Scale", "Octave" and "Hi End".</p> <p>High frequency (screams).</p> <p>Low frequency.</p> <p>Jitters.</p> <p>No low frequency.</p> <p>No triangular waveform output.</p> <p>No rectangular waveform output.</p> <p>Glitch in triangular waveform.</p> <p>No shift in frequency</p>	<p>IC5 (726).</p> <p>N2 resistor network, IC6 (TL081), C7 (.001uf), C12 (18Pf).</p> <p>N2 resistor network.</p> <p>IC6 (TL081), Q4 (E112), C7 (.001uf), C12 (18Pf).</p> <p>Q4 (E112), C7 (0.001uf).</p> <p>IC4 (1458), Q6 (2N3904).</p> <p>C14 (.01uf).</p> <p>Q4 (E112), C7 (.001uf).</p> <p>R14 (10K).</p>
OSCILLATOR 2	
<p>Will not tune on "Scale", "Octave" and "Hi End".</p> <p>High frequency (screams).</p> <p>Jitters.</p> <p>No low frequency.</p> <p>No triangular waveform output.</p> <p>No triangular and sawtooth waveform output.</p> <p>Glitch in triangular waveform.</p>	<p>IC10 (726).</p> <p>N3 resistor network, IC11 (TL081), C18 (.001uf), IC3 (1458).</p> <p>IC11 (TL081), Q9 (E112), C18 (.001uf).</p> <p>Q9 (E112), C18 (.001uf).</p> <p>IC9 (1458).</p> <p>IC11 (TL081).</p> <p>Q9 (E112), C18 (.001uf), IC12 (TL081).</p>
OSCILLATOR 3	
<p>Will not tune on "Scale", "Octave", and "Hi End".</p> <p>High frequency (screams).</p> <p>Jitters.</p> <p>No low frequency.</p> <p>No triangular waveform output.</p> <p>Reversed sawtooth waveform.</p> <p>All waveforms distorted.</p> <p>Glitch in triangular waveform.</p>	<p>IC10 (726).</p> <p>IC16 (TL081), Q14 (E112), C29 (.001uf).</p> <p>IC16 (TL081), Q14 (E112), C19 (.001uf).</p> <p>Q14 (E112), C29 (.001uf), IC15 (726).</p> <p>IC14 (1458).</p> <p>Q20 (2N3904), R113 (100K).</p> <p>IC17 (TL081).</p> <p>Q14 (E112), C18 (.001uf), IC17 (TL081).</p>

SECTION 4

DISASSEMBLY PROCEDURES

4.1 DISASSEMBLY

Prior to disassembly, perform the following procedures.

CAUTION

Ascertain that the instrument is disconnected from the power source before disassembly.

In order to service the Minimoog circuitry, it is necessary to remove the rear cover assembly. Remove 18 screws (5 top, 5 lower back, and 4 each end of cover); then lift the cover off.

Circuit boards are plugged into sockets (Figure 2-3) at the bottom and secured at the top with two mounting screws. To remove a circuit board, first re-

move the screws then unplug from connector. When replacing, be sure board is firmly seated in the connector before tightening the mounting screws. Remember to reinstall the fiber washers between the boards.

If necessary to remove the keyboard, proceed as follows:

Remove the eight wood screws securing the bottom cover and remove the cover. This exposes the bottom side of the keyboard, the two lateral keyboard supports and the four screws securing the keyboard. A disconnect plug on the left side of the lower support connects the wiring to the keyboard. Remove the tie around the plug and receptacle and separate the two, then remove the four screws that hold the keyboard. Carefully tilt the keyboard sufficiently to permit removal from the bottom of the circuit.

SECTION 5

ADJUSTMENT AND TUNING

5.1 PRINTED CIRCUIT BOARD REPLACEMENT ADJUSTMENTS

Each time a Minimoog is serviced, the tuning should be verified. When a board has been replaced it will be necessary to make additional adjustments. Refer to Table 5-1 to determine which adjustments must be made according to the board that has been replaced and refer to paragraphs 5.3.1 through 5.3.4 and Tables 5-2 through 5-4 as applicable, for a specific adjustment. Refer to Section 4 for the necessary procedures to be performed prior to printed circuit board removal.

**TABLE 5-1
PRINTED CIRCUIT BOARD REPLACEMENT ADJUSTMENTS**

WHEN REPLACING	MAKE THESE ADJUSTMENTS
Oscillator Board 1	1. Oscillator 1, 2 and 3 tuning.
Contour Generator Board 2	1. Check tuning (adjust if necessary).
Power Supply Board 3	1. +10 volts. 2. -10 volts. 3. Noise level. 4. Check tuning (adjust if necessary).
Filter Board 4	1. VCA balance (1 and 2). 2. "A-440" frequency. 3. Regeneration calibration. 4. Filter range. 5. Filter scale.
Left Hand Controller	1. Check function (adjust if necessary).
Keyboard	1. Check function (adjust if necessary).

5.2 VOLTAGE ADJUSTMENTS

Tuning and other functions rely heavily on accurate power supply voltages. Always be sure the +10 volt and - 10 volt supplies are properly set before making other adjustments. Refer to Table 5-2, Figures 5-1 through 5-5 (adjustment location diagrams) and applicable schematic and printed circuit board diagrams in Section 9.

**TABLE 5-2
VOLTAGE ADJUSTMENTS**

TO ADJUST	FOLLOW THESE PROCEDURES
+10 volts	Connect 3-1/2 digital DC voltmeter (0.1% accuracy) to pins 1A and 2A on the oscillator (Board 1). Adjust the +10V trimpot on the power supply (Board 3) for +10.00 volts.
- 10 volts.	Connect 3-1/2 digital DC voltmeter (0.1% accuracy) to pins 2A and 3A on the oscillator (Board 1). Adjust the -10V trimpot on the power supply (Board 3) for -10.00 volts.
A-440 Board 4 Reference Oscillator.	Turn on A-440 and allow to warm up for two minutes. Adjust A-440 trimpot on the filter (Board 4) for zero beat with an "A" tuning fork. By bringing the struck tuning fork in physical contact with the shell of a pair of headphones, while listening to the A-440 output, the beat note becomes more audible.

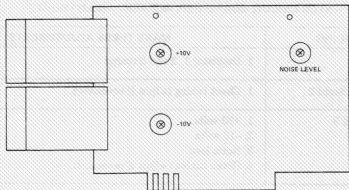

FIGURE 5-1 POWER SUPPLY ADJUSTMENT LOCATION DIAGRAM

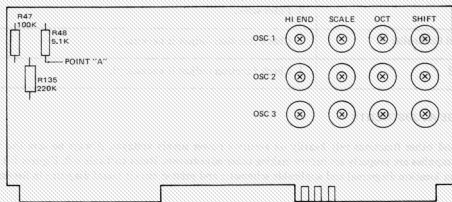

FIGURE 5-2 REAR PANEL TUNING CONTROL LOCATION DIAGRAM (SERIAL NUMBERS 10175 AND ABOVE)

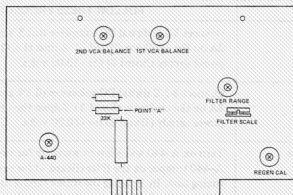

FIGURE 5-3 FILTER ADJUSTMENT LOCATION DIAGRAM

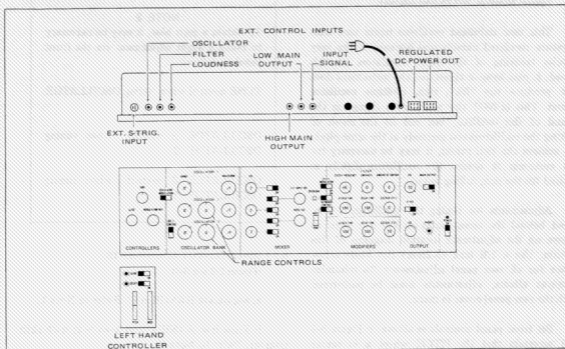

FIGURE 5-4 FRONT PANEL CONTROL SETTINGS (SERIAL NO. 10175 AND ABOVE)

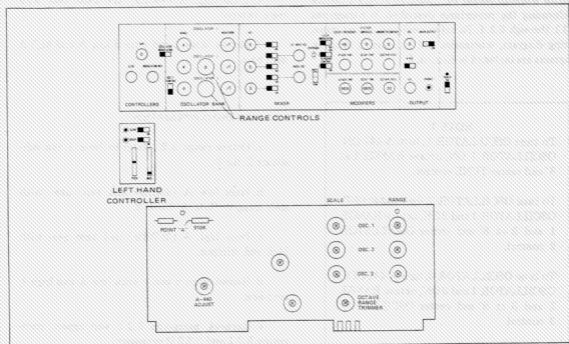

FIGURE 5-5 FRONT AND REAR PANEL ADJUSTMENT LOCATION (SERIAL NO. 10175 AND BELOW)

5.3 TUNING THE OSCILLATORS (Serial Number 10175 and Above)

This new stabilized oscillator board uses temperature regulated circuits and because of the very precise tracking of the three oscillators on this board, it may seem at times that the instrument does not produce the "fat", rich, multiple oscillator sound. This is NOT the result of a change in the sound of the oscillator but can be the result of setting the oscillators too precisely at the same pitch. To achieve the rich sound, it may be necessary for the customer to detune the oscillators slightly as desired for the rich, rolling sound.

Adjustments for tuning the oscillators are located behind the access holes on the rear panel as shown on the adjustment location diagrams of this section. Use a 1/8 inch (3.2mm) flat blade screw driver for all rear panel adjustments. To minimize spurious effects, adjustments must be performed with the rear panel cover in place.

Set front panel controls as shown in Figure 5-4 and ascertain that the PITCH wheel is in center position. Turn POWER switch ON and allow a 30 minute warmup period for optimum accuracy before performing the procedures described in paragraphs 5.3.1 through 5.3.4. To aid in servicing, a front panel wiring diagram, schematics and component location diagrams are included in Section 9.

NOTE 1

To tune OSCILLATOR 1, turn A-440 ON, OSCILLATOR 1 ON, octave RANGE 1 at 8' and center TUNE control.

To tune OSCILLATOR 2, turn A-440 OFF, OSCILLATOR 1 and 2 ON, octave RANGE 1 and 2 at 8' and center OSCILLATOR 2 control.

To tune OSCILLATOR 3, turn A-440 OFF, OSCILLATOR 1 and 3 ON, octave RANGE 1 and 3 at 8' and center OSCILLATOR 3 control.

NOTE 2

To obtain a zero beat, it may be necessary to make a slight adjustment on the front panel as follows:

TUNE control when tuning OSCILLATOR 1.

OSCILLATOR 2 control when tuning OSCILLATOR 2.

OSCILLATOR 3 control when tuning OSCILLATOR 3.

5.3.1 SCALE TRIMPOT ADJUSTMENTS

(Figures 5-2 and 5-4)

- Set octave RANGE at 8'. Refer to Note 1.
- Press low A (55Hz) and zero beat with shift trimpot. Refer to Note 2.
- Press high A (440Hz) and zero beat with scale trimpot.
- Repeat steps b and c until low A and high A zero beat.

5.3.2 HIGH END COMPENSATION

- Octave range is 2'. Refer to Note 1 and substitute 2' for 8'.
- Press low A (440Hz) and zero beat with shift trimpot. Refer to Note 2.
- Press high A (3520Hz) and zero beat with high end trimpot.
- Repeat steps b and c until low A and high A zero beat.
- Recheck paragraph 5.3.1 and repeat paragraphs 5.3.1 and 5.3.2 if necessary.

5.3.3 OCTAVE ADJUSTMENT

a. Octave RANGE is 32'. Refer to Note 1 and substitute 32' for 8'.

b. Press high A (220Hz) and zero beat using shift trimpot. Refer to Note. 2.

c. Octave RANGE is 2'. Refer to Note 1 and substitute 2' for 8'.

d. Press high A (3520Hz) and zero beat using octave trimpot.

e. Repeat steps a, b, c, and d until both 32' and 2' zero beat.

5.3.4 SHIFT TRIMPOT ADJUSTMENT

Press A³ (440Hz) and zero beat using shift trimpot. Refer to Note 1. Oscillators are now in tune.

5.4 TUNING THE OSCILLATOR (Serial Numbers Below 10175)

The Minimoog can be tuned to an exacting degree. Under ideal studio conditions, the initial factory tuning of the instrument should be sufficient for a considerable length of time. However, in situations where the instrument is moved often and exposed to varied weather conditions, retuning may be

required. Over a long period of time the A-440 reference oscillator may require adjustment. Provision is made for easy tuning of all oscillators.

Adjustments for tuning the oscillators are located behind the access holes on the rear panel. Use a 1/8 inch (3.2mm) flat blade screwdriver for all rear panel adjustments. To minimize spurious effects, adjustments must be performed with the rear panel cover in place.

Ascertain that the PITCH wheel is in center position. Turn POWER switch ON and allow 30 minute warmup period for optimum accuracy before performing the procedure specified in Table 5-3. To aid in servicing, a front panel wiring diagram, schematics and printed circuit board diagrams are included in Section 9.

5.5 DETAILED ADJUSTMENT PROCEDURES (All Serial Numbers)

The adjustment procedures specified in Table 5-4 apply for all Minimoogs. Adjustments for tuning the oscillators, power supply and filter are located behind access holes on the rear panel. Use a 1/8 inch (3.2mm) flat blade screwdriver for all these adjustments. Refer to Figures 5-1 through 5-5 for location of adjustment trimpots. To aid in servicing, a front panel wiring diagram, schematics, and printed circuit diagrams are included in Section 9.

Before performing these procedures, read instructions specified in paragraph 5-4.

TABLE 5-3
OSCILLATOR TUNING PROCEDURE
(Serial Numbers Below 10175)

TO ADJUST	FOLLOW THESE PROCEDURES
Oscillator Tuning With Equipment	<ol style="list-style-type: none"> 1. Connect a frequency counter to the HIGH MAIN OUTPUT jack. (Top of front panel). 2. Ascertain that PITCH wheel is in center position. 3. Set TUNE control to 0, RANGE switches to 2' and WAVEFORM switches to Δ. 4. Set MIXER VOLUME controls to 4. 5. Turn OSCILLATOR MODULATION switch to OFF and OSC. 3 CONTROL switch to on. 6. Set OSCILLATOR 2 and 3 FREQUENCY controls to mid-position. 7. Set MIXER OSCILLATOR 1 switch ON. 8. Adjust oscillator 1 Range trimpot (rear panel Figure 5-5) for 3520Hz while holding high "A" key down. 9. Depress and hold low "A" while adjusting oscillator 1 <u>Scale</u> trimpot (rear panel) for 440Hz. 10. Repeat procedure until no further improvement is attainable. 11. Set MIXER OSCILLATOR switch off. 12. Repeat above procedures for oscillator 2; then repeat for oscillator 3. 13. After oscillators have been tuned properly, check tracking between any two oscillators and make any necessary warm-up adjustments to improve tracking.
Oscillator Tuning Without Equipment	<p style="text-align: center;"><u>OSCILLATOR 1</u></p> <ol style="list-style-type: none"> 1. Set front panel controls as shown in Figure 5-5 and ascertain that PITCH wheel is in center position. 2. Turn POWER switch ON and allow 30-minute warm-up period for optimum accuracy. 3. Turn A-440 switch on. 4. Set MIXER OSCILLATOR 1 switch to ON. 5. Depress high "A" and zero beat with A-440 using oscillator 1 <u>Range</u> trimpot (rear panel). Fine tune with front panel TUNE control. 6. Depress low "A" and zero beat using <u>Scale</u> trimpot (rear panel, Figure 5-5). 7. Depress high "A". Observe that adjustment of <u>Scale</u> trimpot has slight effect on <u>Range</u> trimpot adjustment. 8. Repeat steps 4, 5, and 6 until perfect unison is obtained.

TABLE 5-3
OSCILLATOR TUNING PROCEDURE (Continued)
 (Serial Numbers Below 10175)

TO ADJUST	FOLLOW THESE PROCEDURES
Oscillator Tuning Without Equipment (Continued)	<p style="text-align: center;"><u>OCTAVES</u></p> <ol style="list-style-type: none"> 1. With OSCILLATOR 1 ON and high "A" depressed, turn front panel OSCILLATOR 1 RANGE switch from 4' to 32' and zero beat using Octave trimpot (rear panel). 2. Turn OSCILLATOR 1 RANGE switch from 32' to 2'. 3. Depress low "A" and zero beat using TUNE control. Observe that adjustment of TUNE control has slight effect on <u>Octave</u> trimpot adjustment. 4. Repeat steps 1, 2 and 3 until perfect unison is obtained.
	<p style="text-align: center;"><u>OSCILLATORS 2 AND 3</u></p> <ol style="list-style-type: none"> 1. Turn A-440 switch off and OSCILLATOR 2 ON. 2. Turn OSCILLATOR 2 RANGE switch to 4'. 3. Depress high "A" and zero beat using <u>Range 2</u> trimpot (rear panel). 4. Depress low "A" and zero beat using <u>Scale</u> trimpot. 5. Repeat steps 1 through 4 using OSCILLATOR 2 TUNE control until perfect unison is obtained. 6. Repeat steps 1 through 5 for OSCILLATOR 3 tuning.

TABLE 5-4
ABBREVIATED ADJUSTMENT AND TUNING PROCEDURES
 (All Serial Numbers)

TO ADJUST	FOLLOW THESE PROCEDURES
Noise Level	Noise level is factory-set to yield -5dB maximum in the white position. If the level becomes low it may be increased by counterclockwise rotation of the <u>Noise Level</u> trimpot (Figure 5-1, power supply, Board 3). It may be necessary to use an offset screwdriver to reach this trimpot.
VCA Balance	Turn all MIXER switches off. Connect headphones and set VOLUME fully clockwise. Connect a jumper from point "A" on the filter board (Figure 5-3) to point "A" on the oscillator board (Figure 5-2). While listening to the headphones, adjust the <u>2nd VCA Balance</u> trimpot on the filter board (Figure 5-3) for the minimum audio signal. Depress and hold a key. Adjust the <u>1st VCA Balance</u> trimpot for minimum audio signal. Remove the jumper.
Regeneration Calibration	Turn all MIXER switches off. Monitor output with headphones. Set CUTOFF FREQUENCY control to -1. Insert an S-Trigger plug. Rotate FILTER EMPHASIS control clockwise. Regeneration should start when the FILTER EMPHASIS control is between 7 and 8. If it does not, set FILTER EMPHASIS control to 7.5 and rotate the <u>Regen Cal</u> trimpot on filter board (Figure 5-3) slowly clockwise until regeneration just starts.
Filter Range	Turn KEYBOARD CONTROL switches 1 and 2 off. Set CUTOFF FREQUENCY at -1, FILTER EMPHASIS at 10. Turn on A-440 and adjust <u>Filter Range</u> trimpot on filter board (Figure 5-3) for zero beats.
Filter Scale	Set CUTOFF FREQUENCY to -1, FILTER EMPHASIS at 10, AMOUNT OF CONTOUR at 0. Turn KEYBOARD CONTROL switches 1 and 2 ON. Turn A-440 ON and depress third "A" key from the bottom. Adjust CUTOFF FREQUENCY for zero beats (two octaves above 440). Depress low "A" and adjust <u>Filter Scale</u> trimpot on filter board (Figure 5-3) for zero beats. Repeat these adjustments until the filter will track three octaves.

TABLE 5-4
ABBREVIATED ADJUSTMENT AND TUNING PROCEDURES (Continued)
(All Serial Numbers)

TO ADJUST	FOLLOW THESE PROCEDURES
PITCH Wheel	Loosen the Allen head setscrew in the PITCH wheel. Rotate PITCH wheel until it drops into the center detent. Unplug the Left Hand Control connector. Connect an ohmmeter to the orange and green wires on the pitch potentiometer. Adjust the pitch potentiometer for a reading of 15.3k ohms. Tighten the setscrew and check to see that the resistance remains between 15 and 15.6K ohms when in detent.
MOD. Wheel	Loosen the Allen head setscrew in the MOD. wheel. Rotate the modulation potentiometer fully counterclockwise. Turn MOD. wheel down to its physical limit. Retighten the setscrew.

5.6 POWER SUPPLY ADJUSTMENT

NOTE

Before attempting adjustment, refer to Paragraph 4.1 for the necessary preliminary procedures.

Using at least a 3-1/2 digit DVM, measure the +10 volt line on the oscillator board. Adjust the top trim potentiometer on the power supply board for +10.000 volts. Connect the DVM to the -10 volt line on the oscillator board and adjust the bottom trim potentiometer on the power supply board for -10.000 volts. Be sure to ground the DVM at the oscillator board since ground sensing is also accomplished there.

Using pin 2 for ground, check for +10 volts at pin 1, and -10 volts at pin 3 of the external REGULATED DC POWER OUT sockets. Refer to Figure 5-4.

5.7 A-440 ADJUSTMENT

Connect scope, frequency counter and AC voltmeter to a monitor plug inserted in HIGH MAIN OUTPUT (On Top of Panel). Turn on A-440 switch and adjust A-440 trim potentiometer (On Lower

Left Corner of the Filter Board) for $440 \pm 1\text{Hz}$ (Figure 5-3). Check to see that output is $-8 \pm 2\text{dB}$ and then turn off A-440 switch. If trim potentiometer will not adjust, compensate with a parallel capacitor across C13 to adjust pitch, or a parallel resistor across R47 to adjust level.

5.8 SIGNAL FLOW

Install S-Trigger plug, turn on OSCILLATOR-1 and check for a triangular output of $1 \pm 3\text{dB}$. Turn off OSCILLATOR-1 and repeat test for OSCILLATORS 2 and 3.

5.9 MAIN OUTPUT

Turn on an oscillator, operate the MAIN OUTPUT switch and the VOLUME control and check for proper functioning. Allow switch to remain on and VOLUME control in full clockwise position.

5.10 PHONE OUTPUT

Remove monitor plug from HIGH MAIN OUTPUT and insert half way in the front panel PHONES jack. Turn VOLUME control clockwise to maximum position. Output should be $-1 \pm 3\text{dB}$. Remove monitor plug and turn volume down to 2. Insert stereo headphones and listen for undistorted sound in both phones.

5.11 LOW MAIN OUTPUT

Insert monitor plug into LOW MAIN OUTPUT jack. Output should be -30 ± 3 dB. Turn off oscillator and return monitor plug to HIGH MAIN OUTPUT jack.

5.12 EMPHASIS CALIBRATION

Set CUTOFF FREQUENCY control to -1.1. Rotate EMPHASIS control clockwise. Filter regeneration should start when the EMPHASIS control is between 7.5 and 8.0 on the dial. If regeneration does not start in this area, adjust the Regen Cal trim potentiometer (Located on the Lower Right Corner of the Filter Board, Figure 5-3) for the proper threshold.

5.13 FILTER CUTOFF ADJUSTMENT

With CUTOFF FREQUENCY control at -1.1 and EMPHASIS control at 10, turn on A-440 and adjust Range trim potentiometer (Located on the Center Right Side of the Filter Board, Figure 5-3), for zero beats. Turn off A-440 and rotate CUTOFF FREQUENCY to a full clockwise position. The amplitude should not vary more than 2dB and frequency should increase to at least 16kHz. Rotate CUTOFF FREQUENCY control counterclockwise and check that low frequency is less than 300Hz before regeneration dies out.

5.14 FILTER SCALE

Turn on A-440 switch and the KEYBOARD CONTROL switches 1 and 2. Depress the third "A" from the bottom of the keyboard and adjust the CUTOFF FREQUENCY control for 1760Hz (beat note two octaves above A-440). Depress low "A" and adjust the Filter Scale trim potentiometer for zero beat. Repeat this until filter scale covers three octaves, zero beating at each "A".

5.15 KEYBOARD 1/3

Turn off KEYBOARD CONTROL switch number 2. Using CUTOFF FREQUENCY control, tune low "A" to 440Hz by zero beating with internal A-440. Depress high "A" key; frequency should be 880 ± 50 Hz.

5.16 EXTERNAL FILTER CONTROL

Turn off both KEYBOARD CONTROL switches. Tune filter to 440Hz and apply +2.00 volts to the external FILTER CONTROL jack. (Refer to Figure 5-4). The pitch should rise to 1760 ± 100 Hz. Remove external control voltage.

5.17 AMOUNT OF CONTOUR

Rotate AMOUNT OF CONTOUR control fully clockwise. Pitch should rise from 440Hz to 35kHz ± 10 kHz. Return AMOUNT OF CONTOUR control to 0.

5.18 FILTER CONTROL

Rotate the CUTOFF FREQUENCY control knob clockwise until the frequency rises from 440 to 1760Hz (two octaves up). A rotation of approximately 2 divisions should be required.

5.19 AMOUNT OF MODULATION

Turn on the FILTER MODULATION switch and set the MOD wheel fully up. Tune OSCIL-LATOR-3 to produce the lowest frequency square wave. Adjust CUTOFF FREQUENCY control for 440Hz when pitch is low. When pitch switches to high, check to see that frequency is a minimum of 2.4kHz. Turn off FILTER MODULATION switch.

5.20 FILTER CONTOUR

(ATTACK-DECAY-SUSTAIN)

Remove S-trigger plug and set CUTOFF FREQUENCY control to -2, AMOUNT OF CONTOUR control to 3 and FILTER SUSTAIN to 0. Hit a key repeatedly while slowly increasing the FILTER ATTACK time. Listen for increasing length of attack with sudden fall. Return ATTACK to 0 and check DECAY time in the same manner. This time listen for sudden attack with slow decay. Return DECAY control to 0. Depress and hold a key and rotate SUSTAIN control fully clockwise. The pitch should rise and hold and with release of the key, sound should diminish instantly.

5.21 DOUBLE TRIGGERING

Set AMOUNT OF CONTOUR and all LOUDNESS CONTOUR controls to fully counterclockwise. While striking a key, adjust CUTOFF FREQUENCY for sharp audio click. Check each key for double triggering by hitting it rapidly three times and then slowly depressing each key three times. If necessary, clean the center buss bar with ethyl alcohol on a cotton swab to ensure good contact.

5.22 LOUDNESS CONTOUR (ATTACK-DECAY-SUSTAIN)

Set CUTOFF FREQUENCY control fully clockwise, EMPHASIS control to 0 and AMOUNT OF CONTOUR control to 0. Turn on OSCILLATOR-1. Check ATTACK, DECAY and SUSTAIN controls of the LOUDNESS CONTOUR section. Hit a key repeatedly while slowly increasing the FILTER ATTACK time. Listen for volume changes at increasing length of attack with sudden fall. Return ATTACK control to 0 and check DECAY time in the same manner. This time listen for volume changes in sudden attack with slow decay. Return DECAY control to 0. Depress and hold a key and rotate SUSTAIN control fully clockwise. The pitch should rise and hold and with release of the key, the sound should diminish instantly. Set DECAY control to 1 second and turn DECAY switch on. The note should decay gradually after key is released. Turn DECAY switch off and insert a plug in the DECAY jack receptacle. The operation should be the same as having the DECAY switch on.

5.23 EXTERNAL LOUDNESS CONTROL UNIT

Set LOUDNESS ATTACK and DECAY controls to 0, SUSTAIN control to 10 and insert S-trigger plug. OSCILLATOR-1 should now be audible. Note the output level and apply +2.00 volts to LOUDNESS EXTERNAL CONTROL INPUT jack. The output should decrease by 10 ± 3 dB. Remove the external control voltage.

5.24 NOISE

Turn off OSCILLATOR-1. Noise level at HIGH MAIN OUTPUT jack with volume fully clockwise and S-trigger inserted should be 65dB maximum.

5.24.1 EXTERNAL LOUDNESS INPUT BALANCE (Second VCA Adjustment)

Apply a zero dB 1kHz square wave to the LOUDNESS EXT. input jack. Remove S-trigger plug and adjust the second VCA trim potentiometer for a null (Figure 5-3). Filter board level should be -60dB maximum.

5.25 CONTOUR GENERATOR BALANCE (First VCA Adjustment)

Insert S-trigger plug, set LOUDNESS SUSTAIN LEVEL at 10 and adjust first VCA balance trim potentiometer (Figure 5-3) for minimum output. Level should be -55dB maximum. Remove 1kHz signal from the LOUDNESS EXT. input jack.

5.26 EXTERNAL SIGNAL INPUT

Apply -30dB 1kHz sinewave to the INPUT EXT. SIGNAL jack. Turn on front panel MIXER switch and check VOLUME control operation. The OVERLOAD lamp should illuminate before any distortion is seen on the scope. Remove external signal and rotate MIXER VOLUME control to a point where noise level is maximum. Noise level should be less than -45dB. Turn off MIXER switch.

5.27 AUDIO NOISE GENERATOR

Turn on NOISE VOLUME MIXER switch and check both WHITE and PINK noise for quality and the absence of thumping or popping. Noise level should be -5 ± 3 dB. If not, adjust noise level trim potentiometer (right side of power supply board) so that both white and pink fall within specification. Turn off NOISE VOLUME MIXER switch.

5.28 GLIDE

Turn on OSCILLATOR-1 and alternately depress the lowest and highest keys. Pitch should change instantly. Turn on GLIDE switch and alternately depress lowest and highest keys again. Pitch should ascend and descend slowly. Check to see that the GLIDE control varies the speed and then turn the GLIDE switch off. Test the GLIDE jack to ensure it turns GLIDE on by inserting a plug and again

alternately depressing the lowest and highest keys. Remove the plug from the GLIDE jack.

5.29 KEYBOARD PITCH CONTACTS

Remove the S-trigger plug. While holding down the highest key, gently depress and release each other key one at a time. Listen for "squawks" and "chirps". If necessary, clean the front buss bar with ethyl alcohol to ensure good contact. Release highest key and slowly depress each key. Be sure pitch changes immediately without gliding. Re-insert S-trigger plug.

5.30 OSCILLATOR ADJUSTMENTS FOR BOARD

NOTE

Use a 1/8 inch (3.3mm) flat blade screw driver for all rear panel adjustments.

Touch up ± 10 volt adjustments to prepare for oscillator tuning. Adjust for exactly 10,000 volts, measured at the oscillator board.

Turn OSC 3 CONTROL switch on (up position). Check all three oscillators for proper WAVEFORMS and OCTAVE RANGING. Operate TUNE and FREQUENCY controls. TUNE control will only vary the pitch slightly, while the FREQUENCY controls will have a greater effect. Leave WAVEFORM switches at TRIANGLE (marked Δ), RANGE switches at 2' and MIXER VOLUME controls at 4. Turn off MIXER switches.

5.31 OSCILLATOR RANGE

Ensure the PITCH wheel is centered and the TUNE and FREQUENCY controls are at 0. Apply a -30dB, 3520Hz \pm 1Hz sinewave to the INPUT EXT. SIGNAL jack with CUTOFF FREQUENCY control at +4. Turn on EXTERNAL MIXER switch. Adjust level for -10dB at EXTERNAL INPUT VOLUME control. Turn on OSCILLATOR-1 MIXER switch, depress high "A" and hold key down. Adjust OSCILLATOR-1 RANGE trim potentiometer for zero beats. Turn off OSCILLATOR-1 and repeat procedure for OSCILLATOR-2 and OSCILLATOR-3. Turn off EXTERNAL MIXER switch.

5.32 OSCILLATOR 1 TUNING

Turn on OSCILLATOR-1 and A-440 switches. Hit low "A" and adjust OSCILLATOR-1 scale for zero beats. Recheck high "A" for 3520Hz and turn off A-440.

5.33 OSCILLATOR 2 AND 3 TRACKING

With OSCILLATOR-1 already on, turn on OSCILLATOR-2. Hit high "A" and adjust OSCILLATOR-2 FREQUENCY control for zero beats using a sawtooth waveform. Hit low "A" and adjust OSCILLATOR-2 scale for zero beats. Turn off OSCILLATOR-2 MIXER switch. Turn on OSCILLATOR-3 MIXER switch. Hit high "A" and adjust OSCILLATOR-3 FREQUENCY control for zero beats. Hit low "A" and adjust OSCILLATOR-3 SCALE trim potentiometer for zero beats. Turn off OSCILLATOR-3 MIXER switch.

5.34 OCTAVE ADJUST

Turn on A-440 switch and hit key low "A". Adjust TUNE control for zero beats against OSCILLATOR-1. Set OSCILLATOR-1 RANGE switch to the 16' position. Depress and hold high "A" while adjusting OCTAVE SCALE trim potentiometer for zero beats. Turn off switch A-440. This completes rough tuning at the oscillators.

5.35 RANGE OF TUNE, PITCH AND FREQUENCY ADJUST CONTROLS

Set controls listed below fully counterclockwise and test as follows:

Depress middle "C" and remember the pitch, then gradually turn the first TUNE control fully clockwise. Find how many semitones are required to descend nearest to the original pitch. Return each control to center after testing it.

TUNE control 4-6 Semitones
OSCILLATOR-2 FREQUENCY adjust. . . 14-17 Semitones
OSCILLATOR-3 FREQUENCY adjust. . . 14-17 Semitones
PITCH WHEEL PITCH adjust. 13-17 Semitones

5.36 OSCILLATOR 3 WIDE RANGE

Turn on OSCILLATOR-3 MIXER switch. Place OSC. 3 CONTROL switch in down (off) position. Assure that the keyboard has no effect on OSCILLATOR-3 pitch. Set WAVEFORM selector switch to sawtooth, RANGE switch to LO, and OSCILLATOR-3 FREQUENCY counterclockwise to minimum.

Listen to the audible clicks which should occur between two to five seconds apart. By operating the RANGE switch and the FREQUENCY control, check that the high end of the LO range overlaps the low end of the 32' range. Leave controls set for the lowest possible frequency and set WAVEFORM selector to square wave. Turn off OSCILLATOR-3 MIXER switch.

5.37 MODULATION OF OSCILLATOR

Place OSCILLATOR-1 switch in ON position and set RANGE control for 2' and WAVEFORM control for TRIANGLE Δ). Turn on OSCILLATOR MODULATION switch and rotate MOD control wheel fully up. The oscillator should change 13 to

23 semitones. Use keyboard to determine how many semitones it actually changes. Rotate MODULATION MIX control slowly clockwise. Listen for gradual change over to pure noise modulation. Try both PINK and WHITE noise. White noise should cause less rumbling.

Return MODULATION MIX potentiometer control to OSC. 3 position (counterclockwise). Set MOD control wheel all the way down. No modulation should be evident. Turn off OSCILLATOR-1 MIXER switch. Check OSCILLATOR-2 for 13 to 23 semitone range with MOD control wheel fully up and OSCILLATOR-3 WAVEFORM control on low square wave \square .

5.38 EXTERNAL CONTROL OF OSCILLATOR

Tune OSCILLATOR-1 to 440Hz. Apply +2.00 volts to OSCILLATOR INPUTS jack. At this time, frequency should rise to 1760 ± 150 Hz. Turn off OSCILLATOR-1 MIXER switch. Test OSCILLATOR-2 and OSCILLATOR-3 by setting RANGE control at 2' and WAVEFORM control to sawtooth for external control using the same procedure.

SECTION 6 KEYBOARD MAINTENANCE

6.1 CLEANING

Occasionally it will become necessary to clean and adjust the keyboard. The contacts, although gold plated, may become dirty, contaminated, or corroded. When contacts become poor, noises and erratic sounds may be generated while playing the instrument.

To service the keyboard, the bottom cover must be removed. This cover is held on with eight wood screws. If the keyboard compartment is found to be excessively dirty, it should be blown out with air. Avoid touching the buss bars or the spring

contacts with the fingers since hand oils and perspiration will cause corrosion. Under normal conditions, any dirt can be removed by using a solution of isopropyl alcohol on a cotton swab in the area of the problem keys. If alcohol does not cure the problem, clean the buss bar with a soft pencil eraser. For the most severe corrosion it may be necessary to rotate the buss bar 90 degrees.

CAUTION

Do not under any circumstances use abrasives or abrasive tools, since this will destroy the gold plating.

SECTION 7

REPLACEMENT PARTS LIST

7.1 ORDERING

The following lists specify parts available from Moog Music Inc., Customer Service Department, 2500 Walden Avenue, Buffalo, New York 14225, (716) 681-7242. Please specify the unit name, model, serial number, part description, electrical reference designator if applicable and part number when ordering. Parts may be ordered through the agencies listed on the back cover of this manual.

TABLE 7-1
GENERAL MECHANICAL REPLACEMENT PARTS LIST

PART NUMBER	DESCRIPTION	QTY	PART NUMBER	DESCRIPTION	QTY
997-041940-001	Back Cover	1	932-041179-001	Shipping Carton	1
918-043238-002	Buss Bar, Gold Plated	3	993-041181-001	S-Trig Plug	1
978-041204-001	Cabinet, Complete	1	964-042611-001	Black Key	18
978-943379-001	Cabinet, Top Trim Strip	1	964-041418-003	White Key, A	4
961-043266-001	"Flag Tool (For Connectors)	1	964-041418-004	White Key, B	4
997-041950-001	Front Panel	1	964-041418-005	White Key, C	3
997-041900-001	Keyboard, 44 Note	1	964-041418-006	White Key, D	3
917-043235-001	Key Contact, Gold Plated Spring	88	964-041418-007	White Key, E	3
915-041916-002	Knob, Large	2	964-041418-008	White Key, F	4
915-041917-001	Knob, Pointer	6	964-041418-009	White Key, G	4
915-041916-001	Knob, Small	19	964-041418-010	White Key, High C	1
957-041789-001	Power Cord, 120VAC	1			

TABLE 7-2
FRONT PANEL ASSEMBLY REPLACEMENT PARTS LIST

INDEX NO. OR REF DESIG	PART NUMBER	DESCRIPTION	QTY
R22, R34, R35, R41	852-512512-001	Resistor, 3.3K Ohm, $\pm 5\%$, 1/2W	4
R23, R24, R50	852-512243-001	Resistor, 24K Ohm, $\pm 5\%$, 1/2W	3
R25, R26, R27, R28	949-041130-001	Resistor, 1K Ohm, MATCHED SET, 4 Pieces	1
R29	853-424751-031	Resistor, 4.75K Ohm, $\pm 1\%$, 1/4W	1
R30, R36	852-512473-001	Resistor, 47K Ohm, $\pm 5\%$, 1/2W	2
R31, R37	852-512103-001	Resistor, 10K Ohm, $\pm 5\%$, 1/2W	2
R32, R38, R42	852-512752-001	Resistor, 7.5K Ohm, $\pm 5\%$, 1/2W	3
R33, R39, R43	852-512102-001	Resistor, 1K Ohm, $\pm 5\%$, 1/2W	3
R40, R44	852-512152-001	Resistor, 1.5K Ohm, $\pm 5\%$, 1/2W	2
R45, R46, R47, R49, R52	852-512333-001	Resistor, 33K Ohm, $\pm 5\%$, 1/2W	5
R48	852-512113-001	Resistor, 11K Ohm, $\pm 5\%$, 1/2W	1
R51	852-512104-001	Resistor, 100K Ohm, $\pm 5\%$, 1/2W	1
R53	852-512304-001	Resistor, 300K Ohm, $\pm 5\%$, 1/2W	1
R54	852-512154-001	Resistor, 150K Ohm, $\pm 5\%$, 1/2W	1
R55	852-512204-001	Resistor, 200K Ohm, $\pm 5\%$, 1/2W	1
	997-041925-001	Panel, Front, Mechanical Assembly	1

TABLE 7-3
FRONT PANEL AND LEFT HAND CONTROLLER REPLACEMENT PARTS LIST

INDEX NO. OR REF DESIG	PART NUMBER	DESCRIPTION	QTY
		Front Panel Controls consisting of:	
B1	906-041921-001	Socket, Lamp	1
B1 Lamp	939-041922-001	Lamp	1
B2	935-041919-001	Light Assembly, Pilot	1
J7	910-041306-004	Jack, Phone, 2 Circuit, Non-Shorting	1
J1401, J1402	910-041632-001	Jack, Phone, 0.206 Dia., 3 Conductor, Shorting	2
R1, R4, R5, R11	925-040294-004	Resistor, Rotary Pot, Linear, 5K Ohm	4
R2	925-040293-001	Resistor, Rotary Pot, No. 1 Taper, 5 Megohm	1
R3, R6, R7,			
R8, R10, R1403	925-040294-001	Resistor, Rotary Pot, Linear, 25K Ohm	6
R9, R12, R13,			
R15, R16	925-040294-005	Resistor, Rotary Pot, Audio, 1 Megohm	5
R14	925-040294-003	Resistor, Rotary Pot, Rev. Audio, 50K Ohm	1
R17 thru R21	925-040292-001	Resistor, Rotary Pot, Linear, 5K Ohm	5
R1402	925-040294-002	Resistor, Rotary Pot, Audio, 50K Ohm	1
S1, S2, S15,			
S16, S17	960-041761-002	Switch, Rocker, Orange, DPDT	5
S3 thru S14	960-041760-001	Switch, Rotary, 2 Pole, 6 Position	12
S18, S19	960-041761-001	Switch, Rocker, Blue, DPDT	2
S20	960-041755-001	Switch, Rocker, Black, DPDT	1
S1401, S1402	960-041761-003	Switch, Rocker, White, DPDT	2
	964-040865-001	Wheel, Left Hand Controller	2
	909-040938-001	Pin, Dowel, 0.06 inch x 0.5 inch	4
	962-041179-001	Detent	1
	961-041178-001	Detent Spring	1
	903-040486-062	Screw, Allen Set 6-32 x 0.38 inch	2

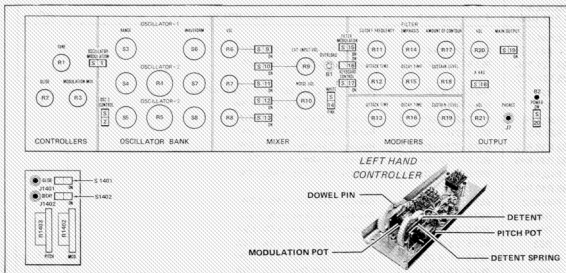

FIGURE 7-1 FRONT PANEL CONTROL DIAGRAM

TABLE 7-4
NEW OSCILLATOR PRINTED CIRCUIT BOARD ASSEMBLY BOARD 1
REPLACEMENT PARTS LIST (SERIAL NUMBERS 10175 AND ABOVE)

INDEX NO. OR REF INDEX	PART NUMBER	DESCRIPTION	QTY
	996-041928-002	Printed Circuit Board Assembly consisting of:	
C1,C2,C37	946-040231-005	Capacitor, Tantalum, 5.6uf, $\pm 10\%$, 35V	3
C3	946-040231-006	Capacitor, Tantalum, 27uf, $\pm 10\%$, 20V	1
C4,C9,C15, C20,C26,C31	947-042020-101	Capacitor, Ceramic Disc, 100Pf, $\pm 10\%$, 50V	6
C5,C10,C11, C14,C16,C21, C22,C25,C27, C32,C33,C36	947-040200-103	Capacitor, Ceramic Disc, 0.01uf, $\pm 10\%$, 50V	12
C6,C17,C28	946-040231-001	Capacitor, Tantalum, 1.5uf, $\pm 10\%$, 20V	3
C7,C18,C29	946-041508-102	Capacitor, Polycarbonate, 0.001uf, $\pm 10\%$, 50V	3
C8,C19,C30	946-041978-102	Capacitor, Polyester, 0.001uf, $\pm 10\%$, 50V	3
C12,C23,C34	947-042020-180	Capacitor, Ceramic Disc, 18Pf, $\pm 10\%$, 50V	3
C13,C24,C35	947-042020-501	Capacitor, Ceramic Disc, 500Pf, $\pm 10\%$, 50V	3
CR1 thru CR6	919-041075-001	Diode, 1N4148 or Alternate 1N914	6
IC1,IC3,IC4, IC9,IC14	991-041102-001	Integrated Circuit, Dual Operational Amplifier, MC1458CP-1	5
IC2	991-041101-001	Integrated Circuit, Operational Amplifier, 741	1
IC5,IC10,IC15	991-041082-001	Integrated Circuit, 726	3
IC6,IC7,IC11, IC12,IC16,IC17	991-042386-001	Integrated Circuit, Operational Amplifier, TL081	6
IC8,IC13,IC18	991-042388-001	Integrated Circuit, LM393	3
N1	949-042330-001	Resistor Network, Primary Summer	1
N2 thru N4	949-042331-001	Resistor Network, Secondary Summer	3
N5 thru N7	949-042332-001	Resistor Network, Oscillator	3
Q1	991-041052-001	Transistor, PNP, 2N3906	1
Q2	991-041275-001	Transistor, N Channel, FET, E101	1
Q3,Q5,Q6, Q10,Q11,Q15 thru Q20	991-041051-001	Transistor, NPN, 2N3904	11
Q4,Q9,Q14	991-041055-001	Transistor, Switching, FET, E112	3
R3	853-421244-031	Resistor, 1.24 Megohm, $\pm 1\%$, 1/4W	1
R7	852-312223-001	Resistor, 22K Ohm, $\pm 5\%$, 1/4W	1
R8,R11	852-312472-001	Resistor, 4.7K Ohm, $\pm 5\%$, 1/4W	2
R9,R10	853-424991-031	Resistor, 4.99K Ohm, $\pm 1\%$, 1/4W	2
R14,R16,R31, R52,R55,R71, R90,R91,R109	925-042389-002	Resistor, Trim Pot, 10K	9
R18,R57,R92	925-042390-001	Resistor, Trim Pot, 5K	3
R22,R62,R100	852-312153-001	Resistor, 15K Ohm, $\pm 5\%$, 1/4W	3
R23,R63,R101	853-422321-031	Resistor, 2.32K Ohm, $\pm 1\%$, 1/4W	3
R24,R64,R102	853-421000-031	Resistor, 100 Ohm, $\pm 1\%$, 1/4W	3
R25,R26,R42, R65,R66,R82, R103,R104, R120	853-421002-031	Resistor, 10K Ohm, $\pm 1\%$, 1/4W	9

TABLE 7-4
NEW OSCILLATOR PRINTED CIRCUIT BOARD ASSEMBLY BOARD 1
REPLACEMENT PARTS LIST (SERIAL NUMBERS 10175 AND ABOVE) (Continued)

INDEX NO. OR REF DESIG	PART NUMBER	DESCRIPTION	QTY
R27, R67, R106	853-424992-031	Resistor, 49.9K Ohm, $\pm 1\%$, 1/4W, Metal Film	3
R28, R32, R61, R68, R72, R106, R110	852-312104-001	Resistor, 100K Ohm, $\pm 5\%$, 1/4W	7
R29, R69, R107	852-312102-001	Resistor, 1K Ohm, $\pm 5\%$, 1/4W	3
R30, R70, R108	853-422004-031	Resistor, 2.0 Megohm, $\pm 1\%$, 1/4W	3
R31, R71, R109	925-042389-001	Resistor, Trim Pot, 5K Ohm	3
R33, R73, R111	852-312202-001	Resistor, 2K Ohm, $\pm 5\%$, 1/4W	3
R34, R60, R74, R112	852-312105-001	Resistor, 1 Megohm, $\pm 5\%$, 1/4W	4
R35, R75, R113	852-312101-001	Resistor, 100 Ohm, $\pm 5\%$, 1/4W	3
R45, R47, R85, R87, R126, R127	853-421003-031	Resistor, 100K Ohm, $\pm 1\%$, 1/4W	6
R46, R86, R125	852-312225-001	Resistor, 2.2 Megohm, $\pm 5\%$, 1/4W	3
R48, R88, R131	852-312512-001	Resistor, 5.1K Ohm, $\pm 5\%$, 1/4W	3
R49, R89, R132	852-312272-001	Resistor, 2.7K Ohm, $\pm 5\%$, 1/4W	3
R123	852-312331-001	Resistor, 330 Ohm, $\pm 5\%$, 1/4W	1
R124	852-312222-001	Resistor, 2.2K Ohm, $\pm 5\%$, 1/4W	1
R128	852-312394-001	Resistor, 390K Ohm, $\pm 5\%$, 1/4W	1
R129	852-312683-001	Resistor, 68K Ohm, $\pm 5\%$, 1/4W	1
R130	852-312333-001	Resistor, 33K Ohm, $\pm 5\%$, 1/4W	1
R133	852-312752-001	Resistor, 7.5K Ohm, $\pm 5\%$, 1/4W	1
R134	852-312183-001	Resistor, 18K Ohm, $\pm 5\%$, 1/4W	1
R135 thru R137	852-312224-001	Resistor, 220K Ohm, $\pm 5\%$, 1/4W	3
	906-040377-001	Socket, Integrated Circuit, 10 Pin, TO-5	3
		Selected for oscillator tuning. Value may also be 75K or 100K $\pm 1\%$, 1/4W, Metal Film.	

TABLE 7-5
 OLD OSCILLATOR PRINTED CIRCUIT BOARD ASSEMBLY BOARD 1
 REPLACEMENT PARTS LIST (SERIAL NUMBERS BELOW 10175)

INDEX NO. OR REF DESIG	PART NUMBER	DESCRIPTION	QTY
	996-041928-001	Printed Circuit Board Assembly consisting of:	
C1,C6,C8 C2 thru C5, C7,C9	946-042021-103	Capacitor, 0.01uf, Polystyrene, $\pm 2\%$, 35V	3
C10	945-040209-005	Capacitor, Electrolytic, 2.2uf, +75/-10%, 50V	1
C11,C12	946-040231-005	Capacitor, Tantalum, 5.6uf, $\pm 10\%$, 35V	2
C13	946-040231-006	Capacitor, Tantalum, 27uf, $\pm 10\%$, 35V	1
C14	946-040190-124	Capacitor, Polyester, 0.12uf, $\pm 10\%$, 50V	1
IC1,IC3 thru IC6,IC8 thru IC10	991-041101-001	Integrated Circuit, 741	8
IC2,IC7	991-041104-001	Integrated Circuit, 3046	2
Q1 thru Q4,Q12 thru Q15,Q22, Q24 thru Q27, Q30,Q36 thru Q38	991-042017-001	Transistor, 2N3392	17
Q5,Q6,Q16, Q17,Q28,Q29	991-041052-001	Transistor, 2N3906	6
Q7,Q18,Q31 Q8,Q9,Q11, Q19,Q20,Q23, Q32,Q33,Q35	991-041060-001	Transistor, 2N4058	9
Q10,Q21,Q34 R1,R40,R53, R98,R111,R152	991-041063-001	Transistor, 2N4402	3
R2,R112,R153	852-512433-001	Resistor, 43K Ohm, $\pm 5\%$, 1/2W	6
R3,R24,R30, R55,R75,R83, R113,R132, R139	852-512914-001	Resistor, 910K Ohm, $\pm 5\%$, 1/2W	3
R4,R16,R56, R67,R114,R124	853-421072-031	Resistor, 10.7K Ohm, $\pm 1\%$, 1/4W	9
R5,R46,R57, R103,R115, R159	853-423322-031	Resistor, 33.2K Ohm, $\pm 1\%$, 1/4W	6
R6,R58,R116 R7,R18,R47, R104,R154, R160	852-512562-001	Resistor, 5.6K Ohm, $\pm 5\%$, 1/2W	6
R8,R60,R107	852-512560-001	Resistor, 56 Ohm, $\pm 5\%$, 1/2W	3
R9,R51,R100, R156,R171	925-040279-003	Resistor, Trim Pot, 100 Ohm	3
	852-512330-001	Resistor, 33 Ohm, $\pm 5\%$, 1/2W	5

TABLE 7-5
OLD OSCILLATOR PRINTED CIRCUIT BOARD ASSEMBLY BOARD 1
REPLACEMENT PARTS LIST (SERIAL NUMBERS BELOW 10175) (Continued)

INDEX NO. OR REF DESIG	PART NUMBER	DESCRIPTION	QTY
R10, R19, R26, R49, R70, R77, R79, R86, R94, R117, R118, R127, R134, R135, R161	852-512102-001	Resistor, 1K Ohm, $\pm 5\%$, 1/2W	15
R11, R62, R109	925-040279-004	Resistor, Trim Pot, 1K Ohm	3
R12, R96, R110 R13, R64, R121, R166	853-421503-031	Resistor, 150K Ohm, $\pm 1\%$, 1/4W	3
R14, R65, R122 R15, R66, R123, R165	852-512622-001	Resistor, 6.2K Ohm, $\pm 5\%$, 1/2W	4
R17, R31, R68, R84, R125, R140	852-512154-001	Resistor, 150K Ohm, $\pm 5\%$, 1/2W	3
R20, R71, R119 R21, R88, R120 R22, R33, R73, R89, R130, R145, R167	852-512103-001	Resistor, 10K Ohm, $\pm 5\%$, 1/2W	6
R23, R74, R131 R25, R76, R133, R170	924-040183-001	Resistor, 1K Ohm, $\pm 3\%$, 1W, Temperature Compensating	3
R27, R80, R129 R28, R81, R137 R29, R82, R138, R173, R177	852-512564-001	Resistor, 560K Ohm, $\pm 5\%$, 1/2W	3
R32, R38, R63, R72, R136 R143, R144	852-512472-001	Resistor, 4.7K Ohm, $\pm 5\%$, 1/2W	7
R34, R90, R146 R35, R39, R91, R97, R147, R151	852-512822-001	Resistor, 8.2K Ohm, $\pm 5\%$, 1/2W	3
R36, R92, R148 R37, R61, R108 R41, R54, R112	853-421502-031	Resistor, 15K Ohm, $\pm 1\%$, 1/4W	4
R42, R93, R142 R43, R52, R179 R44, R101, R157, R182	949-041121-001	Resistor, 51.1K Ohm, $\pm 1\%$, 1/4W (MATCHED SET of 3)	1
R45, R102, R158 R48, R85, R126 R50, R59, R149	852-512751-001	Resistor, 750 Ohm, $\pm 5\%$, 1/2W	3
	853-421002-031	Resistor, 10K Ohm, $\pm 1\%$, 1/4W	5
	852-512104-001	Resistor, 100K Ohm, $\pm 5\%$, 1/2W	6
	852-512272-001	Resistor, 2.7K Ohm, $\pm 5\%$, 1/2W	3
	853-421182-031	Resistor, 11.8K Ohm, $\pm 1\%$, 1/4W	3
	852-512911-001	Resistor, 910 Ohm, $\pm 5\%$, 1/2W	3
	852-512164-001	Resistor, 160K Ohm, $\pm 5\%$, 1/2W	3
	949-041122-001	Resistor, 15K Ohm, $\pm 1\%$, 1/4W, (MATCHED SET of 3)	1
	852-512394-001	Resistor, 390K Ohm, $\pm 5\%$, 1/2W	4
	852-512122-001	Resistor, 1.2K Ohm, $\pm 5\%$, 1/2W	3
	852-512123-001	Resistor, 12K Ohm, $\pm 5\%$, 1/2W	3
	852-512393-001	Resistor, 39K Ohm, $\pm 5\%$, 1/2W	3

TABLE 7-5
OLD OSCILLATOR PRINTED CIRCUIT BOARD ASSEMBLY BOARD 1
REPLACEMENT PARTS LIST (SERIAL NUMBERS BELOW 10175) (Continued)

INDEX NO. OR REF DESIG	PART NUMBER	DESCRIPTION	QTY
R69,R105,			
R141,R180	852-512153-001	Resistor, 15K Ohm, $\pm 5\%$, 1/2W	4
R78,R106,R128	949-041129-001	Resistance Capacitance Network	1
R87	852-512913-001	Resistor, 91K Ohm, $\pm 5\%$, 1/2W	1
R95	852-512224-001	Resistor, 220K Ohm, $\pm 5\%$, 1/2W	1
R99	852-512911-001	Resistor, 910 Ohm, $\pm 5\%$, 1/2W	1
R148	852-512272-001	Resistor, 2.7K Ohm, $\pm 5\%$, 1/2W	1
R150	853-421001-031	Resistor, 1K Ohm, $\pm 1\%$, 1/4W	1
R155,R162	853-423011-031	Resistor, 3.01K Ohm, $\pm 1\%$, 1/4W	2
R163	852-512333-001	Resistor, 33K Ohm, $\pm 5\%$, 1/2W	1
R164	852-512331-001	Resistor, 330 Ohm, $\pm 5\%$, 1/2W	1
R168	925-040279-002	Resistor, Trim Pot, 25 Ohm	1
R169	853-426818-031	Resistor, 68.1 Ohm, $\pm 1\%$, 1/4W	1
R172	852-512752-001	Resistor, 7.5K Ohm, $\pm 5\%$, 1/2W	1
R174	852-512392-001	Resistor, 3.9K Ohm, $\pm 5\%$, 1/2W	1
R175	852-512683-001	Resistor, 68K Ohm, $\pm 5\%$, 1/2W	1
R176	852-512183-001	Resistor, 18K Ohm, $\pm 5\%$, 1/2W	1
R178	852-512512-001	Resistor, 5.1K Ohm, $\pm 5\%$, 1/2W	1
R181	852-512513-001	Resistor, 51K Ohm, $\pm 5\%$, 1/2W	1
	903-040307-007	Socket, Integrated Circuit, 7 Pin	4

TABLE 7-6
CONTOUR GENERATOR PRINTED CIRCUIT BOARD ASSEMBLY BOARD 2
REPLACEMENT PARTS LIST

INDEX NO. OR REF DESIG	PART NUMBER	DESCRIPTION	QTY
	996-041938-001	Printed Circuit Board Assembly consisting of:	
C1,C4,C13	946-041978-103	Capacitor, Polyester, 0.01uf, $\pm 10\%$, 50V	3
C2,C5	945-040209-008	Capacitor, Electrolytic, 10uf, +50/-10%, 50V	2
C3,C7	946-041978-104	Capacitor, Polyester, 0.1uf, $\pm 10\%$, 50V	2
C6	946-040226-105	Capacitor, Polyester, 1uf, $\pm 10\%$, 63V	1
C8	947-042020-101	Capacitor, Ceramic Disc, 100Pf, $\pm 10\%$, 50V	1
C9	946-040190-334	Capacitor, Polyester, 0.33uf, $\pm 10\%$, 50V	1
C11	947-042020-470	Capacitor, Ceramic Disc, 47Pf, $\pm 10\%$, 50V	1
C12	947-042020-501	Capacitor, Ceramic Disc, 500Pf, $\pm 10\%$, 50V	1
CR1,CR3,CR6, CR8,CR10	919-041074-001	Diode, 1N34A	5
CR2,CR4,CR5, CR7,CR9	919-042019-001	Diode, 1N4004	5
Q1 thru Q4,Q6, Q7,Q15,Q17, Q18,Q20,Q22,			

TABLE 7-6
 CONTOUR GENERATOR PRINTED CIRCUIT BOARD ASSEMBLY BOARD 2
 REPLACEMENT PARTS LIST (Continued)

INDEX NO. OR REF DESIG	PART NUMBER	DESCRIPTION	QTY
Q25	991-042017-001	Transistor, 2N3392	12
Q5,Q8,Q16, Q19,Q21	991-041062-001	Transistor, T1S93, Alternate 2N3906	5
Q9,Q11	991-041128-001	Transistor, T1S93, Alternate 2N3906, Matched with T1S92, Alternate 2N3904 (furnished as a set)	1
Q10,Q13	991-041064-001	Transistor, 2N4303	2
Q12,Q26	991-041059-001	Transistor, 2N3415, Alternate 2N3392	2
Q14,Q23	991-041124-001	Transistor, 2N3392, Matched with 2N3392, (furnished as a set)	1
Q24	991-041060-001	Transistor, 2N4058	1
R1	853-425900-031	Resistor, 590 Ohm, $\pm 1\%$, 1/4W	1
R2,R61,R62	852-512331-001	Resistor, 330 Ohm, $\pm 5\%$, 1/2W	3
R3,R4,R8,R16, R19,R21,R26, R28,R30,R32, R35 thru R39, R43,R48	852-512103-001	Resistor, 10K Ohm, $\pm 5\%$, 1/2W	17
R5,R23,R40	852-512332-001	Resistor, 3.3K Ohm, $\pm 5\%$, 1/2W	3
R6,R15,R41, R50,R51	852-512561-001	Resistor, 560 Ohm, $\pm 5\%$, 1/2W	5
R7,R11,R42, R46,R60	852-512101-001	Resistor, 100 Ohm, $\pm 5\%$, 1/2W	5
R9,R13,R44, R47,R57	852-512472-001	Resistor, 4.7K Ohm, $\pm 5\%$, 1/2W	5
R10,R45	852-512273-001	Resistor, 27K Ohm, $\pm 5\%$, 1/2W	2
R12	852-512302-001	Resistor, 3K Ohm, $\pm 5\%$, 1/2W	1
R14,R56	852-512333-001	Resistor, 33K Ohm, $\pm 5\%$, 1/2W	2
R17	852-512154-001	Resistor, 150K Ohm, $\pm 5\%$, 1/2W	1
R18,R59	852-512392-001	Resistor, 3.9K Ohm, $\pm 5\%$, 1/2W	2
R20,R22	853-421001-031	Resistor, 1K Ohm, $\pm 1\%$, 1/4W	2
R24	852-512682-001	Resistor, 6.8K Ohm, $\pm 5\%$, 1/2W	1
R25	852-512162-001	Resistor, 1K Ohm, $\pm 5\%$, 1/2W	1
R27,R29	853-421692-031	Resistor, 16.9K Ohm, $\pm 1\%$, 1/4W	2
R31	852-513226-001	Resistor, 22 Megohm, $\pm 10\%$, 1/2W	1
R33	852-512562-001	Resistor, 5.6K Ohm, $\pm 5\%$, 1/2W	1
R34,R60,R64	852-512104-001	Resistor, 100K Ohm, $\pm 5\%$, 1/2W	3
R49	852-512221-001	Resistor, 220 Ohm, $\pm 5\%$, 1/2W	1
R52	852-512433-001	Resistor, 43K Ohm, $\pm 5\%$, 1/2W	1
R53	852-513475-001	Resistor, 4.7 Megohm, $\pm 10\%$, 1/2W	1
R54	852-512152-001	Resistor, 15K Ohm, $\pm 5\%$, 1/2W	1
R55	852-512473-001	Resistor, 47K Ohm, $\pm 5\%$, 1/2W	1
R58	852-512622-001	Resistor, 6.2K Ohm, $\pm 5\%$, 1/2W	1
R63	852-512150-001	Resistor, 15 Ohm, $\pm 5\%$, 1/2W	1
R65	852-512152-001	Resistor, 5.1K Ohm, $\pm 5\%$, 1/2W	1

TABLE 7-7
POWER SUPPLY PRINTED CIRCUIT BOARD ASSEMBLY BOARD 3
REPLACEMENT PARTS LIST

INDEX NO. OR REF DESIG	PART NUMBER	DESCRIPTION	QTY
	996-041931-001	Printed Circuit Board Assembly consisting of:	
C1,C4,C8, C19,C20	945-040209-005	Capacitor, Electrolytic, 2.2uf, +75/-10%, 50V	5
C2	946-041978-333	Capacitor, Polyester, 0.033uf, ± 10%, 50V	1
C3	946-042280-124	Capacitor, Polyester, 0.12uf, ± 10%, 50V	1
C5,C6,C11,C23	947-042020-101	Capacitor, Ceramic Disc, 100Pf, ± 10%, 50V	4
C7,C18,C22	946-042280-154	Capacitor, Polyester, 0.15uf, ± 10%, 50V	3
C10,C13,C27	946-041978-104	Capacitor, Polyester, 0.1uf, ± 10%, 50V	3
C12	946-040231-005	Capacitor, Polyester, 5.6uf, ± 10%, 50V	1
C14	946-041978-223	Capacitor, Polyester, 0.022uf, ± 10%, 50V	1
C15	947-042020-221	Capacitor, Ceramic Disc, 220Pf, ± 10%, 50V	1
C21	945-040209-010	Capacitor, Electrolytic, 470uf, +50/-10%, 50V	1
C24,C26	945-040209-009	Capacitor, Electrolytic, 100uf, +50/-10%, 25V	2
C25,C28	945-040209-008	Capacitor, Electrolytic, 10uf, +50/-10%, 50V	2
C29,C30	945-040020-470	Capacitor, Ceramic Disc, 47Pf, ± 10%, 50V	2
CR1,CR2	919-041081-001	Diode, 1N458	2
CR3	919-041078-001	Diode, 1N821	1
Q1	991-041057-001	Transistor, MPS-U55	1
Q2,Q5,Q10	991-041061-001	Transistor, T1S92	3
Q3,Q4,Q6, Q12,Q17,Q18	991-042017-001	Transistor, 2N3392	6
Q7,Q8,Q9	991-041060-001	Transistor, 2N4058	3
Q11,Q16,Q19	991-041062-001	Transistor, T1S93	3
Q13,Q14	991-041126-001	Transistor, T1S97	2
Q15	991-041062-001	Transistor, 2N3392 Selected	1
Q19	991-041062-001	Transistor, T1S93, Alternate 2N3906	1
Q20	991-041056-001	Transistor, MPS-U05	1
R1	852-512121-001	Resistor, 120 Ohm, ± 5%, 1/2W	1
R2,R12,R16, R24,R30	852-512103-001	Resistor, 10K Ohm, ± 5%, 1/2W	5
R3,R8,R19	852-512332-001	Resistor, 3.3K Ohm, ± 5%, 1/2W	3
R4,R10,R11, R20,R48,R61, R63	852-512821-001	Resistor, 820 Ohm, ± 5%, 1/2W	7
R5,R14	852-512123-001	Resistor, 12K Ohm, ± 5%, 1/2W	2
R6,R7	852-512564-001	Resistor, 560K Ohm, ± 5%, 1/2W	2
R9	852-512471-001	Resistor, 470 Ohm, ± 5%, 1/2W	1
R13	852-512221-001	Resistor, 220 Ohm, ± 5%, 1/2W	1
R15	852-512392-001	Resistor, 3.9K Ohm, ± 5%, 1/2W	1
R17,R59	852-512104-001	Resistor, 100K Ohm, ± 5%, 1/2W	2
R18,R55	852-512330-001	Resistor, 33 Ohm, ± 5%, 1/2W	2
R21	925-040279-002	Resistor, Trim Pot, 25 Ohm	1
R23,R28	853-513225-001	Resistor, 2.2 Megohm, ± 10%, 1/2W	2

TABLE 7-7
POWER SUPPLY PRINTED CIRCUIT BOARD ASSEMBLY BOARD 3
REPLACEMENT PARTS LIST (Continued)

INDEX NO. OR REF DESIG	PART NUMBER	DESCRIPTION	QTY
R26	925-040279-005	Resistor, Trim Pot, 2.5K Ohm	1
R27,R51	852-512301-001	Resistor, 300 Ohm, $\pm 5\%$, 1/2W	2
R29	852-513475-001	Resistor, 4.7 Megohm, $\pm 10\%$, 1/2W	1
R31	852-512561-001	Resistor, 560 Ohm, $\pm 5\%$, 1/2W	1
R32,R33	852-512047-001	Resistor, 4.7 Ohm, $\pm 5\%$, 1/2W	2
R34	853-423010-031	Resistor, 301 Ohm, $\pm 1\%$, 1/4W	1
R35,R36,			
R38,R56	852-512391-001	Resistor, 390 Ohm, $\pm 5\%$, 1/2W	4
R39,R44	853-425110-031	Resistor, 511 Ohm, $\pm 1\%$, 1/4W	2
R40,R41,			
R45,R66	852-512100-001	Resistor, 10 Ohm, $\pm 5\%$, 1/2W	4
R42,R50	852-512622-001	Resistor, 6.2 Ohm, $\pm 5\%$, 1/2W	2
R43	852-512911-001	Resistor, 910 Ohm, $\pm 5\%$, 1/2W	1
R47	852-512753-001	Resistor, 75K Ohm, $\pm 5\%$, 1/2W	1
R49	852-512122-001	Resistor, 1.2K Ohm, $\pm 5\%$, 1/2W	1
R52,R65	853-429090-031	Resistor, 909 Ohm, $\pm 1\%$, 1/4W	2
R53	852-512243-001	Resistor, 24K Ohm, $\pm 5\%$, 1/2W	1
R54, R62, R64	852-512433-001	Resistor, 43K Ohm, $\pm 5\%$, 1/2W	3
R55	852-512330-001	Resistor, 33 Ohm, $\pm 5\%$, 1/2W	1
R57	852-512102-001	Resistor, 1K Ohm, $\pm 5\%$, 1/2W	1
R58	925-040279-001	Resistor, Trim Pot, 10 Ohm	1
R60	852-512913-001	Resistor, 91K Ohm, $\pm 5\%$, 1/2W	1
R67	852-512474-001	Resistor, 470K Ohm, $\pm 5\%$, 1/2W	1
	801-023221-000	Nut, 4-40	2
	806-023039-006	Screw, Pan Hd., 4-40 x 3/8 in.	2
	904-040495-015	Washer, Lock, No. 4	2
	905-040498-004	Rivet, Pop, 1/8 in, Dia.	2
	967-041195-001	Heat Sink	2

TABLE 7-8
 FILTER PRINTED CIRCUIT BOARD ASSEMBLY BOARD 4
 REPLACEMENT PARTS LIST

INDEX NO. OR REF DESIG	PART NUMBER	DESCRIPTION	QTY
		Printed Circuit Board Assembly consisting of:	
C1,C5	996-041395-001	Capacitor, Polyester, 0.22uf, ± 10%, 50V	2
C2,C10,C27	946-040209-008	Capacitor, Aluminum Electrolytic, 10uf, +50/-10%, 50V	3
C3,C7,C11,C16	946-041978-683	Capacitor, Polyester, 0.068uf, ± 10%, 50V	4
C4,C15,C24,C26	945-040209-003	Capacitor, Aluminum Electrolytic, 220uf, +50/-10%, 6V	4
C6	946-040190-334	Capacitor, Polyester, 0.33uf, ± 10%, 50V	1
C8,C12,C23	946-041978-104	Capacitor, Polyester, 0.1uf, ± 10%, 50V	3
C9	945-040209-009	Capacitor, Aluminum Electrolytic, 100uf, +50/-10%, 25V	1
C13,C19	946-042021-303	Capacitor, Polystyrene, 0.030uf, ± 2.5%, 35V	2
C14	945-040209-006	Capacitor, Aluminum Electrolytic, 0.47uf, +75/-10%, 50V	1
C17,C25	946-042021-xxx	Capacitor, Polystyrene, 600-1200Pf, Selected	2
C18,C22	945-042020-101	Capacitor, Ceramic Disc, 100Pf, ± 10%, 50V	2
C20	946-040226-105	Capacitor, Polyester, 1uf, ± 10%, 63V	1
C21	947-042020-100	Capacitor, Ceramic Disc, 10Pf, ± 10%, 50V	1
CR1,CR2	919-041081-001	Diode, 1N458A	2
CR3,CR4	919-041075-001	Diode, 1N4148	2
Q1,Q9,Q12, Q17,Q33	991-041060-001	Transistor, 2N4058	5
Q2,Q3,Q10, Q11,Q18 thru Q24	991-041126-001	Transistor, T1S97S	12
Q4,Q25	991-042017-001	Transistor, 2N3392	2
Q5,Q7	991-041127-001	Transistor, T1S97, Matched Pair	1
Q6,Q8	991-041127-001	Transistor, T1S97, Matched Pair	1
Q13,Q14	991-041127-001	Transistor, T1S97, Matched Pair	1
Q15,Q16	991-041127-001	Transistor, T1S97, Matched Pair	1
Q26,Q28	991-041123-001	Transistor, T1S93, Alternate 3906, Matched with T1S92, Alternate 3904	1
Q27,Q32	991-041127-001	Transistor, T1S97, Matched Pair	1
Q29,Q30	991-041127-001	Transistor, T1S97, Matched Pair	1
Q31	991-041062-001	Transistor, T1S93, Alternate 3906	1
Q34	991-041061-001	Transistor, T1S92, Alternate 3904	1
R1	852-512xxx-001	Resistor, 2.2 Megohm, Selected	1
R2	852-512823-001	Resistor, 82K Ohm, ± 5%, 1/2W	1
R3,R26,R35, R62,R63,R75, R77,R78	852-512102-001	Resistor, 1K Ohm, ± 5%, 1/2W	8
R4	852-512221-001	Resistor, 220 Ohm, ± 5%, 1/2W	1
R5	852-512223-001	Resistor, 22K Ohm, ± 5%, 1/2W	1
R6,R72	852-512470-001	Resistor, 47 Ohm, ± 5%, 1/2W	2
R7	852-512181-001	Resistor, 180 Ohm, ± 5%, 1/2W	1
R8,R28	852-512082-001	Resistor, 8.2 Ohm, ± 5%, 1/2W	2
R9	852-512620-001	Resistor, 62 Ohm, ± 5%, 1/2W	1
R10,R13,R22	852-512121-001	Resistor, 120 Ohm, ± 5%, 1/2W	3
R11,R16,R32, R41,R52	852-512151-001	Resistor, 150 Ohm, ± 5%, 1/2W	5

TABLE 7-8
 FILTER PRINTED CIRCUIT BOARD ASSEMBLY BOARD 4
 REPLACEMENT PARTS LIST (Continued)

INDEX NO. OR REF DESIG	PART NUMBER	DESCRIPTION	QTY
R12	925-040279-003	Resistor, Trim Pot, 100 Ohm	1
R14	925-040279-002	Resistor, Trim Pot, 25 Ohm	1
R15	853-423321-031	Resistor, 3.32K Ohm, $\pm 1\%$, 1/2W	1
R17, R71	853-424751-031	Resistor, 4.75K Ohm, $\pm 1\%$, 1/2W	2
R18, R21, R45,			
R76	852-512331-001	Resistor, 330 Ohm, $\pm 5\%$, 1/2W	4
R19, R23, R64	852-512101-001	Resistor, 100 Ohm, $\pm 5\%$, 1/2W	3
R20, R56, R66	852-512104-001	Resistor, 100K Ohm, $\pm 5\%$, 1/2W	3
R24	852-512224-001	Resistor, 220K Ohm, $\pm 5\%$, 1/2W	1
R25	853-427502-031	Resistor, 75K Ohm, $\pm 1\%$, 1/4W	1
R27	852-512474-001	Resistor, 470K Ohm, $\pm 5\%$, 1/2W	1
R29, R30, R60	852-512681-001	Resistor, 680 Ohm, $\pm 5\%$, 1/2W	3
R31, R38, R74	852-512473-001	Resistor, 47K Ohm, $\pm 5\%$, 1/2W	3
R33, R54	852-512471-001	Resistor, 470 Ohm, $\pm 5\%$, 1/2W	2
R34	852-512821-001	Resistor, 820 Ohm, $\pm 5\%$, 1/2W	1
R36	852-512511-001	Resistor, 510 Ohm, $\pm 5\%$, 1/2W	1
R37	852-512682-001	Resistor, 6.8K Ohm, $\pm 5\%$, 1/2W	1
R39	925-040279-006	Resistor, Trim Pot, 10K Ohm	1
R40	852-512222-001	Resistor, 2.2K Ohm, $\pm 5\%$, 1/2W	1
R41, R52	852-512151-001	Resistor, 150 Ohm, $\pm 5\%$, 1/2W	2
R42	852-512332-001	Resistor, 3.3K Ohm, $\pm 5\%$, 1/2W	1
R43	852-512274-001	Resistor, 270K Ohm, $\pm 5\%$, 1/2W	1
R44, R58	852-512154-001	Resistor, 150K Ohm, $\pm 5\%$, 1/2W	2
R46, R59	852-512683-001	Resistor, 68K Ohm, $\pm 5\%$, 1/2W	2
R47	853-423322-031	Resistor, 33.2K Ohm, $\pm 1\%$, 1/4W	1
R48	852-512684-001	Resistor, 680K Ohm, $\pm 5\%$, 1/4W	1
R49	925-040280-001	Resistor, Trim Pot, 500 Ohm	1
R50	852-512823-001	Resistor, 82K Ohm, $\pm 5\%$, 1/2W	1
R51	852-512333-001	Resistor, 33K Ohm, $\pm 5\%$, 1/2W	1
R53, R57, R69	852-512103-001	Resistor, 10K Ohm, $\pm 5\%$, 1/2W	3
R55	853-421692-031	Resistor, 16.9K Ohm, $\pm 1\%$, 1/4W	1
R59	852-512683-001	Resistor, 68K Ohm, $\pm 5\%$, 1/2W	1
R61	852-512204-001	Resistor, 200K Ohm, $\pm 5\%$, 1/2W	1
R65	852-512273-001	Resistor, 27K Ohm, $\pm 5\%$, 1/2W	1
R67	852-512201-001	Resistor, 200 Ohm, $\pm 5\%$, 1/2W	1
R68, R73	925-040279-004	Resistor, Trim Pot, 1K Ohm	2
R70	852-512182-001	Resistor, 1.8K Ohm, $\pm 5\%$, 1/2W	1

TABLE 7-9
RECTIFIER AND FILTER PRINTED CIRCUIT BOARD ASSEMBLY BOARD 5
REPLACEMENT PARTS LIST

INDEX NO. OR REF DESIG	PART NUMBER	DESCRIPTION	QTY
	996-041906-001	Printed Circuit Board Assembly consisting of:	
C1,C2	945-040209-011	Capacitor, Electrolytic, 1000uf, +50/-10%, 35V	2
C3	946-040190-103	Capacitor, Polyester, 0.01uf, ±10%, 50V	1
C4	945-040209-010	Capacitor, Electrolytic, 470uf, +50/-10%, 50V	1
CR1 thru CR4	919-042019-001	Diode, 1N4004	4
	911-041866-001	Lug, Turret	11
	976-040791-001	Tie Wrap	1

TABLE 7-10
OCTAVE BUFFER PRINTED CIRCUIT BOARD ASSEMBLY BOARD 6
REPLACEMENT PARTS LIST

INDEX NO. OR REF DESIG	PART NUMBER	DESCRIPTION	QTY
	996-041895-001	Octave Buffer Printed Circuit Board Assembly consisting of:	
IC1,IC2,IC3	991-041101-001	Integrated Circuit, Operational Amplifier, IC741	3
	980-041184-001	Printed Circuit Board, Octave Buffer	1
	995-040982-003	Bracket, Angle	1
	904-040495-015	Washer, Lock No. 4	2
	806-023039-004	Screw, Phillips, 4-40 x 1/4 in.	2

TABLE 7-11
RIBBON CONTROLLER
REPLACEMENT PARTS LIST

INDEX NO. OR REF DESIG	PART NUMBER	DESCRIPTION	QTY
	980-042902-001	Printed Circuit Board Assembly consisting of:	
	980-042901-001	Printed Circuit Board	1
	997-040585-001	Ribbon Assembly	1
	997-041597-001	Wheel Assembly	1
CR1,CR2	919-041075-001	Diode, Signal	2
J1,J2	910-041632-001	Jack, Phone	2
PL2	910-042832-012	Connector, 12 Pin	1
R1,R3	853-424751-031	Resistor, 4.75K Ohm, ±1%, 1/4W, Metal Film, Fixed	2
R2	925-042389-001	Resistor, 5K Ohm, Trim Cermet	1
R4	925-040275-001	Resistor, 100K Ohm, Trim Carbon	1
R5	852-312222-001	Resistor, 2.2K Ohm, ±5%, 1/4W, Carbon Film, Fixed	1
R6	925-040294-001	Resistor, Potentiometer, Rotary, 50K Ohm	1
R7	852-312152-001	Resistor, 1.5K Ohm, ±5%, 1/4W, Carbon Film, Fixed	1
SW1,SW2	960-042638-002	Switch, Slide, SPDT	1

SECTION 8

MODIFICATIONS

8.1 SERVICE BULLETINS

Minimoog Service Bulletins are issued as necessary to increase product capability or to enhance performance. These are included in this manual assuming the information contained therein may be necessary for future maintenance. Each bulletin is identified by title.

8.2 OSCILLATOR BOARD ASSEMBLY (Board 1, Serial Numbers between 1300 and 10175)

Subject: To improve tracking and pitch stability.

Modifications:

1. Change R69, R105 and R141 from 6.8K ohms to 15K ohms, 1/2W, $\pm 5\%$ carbon.
2. Replace R78, R106 and R128 with RC Network, part number 949-041129-001.
3. Change R181 from 56K ohms to 51K ohms, 1/2W, $\pm 5\%$, carbon.
4. Change R170 from 15K ohms, $\pm 5\%$ to 15K ohms, $\pm 1\%$, metal film.
5. Change R162 from 3K ohms, $\pm 5\%$ to 3.01K ohms, $\pm 1\%$, metal film.
6. Change C3, C5 and C7 from 47pf to 100pf.

All parts listed are available in kit form, part number 997-043185-001.

8.3 CONTOUR GENERATOR ASSEMBLY (Board 2, Serial Numbers below 2000)

Subject: To reduce thumping which may occur when a key is depressed.

Modification:

Add a 10pf capacitor between pin 4B and pin 5B on the contour generator printed circuit board.

8.4 POWER SUPPLY ASSEMBLY (Board 3, Serial Numbers below 2000)

Subject: To reduce oscillator bleed-through and cross modulation.

Modification:

Replace 10 ohm resistor next to the +10V ADJ trim pot with a straight wire. Make sure wire does not touch the body of +10V ADJ trimpot.

8.5 FILTER ASSEMBLY (Board 4, Serial Numbers below 2000)

Subject: To reduce intermodulation distortion which occurs when mixing two or more signals.

Modifications:

1. Change R2 from 47K ohms to 160K ohms.
2. Change R8 and R28 from 27 ohms to 4.7 ohms.
3. Change R40 from 1K ohms to 10K ohms.

8.6 KEYBOARD CIRCUIT PRINTED CIRCUIT BOARD NO. 2

This modification is estimated to require 1 hour to perform. (Serial Numbers in the 7000's).

Pitch drift when key is released (DECAY switch on), keyboard circuit not sampling voltage consistently (correct pitch inconsistent) or keyboard circuit not functioning at all.

8.6.1 REASON

Excessive printed circuit board leakage caused by contaminants in board is usually only exhibited in humid conditions where moisture is apparently absorbed by the board. The keyboard sample and hold circuit is high impedance and is affected by this leakage.

8.6.2 MODIFICATION

Critical circuit components should be lifted off the board and soldered point-to-point on top of the board to eliminate any chance of voltage leakage from nearby traces to these critical areas. The accompanying schematic diagram shows the area affected by the leakage. The printed circuit board diagram shows leads lifted, jumper wires in place, and sections of traces to be cut. (Figure 8-1).

1. Lift the gate of Q10 and the drain of Q13. Bend the drain of Q13 under the transistor and bring it up between its source and gate.

2. Remove R21 (10K) from the board and solder it point-to-point (gate Q10 to drain Q13) on top of the board.

3. Solder a jumper wire from the drain of Q13 to the lead of C6. The lead of C6 must be either lifted from the board or the trace cut as shown.

Route a trace with a -10 volt potential away from the gate of Q13. This trace supplies R18 (3.9K), R34 (100K), R52 (43K) and R54 (1.5K) with -10 volts.

1. Cut this trace just above R52 and just below R18 as shown.

2. Lift the leads of R34 and C13.

3. Connect a jumper from R18 to R34 and C13 to R52.

8.7 MINIMOOG OSCILLATOR TUNING (Serial Numbers around 4185)

Subject: With filter contour ATTACK at some duration other than "0", oscillator number 2 appears

to have a slight amount of glide present. At the end of the selected duration, oscillator number 2 settles. This only occurs when a new trigger is generated, as by high stepping the keyboard.

Reason: Contour generator board 2 transistors Q1, Q4, Q6, Q7 and Q23 have been previously replaced with Motorola M62272A.

Modification:

Replace M62272A transistors with the normally used 2N3392.

8.8 OSCILLATOR BOARD 1, POWER SUPPLY CONNECTION AND OCTAVE BUFFER

Subject: Stabilized Oscillator Installation and Tuning (Serial Numbers below 10175).

Power Supply Connection Modification (All Serial Numbers).

Octave Buffer Kit Installation (Serial Numbers below 5000). Supersedes Bulletin M101 Octave Buffer Installation.

These out-of-warranty modifications are summarized below for labor estimation purposes by an authorized Moog Service Center:

Stabilized Oscillator Installation 1.0 hours
Octave Buffer Installation 1.5 hours

MODIFICATION PARTS LIST

PART NUMBER	DESCRIPTION	QTY.
997-043299-001	Stabilized Oscillator Kit consisting of:	1
996-041928-002	Stabilized Oscillator Board	1
913-043293-001	Template for rear panel	1
977-041638-003	Grommets	13
908-043294-001	Insulating "Fish" Paper for main frame	1

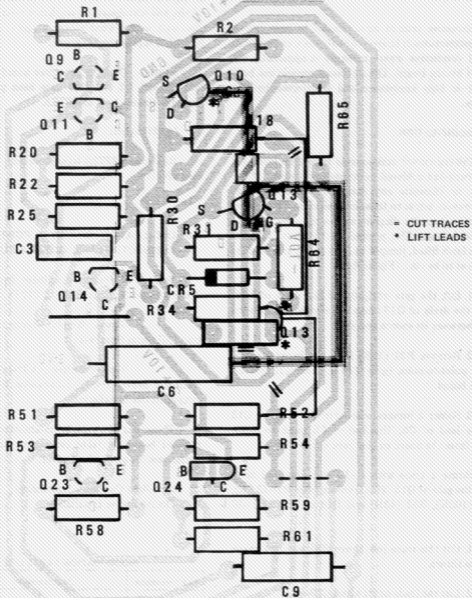

FIGURE 8-1 PRINTED CIRCUIT BOARD 2 MODIFICATIONS

8.8.3 SCALE TRIMPOT ADJUSTMENTS

- a. Set octave RANGE at 8'. Refer to Note 1.
- b. Press low A (55Hz) and zero beat with shift trimpot. Refer to Note. 2.
- c. Press high A (440Hz) and zero beat with scale trimpot.
- d. Repeat steps b and c until low A and high A zero beat.

8.8.4 HIGH END COMPENSATION

- a. Octave range is 2'. Refer to Note 1 and substitute 2' for 8'.
- b. Press low A (440Hz) and zero beat with shift trimpot. Refer to Note. 2.
- c. Press high A (3520Hz) and zero beat with high end trimpot.
- d. Repeat steps b and c until low A and high A zero beat.
- e. Recheck paragraph 8.8.3 and repeat paragraphs 8.8.3 and 8.8.4 if necessary.

8.8.5 OCTAVE ADJUSTMENT

- a. Octave RANGE is 32'. Refer to Note 1 and substitute 32' for 8'.
- b. Press high A (220Hz) and zero beat using shift trimpot. Refer to Note. 2.
- c. Octave RANGE is 2'. Refer to Note 1 and substitute 2' for 8'.
- d. Press high A (3520Hz) and zero beat using octave trimpot.
- e. Repeat steps a,b,c, and d until both 32' and 2' zero beat.

8.8.6 SHIFT TRIMPOT ADJUSTMENT

Press A³ (440Hz) and zero beat using shift trimpot. Refer to Note 1.

NOTE

The Minimoog is now in tune. Because of the very precise tracking of the three oscillators on the new board, it may seem at times that the instrument does not produce the "fat" rich, multiple oscillator sound. This is not the result of a change in the sound of the oscillator but can be the result of setting the oscillators too precisely at the same pitch. To achieve the rich sound, it will be necessary for the player to detune the front panel oscillator frequency control as desired for a rich, rolling sound.

8.8.7 POWER SUPPLY CONNECTION MODIFICATION

In the event that all oscillators appear to change scale or frequency, the power supply and/or power supply connectors are probably affecting the oscillator as well as the keyboard current drive circuitry.

To ensure that the power supply sense lines are terminated properly with the lowest possible resistance, solder the appropriate main harness wires to the "individual flag" lugs located in the printed circuit board connectors. (Figure 8-5).

The points are as follows:

Connector CO1A, Pins 17, 18, 19,
-5 volt supply, Board 1 Connector.

Connector CO1B, Pins 1, 2, 3, 4, 5, 6,
Main supply, Board 1 Connector.

Connector CO3, Pins 13, 14, 15, 16, 19, 20,
Main supply, Board 3 Connector.

Flag tools (Part Number 961-043266-001) are available from the factory to remove the "flag" lugs from the nylon AMP connectors. With care, a paper clip can be used in an emergency.

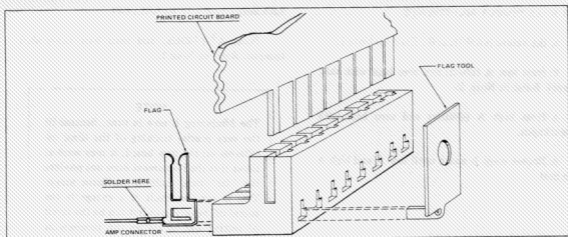

FIGURE 8-5 CONNECTOR MODIFICATION DIAGRAM

Each metal "flag" lug is constructed so that a one-way mechanical latch, consisting of a spring clip, locks the "flag" lug into the nylon connector housing. To remove the "flag", the tool is inserted into the connector as shown. This releases the spring clip. Using needlenose pliers, gently pull the associated wire straight out of the connector. The "flag" should freely slide out with the wire. Excessive force indicates that the spring clip is still engaged. When replacing, simply slide the "flag" back until it locks itself in place.

8.8.8 OCTAVE BUFFER KIT INSTALLATION

Buffer Kit, Part Number 997-043185-007, eliminates interaction between OSCILLATOR RANGE switches and improves overall tuning. Installation is as follows:

1. Remove the oscillator and contour boards from unit to expose the chassis wiring.
2. Replace the matched set of resistors mounted on the octave switch SW3 with the resistor values as indicated in the Parts List that follows.
3. Using the bracket provided in the kit as a guide, drill two holes for No. 4-40 screws in the chassis top and mount the octave buffer board between the RANGE switch and the WAVEFORM switches. Ensure the octave buffer board is mounted close enough to the front panel to prevent inter-

ference with the contour board. Refer to the furnished schematic, Figure 8-6 to connect the buffer board wiring.

BUFFER KIT PARTS LIST

PART NUMBER	DESCRIPTION	QTY.
997-043185-007	Buffer Kit consisting of:	1
949-041130-001	Resistors, R25 thru R28, Matched, Precision, 1K, $\pm 1\%$	4
853-424751-031	Resistor, R29, Precision, 4.75K, $\pm 1\%$	1
996-043249-001	Board, Octave Buffer	1
995-040982-003	Bracket, Angle	1
904-040495-015	Washer, Lock, No. 4	2
806-023039-004	Screw, Phillips, 4-40 x 1/4 inch	2

8.8.9 WIRE ROUTING

- Oscillator 1, SW3, white/green, to terminal 5.
- Oscillator 2, SW4, violet, to terminal 8.
- Oscillator 3, SW5, white/red, to terminal 2.
- Oscillator 1, Terminal 1, white/yellow, to CO1A-14.
- Oscillator 2, Terminal 4, orange, to CO1A-13.
- Oscillator 3, Terminal 6, white/brown, to CO1A-11.

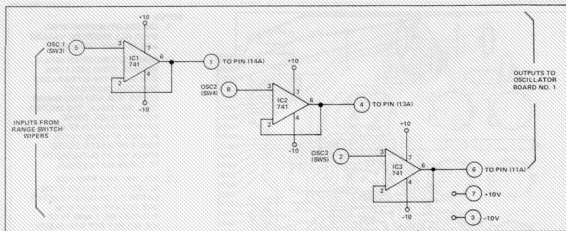
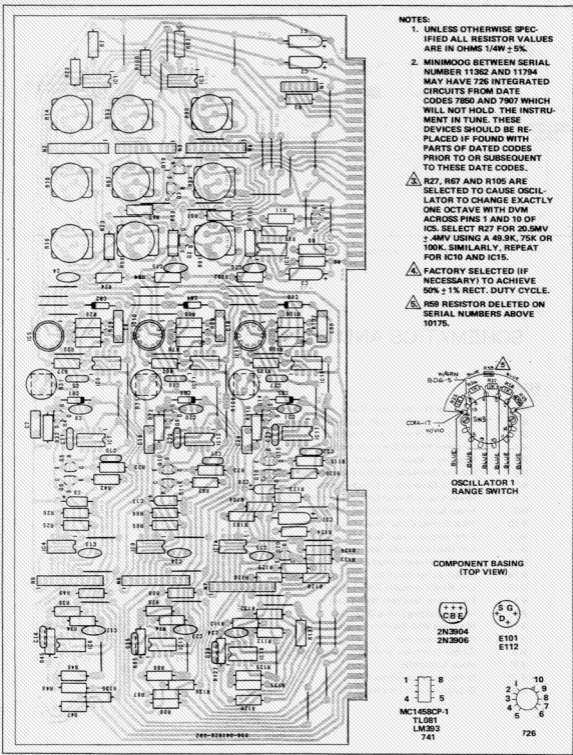

FIGURE 9-6 OCTAVE BUFFER SCHEMATIC

SECTION 9

SCHEMATICS AND PRINTED CIRCUIT BOARDS

FIGURE	TITLE	PAGE
9-1	Oscillator Printed Circuit Board No. 1 Assembly (Serial Number 10175 and Above)	9-1
9-2	Oscillator Printed Circuit Board No. 1 Schematic (Serial Number 10175 and Above)	9-1
9-3	Oscillator Printed Circuit Board No. 1 Schematic Diagram (Serial Numbers Below 10175)	9-2
9-4	Oscillator Printed Circuit Board No. 1 Assembly (Serial Numbers Below 10175)	9-2
9-5	Matching Transistor Circuits	9-3
9-6	Contour Generator and Keyboard Printed Circuit Board No. 2 Assembly	9-4
9-7	Contour Generator and Keyboard No. 2 Schematic Diagram	9-5
9-8	Power Supply Printed Circuit Board No. 3 Schematic Diagram	9-6
9-9	Power Supply Printed Circuit Board No. 3 Assembly	9-7
9-10	Filter Printed Circuit Board No. 4 Assembly	9-8
9-11	Filter Printed Circuit Board No. 4 Schematic Diagram	9-9
9-12	Left Hand Controller Schematic Diagram	9-10
9-13	Rectifier Printed Circuit Board No. 5 Schematic Diagram and Board Assembly	9-10
9-14	Octave Buffer Board No. 6 Schematic Diagram and Board Assembly	9-11
9-15	Left Hand Controller Assembly and Transformer Wiring	9-12
9-16	Front Panel Assembly Wiring Diagram	9-13
9-17	Interconnecting Wiring Diagram	9-14
9-18	Minimoog With Separate Keyboard	9-15
9-19	Ribbon Controller	9-16
9-20	Ribbon Controller Schematic Diagram and Board Assembly	9-17
9-21	Moog Accessories	9-18
9-22	Buffer Board Installation Kit	9-18
9-23	Oscillator Board Installation Kit	9-19



NOTES:

1. UNLESS OTHERWISE SPECIFIED ALL RESISTOR VALUES ARE IN OHMS $1/4W \pm 5\%$.
2. MINIMOOG BETWEEN SERIAL NUMBER 11362 AND 11794 MAY HAVE 726 INTEGRATED CIRCUITS FROM DATE CODES 7850 AND 7907 WHICH WILL NOT HOLD. THE INSTRUMENT IN TUNE. THESE DEVICES SHOULD BE REPLACED IF FOUND WITH PARTS OF DATED CODES PRIOR TO OR SUBSEQUENT TO THESE DATE CODES.

⚠ R27, R67 AND R105 ARE SELECTED TO CAUSE OSCILLATOR TO CHANGE EXACTLY ONE OCTAVE WITH DVM ACROSS PINS 1 AND 10 OF IC5. SELECT R27 FOR 20.5MV \pm 4MV USING A 49.9K, 75K OR 100K. SIMILARLY, REPEAT FOR IC10 AND IC15.

⚠ FACTORY SELECTED (IF NECESSARY) TO ACHIEVE $50\% \pm 1\%$ RECT. DUTY CYCLE.

⚠ R59 RESISTOR DELETED ON SERIAL NUMBERS ABOVE 10175.

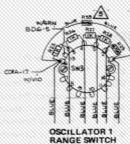

**COMPONENT BASING
(TOP VIEW)**



2N3904

2N3906



E101

E112



700-926190-906

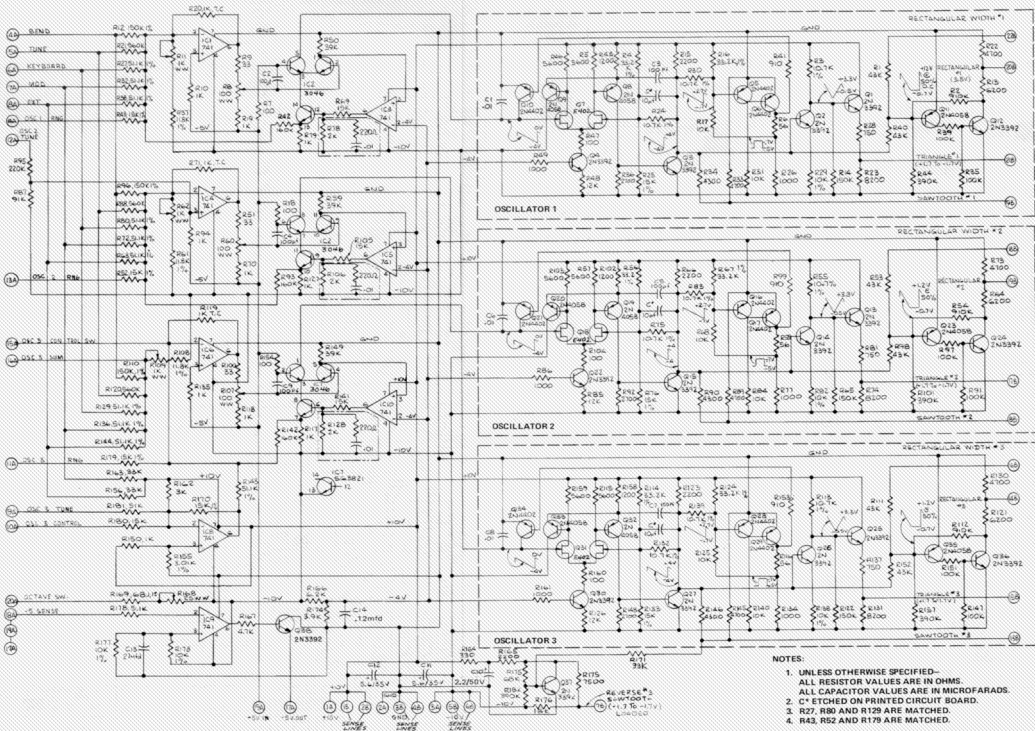
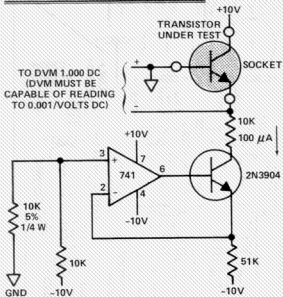
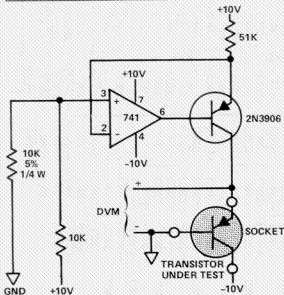

FIGURE 9-3 OSCILLATOR PRINTED CIRCUIT BOARD NO. 1 SCHEMATIC DIAGRAM (SERIAL NUMBERS BELOW 10175)

NPN TRANSISTORS 2N3904, 2N3392 (ETC.)



PNP TRANSISTORS 2N3906, (ETC.)



MATCHING PROCEDURE

1. SETUP $\pm 10V$ SUPPLIES TO $\pm 10.00 V$ OR $\pm 15.00 V$.
2. TAKE TRANSISTORS (APPROXIMATELY 20) AND PLACE THEM IN STYROFOAM TO STABILIZE AT ROOM TEMPERATURE.
3. PLACE TRANSISTORS INTO SOCKET, ONE AT A TIME, AND MEASURE BASE TO EMITTER VOLTAGE. DO NOT USE YOUR FINGERS. USE GLOVES OR PLIERS WITH INSULATING JAWS. YOUR FINGER HEAT WILL CAUSE THE READINGS TO VARY.
4. MARK DOWN THE V_{be} FROM THE DVM AND FIND TWO TRANSISTORS THAT THE V_{be} MATCHES TO $\pm 2 MV$.
5. EXAMPLE:

$$\begin{array}{r} \text{TRANSISTOR 1} = 0.600 \\ \text{TRANSISTOR 2} = 0.598 \\ \hline 0.002 \end{array}$$

FIGURE 9-5 MATCHING TRANSISTOR CIRCUITS

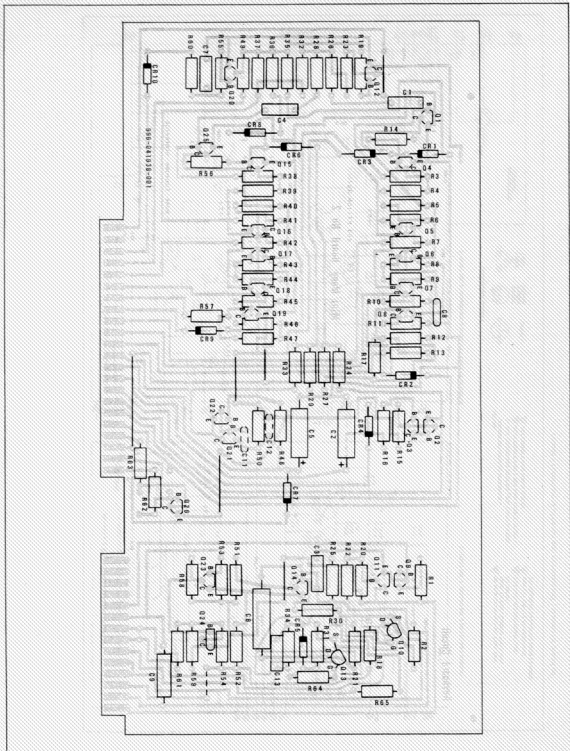
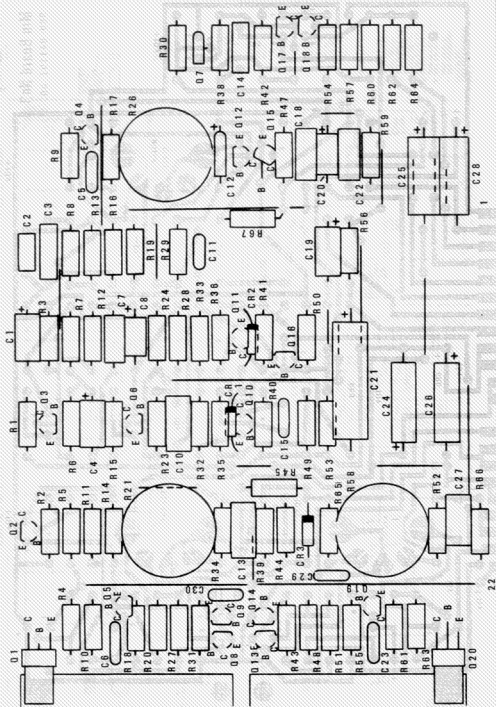

FIGURE 9-6 CONTOUR GENERATOR AND KEYBOARD PRINTED CIRCUIT BOARD NO. 2 ASSEA



386-011935-001

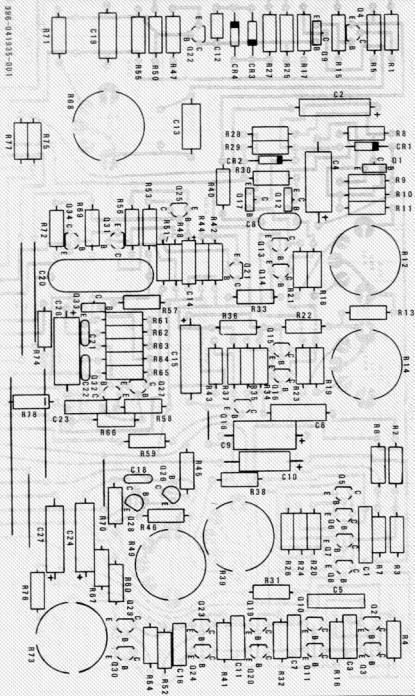

FIGURE 9-10 FILTER PRINTED CIRCUIT BOARD NO. 4 ASSEMBLY

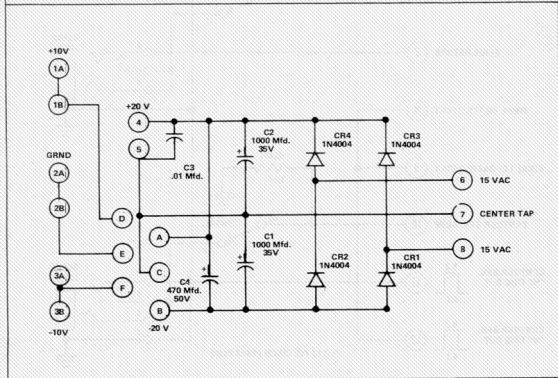
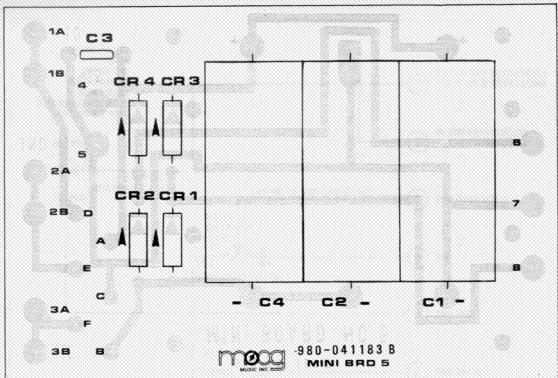

FIGURE 9-13 RECTIFIER PRINTED CIRCUIT BOARD NO. 5 SCHEMATIC DIAGRAM AND BOARD ASSEMBLY 9-10A

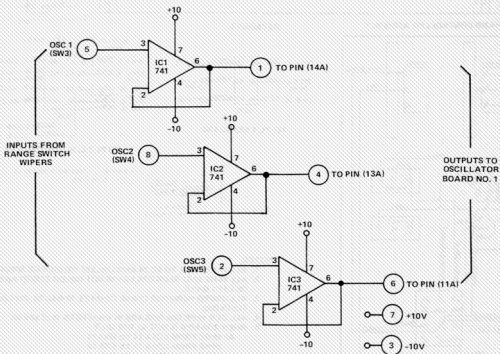
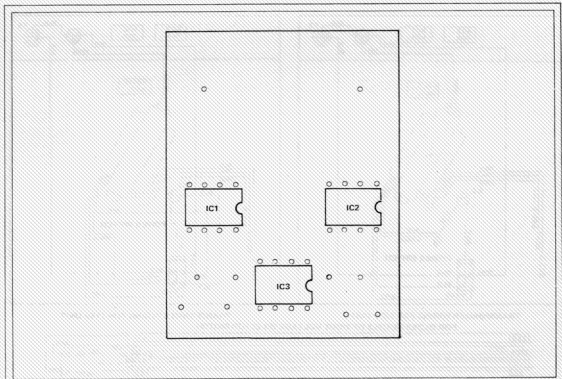

FIGURE 9-14 OCTAVE BUFFER BOARD NO. 6 SCHEMATIC DIAGRAM AND BOARD ASSEMBLY

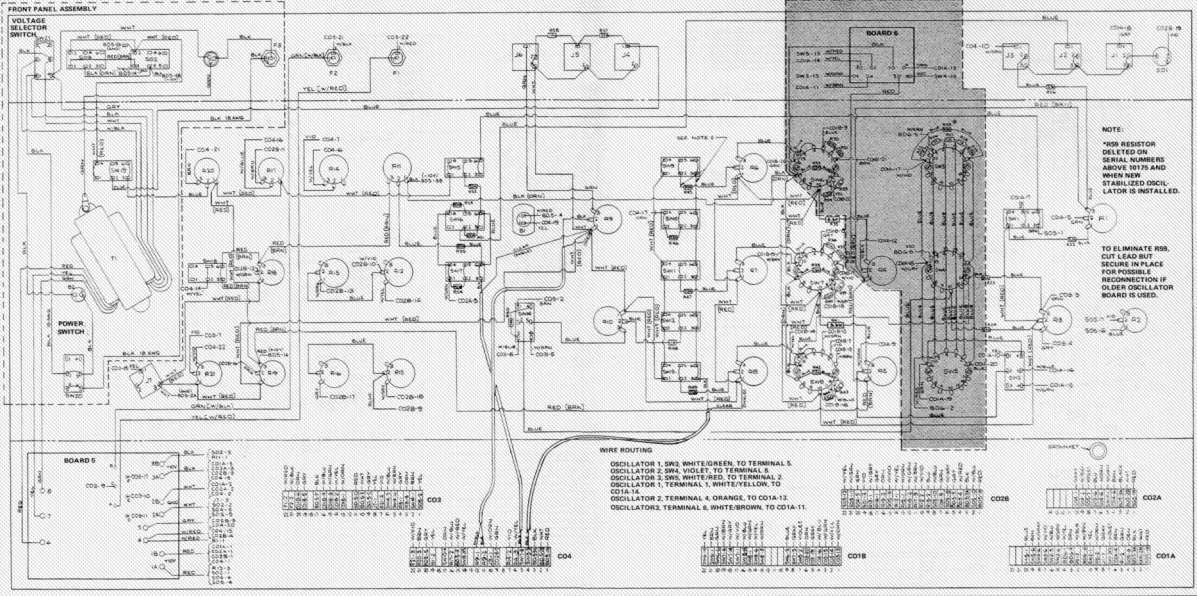
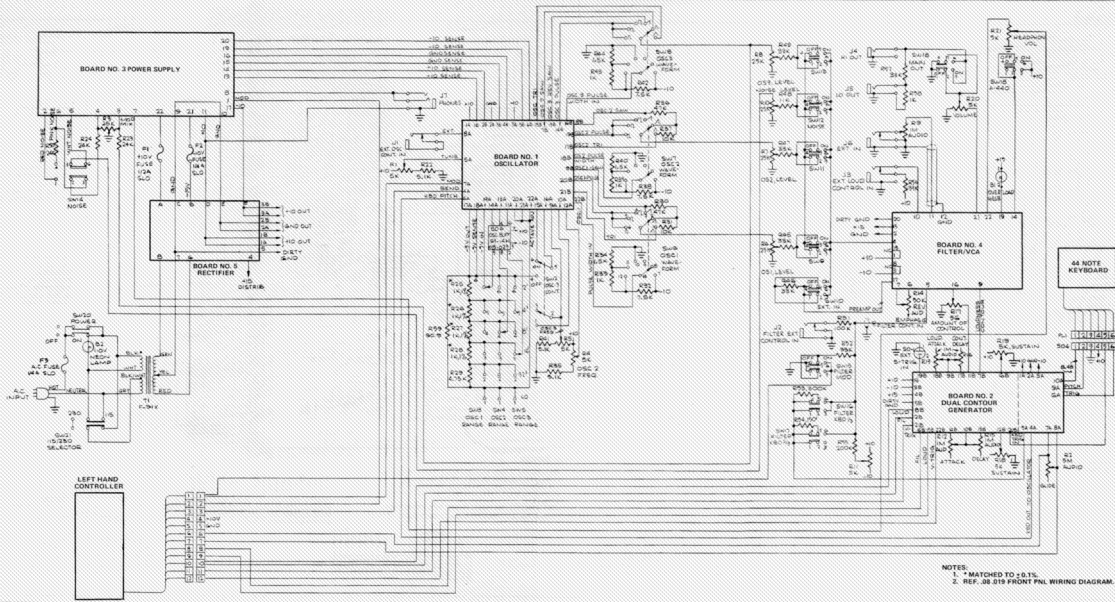

FIGURE 9-16 FRONT PANEL ASSEMBLY WIRING DIAGRAM



- NOTES
 1. * MATCHED TO ±0.1%
 2. REF. AS 219 FRONT PNL WIRING DIAGRAM.

FIGURE 9-17 INTERCONNECTING WIRING DIAGRAM

Use regular household 115V AC power. The 115V AC power is provided by the power supply. The power supply is located in the back of the power supply. The power supply is located in the back of the power supply.



AVAILABLE UPON SPECIAL REQUEST
FOR ADDITIONAL INFORMATION CONTACT YOUR LOCAL DEALER
SPECIFY CABLE LENGTH WHEN ORDERING

FIGURE 9-18 MINIMOOG WITH SEPARATE KEYBOARD

THE RIBBON CONTROLLER SHOWN HERE, ALONG WITH A SINGLE/MULTIPLE TRIGGER KEYBOARD AND TOUCH SENSITIVE KEYBOARD MAY BE SPECIAL ORDERED THROUGH MOOG CUSTOM ENGINEERING OR YOUR INTERNATIONAL DISTRIBUTOR



RIBBON CONTROLLER

FIGURE 9-19 RIBBON CONTROLLER

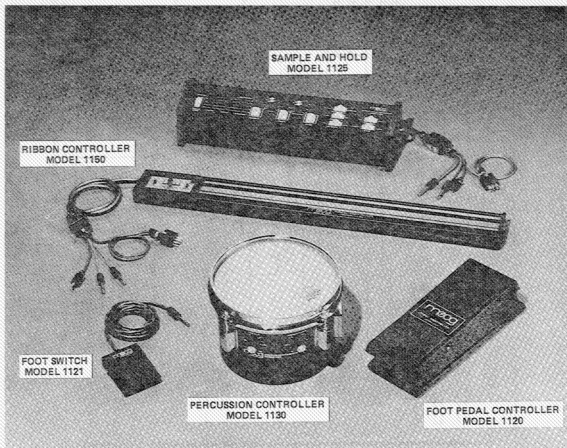

FIGURE 9-21 MOOG ACCESSORIES

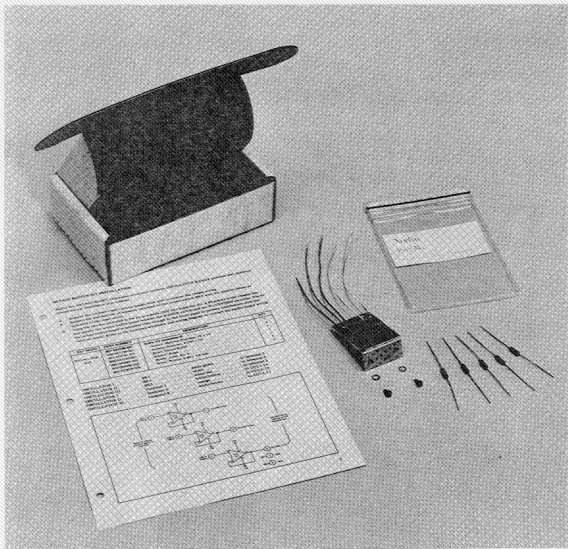

FIGURE 9-22 BUFFER BOARD INSTALLATION KIT

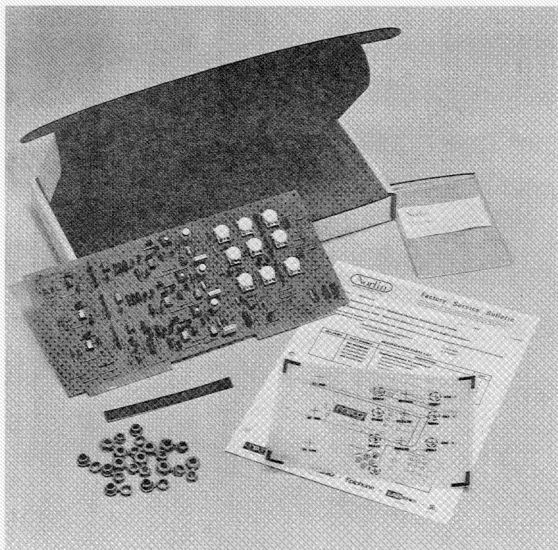

FIGURE 9-23 OSCILLATOR BOARD INSTALLATION KIT

MOOG Music Manufacturing

17 Blackstone Avenue
Jamestown, New York 14701