

 **Roland**

MICRO COMPUTER CONTROLLED RHYTHM MACHINE

CompuRhythm

CR-5000 OWNER'S MANUAL

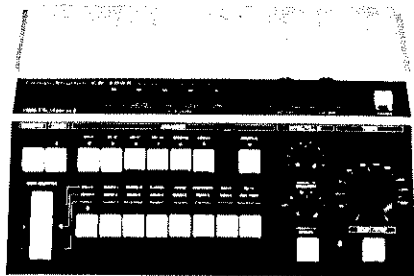

Features

Here's the most convenient rhythm machine, the new CR-5000 Compu Rhythm Unit from Roland, with new design and circuit.

This unit has 24 kinds of Basic rhythm patterns and 8 kinds of Intro/Fill-in rhythm patterns as preset rhythms. Moreover, this unit has attractive features as follows;

● Assorting Rhythm Pattern

This model CR-5000 has 24 kinds of Basic rhythm patterns and 6 preset rhythm patterns for Cymbal/Hi-Hat/Conga. So a wide range of rhythm variation can be produced by assorting these rhythm patterns.

● Available Crash and Shuffle functions

Equipped with Shuffle and Crash switch on the front panel. Shuffle function shuffles its rhythm entirely. Also, Crash function can insert the crash sound of Cymbal when the rhythm is changing from Intro/Fill-in to Basic rhythm.

● Level Control for each channel

Each sound source has Level Control which can control the balance of the rhythm sound to your preference.

Precautions

- Do not open this unit.
- Unplug this unit when it is not to be used for long periods of time. Unplug by grasping the plug rather than pulling the cord.
- Be careful not to place heavy objects on the power cord.
- Avoid using this unit in very high or low temperature locations. Also keep away from heaters and air-conditioners since this type of equipment will affect circuit and pitch stability.
- Avoid using this unit in very dusty or humid places.
- If it is necessary to use this unit in an area with neon or fluorescent lights, keep it as far away from these lights as possible since they will induce high levels of noise. Sometimes changing the angle of this unit in relation to the lights will help reduce noise.

Table of Contents

Features	1
Basic Connection	2
Front Panel	3
OPERATION	4
Intro/Fill-In Operation	5
■ To start from intro rhythm pattern	
■ To insert Fill-In rhythm pattern	
● Auto Fill-In	
● Manual Fill-In	
HOW TO USE THE CRASH SWITCH ..6	
HOW TO USE THE ARRANGER	
■ Cymbal and Hi-Hat arrangement	
■ Conga Arrangement	
■ Shuffle Arrangement	7
HOW TO USE THE REGISTER	
HOW TO PLAY	
PRESET RHYTHM	8
SPECIFICATIONS	11

Connection

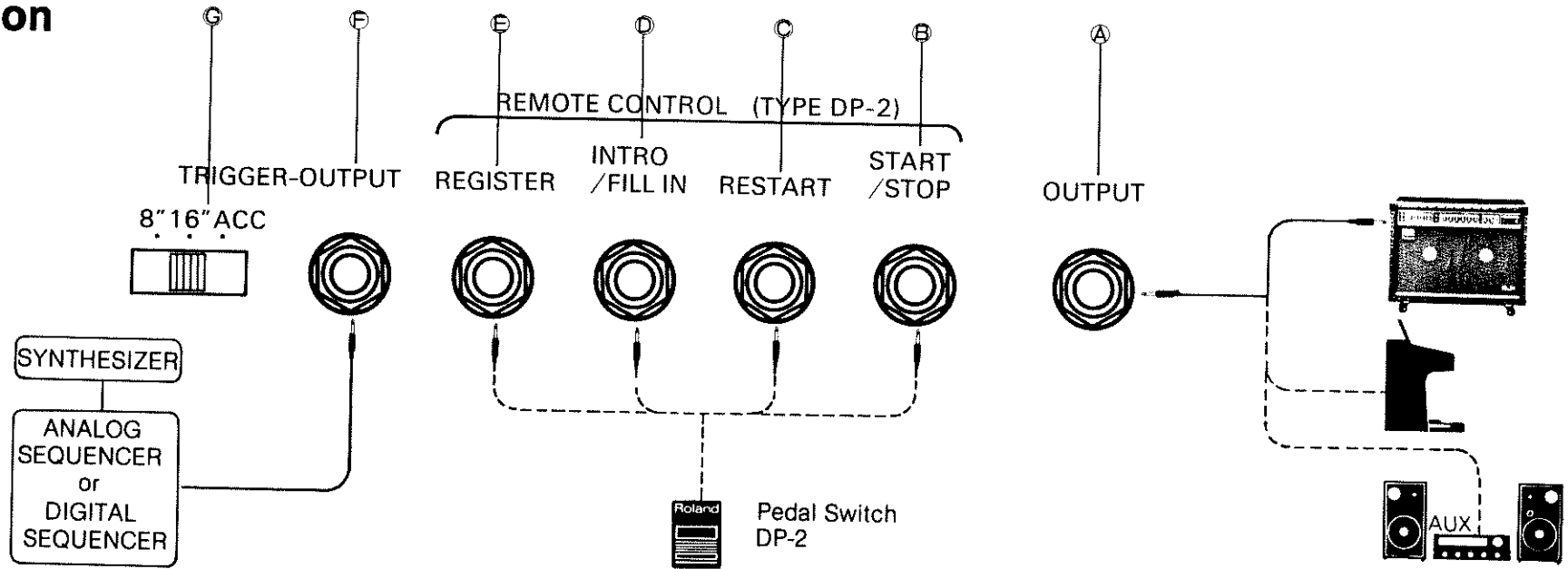

A OUTPUT

B START/STOP

C RE-START

Connect the Pedal Switch such as Roland's DP-2 to this jack. By depressing the pedal switch, the rhythm being played can be immediately returned to the beginning of the bar, which is available for adjustment of the beat that gets out of time during performance, or odd rhythm.

D INTRO/FILL-IN

This jack provides remote control options for the Intro or Fill-in function (without defeating those functions at the front panel Manual button).

E REGISTER

This jack provides remote control options for performing alternately two rhythm patterns without defeating this function at the front panel Register button.

F TRIGGER OUTPUT

CR-5000 has Trigger Out to control the Sequencer or Synthesizer.

G TRIGGER OUT 8"-16" SWITCHABLE

CR-5000 provides Trigger Output to allow interfacing with synthesizer or sequencer. This Trigger signal is a positive 5V, 10ms pulse suitable for activating either the Trigger or Gate input of most major brand of equipments.

Front Panel

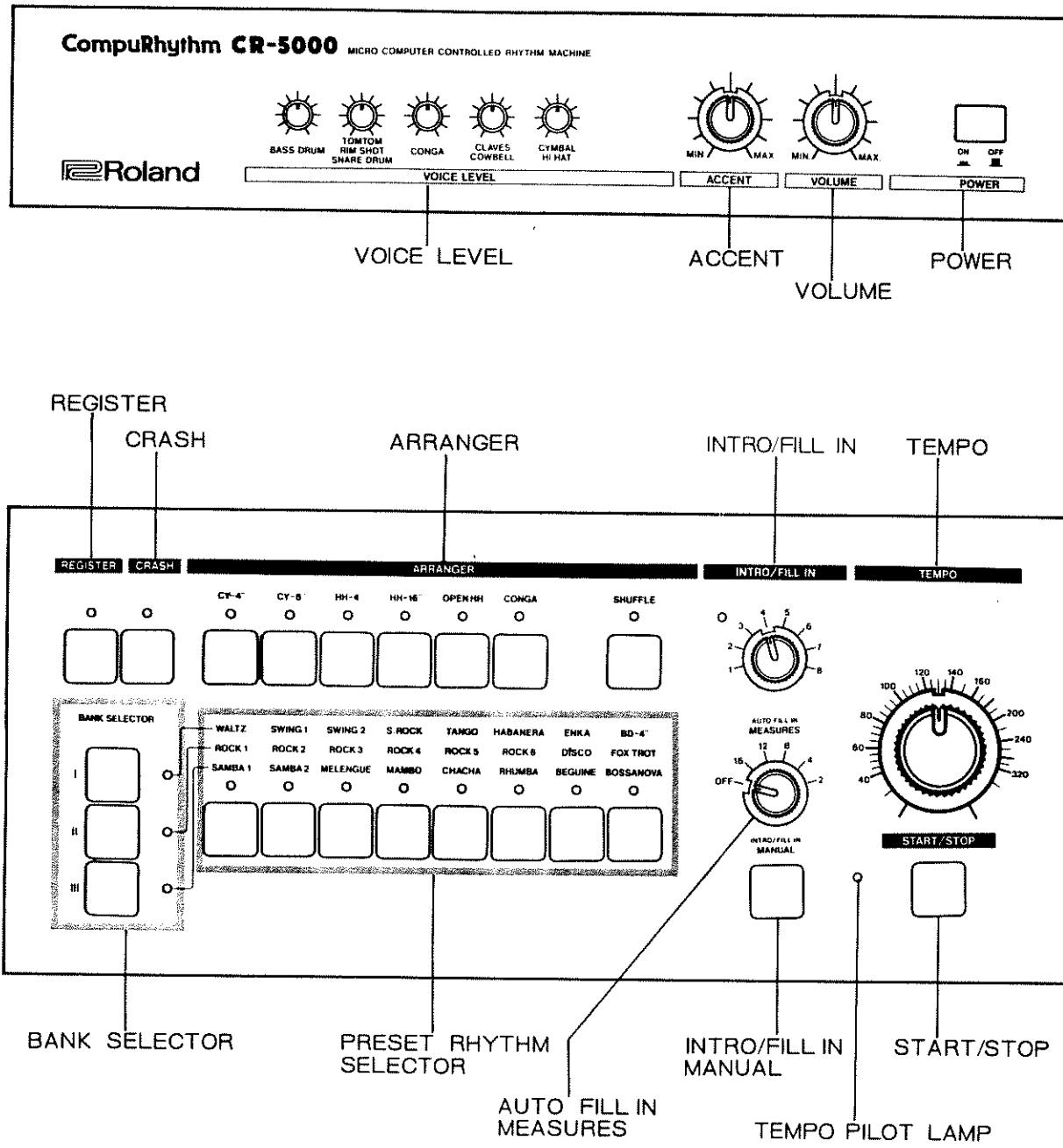

OPERATION

- 1 Check that power cord is correctly and firmly connected.
- 2 Push the Power switch to "ON" position.

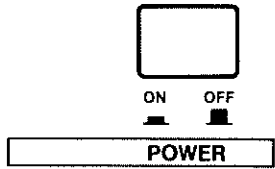

- 3 Select the desired rhythm pattern from 24 Basic Rhythm Patterns of preset by depressing the corresponding Bank Selector and Preset Rhythm Selector.

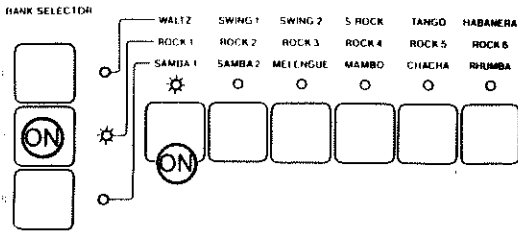

Note: When the desired rhythm is selected the LED illuminates. Also, you can combine two preset rhythm patterns by depressing two selectors simultaneously. However, if three or more selectors are pressed simultaneously, the two nearest to the left hand side will be selected. If WALTZ, SWING 1, SWING 2, SLOW ROCK and similar 3-beat rhythm or SHUFFLE TYPE rhythm are combined with a 4-beat type rhythm, the 4-beat type rhythm will be arranged to the particular 3-beat or shuffle-type rhythm.

- 4 Press the Start/Stop button to start the rhythm.

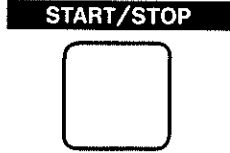

Note: When the rhythm starts, a Tempo LED will illuminate for each bar of the rhythm.

- 5 The Volume of each sound source can be adjusted by the Voice Level Control, and the overall volume by the Level Control.

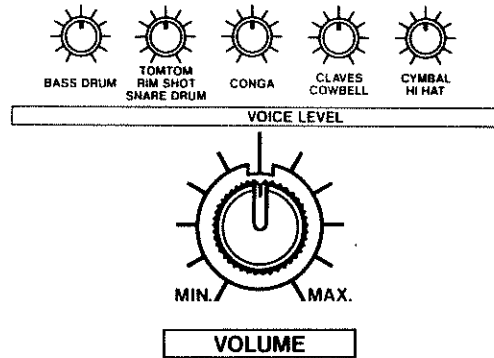

- 6 Determine the Tempo by turning the Tempo Control.

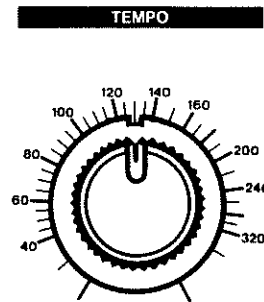

- 7 Accent Control is used to give dynamic emphasis to any other rhythm source on the same step. This level control adjusts the amount of emphasis.

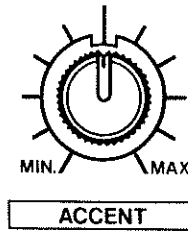

You can change the rhythm pattern without stopping playing. You can change the bank selector and the rhythm selector at will. The rhythm pattern will change the instant the button is pressed. For example, if the rhythm is changed exactly on the beat at the end of a bar, the new rhythm will begin from the beginning of the next bar. And if while using a 4/4 time you change rhythm at the 4th beat of the bar, the new rhythm will begin from that same 4th beat. (Even if the rhythm is changed, the overall beat will not be changed)

- 8 The running rhythm will be stopped by depressing the "Start/Stop" button again.

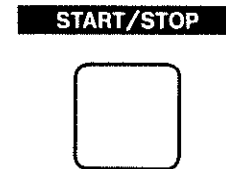

Intro/Fill-in Operation

To start from Intro rhythm pattern.

- 1 Select the desired rhythm pattern for Intro rhythm with Intro/Fill-In selector.

INTRO/FILL IN

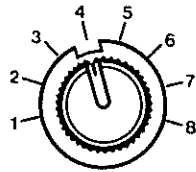

- 2 Select the desired Basic Rhythm pattern to be performed after Intro rhythm by depressing the Bank Selector and Preset Rhythm Selector.

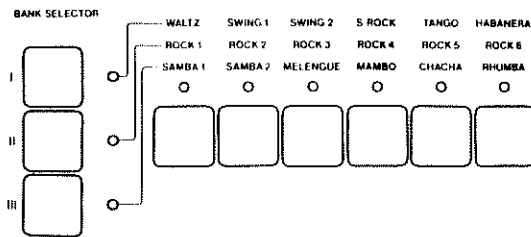

- 3 By pressing the Manual button, one bar of Intro Basic rhythm pattern will start performing.

**INTRO/FILL IN
MANUAL**

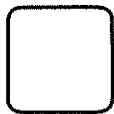

Note: Do not depress Start/Stop button to start the rhythm.

Auto Fill-In

To insert Fill-In rhythm pattern.

- 1 Select the Fill-In cycle with the Measure Selector. Automatic insertion of Fill-In rhythm is accomplished in any of the positions marked 16, 12, 8, 4 and 2. When set at these positions the Fill-In rhythm selected will play every 16th measure, every 12th measure, and so on.

**AUTO FILL IN
MEASURES**

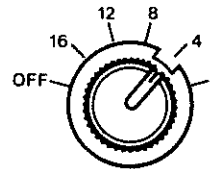

- 2 Select the desired rhythm with the Intro/Fill-In Selector.

INTRO/FILL IN

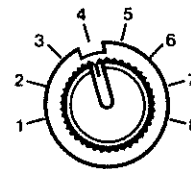

- 3 Select the Basic Rhythm Pattern with the Bank Selector and Preset Rhythm Selector.

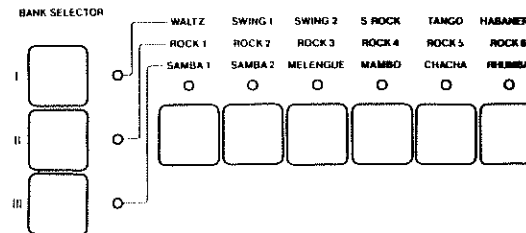

- 4 Push Start/Stop button to start the rhythm

START/STOP



Note: When the rhythm starts from Intro Rhythm Pattern, the Fill-In rhythm will be inserted in one bar early since the Intro rhythm is counted as the first bar. (From the second entry on, it will return to the selected cycle)

Manual Fill-In

When the Measure Selector is at the "OFF" position, Fill-In rhythm is inserted manually by depressing the Manual button. If you depress it exactly at the bar division, the Fill-In rhythm will be one bar that begins from the next bar. If you depress it at the 4th beat of 4/4 time, the Fill-In rhythm will be for one beat (the 4th beat of the Fill In rhythm). By holding down the Manual button the Fill-In rhythm can be inserted continuously for several bars.

**AUTO FILL IN
MEASURES**

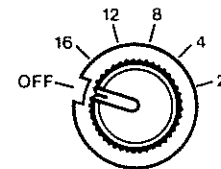

(HOW TO USE THE CRASH SWITCH)

By pushing this button, the crash sound of Cymbal can insert on the first beat when the rhythm is changed from Intro or Fill-In rhythm to Basic Rhythm Pattern. If you push again the button, the LED indicator goes out and it will be switched off.

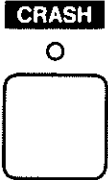

(HOW TO USE THE ARRANGER)

By depressing this Arranger button (LED indicator will illuminates), you can exchange preset Cymbal for Hi-Hat rhythm pattern, add a Cymbal, Hi-Hat or Conga rhythm as ADD VOICE, or change the whole rhythm over to a shuffle beat. If you push again this button, the LED indicator will go out and it will be switched off.

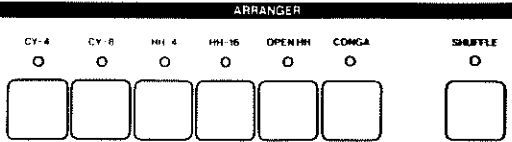

All of the buttons can be used in any combination with each other.

Cymbal and Hi-Hat arrangement

CY-4 A 4-beat Cymbal
 CY-8" An 8-beat Cymbal
 HH-4" A 4-beat Hi-Hat
 HH-16" A 16-beat Hi-Hat
 Open HH A 4-beat after-beat Open Hi-Hat
 If there is a Cymbal type sound source among the Preset Rhythm Patterns, the Cymbal type rhythm will change over to the selected rhythm when this button is depressed. Also, if there is no Cymbal type sound source among the preset rhythms, you can add the rhythm of the ADD VOICE you selected.

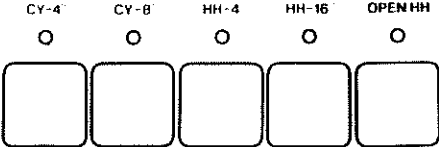

Conga Arrangement

Conga A combination of Hi-Conga and Lo-Conga.
 When you depress this button you can add a Conga rhythm as an ADD VOICE to any rhythm pattern.

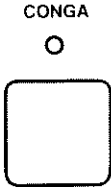

Shuffle Arrangement

When you depress this button you can change all rhythms to shuffle beats except for WALTZ, SWING-1, SWING-2 and SLOW ROCK.

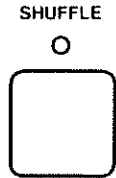

(HOW TO USE THE REGISTER)

By depressing the Register button, two kinds of Preset Rhythm Patterns can be played alternately.

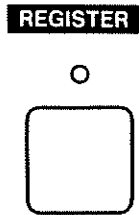

- 1 Set the first rhythm pattern on the Bank Selector, Preset Rhythm Selector or Arranger.

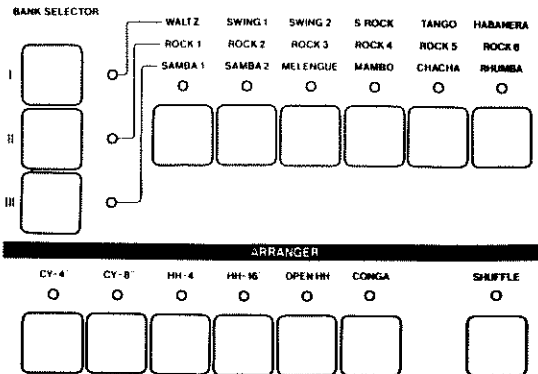

- 2 Push the Register Button. The LED indicator will flash indicating that the second rhythm pattern can now be set.

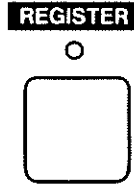

- 3 Set the second rhythm pattern.

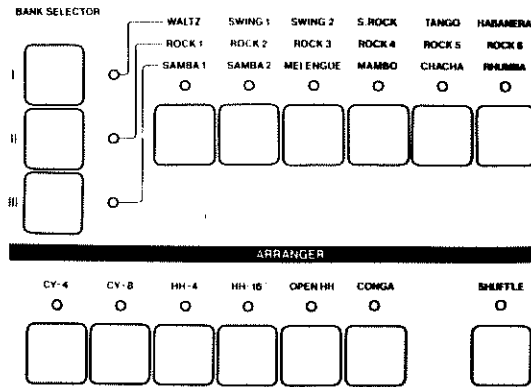





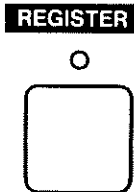





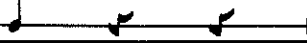

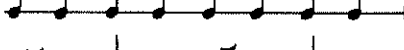

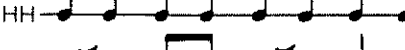



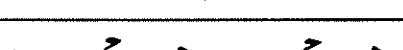





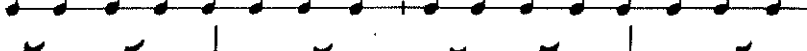





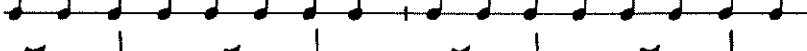





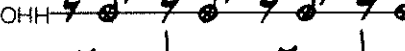
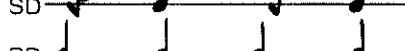

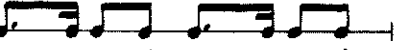





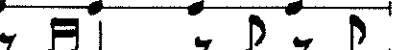





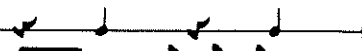
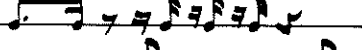

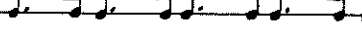

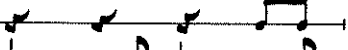
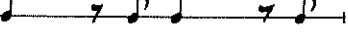



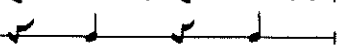
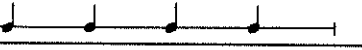

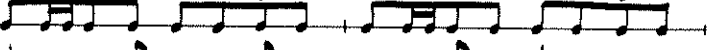
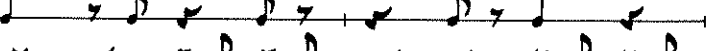
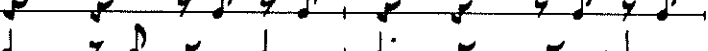

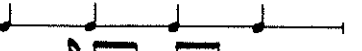
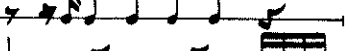

(HOW TO PLAY)

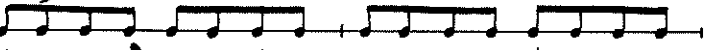
While a rhythm is being played, depress the Register button when you want to change the rhythm, and two set rhythm patterns will play alternately. Also you can change the set rhythm patterns as many times.

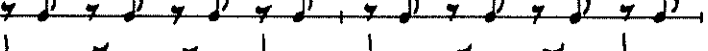
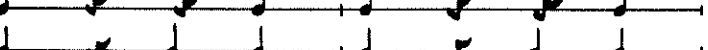
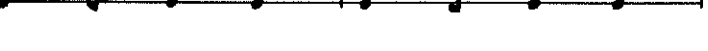
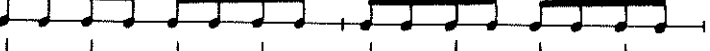

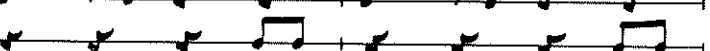
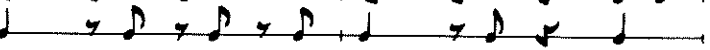
CR-5000 RHYTHM PATTERNS

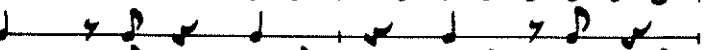
WALTZ	CY  SD  BD 	ROCK1	HH  SD  BD 	ROCK2	HH  SD  BD 
SWING1	OHH  HH  BD 	ROCK3	HH  SD  BD 		
SWING2	CY  BD 	ROCK4	HH  SD  BD 		
SLOW ROCK	HH  SD  BD 	ROCK5	HH  SD  BD 		
TANGO	OHH  SD  BD 	ROCK6	DISCO OHH  SD  BD 		
HABANERA	HH  SD  BD 	FOX TROT	OHH  HH  SD  BD 		
ENKA	HH  SD  BD 				
BD-4"	BD 				

<p>SAMBA 1</p>	<p>M </p> <p>HC </p> <p>CB </p> <p>MC </p> <p>LC </p> <p>BD </p>	<p>CHA CHA</p>	<p>M </p> <p>CB </p> <p>LC </p> <p>BD </p>
<p>SAMBA 2</p>	<p>M </p> <p>CB </p> <p>HC </p> <p>MC </p> <p>LC </p> <p>SD </p> <p>BD </p>	<p>RHUMBA</p>	<p>M </p> <p>C </p> <p>MC </p> <p>LC </p> <p>BD </p>
<p>MELE-NGUE</p>	<p>M </p> <p>CB </p> <p>MC </p> <p>LC </p> <p>BD </p>	<p>BEGUINE</p>	<p>M </p> <p>C </p> <p>MC </p> <p>LC </p> <p>BD </p>
<p>MANBO</p>	<p>M </p> <p>CB </p> <p>HC </p> <p>MC </p> <p>LC </p> <p>BD </p>	<p>BOSSA NOVA</p>	<p>OHH </p> <p>HH </p> <p>RS </p> <p>BD </p>

ARRANGER

INTRO/FILL IN

CY-4"		1		5	
CY-8"		2		6	
HH-4"		3		7	
HH-16"		4		8 (BREAK)	
OHH					
CONGA					

SPECIFICATIONS

- PRESET RHYTHM : 24
- PRESET RHYTHM Selector : 8
- BANK Selectors : 3
 - BANK I . . . WALTZ, SWING 1, SWING 2, S.ROCK, TANGO, HABANERA, ENKA, BD-4"
 - BANK II . . . ROCK 1 ~ 6, DISCO, FOX TROT
 - BANK III . . . SAMBA 1, SAMBA 2, MELENJE, MAMBO, CHACHA, RHUMBA, BE-GUINE, BOSSANOVA
- SOUND SOURCE
 - BASS DRUM, SNARE DRUM, LOW TOM, HI TOM, HI HAT, CYMBAL, RIM SHOT, LOW CONGA, MIDDLE CONGA, HI CONGA, COWBELL, CLAVES
- INTRO/FILL IN
 - INTRO/FILL IN Selector : 1 (1 ~ 8)
- INTRO/FILL IN MEASURES Selector : 1 (OFF, 16, 12, 8, 4, 2)
- ARRANGERS : 7
 - CY-4", CY-8", HH-4", HH-16", OPEN HH, CONGA, SHUFFLE
- CONTROL Buttons : 4
 - INTRO/FILL IN MANUAL
 - START/STOP, REGISTER, CRASH
- VOICE LEVELS
 - BASS DRUM
 - SNARE DRUM/RIM SHOT/TOM TOM (HI TOM, LOW TOM)
 - CONGA (LOW CONGA, MIDDLE CONGA, HI CONGA)
 - COWBELL/CLAVES
 - CYMBAL/HI HAT/OPEN HI HAT

- ACCENT VOLUME : 1
- LEVEL Control : 1
- TEMPO Control : 1
- POWER Switch : 1
- REMOTE COTROLS (DP-2) : 4
 - START/STOP
 - RESTART
 - INTRO/FILL IN
 - REGISTER
- OUTPUT : 1
- TRIGGER OUTPUT : 1
 - (f + 5V, 10ms Pulse)
 - TRIGGER PULSE Select Switch : 1 (8", 16", ACC)
- TEMPO PILOT LAMP : 1
- Power Consumption : 10W
- Dimensions : 331(W) × 278(D) × 108(H)mm
- Weight : 3.7kg
- Accessories : 2.5m connection cord × 1

*Specifications are subject to change without notice.

OPTION

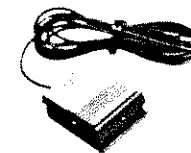

PEDAL SWITCH DP-2

Roland®

RUS10074

UPC

RUS10074



18981

Roland®