

ANALOG ECHO DC-10

C O N T E N T S

SPECIFICATIONS	1
DISASSEMBLY	1
CIRCUIT DESCRIPTION	2-3
BLOCK DIAGRAM	4
CIRCUIT DIAGRAM (SERIAL NO. UP TO 651699)	5
PCB ET-20A (SERIAL NO. UP TO 651699)	6
CIRCUIT DIAGRAM (SERIAL NO. 651700 AND HIGHER)	7
PCB ET-20B (SERIAL NO. 692450 AND HIGHER)	8-9
PCB ET-20B' (SERIAL NO. 651700 - 682499)	10
ADJUSTMENT	11-13
PARTS ILLUSTRATED	14-15
PARTS LIST	16

SPECIFICATIONS

INPUT	Input Jack	1
	Volume Control	1
	Input Level / Impedance...	-50dB(3.16mV)/4.7Kohm -35dB(17.8mV)/470Kohm -20dB(100mV) /470Kohm
OUTPUT	Output Jack D+E (Direct)	1
	Echo	1
	Output Level / Impedance	H: -20dB(100mV)/below 1Kohm L: -35dB(17.8mV)/below 1Kohm
ECHO	Echo Volume Control	1
	Repeat Rate Control	1
	Intensity Control	1
	Delay Time Control	(20 - 400mS)
	Frequency Response	(10 - 1.5KHz)
OTHERS	Echo ON/OFF Footswitch Jack	1
	Peak Level Lamp	1
	Power Pilot Lamp	1
	Power Switch	1
DIMENSIONS	340(W) x 95(H) x 160(D)mm 13.5(W) x 3.8(H) x 6.3(D)in	
WEIGHT	2.8kg, 6.2 lbs.	
POWER CONSUMPTION	5W(100/117V) 4W(220/240V)	
ACCESSORY	Connection Cord (2.5m)	

DISASSEMBLY

To disassemble COVER NO.154, remove FOUR SCREWS (binding head screw, 4 x 8, Br) at the bottom. Four screws at the sides (binding head screw, 4 x 8, Br) need not be removed for disassembling the cover.

CIRCUIT DESCRIPTION

1. LIMITER CIRCUIT

This circuit is constructed with differential amplifier with Dual FET E-412 (Q22). When input signal voltage rises over 2Vp-p, the signal is soft-distorted in order to prevent uncomfortable distortion at BBD.

2. FCF

This is a combination of C MOS IC, TC4016P (IC10-12) (analog switch), with 3-stage active low pass filter which is constructed of transistors (Q2-4, Q8-10), resistors and capacitors.

FCF stands for Frequency Controlled Filter whose cutoff frequency changes in synchronization with Clock Generator frequency.

By applying one-shot pulses of a certain frequency, which is generated by Clock Generator, to the gate of

switching device in TC4016P, this device has a certain resistance which varies in accordance with one-shot pulse frequency variation. By incorporating the switching device in low pass filter, the cutoff frequency can be controlled by the one-shot pulse frequency.

One-shot pulse frequency is varied from 40 to 800KHz by Repeat Rate control on DC-10 panel, making FCF cutoff frequency vary from 2 to over 10KHz. (See Diagram - 1.)

3. FIXED FILTER

After passing through FCF, input signal enters Fixed Filter which is two stage active low pass filter constructed of transistors, resistors and capacitors.

This fixed filter removes the one-shot pulse which is applied to TC4016P gate of FCF and superimposed on FCF output sound signal.

Two fixed filters, whose cutoff frequency is 12KHz, are provided before and after BBD. The filter before BBD slightly boosts high frequency while that after slightly cuts it. (See Diagram - 2.)

DIAGRAM - 1.

FCF RESPONSE (INPUT:-10dBm sine wave, 1KHz)

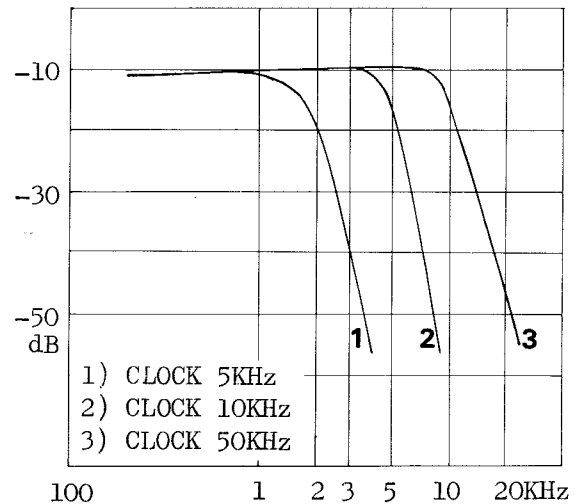

- 1) CLOCK 5KHz
- 2) CLOCK 10KHz
- 3) CLOCK 50KHz

100 1 2 3 5 10 20KHz

DIAGRAM - 2. FIXED FILTER RESPONSE

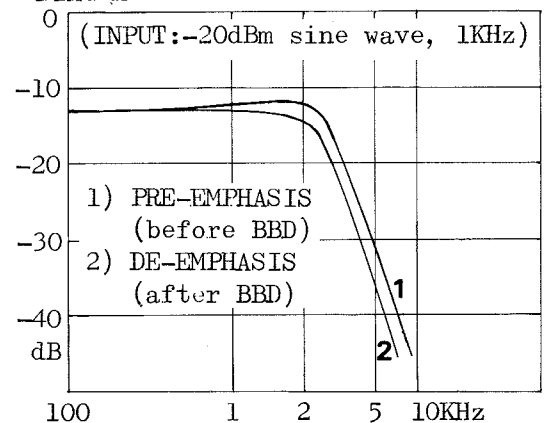

- 1) PRE-EMPHASIS
(before BBD)
- 2) DE-EMPHASIS
(after BBD)

100 1 2 5 10KHz

DIAGRAM - 3.

EMPHASIS RESPONSE

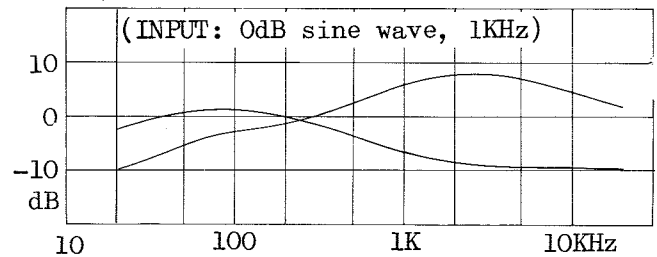

4. EMPHASIS

In order to better S/N ratio, pre-emphasis and de-emphasis circuits, constructed of Dual Operational Amplifier NJM4558D, are provided before and after BBD respectively.

Flat frequency response can be obtained by pre-emphasis of signal at around 4KHz and by de-emphasis at the same frequency range to restore to its original response. (See Diagram - 3.)

5. BBD

The 4096-stage BBD MN3005 is employed to attain a maximum delay time of 400ms at 5KHz clock frequency.

6. MUTING CIRCUIT

Muting circuit suppresses transient noise that is caused immediately after the power switch is turned on. When the power switch is turned on, a negative voltage is applied to FET Q20 gate to turn off the FET to cut off the ECHO output. Then the applied voltage decreases gradually at the rate of R84 and C54 time constant to turn on the FET. Thus the ECHO output is delivered.

7. NOISE KILLER

This circuit, constructed of Operational Amplifier TA7136P (IC5) and FET Q21, lowers noise level, when no signal is inputted, by lowering the high range response of Echo circuit.

8. CLOCK GENERATOR

This circuit generates clock pulses for BBD and one-shot pulses for TC4016P.

Clock pulses are prepared as follows:

C MOS IC TC4069P (IC6) containing 6 inverters is used. Three out of the six inverters are used to generate an alternating signal of 40K - 800KHz. The signal is passes through three stages of flip flop circuit of DN819 (IC7), and C MOS IC TC4013 (IC8) to undergo dividing and shaping. Thus square waves of 5K - 100KHz, with a duty factor of 50% are produced. The signal is then passed through complementary circuits of Q14/18. and Q15/19 to withstand the capacitive load of BBD.

On the other hand, one-shot pulses of 1us are produced by the remaining three inverters of TC4069P (IC6) and are applied to TC4016P.

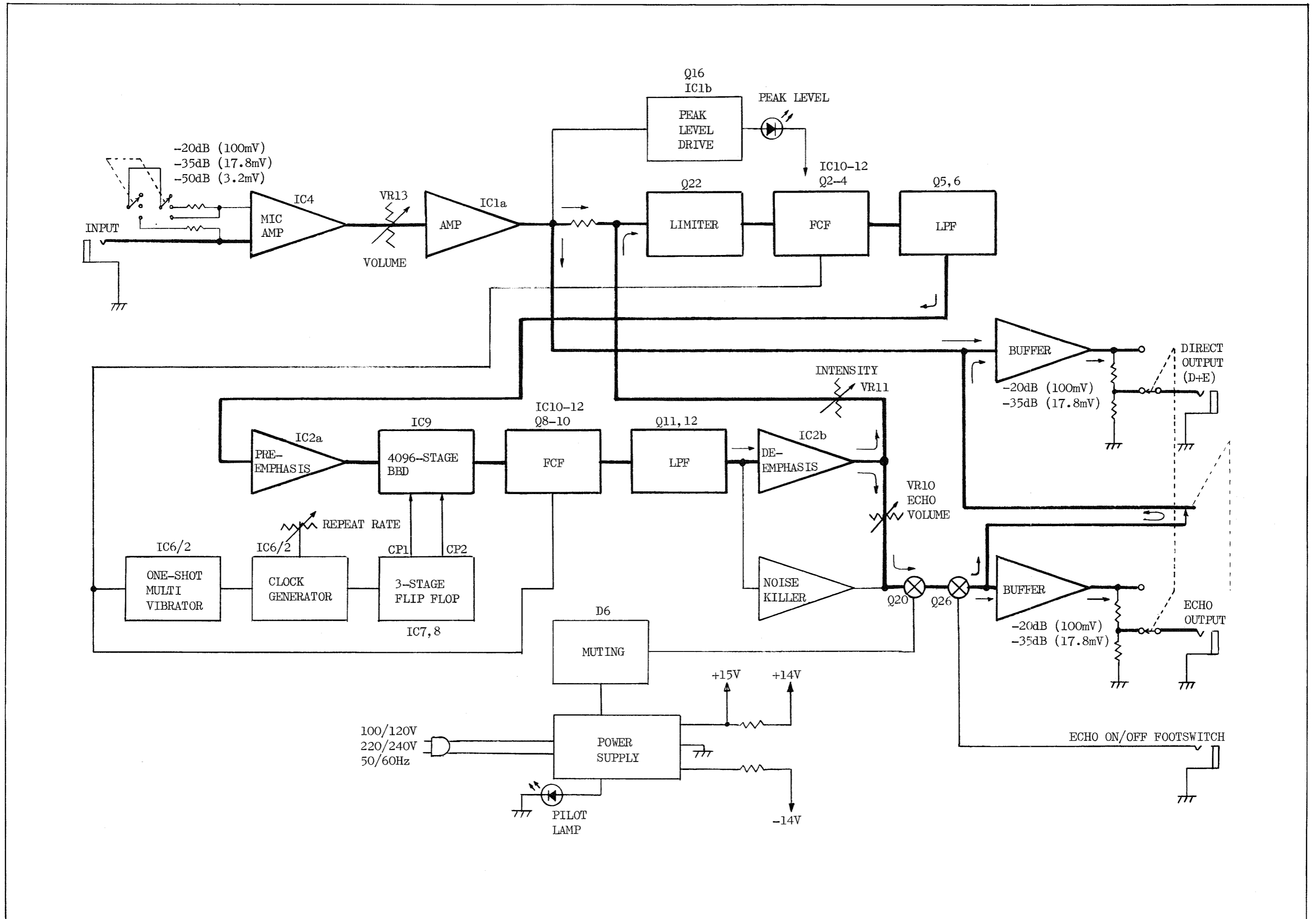

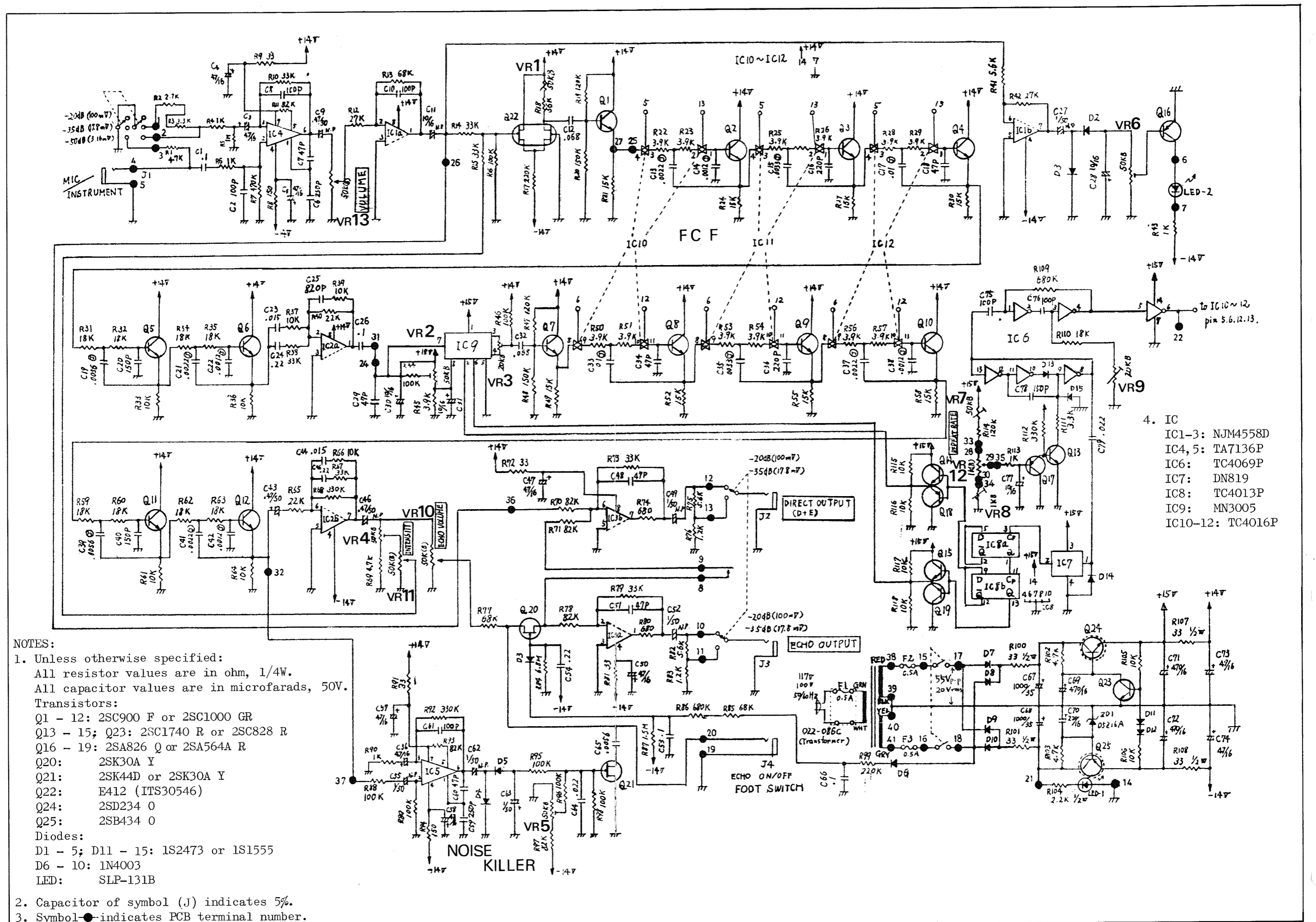

4. IC
 IC1-3: NJM4558D
 IC4, 5: TA7136P
 IC6: TC4069P
 IC7: DN819
 IC8: TC4013P
 IC9: MN3005
 IC10-12: TC4016P

- NOTES:
 1. Unless otherwise specified:
 All resistor values are in ohm, 1/4W.
 All capacitor values are in microfarads, 50V.
 Transistors:
 Q1 - 12: 2SC900 F or 2SC1000 GR
 Q13 - 15; Q23: 2SC1740 R or 2SC828 R
 Q16 - 19: 2SA826 Q or 2SA564A R
 Q20: 2SK30A Y
 Q21: 2SK44D or 2SK30A Y
 Q22: E412 (ITS30546)
 Q24: 2SD234 O
 Q25: 2SB434 O
 Diodes:
 D1 - 5; D11 - 15: 1S2473 or 1S1555
 D6 - 10: 1N4003
 LED: SLP-131B

2. Capacitor of symbol (J) indicates 5%.
 3. Symbol ● indicates PCB terminal number.

ET-20A (151-020A)
 PCB less parts (052-301A) 3P TYPE
 (Others, jumped)

For replacement, use ET-20B (151-020B).
 Note that ET-20 does not contain VR10-13.

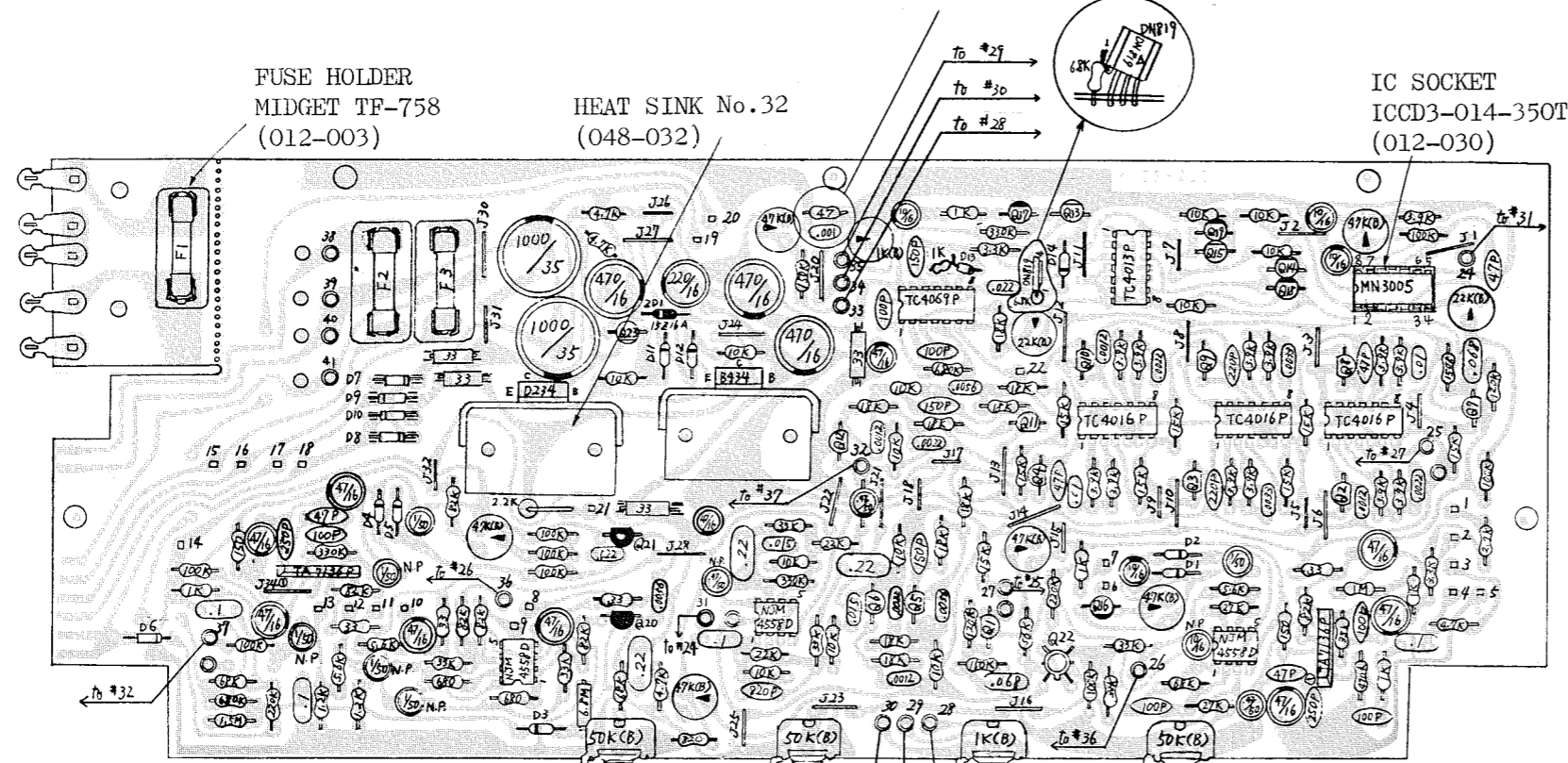

TOP VIEW

- Q1-12: 2SC900 F or 2SC1000 GR
- Q13-15; 23: 2SC1740 R or 2SC828 R
- Q16-19: 2SA826 Q or 2SA564 R
- Q21: 2SK44D or 2SK30A Y
- Q20: 2SK30A Y
- D1-5, 11-15: 1S2473 or 1S1555
- D6-10: 1N4003
- ZD1: 05Z16A
- Q22: E412 (ITS30546)

- VR10 ECHO
- VR11 INTENSITY
- VR12 REPEAT RATE
- VR13 VOLUME
- EVH-CCAK20B54 (028-483) or VM10R50K B20K (028-576)
- EVH-CCAK20B54 (028-483) or VM10R50K B20K (028-576)
- EVH-CCAK20B54 (028-483) or VM10R1K B20K (028-572)
- EVH-CCAK20B54 (028-483) or VM10R50K B20K (028-576)

FUSE	F1	F2, 3
100/117/117-3P	SGA0.5A (008-024)	SGA0.5A (008-024)
220-J/240-J/240	CEE100mAT (008-056)	CEE250mAT (008-060)

VIEW OF THE FOIL SIDE

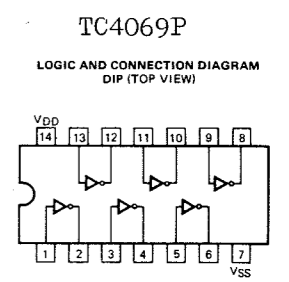
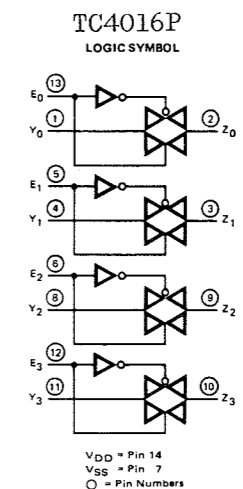
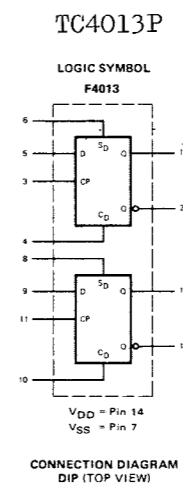
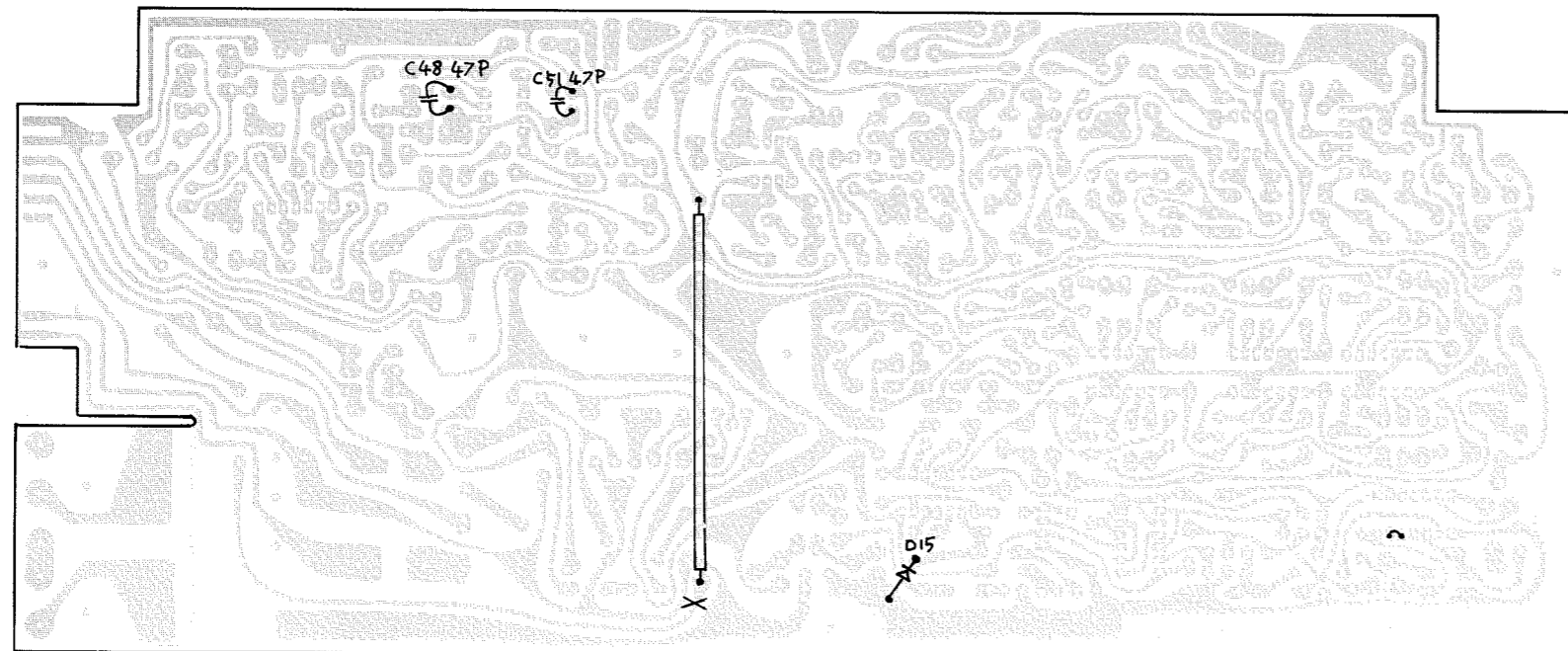

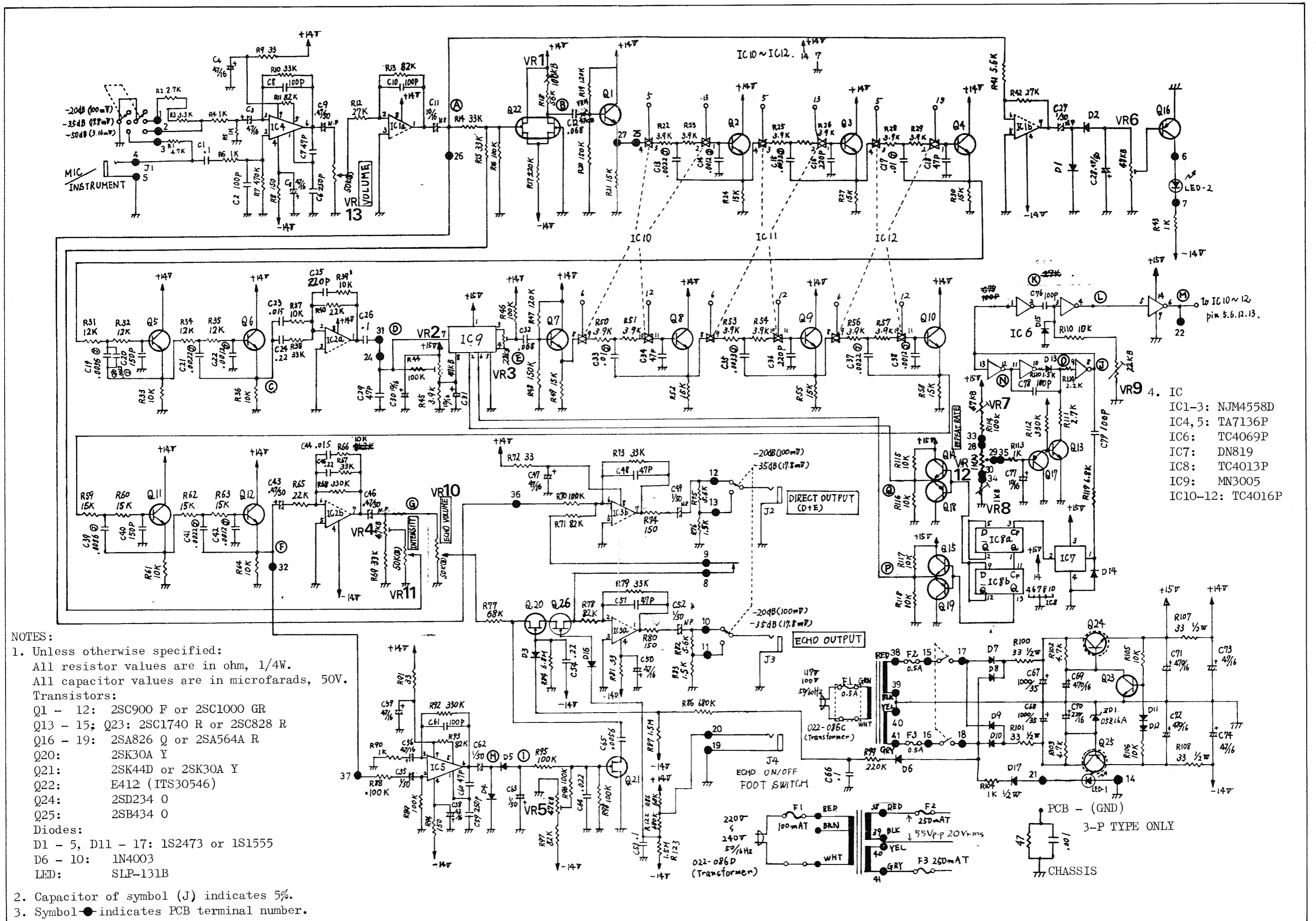

4. IC
 IC1-3: NJM4558D
 IC4, 5: TA7136P
 IC6: TC4069P
 IC7: DN819
 IC8: TC4013P
 IC9: MN3005
 IC10-12: TC4016P

- NOTES:
 1. Unless otherwise specified:
 All resistor values are in ohm, 1/4W.
 All capacitor values are in microfarads, 50V.
 Transistors:
 Q1 - 12: 2SC900 F or 2SC1000 GR
 Q13 - 15; Q23: 2SC1740 R or 2SC828 R
 Q16 - 19: 2SA826 Q or 2SA564A R
 Q20: 2SK30A Y
 Q21: 2SK44D or 2SK30A Y
 Q22: E412 (ITS30546)
 Q24: 2SD234 O
 Q25: 2SB434 O
 Diodes:
 D1 - 5, D11 - 17: 1S2473 or 1S1555
 D6 - 10: 1N4003
 LED: SLP-131B

2. Capacitor of symbol (J) indicates 5%.
 3. Symbol ● indicates PCB terminal number.

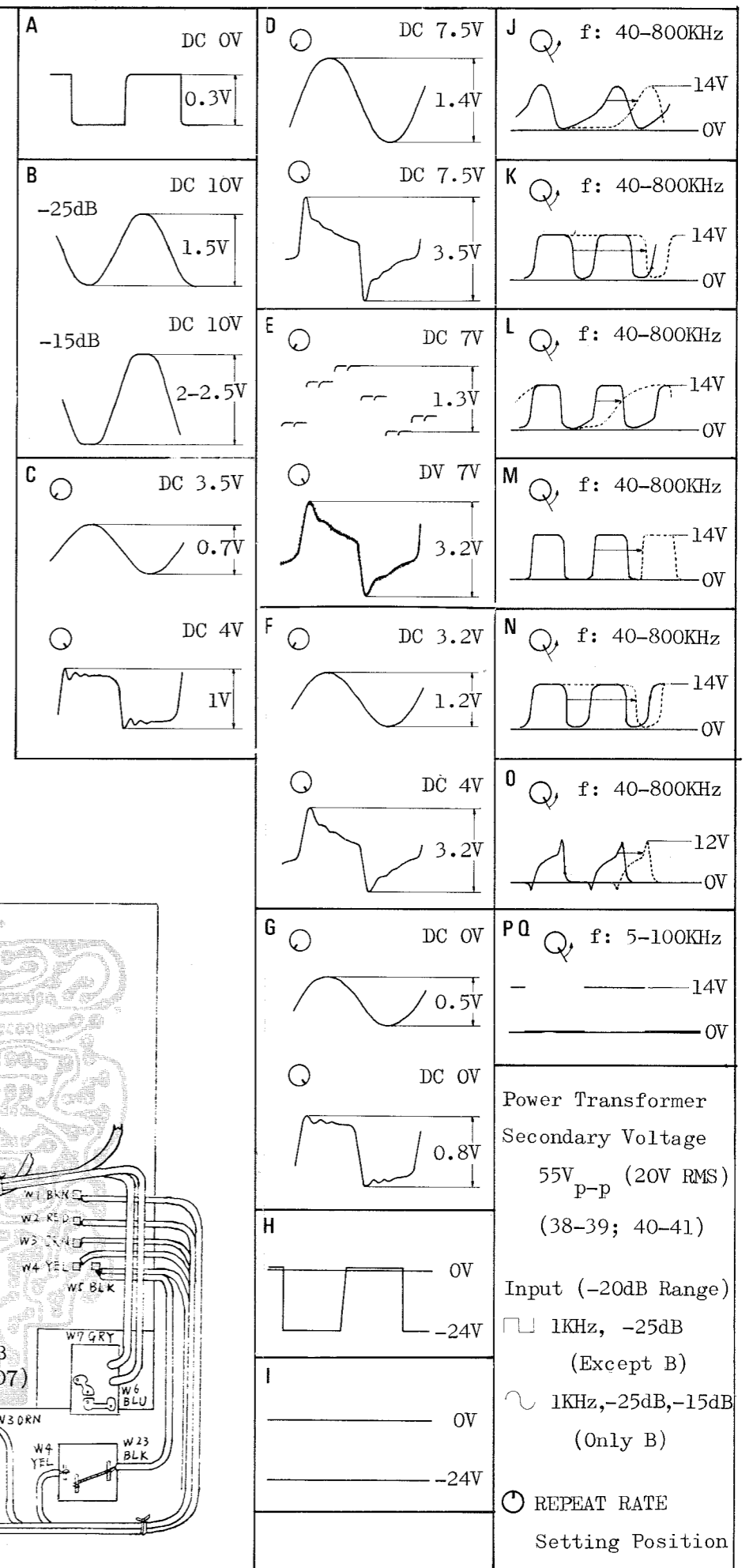
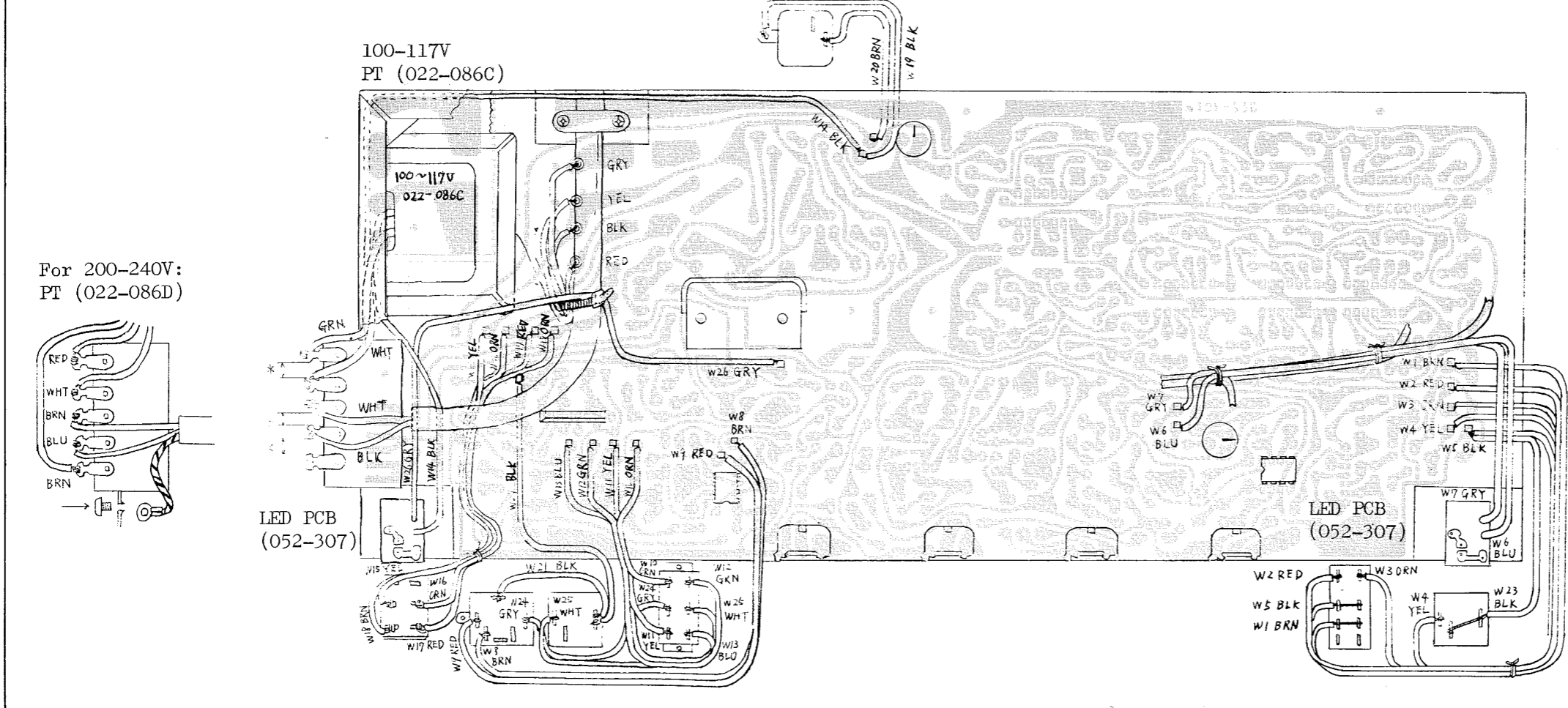
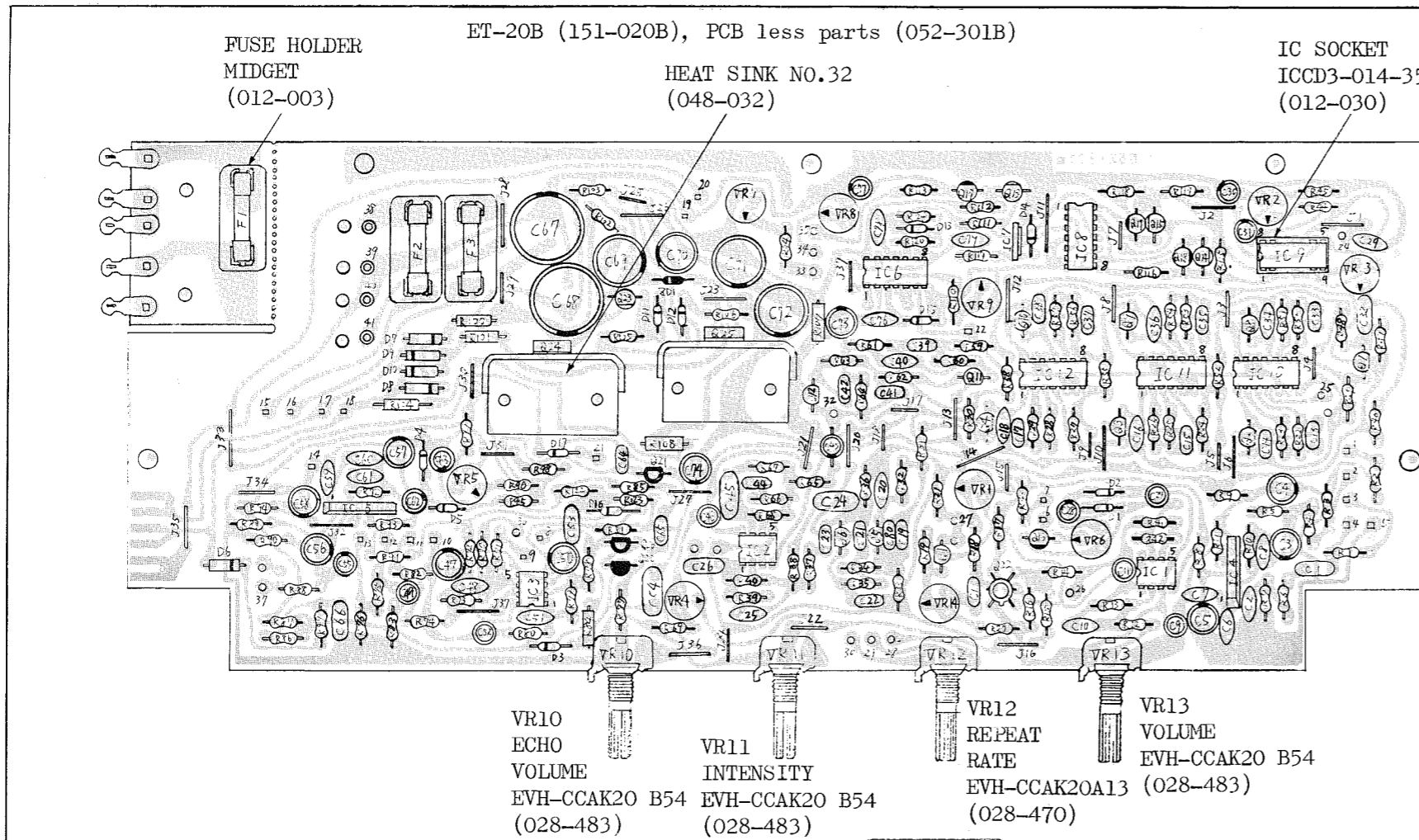

Power Transformer
Secondary Voltage
55V_{p-p} (20V RMS)
(38-39; 40-41)

Input (-20dB Range)
1KHz, -25dB
(Except B)
1KHz, -25dB, -15dB
(Only B)

REPEAT RATE
Setting Position

ET-20B (151-020B)

FUSE HOLDER
MIDGET
(012-003)

HEAT SINK No.32
(048-032)

3P TYPE. (Others jumped)

IC SOCKET
ICCD3-014-350T
(012-030)

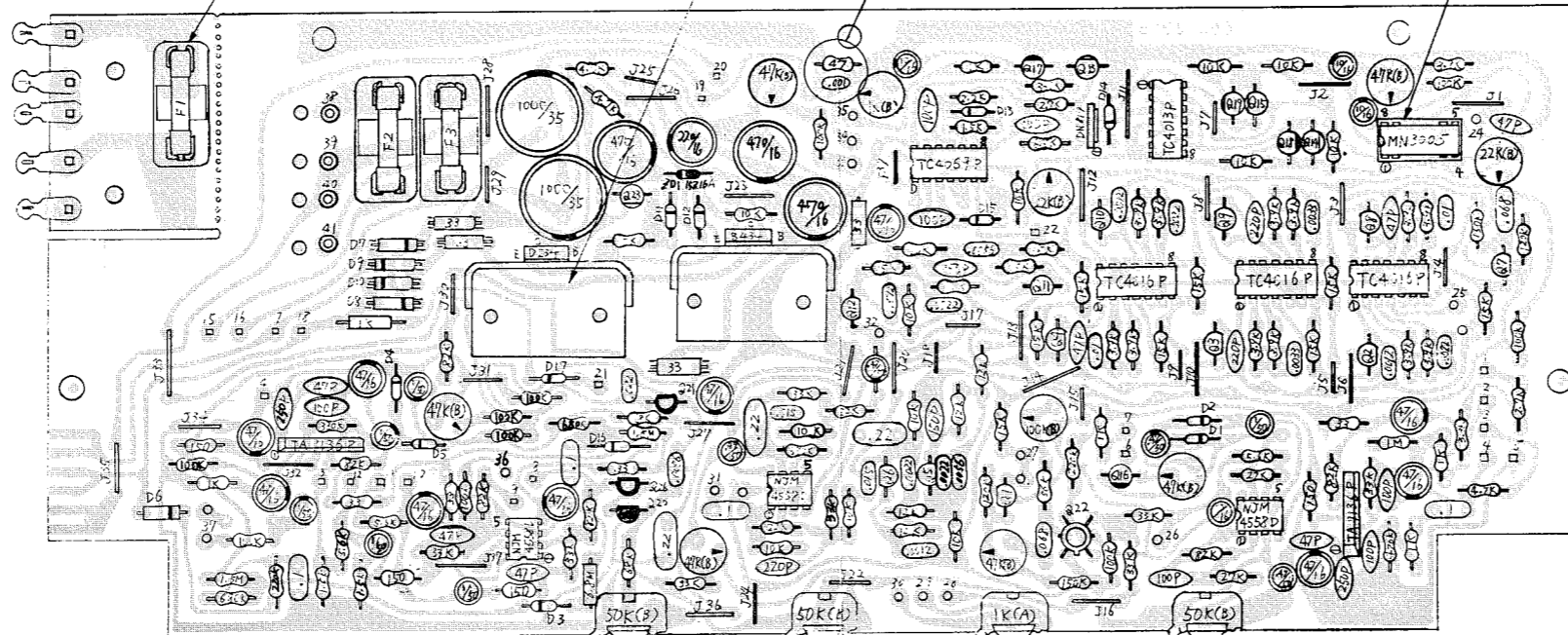

TOP VIEW

- Q1-12: 2SC900 F or 2SC100 GR
- Q13-15: 2SC1740 R or 2SC828 R
- Q16-19: 2SA826 Q or 2SA564 A
- Q21, 26: 2SK44D or 2SK30A Y
- Q20: 2SK30A Y
- D1-5, 11-17: 1S2473 or 1S1555
- D6-10: 1N4003
- ZD1: 05Z16A
- Q22: E412 (ITS30546)

FUSE	F1	F2, 3
100/117/117-3P	SGAO.5A (008-024)	SGAO.5A (008-024)
220/240-J/240	CEE100mAT (008-056)	CEE250mAT (008-060)

- VR10
ECHO
VOLUME
50KB
EVH-CCA K20B54
(028-483)
Or
VM10R50K BK20
(028-576)
- VR11
INTENSITY
50KB
EVH-CCA K20B54
(028-483)
or
VM10R50K BK20
(028-576)
- VR12
REPEAT
RATE
1KA
EVH-CCA K20A13
(028-470)
or
VM10R1K AK20
(028-572)
- VR13
VOLUME
50KB
EVH-CCA K20B54
(028-483)
or
VM10R50K BK20
(028-576)

ET-20B (151-020B) does not contain potentiometers VR10 - 13.

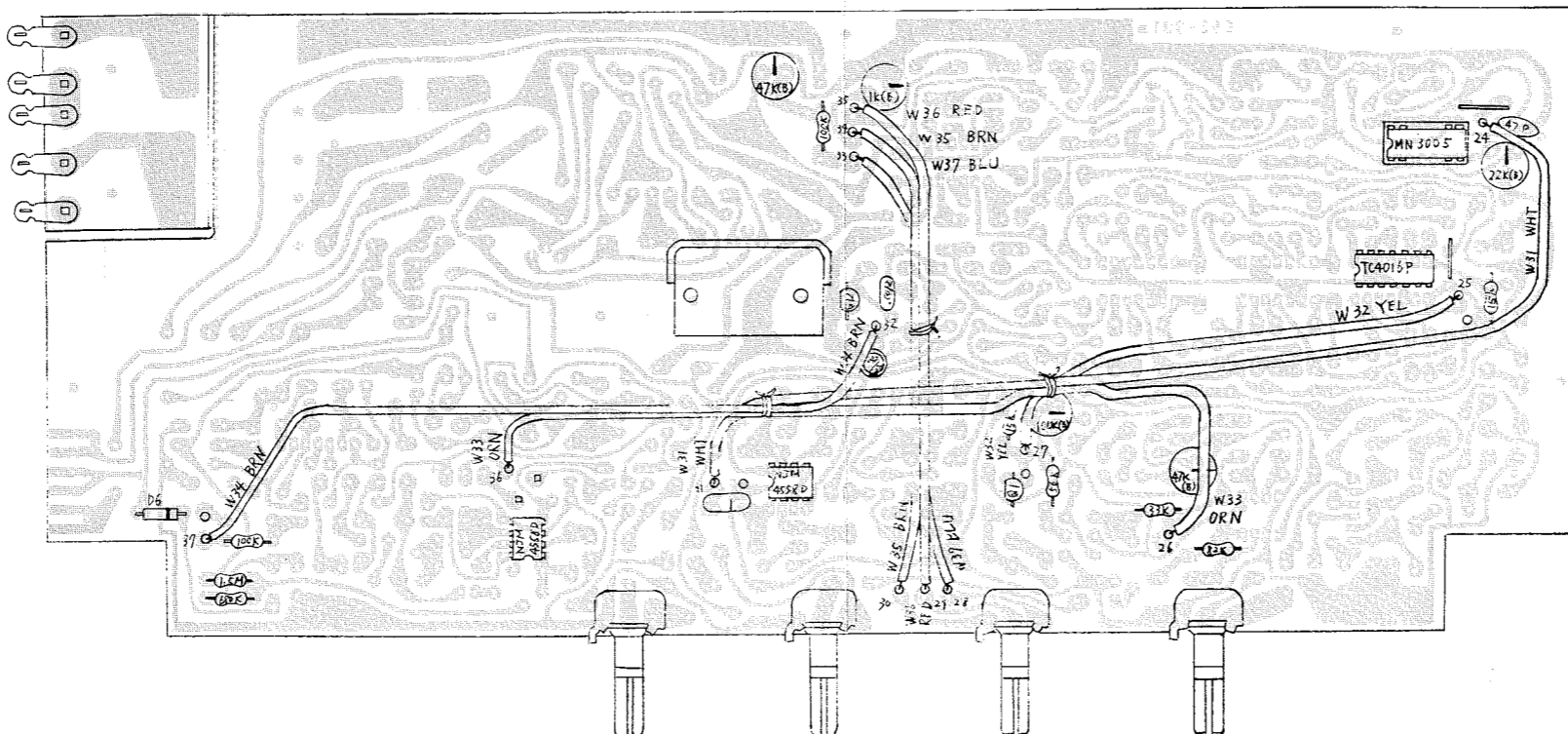

TC4013P

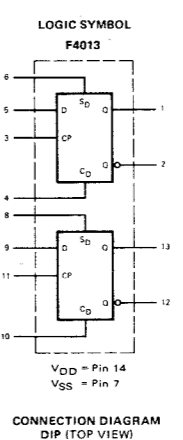

TC4016P

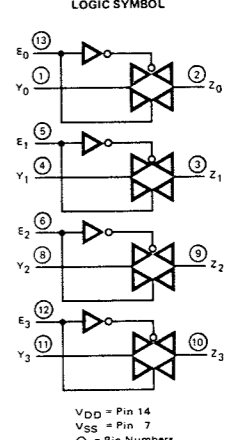

TC4069P

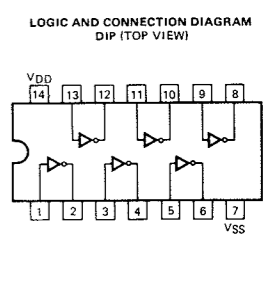

ET-20B' (SERIAL NO.651700 - 682499)

PCB less parts (052-301B)

When replacing, use ET-20B (151-301B).
 ET-20B does not contain potentiometers VR10-13.

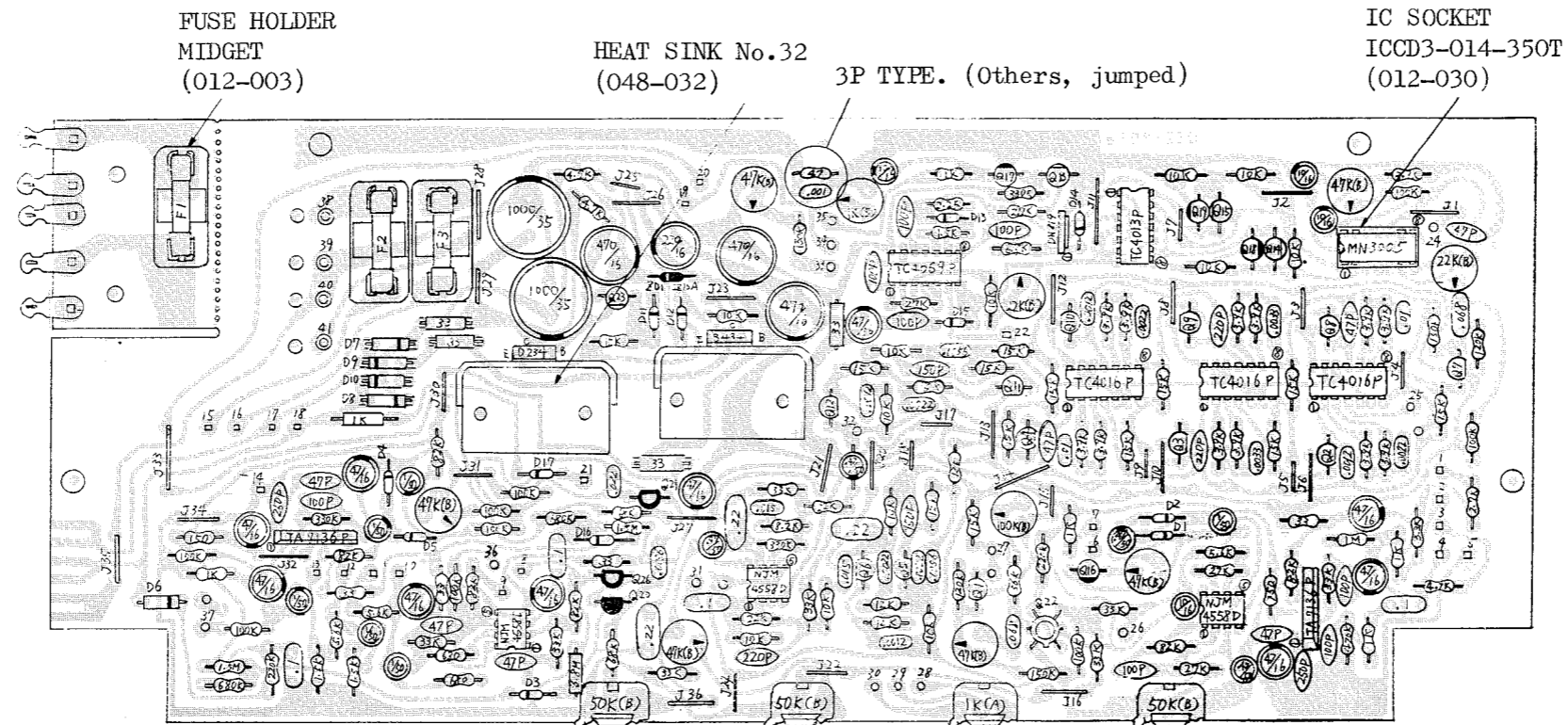

- | | | | |
|--|--|--|---|
| VR10
ECHO VOLUME
EVH-CCA K20B54
(028-483)
or
VM10R50K BK20
(028-576) | VR11
INTENSITY
EVH-CCA K20B54
(028-483)
or
VM10R50K BK20
(028-576) | VR12
REPEAT
RATE
EVH-CCA K20A13
(028-470)
or
VM10R1K AK20
(028-572) | VR13
VOLUME
EVH-CCA K20B54
(028-483)
or
VM10R50K BK20
(028-576) |
|--|--|--|---|

- Q1-12: 2SC900 F or 2SC1000 GR
- Q13-15: 2SC1740 R or 2SC828 R
- Q16-19: 2SA826 R or 2SA564A R
- Q21,26: 2SK44D or 2SK30A Y
- Q20: 2SK30A Y
- D1-5, 11-17: 1S2473 or 1S1555
- D6-10: 1N4003
- ZD1: 05Z16A
- Q22: E412 (ITS30546)

The circuit diagram for ET-20B' is the same as that of ET-20B except that R74 and R80 are involved in the IC3a and 3b loops. See ET-20A circuit diagram.

GENERAL ADJUSTMENT

1. ADJUSTING CLOCK GENERATOR FREQUENCY

a) Input: No

Repeat Rate: MAX

Connect oscilloscope vertical input lead to lead wire of the resistor R116 (10K-ohm) as shown at the right. Set the Clock Generator frequency at 100KHz (10usec) by adjusting the trimmer pot VR7.

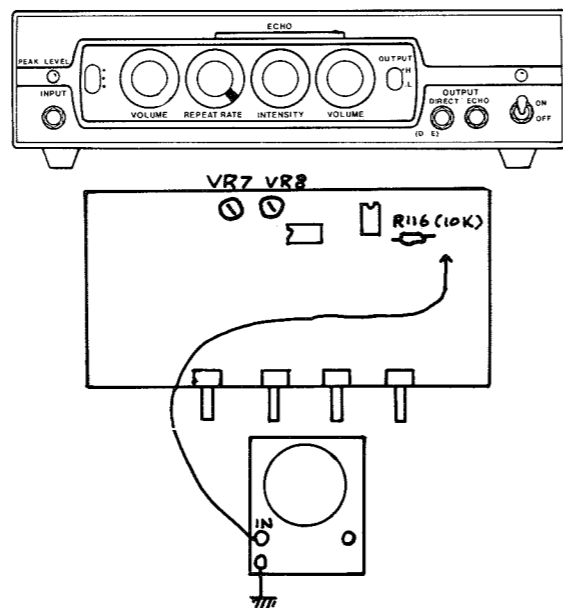
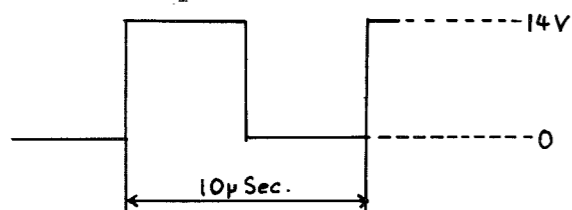

b) Input: No

Repeat Rate: MIN

Connect oscilloscope input lead in the same way as (a). Set the Clock Generator frequency at 5KHz (200usec) by adjusting the trimmer pot VR8.

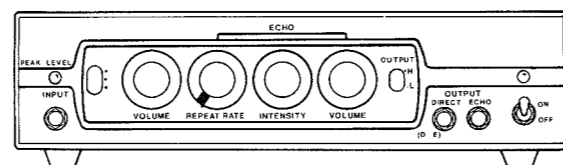
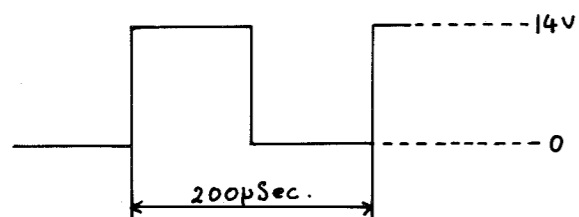

Repeat a) and b) until both frequencies are adjusted correctly.

2. ADJUSTING ONE-SHOT PULSE WIDTH

Input: No

Repeat Rate: MIN

Connect oscilloscope vertical input lead to Pin No.22 and trigger input lead to lead wire of D13.

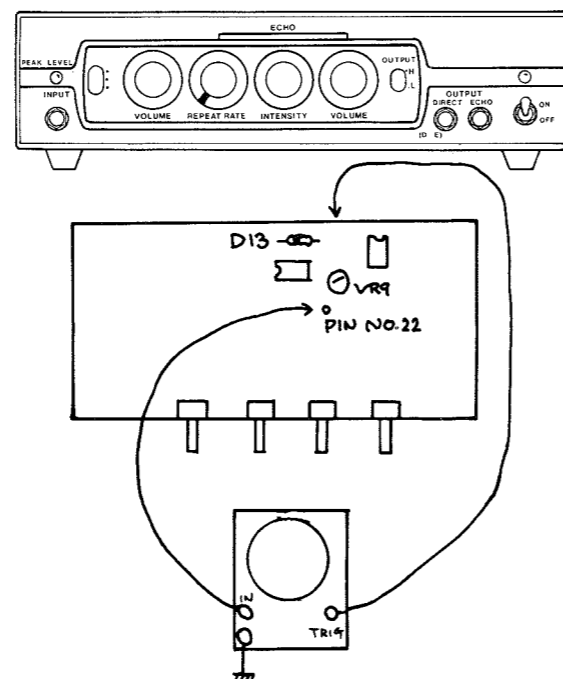
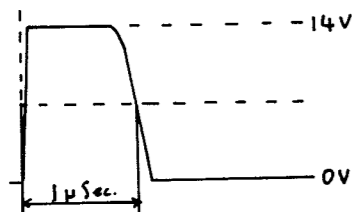

Set one-shot pulse width to 1 usec at the center of the amplitude by adjusting the trimmer VR9.

Note: 1) DC-10 of Serial No. 640100 to 651699

Note that the one-shot pulse width may change a little by connecting horizontal lead. One-shot pulse width becomes bigger by turning Repeat Rate control from Min to MAX slowly. Make sure that the maximum width is within 1.3usec.

3. ADJUSTING PEAK LEVEL INDICATOR

Volume: MAX

Intensity: MIN

Input Level: -20dB

Input: 100mV (-20dBV) Sine wave, 1KHz
Set the trimmer pot VR6 so that the Peak Level Lamp is about to light.

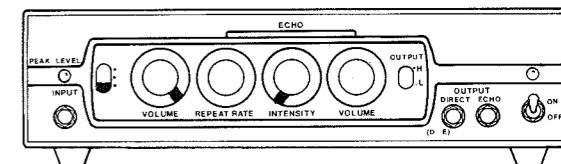

4. ADJUSTING LIMITER

Be sure to turn the trimmer pot VR14 fully clockwise before adjusting.

Volume: Max

Intensity: Min

Input Level: -50dB

Input: 100mV (-20dBV) Sine wave, 1kHz
Connect oscilloscope input lead to the base of transistor Q1. Adjust the trimmer pot VR1 so that the waveform voltage is 2.5Vp-p.

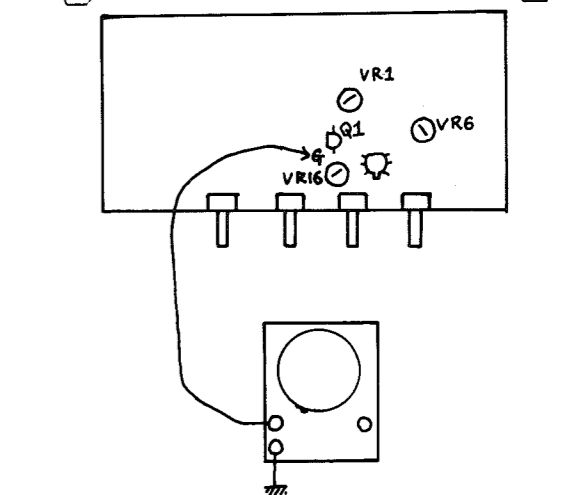
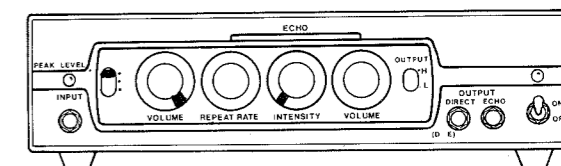
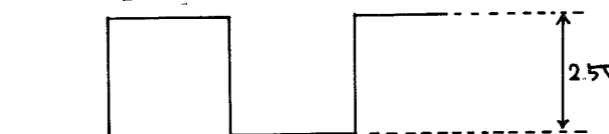

5. ADJUSTING BBD BIAS VOLTAGE

Volume: Max

Repeat Rate: 5

Intensity: Min

Input Level: -20dB

Input: 100mV (-20dBV) sine wave, 1KHz
Connect oscilloscope input lead to the lead wire of resistor R46 (100k). Adjust the trimmer pot VR2 so that the waveform does not clip at the top and the bottom.

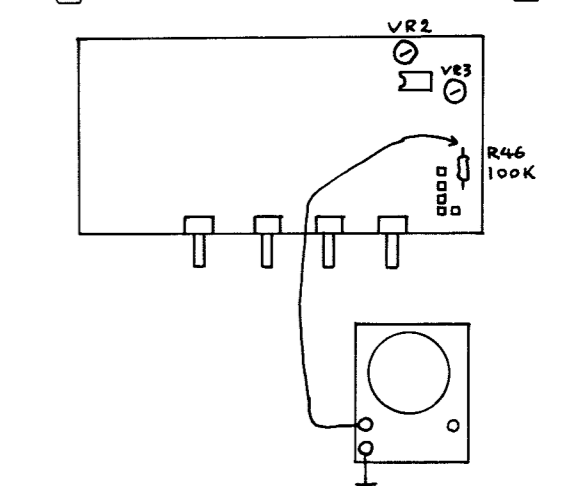
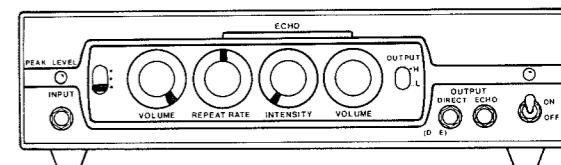

If the waveform clips so heavily that adjustment with VR2 is not enough, adjust trimmer pot VR14.

When VR14 is turned, 2.5V of 4) adjusting limiter, will change, which may be overlooked.

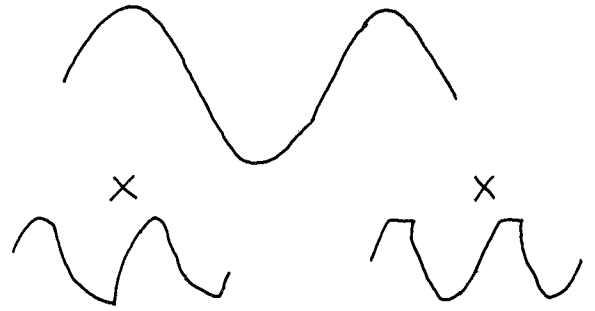

6. ELIMINATING CLOCK PULSE IN BBD OUTPUT
(ADJUSTING BBD BALANCE)

Input: No.

Repeat Rate: MIN

Intensity: MIN

Connect oscilloscope input lead to the lead wire of resistor R46 (100K). Adjust the trimmer pot VR3 to obtain waveform as (2) below.

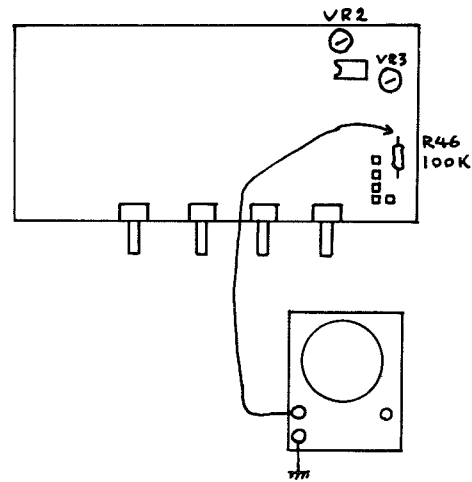
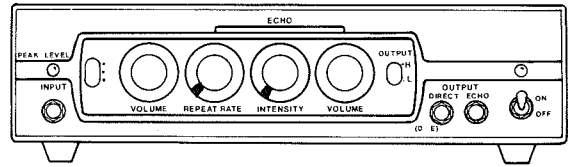
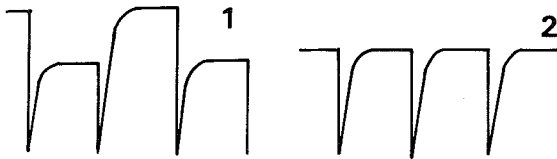

7. ADJUSTING NOISE KILLER

Input: No

Intensity: MIN

Echo Volume: MAX

Repeat Rate: 5

Output Level: H

Connect an amplifier to Echo Output. Turn the trimmer pot VR5 full clockwise. While listening to noise from the amplifier, turn the trimmer pot counterclockwise gradually until the noise level falls suddenly.

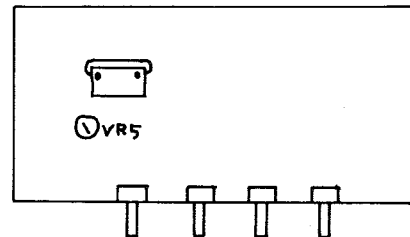
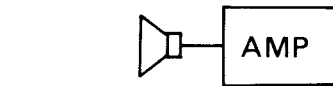
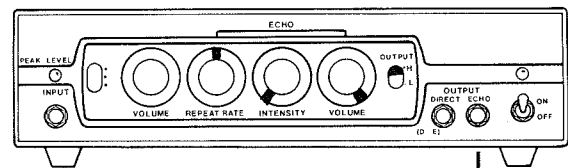

8. ADJUSTING INTENSITY

Input: No

Repeat Rate: 5

Echo Volume: MAX

Output Level: L

Connect an amplifier to either of Output jacks.

Set Intensity control at 8 and adjust the trimmer pot VR4 so that self-oscillation continues. Return Intensity control to 7.5 and make sure that the oscillation comes to end smoothly.

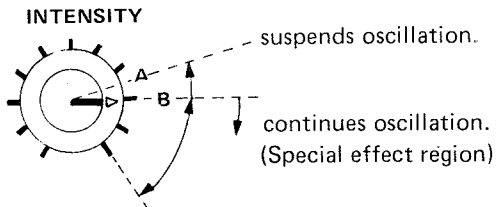
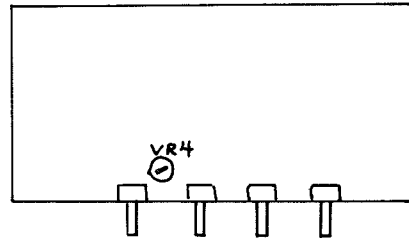
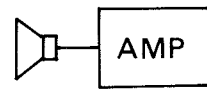
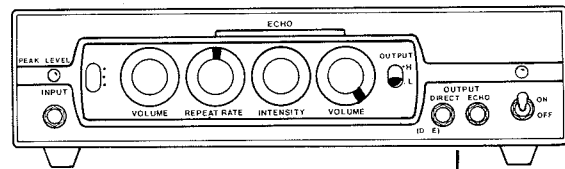

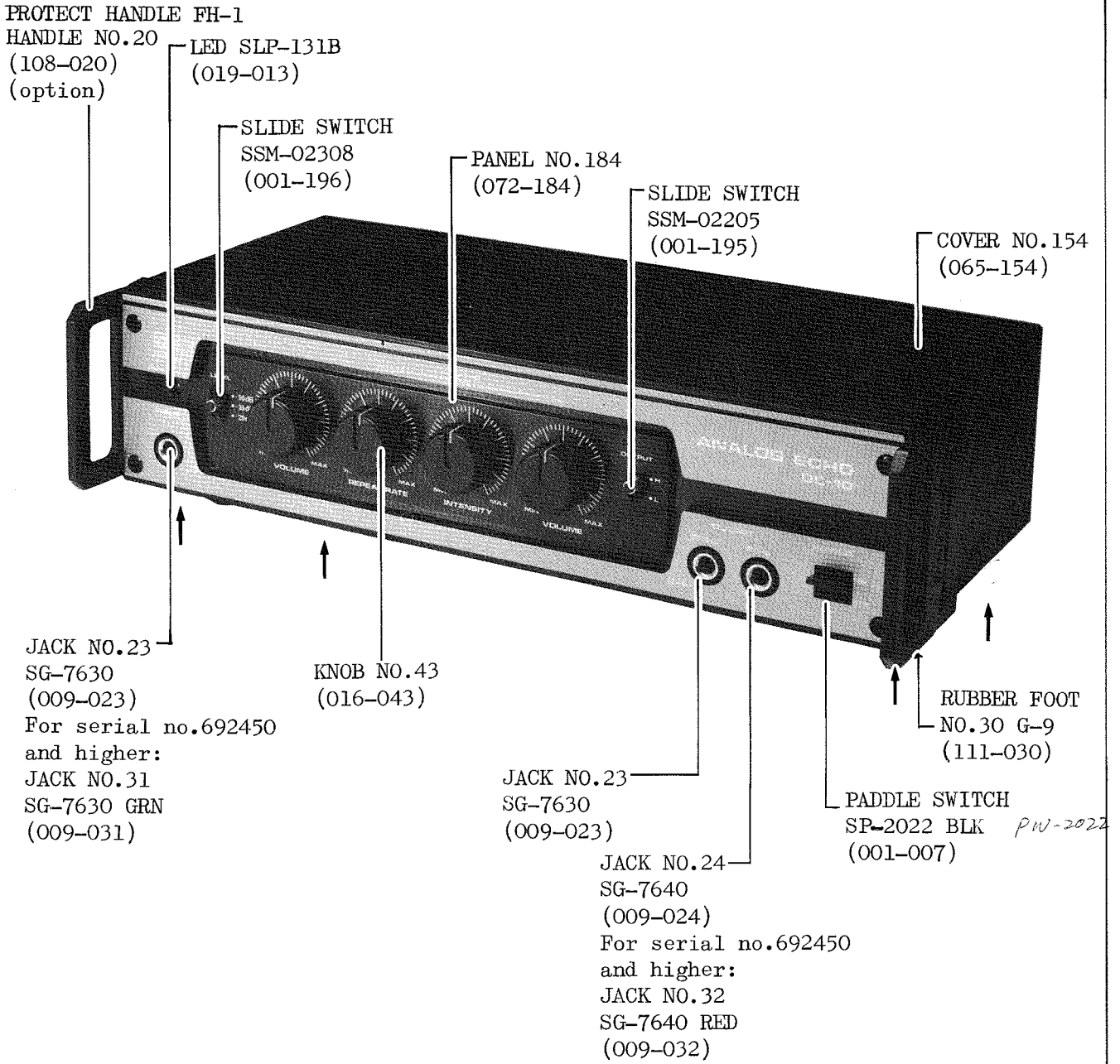

To disassemble COVER NO.154, remove FOUR SCREWS (binding head screw, 4 x 8, BR) at the bottom (marked with arrow). Four screws at the sides (binding head screw, 4 x 8, BR) need not be removed for disassembling the cover.

REAR PANEL

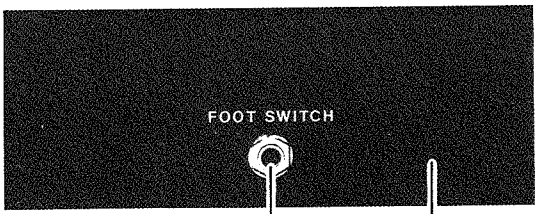

PANEL NO.193
(072-193)

JACK NO.1
SG-7615 NO.5
(009-001)

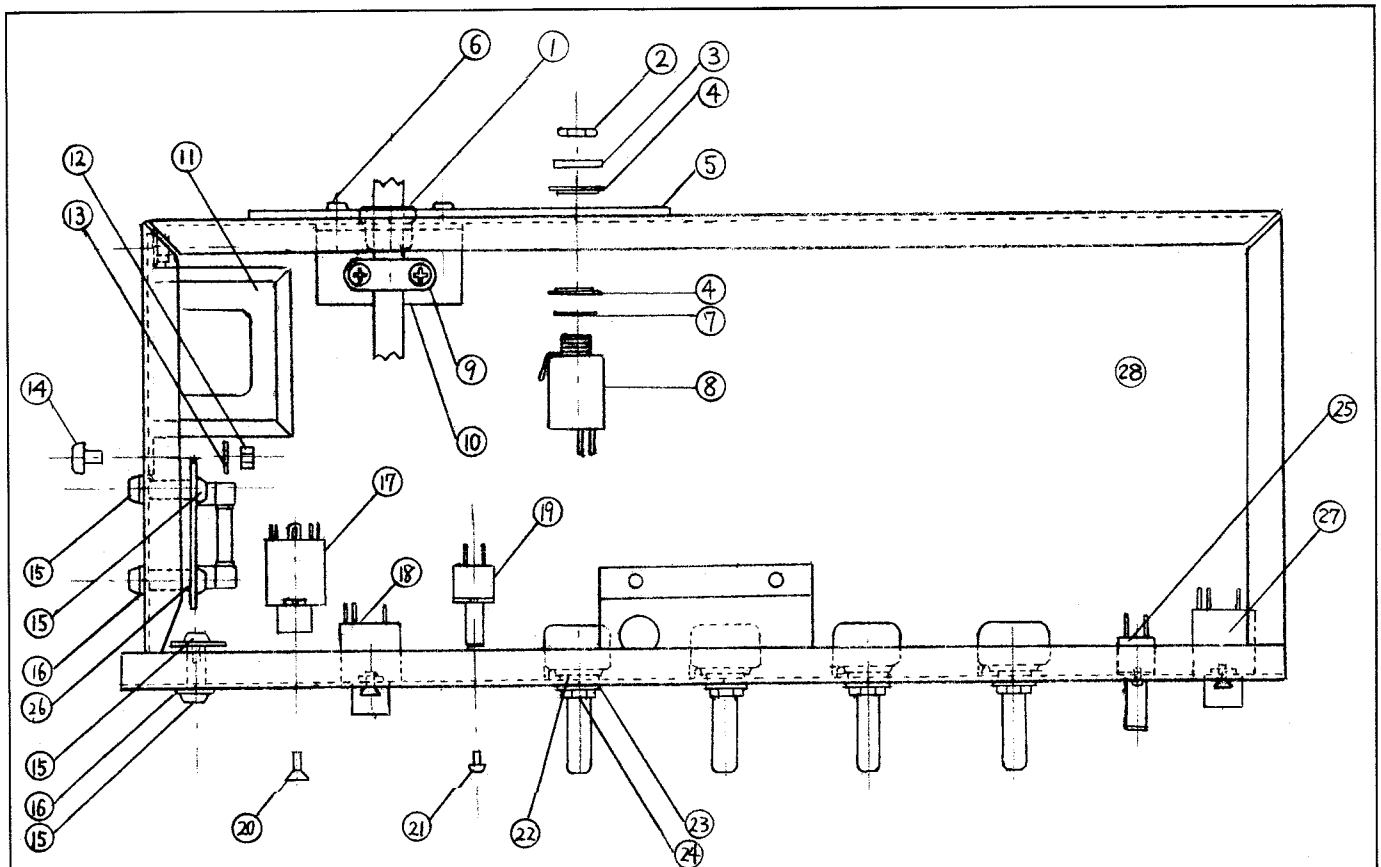

NO.	PART NO.	PART AND DESCRIPTION	NO. USED
1	047-003	Line Cord Strain Relief, BU-4801	1
2		Jack Nut, included in Jack	1
3	121-005	Jack Washer No. 5	1
4	068-005	Insulating Bush No.5	2
5	072-193	Rear Panel, Panel No. 193	1
6		Binding Head Screw, 3 x 6, Fe	2
7		Washer, included in Jack	1
8	009-001	Jack No. 1, SG-7615 No. 5	1
9	047-023	Cord Clamp, No. 1702B	2
10	064-134	Holder, No. 134	1
11	022-086C	Power Transformer, 100/117V	1
	022-086D	Power Transformer, 200/220/230/240V	1
12		Nut, M4, Fe	2
13		Spring Washer, M4, Fe	2
14		Binding Head Screw, 4 x 8, Fe	2
15		Binding Head Screw, 3 x 6, Fe	8
16		Spring Washer, M3, Fe	4
17	009-024	Jack No. 24, SG-7640	1
	009-032	Jack No. 32, SG-7640 (Red), Serial No. 692450 and higher	1
18	009-023	Jack No. 23, SG-7630	1
19	001-195	Slide Switch, SSM-02205	1
20		Flat Head Screw, 3 x 6, Fe	6
21		Pan Head Screw, 2 x 3, Ni	4
22		Washer, included in Potentiometer	4
23	120-002	Potentiometer Washer, No. 2, t=1	4
24		Potentiometer Nut, included in Potentiometer	4
25	001-196	Slide Switch, SSM-02308	1
26	120-001	Sleeve Nut, No. 1, 10mm	4
27	009-023	Jack No. 23, SG-7630	1
	009-031	Jack No. 31, SG-7630(Green), Serial No. 692450 and higher	1
28	061-182	Chassis, No. 182	1

PART NO.	PART AND DESCRIPTION	PART NO.	PART AND DESCRIPTION
065-154	Cover No.154		Potentiometers
111-030	Rubber Foot, G-9	028-483	EVH-CCAK20B54 K20 50KB <i>EVH 6PA 361 B54</i>
130-198	Carton No.198	(028-576)	(VM10R50KB K20) <i>EVH 2CAP 20B 54</i>
151-020B	ET-20B Assy	028-470	EVH-CCAK20A13 K20 1KA
	Interchangeable with ET-20A		Serial No. 681200 and higher
052-301B	ET-20B PCB less parts	(028-572)	(VM10R1KA K20)
052-307	PCB, LED mounting	028-573	VM10R1KB K20 1KB
072-184	Panel No.184, Front		Serial No. Up to 672099
072-193	Panel No.193, Rear	030-459	SR19R 1KB (EVTR4A/EVLR4X), trimmer
061-182	Chassis No.182	030-467	SR19R 22KB (EVTR4A/EVLR4X), trimmer
		030-469	SR19R 47KB (EVTR4A/EVLR4X), trimmer
016-043	Knob No.43	030-471	SR19R 100KB (EVTR4A/EVLR4X), trimmer
001-007	Lever Switch <i>SP-2022</i> , Black, Power <i>PW-2022 k 30EL</i>		Capacitors
001-195	Slide Switch SSM-02205, 2P, Output	032-070	ECEA 50VR47 50V 0.47u electro.
001-196	Slide Switch SSM-02308, 3P, Input	032-071	ECEA 50V1 50V 1u electro.
009-001	Jack No.1 SG-7615-No.1, Footswitch	032-033	ECEA 16V10 16V 10u electro
009-023	Jack No.23, SG-7630, D+E	032-036	ECEA 16V47 16V 47u electro.
	Input, Serial No. Up to 682449	032-038	ECEA 16V220 16V 220u electro.
009-031	Jack No.31 SG-7630 Green, Input	032-040	ECEA 16V470 16V 470u electro.
	Serial No. 692450 and higher	032-069	ECEA 35V1000 35V 1000u electro.
009-024	Jack No.24 SG-7640, Echo Out	032-193	ECEA50NR47 50V 0.47u bi-polar
	Serial No. Up to 682449	032-190	ECEA50N1 50V 1u bi-polar
009-032	Jack No.32 SG-7640, Red, Echo Out	032-191	ECEA16N10 16V 10u bi-polar
	Serial No. 692450 and higher		Resistors
065-164	Cover No.164, Felt, Slide Switch	044-108	ERC-12GK 33-ohm 1/2W, solid carbon
120-001	Sleeve Nut No.1, 10mm	044-114	ERC-12GK 1K 1/2W, solid carbon
012-003	Fuse Holder TF-758, Midget	044-597	ERC-12GK 6.8M 1/2W, solid carbon
012-030	IC Socket ICC03-014-350T		1/4W resistors and mylar capacitors are omitted.
048-032	Heatsink No.32		() indicates substitutive parts.
022-086C	Power Transformer 100/120V		
022-086D	Power Transformer 220/240V		
008-024	Fuse SGA-0.5A, Midget, 100/120V		
008-056	Fuse CEE-100mA, Midget, Prim. 220/240V		
008-060	Fuse CEE-250mA, Midget, Sec. 220/240V		
064-134	Holder, No.134, Line Cord		
047-023	Cord Clamp 1702B		
047-003	Line Cord Strain Relief BU-4801		
	Semiconductors		
020-085	MN-3005 BBD		
020-084	TC-4069P IC <i>TC 4069 WP 7 4 11</i>		
020-083	TC-4016F IC <i>BP TC-4016 BP 0 4 11</i>		
020-041	TC-4013P IC		
020-039	DN-819 IC		
020-027	TA-7136P IC		
020-064	(NJM)NEC-4558D IC		
017-061	2SK44D FET		
017-036	E-412 (ITS-30546) FET		
017-014	2SK30A Y FET		
017-097	2SA826 Q		
017-022	2SB434 O		
017-098	2SC-1740 R		
017-021	2SC900 F		
017-010	2SD234 O		
018-022	1N4003 Diode		
018-014	1S2473 Diode		
018-026	05Z-16A Zener		
019-013	SLP-131B LED red		

PARTS ORDERING INFORMATION

Name of part number of some of the parts is changed from those printed on previously issued parts list. When ordering replacement parts, be sure to follow the description on the present issue.

When ordering parts, be sure to include the following information:

1. Model and Serial Number
2. Part Number
3. A Description of the Part

This parts list includes all standard stock replacement parts. No attempt has been made to include every nut, bolt and screw. If the necessity for a non-listed part arises, please write describing the parts location and function as well as model and serial number of the unit.

