

COMBO PIANO

MP-700

INSTRUCTIONS

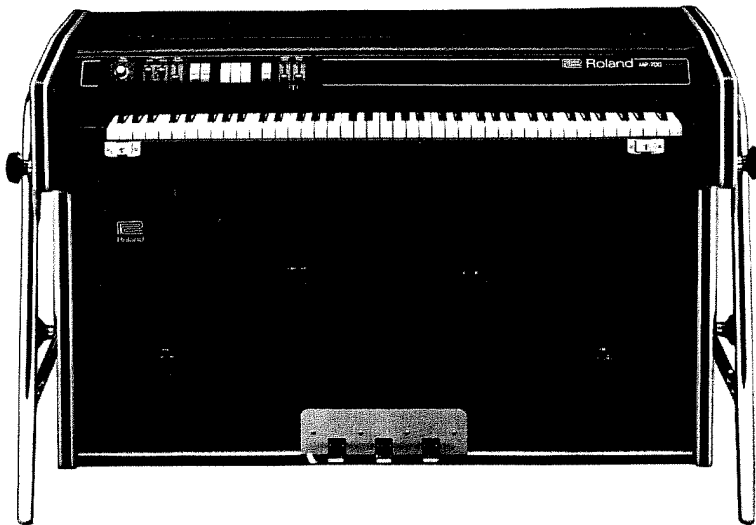

MP-700 employs an LSI electronic generator system in the sound source and a hammering key action. Your performance is guaranteed at a stabilized pitch at any place, with no need of re-tuning. A variety of performance modes and rugged construction of MP-700 will fully satisfy the requirements of professional keyboard players. This is a new type electronic piano designed for you.

Please read these instructions carefully for proper connection and operation, and enjoy your own piano playing.

MPA-100 is a 120W rms amplifier for MP-700. It includes rich functions to make the best use of varied sounds of MP-700.

MP-700 PART NAME AND FUNCTION

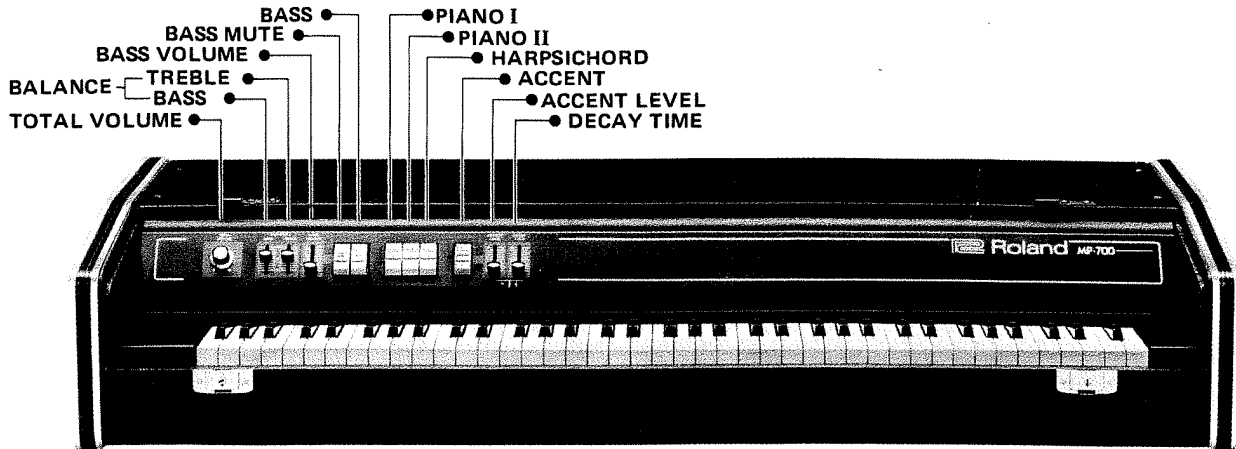

●**TOTAL VOLUME** controls total volume. Turn clockwise (↻) to increase, and counterclockwise (↺) to decrease.

* At extreme counterclockwise (↺) position, volume is nullified.

●**PRESET TABLETS** set the basic sound from MP-700. Depress lower end to set a tablet to ON. Each tablet can be used individually. Free combination of tablets is also possible.

PIANO I mellow piano sound

PIANO II bright piano sound

HARPSICHORD harpsichord sound

●**ACCENT** gives percussive tone when a key is struck. Depress lower end of tablet to set ON. This can be used both in combination with preset tablets and also performance with this tablet alone is possible.

* For this tablet, the decay time is short.

●**ACCENT LEVEL** controls volume of harmonics component at time of accent effect. When the knob is lifted gradually from "0" to "10", accent

volume increases and sound with larger harmonics content is obtained. At "0" position, accent volume is minimized. (not completely nullified.)

●**BASS** produces sound like a bass guitar from two lower octaves (♭). By depressing lower end of the tablet, this effect goes into action.

* When BASS and ACCENT tablets are used and BASS VOLUME is decreased, only accent sound is produced.

●**BASS MUTE** changes the BASS sound to that of a double bass sound, by combined use with BASS tablet.

* Depressing BASS MUTE tablet only does not produce the sound.

* When BASS MUTE is in action, ACCENT effect is not obtained from the two lower octaves (♭).

●**BASS VOLUME** controls volume of lower registers when BASS tablet is used. When lifted, the volume increases and when lowered, it is decreased.

* When the knob is set at "0", BASS sound is not produced.

●**BALANCE** controls tone balance of lower and higher registers to accord with amplifier response and the purposes of performance.

* **TREBLE** and **BASS** controls change the level of higher and lower range respectively with C5 as the approximate center.

TREBLE controls volume of higher range. When lifted over center "0", the volume is increased and when lowered, decreased. The center position gives flat sound.

BASS controls volume of lower range. When lifted over center "0", the volume is increased and when lowered, decreased. The center position gives flat sound.

●**DECAY TIME**: When a key is struck, the volume immediately reaches its peak and gradually decays with pass of time. This knob controls the time. When the knob is lifted, the decay time becomes longer and when lowered it becomes shorter.

MP-700 CONNECTION PANEL

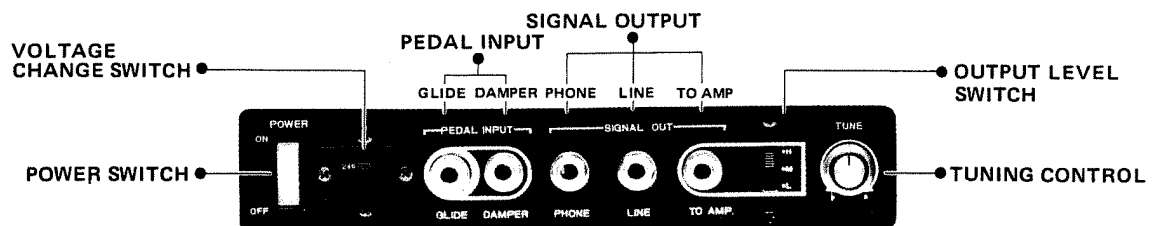

●**POWER SWITCH**: Built-in pilot lamp is combined.

●**PEDAL INPUT**: Connect Pedal Output of MPA-100 or DP-10 (GLIDE-DAMPER PEDAL) to this jack.

●**SIGNAL OUT**

TO AMP . . . Connect this jack to MPA-100 or other amplifiers. Output level can be changed to three steps with Signal Output Level Switch.

LINE . . . This is a LINE-OUT jack. Can be connected to a mixer or a tape deck to record your performance.

PHONE . . . This is a jack to connect a stereo headphone.

●**VOLTAGE CHANGE SWITCH**: MP-700 provided with this switch can be switched to operate at 220V or 240V. Set to proper position. Models without the switch operates at 110V thru 120V.

●**TUNE** controls pitch of entire notes. When turned clockwise (↻), the pitch becomes higher and counterclockwise (↺), it becomes lower. This is very convenient when you hope to match the pitch to other instruments. (Approx. 30 cents for A-442Hz)

MPA-100 PART NAME AND FUNCTION

The amplifier MPA-100 contains two channel main amplifier/speaker system (25cm x 4) to produce natural chorus and vibrato effects and can produce a wide range of sounds, delicate, refined tone to dynamic, powerful sound. Handling three pedals gives you wider variations of performance.

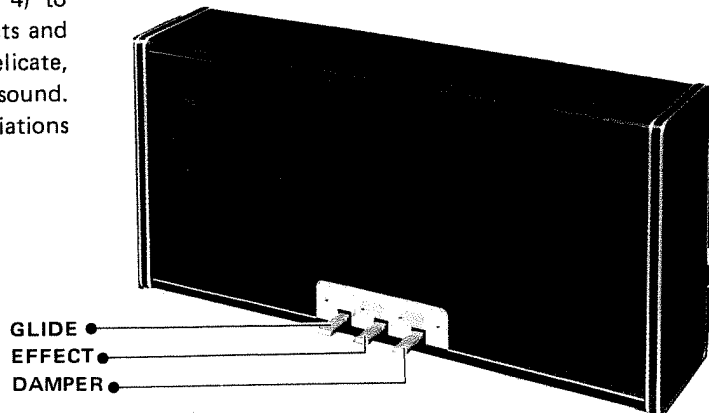

- **DAMPER:** While this pedal is trod down, normal damping function is cancelled, to sustain the sound.
- **EFFECT:** This pedal switches chorus or vibrato effect to ON or OFF. To obtain chorus effect, set Chorus/Vibrato switch on connection panel to Vibrato. When this pedal is trod

(kept trod down or released immediately), chorus effect goes into action. Treading again cancels the effect and returns to normal sound. To obtain vibrato effect, set Chorus/Vibrato switch on connection panel to Vibrato. When this pedal is trod (kept trod or released immediately), vibrato effect

goes into action. Treading again cancels the effect and returns to normal sound.

- **GLIDE:** While this pedal is trod down, musical intervals of all keys are glided down by a chromatic interval (100 cents). When released, the intervals gradually returns to original condition.

MPA-100 CONNECTIN PANEL

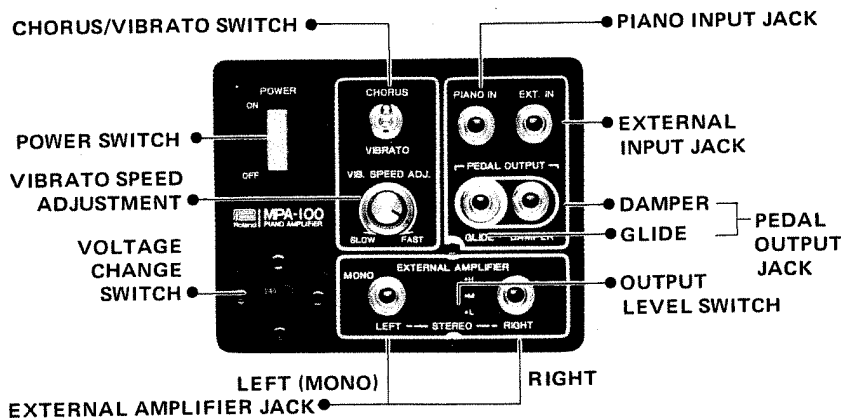

- **POWER SWITCH:** Built-in Pilot Lamp is combined.

● **CHORUS/VIBRATO SWITCH:** Effect added on MP-700 sound is switched to Chorus or Vibrato by this switch. When set to Chorus, the effect goes ON/OFF by treading Effect pedal (center). When set to Vibrato, the Vibrato effect goes ON/OFF by treading Effect pedal (center).

● **VIB SPEED ADJ:** This controls vibrato speed. Turning clockwise (◻) makes the speed faster and counterclockwise (◻), slower.

● **PIANO IN:** This jack receives signal output from MP-700 "TO AMP."

● **EXT IN:** This jack receives outputs from other Roland instruments like synthesizer, strings, rhythm, etc. Chorus/Vibrato effect cannot be added on the instrument connected to this jack.

● **PEDAL OUT:** This jack connects to Pedal Input of MP-700.

● **EXTERNAL AMPLIFIER:** If you hope to produce a big sound, on a large stage, for example, bigger output amplifiers can be driven through this jack. By using the stereo outputs, external amplifiers can be connected both to L and R outputs. When using a single output, connect to L output. (With R output alone, effects cannot be added.)

● **VOLTAGE CHANGE SWITCH:** MPA-100 provided with this switch can be switched to operate at 220V or 240V. Set to proper position. Models without the switch operates at 110V thru 120V.

MPA-100 REAR PANEL



● **VIBRATO DEPTH:** Vibrato depth can be controlled freely by this knob. Turning clockwise (◻) gives deeper vibrate and counterclockwise (◻), slight vibrato.

● **CHORUS SPEED:** This knob controls chorus speed. Turning clockwise (◻) produces faster chorus and counterclockwise (◻), slower.

● **AC OUTLET:** Connect AC plug of MP-700. (110/120V type only)

● **FUSE**

* Vibrato depth and chorus speed are factory-set to optimal positions. Do not move them unless specifically necessary. Only when unavoidable, turn it with a screwdriver, etc.

DP-10 PART NAME AND FUNCTION

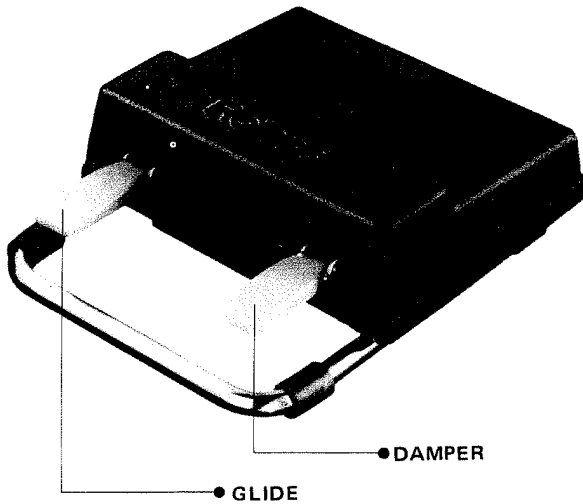

This is a foot pedal for MP-700 equipped with damper and glide pedals. When you don't use piano amplifier MPA-100, damper and glide effects can be obtained by operating the pedals.

- DAMPER:** While this pedal is trod down, normal damping function is cancelled, to sustain the sound.
- GLIDE:** While this pedal is trod down, musical intervals of all keys are glided down by a chromatic interval (100 cents). When released, the intervals gradually return to original condition.

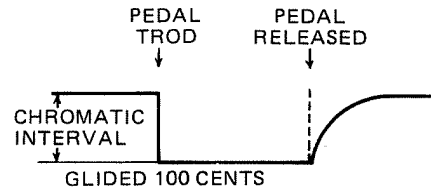

AN EXAMPLE OF SETTING MP-700 & DP-10

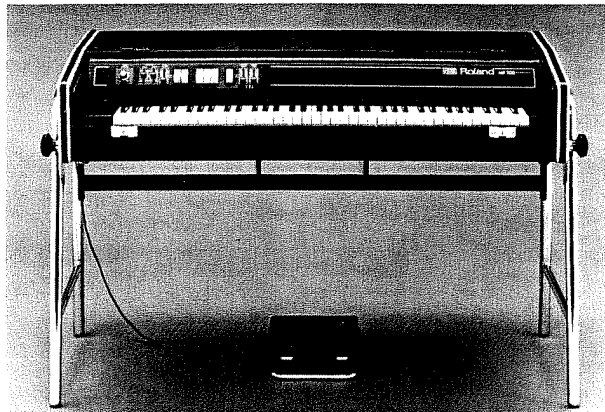

A NOVEL EFFECT - ACCENT

With an acoustic piano, a big component of harmonics are contained immediately after a key is struck. The harmonics component gradually decays and the sound becomes soft. To actualize this acoustic piano character, MP-700 involves a novel function —

ACCENT, which will greatly enhance the performance variation.

The accent effect will be best demonstrated when a note is struck *mezzo forte* thru *fortissimo*.

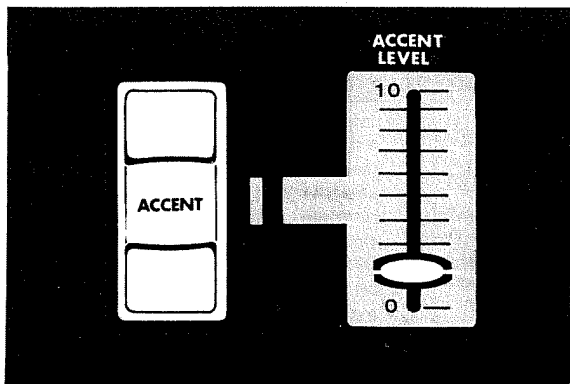

ACCENT SECTION OF MP-700 CONTROL PANEL

ACCENT is great for ROCK & JAZZ sounds.

By maneuvering Accent tablet and Accent level, you can freely produce a variety of sounds: percussive sound with quick response at time of striking and soft sound. By combining together with other sounds tablet, you can enjoy wider variations of performance.

APPLICATIONS OF ACCENT EFFECT

If you perform with PIANO I and ACCENT tablets ON, for example, sound with high level of harmonics component is produced immediately after a key is struck. Then the sound gradually changes to tone of

PIANO I with fundamental component as the main. Further the intensity of the effect is freely controlled by Accent Level.

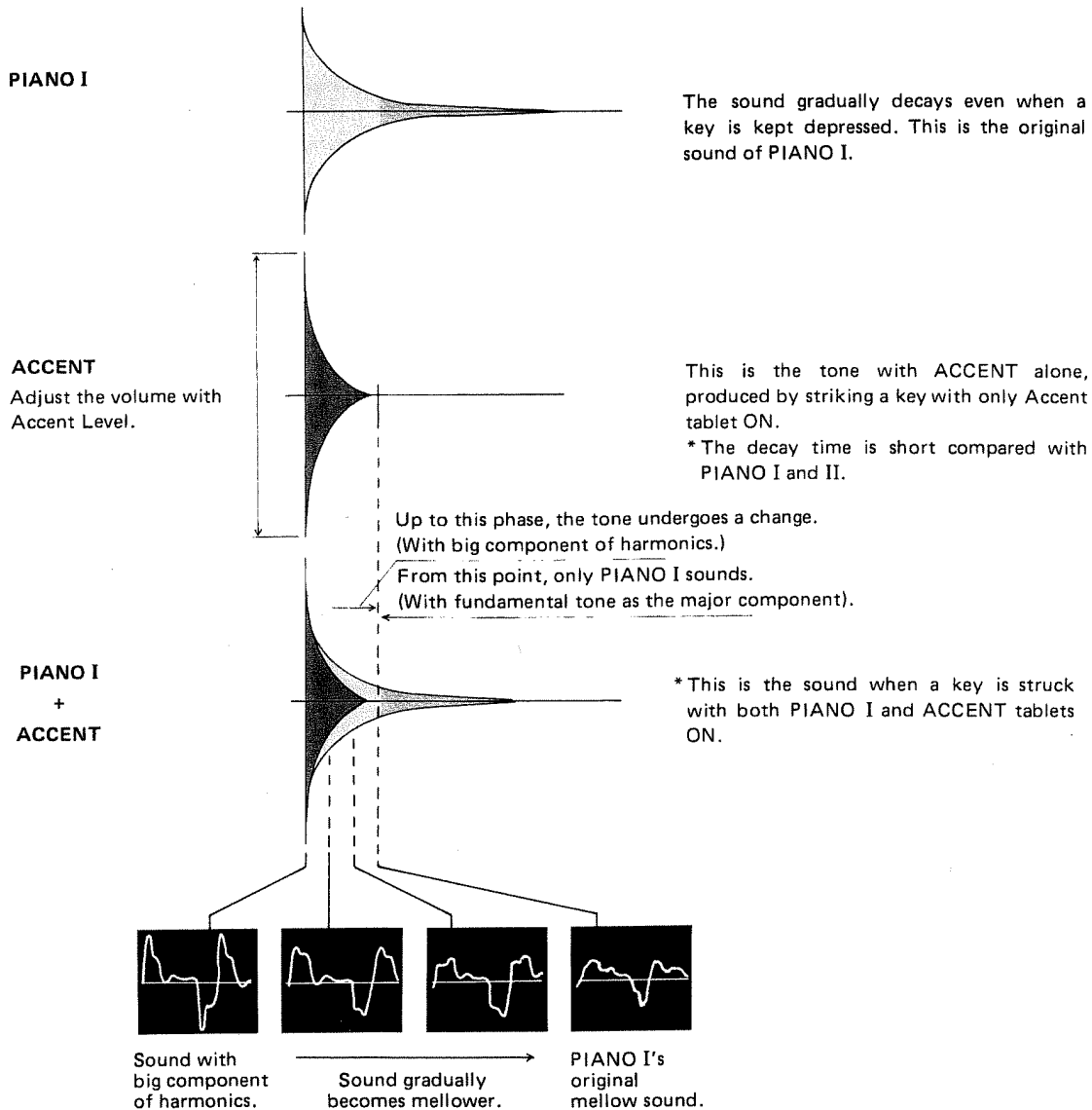

NOTE 1

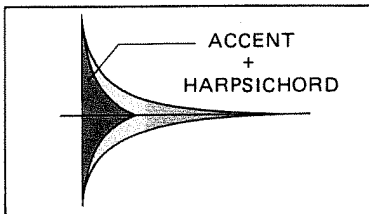

●COMBINATION OF ACCENT AND HARPSICHORD

Immediately after a key is struck, Accent sound and Harpsichord sound are produced simultaneously, which is harpsichord sound with many harmonics plus piano-like accent. When Accent decays, original harpsichord sound is obtained.

NOTE 2

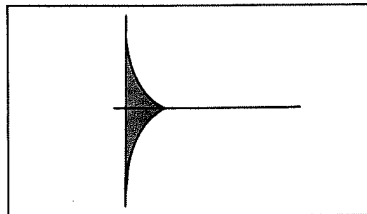

●DISTORTION

When Accent Level is set to maximum, distortion will occur at time of striking a key. If the distortion is undesirable, set the Accent Level to proper position to avoid that.

NOTE 3

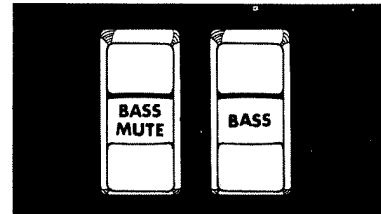

●BASS MUTE

When both BASS and BASS MUTE tablets are depressed, Accent effect does not function for two lower octaves (♯), producing soft sound of BASS MUTE. With BASS set at ON and BASS MUTE at OFF, Accent functions to produce effective bass sound.

ASSEMBLING

MP-700 + MPA-100

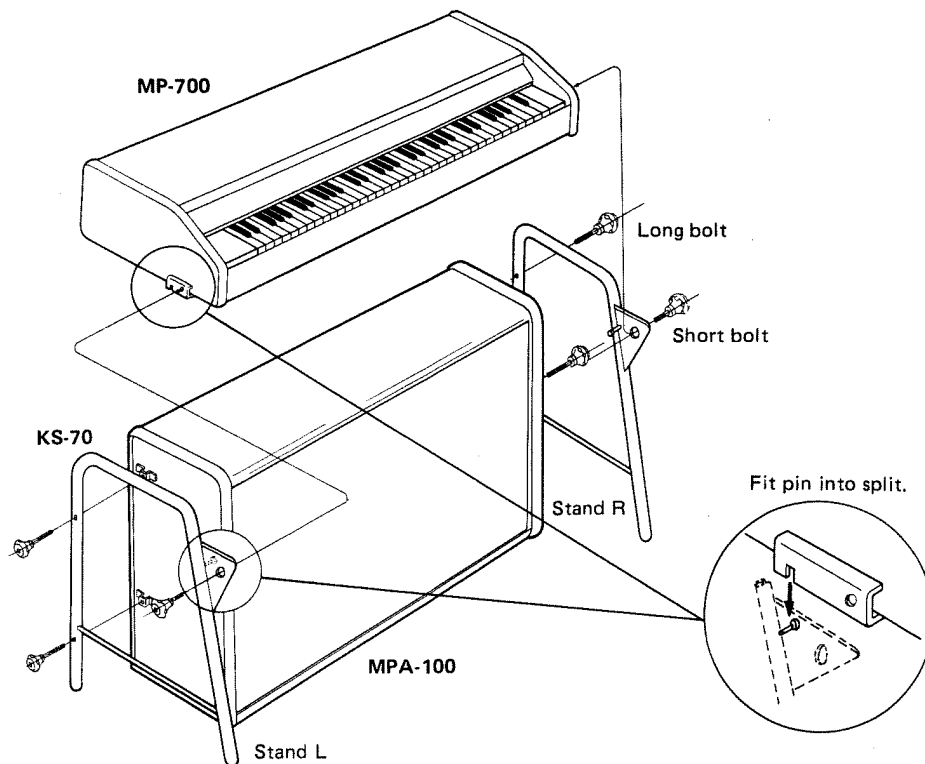

MP-700 + DP-10

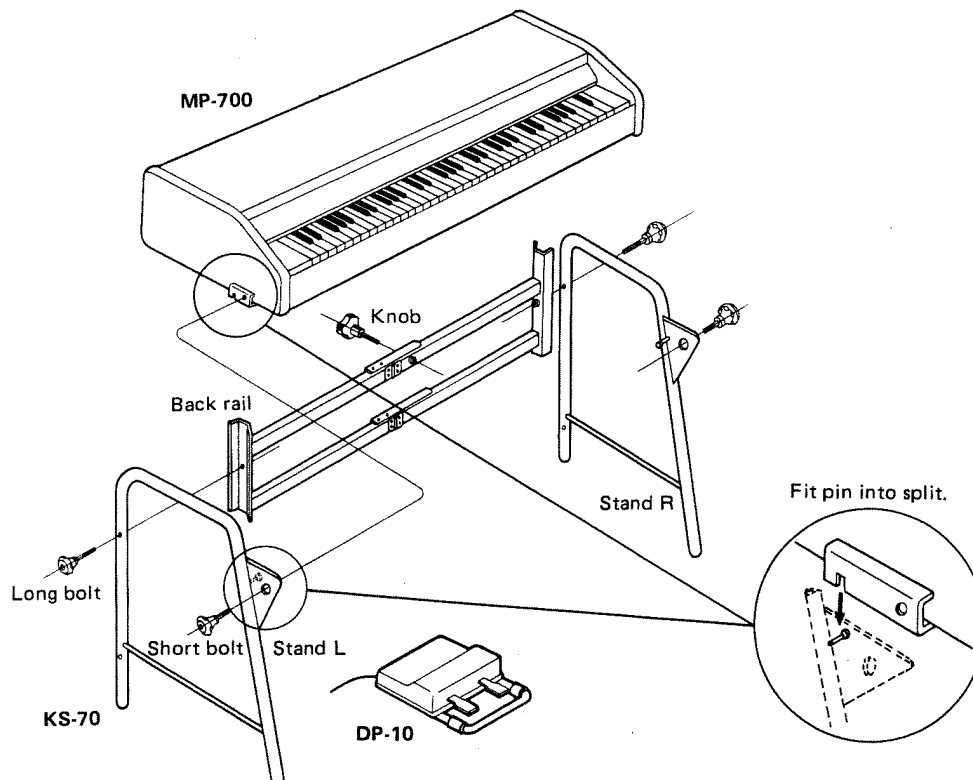

BASIC CONNECTION MP-700 + MPA-100 or DP-10

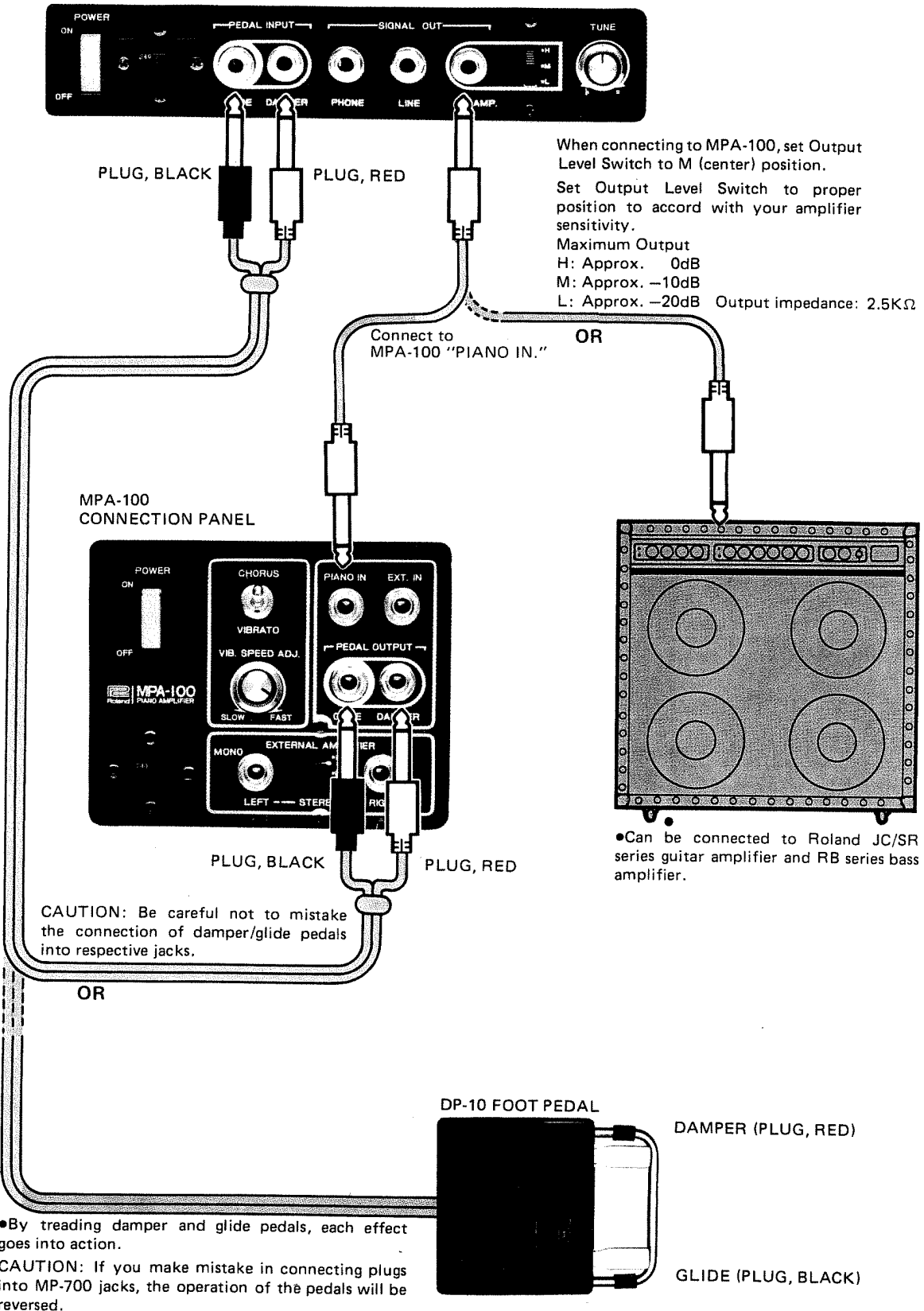

APPLIED CONNECTION AUXILIARY INPUTS AND OUTPUTS

MP-700 CONNECTION PANEL

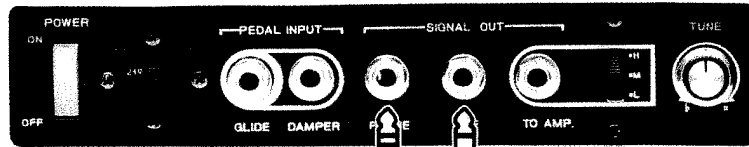

Roland stereo headphone (RH-1) option



Output impedance: 8Ω, approx. 200mW

●Can be connected to other devices. It is possible to connect to a mixer or a tape deck to record your performance.
Maximum output: approx. -10dB
Output impedance: 20KΩ

With this connection, chorus and vibrato cannot be effected.
Allowable input: approx. 0dB

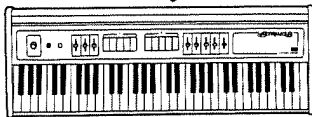

Roland Strings RS-202

OR



Can be connected to other Roland instrument like SH series synthesizer.

MPA-100 CONNECTION PANEL



TO LINE IN

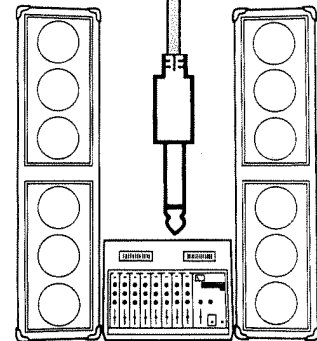

Connect to Line-In of Roland PA mixer and others.

●When used as monaural, connect to LEFT output jack.

Connect to Revo Sound Systems.

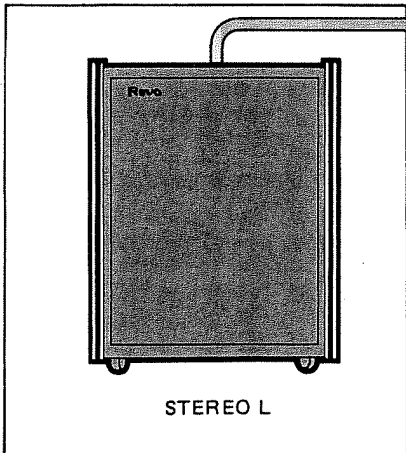

STEREO L

For Chorus effect, Revo Sound Systems placed apart will give you wide dispersion, stereophonic effect, which will greatly help create rich sounds.

* If very big sound is required or when wider dispersion of chorus is desirable, connect to external amplifiers from these jacks.

●Maximum output level
H: 0dB
M: -12dB
L: -24dB
Impedance: approx. 600Ω

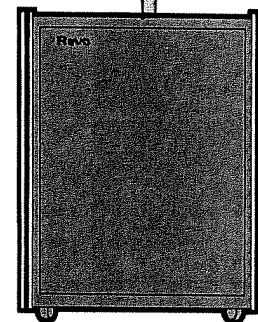

STEREO R

MP-700 PLAYING GUIDE

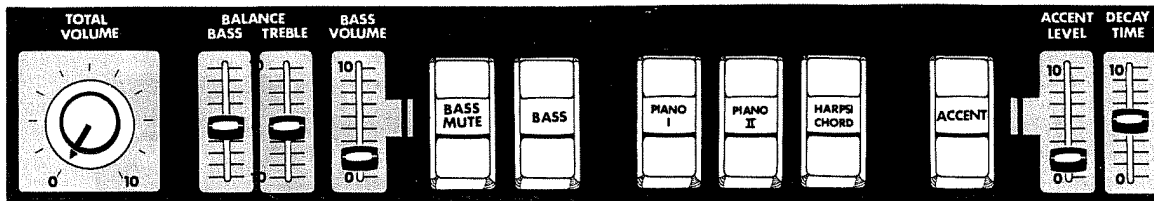

1. Connect all necessary cords and then set knobs and tablets as illustrated above.
2. Make sure that power switches of MP-700 and MPA-100 are set to OFF. Plug in AC mains cord into outlet.
3. Now MP-700 is ready for playing.
4. Set power switches of MP-700 and MPA-100. Pilot lamps will light.

TO PLAY PIANISSIMO EFFECTIVELY

Dynamic range of MP-700 becomes wider as Total Volume is set higher. When Total Volume is set at higher positions, therefore, pianissimo and fortissimo sounds are effectively obtained. On the other hand, if Total Volume is set at lower positions, at "2" for example, there is only a slight difference between pianissimo and fortissimo playing, because the fortissimo sound itself is restricted by the Total Volume control. Thus, it is recommended to set Total Volume over "5" and adjust Output Level Switch to proper position where adequate volume is produced when played with normal intensity.

•TO OBTAIN PIANO I (mellow jazz sound)

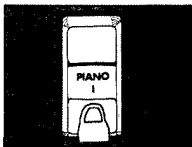

1. Set PIANO I tablet to ON.

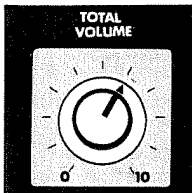

2. Turn Total Volume knob clockwise (↻) to produce proper volume.
* Even if a key is struck without turning Total Volume, no sound is produced.
3. Strike keys. PIANO I sound is produced.

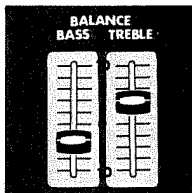

4. Turn Balance knobs — Treble and Bass — to obtain tone you like.

CAUTION: If Bass tablet is set to ON and Bass Volume is set at Minimum, no sound is produced from two lower octaves (♯) at all. Set Bass Volume knob to proper position to produce bass sound of proper level.

•TO OBTAIN PIANO I PLUS ACCENT EFFECT

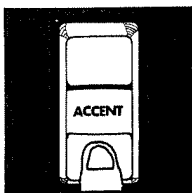

5. After steps 1 — 4 for PIANO I playing, set Accent tablet to ON.

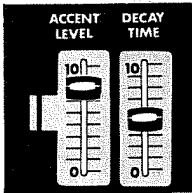

6. Lift Accent Level knob to produce proper accent volume.
7. Now PIANO I + ACCENT sound is produced.

CAUTION: If Accent Level knob is set to Maximum, the produced sound may be distorted. Set Accent Level knob to proper position to avoid that, if not desirable.

* For other sound tablets — PIANO II and HARPSICORD — follow the same steps as 1 — 4 for PIANO I playing.

•TO OBTAIN BASS SOUND (STEADY BASS SOUND) FROM TWO LOWER OCTAVES (♯)

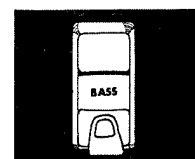

1. Set Bass Tablet to ON.



2. Set Bass Volume and Total Volume knobs to proper level.
3. Strike keys on two lower octaves. BASS guitar sound is produced.
4. Turn Balance knobs — Treble and Bass — to obtain the tone you like.

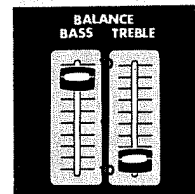

CAUTION 1: If preset tablets and Accent tablet are set to OFF, two lower octaves (♯) produces sounds, however, no sound is produced from other keys even when they are struck.

CAUTION 2: If Total Volume is turned to Minimum, with Bass Volume lifted, no sound is produced even when a key is struck. Set Total Volume knob to proper position to produce sound.

•TO OBTAIN BASS GUITAR SOUND WITH STRONG ATTACK

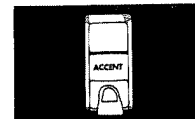

5. After steps 1 — 3 for BASS SOUND playing, set Accent tablet to ON.

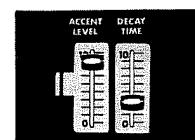

6. Lift Accent Level knob to proper position.
7. Strong attack bass sound is produced.
8. Adjust tone controls in the same way as step 4 for BASS SOUND playing.

•TO OBTAIN SOFT DOUBLE BASS SOUND

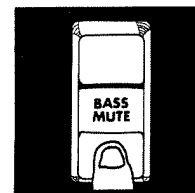

9. After steps 1 — 3 for BASS SOUND playing, set BASS MUTE tablet to ON.
10. Double bass sound is produced.
* At this setting, Accent cannot be effected even when Accent tablet is set to ON.
11. Adjust tone controls in the same way as step 4 for BASS SOUND playing.

HOW TO USE MPA-100 FOOT PEDAL

1. After connecting cords, set three foot pedals as instructed by arrow A in the illustration on the left (Fig. 1). Fig. 2 shows the foot pedal positions.

2. Now the pedals can be operated.

*When you don't use foot pedals, turn them back as instructed by arrow B (Fig. 1).

•To familiarize yourself with the function of the foot pedals, set PIANO I tablet on MP-700 Control Panel to ON and turn Total Volume to clockwise (⊙) to proper position. Try to tread each pedal and strike keys.

* See "TO OBTAIN PIANO I SOUND" on page 8.

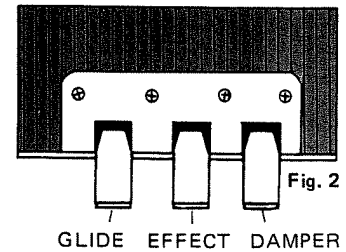
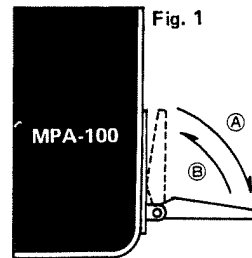

•DAMPER PEDAL

1. Tread this pedal to effect sustain over all keys.
2. To cancel the effect, release damper pedal.

•EFFECT PEDAL

A. TO OBTAIN CHORUS EFFECT



1. Set CHORUS/VIBRATO SWITCH to CHORUS.
2. Now, chorus is ready to be effected.

3. While in playing, tread the effect pedal.
* The effect is obtained both by (1) treading and releasing immediately, and (2) treading and keeping treading.
4. To turn back to normal sound, tread down the effect pedal again.

B. TO OBTAIN VIBRATO EFFECT



5. Set CHORUS/VIBRATO SWITCH to VIBRATO.
6. Now, vibrato is ready to be effected.

•COMBINED USE OF PRESET TABLETS AND RESULTING SOUND

The sound tablets can be quickly switched even while in performance. Varied sound can be produced to meet your program and performance.

TABLET	SOUND
PIANO I	Mellow jazz sound
PIANO II	Steady rock sound
HARPSICHORD	Brilliant harpsichord sound
PIANO I + ACCENT	Novel piano sound upon which accent effect is best demonstrated. Sound is suited for slow and soft solo performance.
PIANO II + ACCENT	Strong attack piano sound with well-demonstrated accent effect. By lifting treble control, the sound is for hard rock playing.

•You can freely set combinations of preset tablets other than those listed above.

It is also possible to delicately control the sound with balance



7. While in playing tread the effect pedal, in the same way as step 3.

8. To make vibrato speed faster, turn Vibrato Speed Adjustment knob clockwise (⊙) and set it at proper position.

9. To turn back to normal sound, tread down the effect pedal again.

•GLIDE PEDAL

1. While in playing, tread down Glide Pedal.
2. The musical intervals of all keys are glided down by a chromatic interval.
* If you continue playing with glide pedal down, sound remains glided.
3. To turn back to normal intervals, release Glide Pedal.
* True value of glide pedal is demonstrated by repeated treading and releasing during performance.

CAUTION:

Damper and glide cannot be effected properly if connection with MP-700 is imperfect. Be sure to connect perfectly. If you make mistake in connecting plugs into MP-700 jacks, the operation of the pedals will be reversed. (See "Basic Connection" on page 6.)

TABLET	SOUND
PIANO I + HARPSICHORD + ACCENT	Clavichord sound. With this, accent effect is slightly moderated.
PIANO I + HARPSICHORD + ACCENT + CHORUS	Honky-tonk piano sound.
BASS	Steady bass guitar sound.
BASS + BASS MUTE	Mellow double bass sound.
BASS + ACCENT	Strong attack bass guitar sound.

control by treble and bass, decay time control, foot pedal of MPA-100, etc.

TROUBLESHOOTING GUIDE

If your units do not operate properly, take proper action consulting the table below. The symptoms below would be caused by mistake in using the unit. If the trouble cannot

be remedied even after the actions instructed, or if there is any symptom other than those listed below, call for our serviceman.

MP-700

SYMPTOM	POSSIBLE CAUSE	ACTION TO BE TAKEN
Even when power switch is set ON, pilot lamp does not light and striking key does not produce sound.	Imperfect connection of power cord.	Plug in power cord perfectly.
Pilot lamp lights, but striking key does not produce sound.	Connection to amplifier is imperfect. Total Volume is set to minimum.	Connect perfectly. (See "Basic Connection" on page 6.) Turn knob clockwise (⌚) to produce proper volume.
Sound rustles.	Cord connection is imperfect. Cord is defective.	Connect cords firmly. Replace cord.
Pitch does not match to other instruments.	Tuning is imperfect.	Tune correctly.
When connected to external amplifier, output is too big or too small.	Output level is not matched.	Set Output Level Switch to proper position to accord with the amplifier you use.

MPA-100

Even when power switch is set ON, lamp does not light and no sound is produced.	Imperfect connection of power cord. Fuse is blown.	Plug in power cord perfectly. Replace a new fuse. (110/117V, 5A; 220-240V, 3.15A)	
Foot Pedal Section	Damper is inoperative.	Jack connection is imperfect. Connect firmly.	
	Glide is inoperative.	Pedal jack connection is reverse. Connect correctly.	
	Effect is inoperative. *Chorus effect is inoperative. *Vibrato effect is inoperative.	Jack connection is imperfect. Chorus/Vibrato switch is set to Vibrato. Chorus/Vibrato switch is set to Chorus.	Connect firmly. Change to Chorus. Change to Vibrato.
	When connected to external amplifier, output is too small.	Jack connection is imperfect. Output level is not matched.	Connect firmly. Set Output Level Switch to proper position to accord with the amplifier you use.

DP-10

Glide pedal is inoperative. Damper pedal is inoperative.	Pedal jack connection is imperfect.	Connect firmly.
Glide and Damper operate with opposite pedals.	Pedal jack connection is reverse.	Connect correctly.

MP-700 NOTES

Changes to steady bass sound with BASS tablet ON.

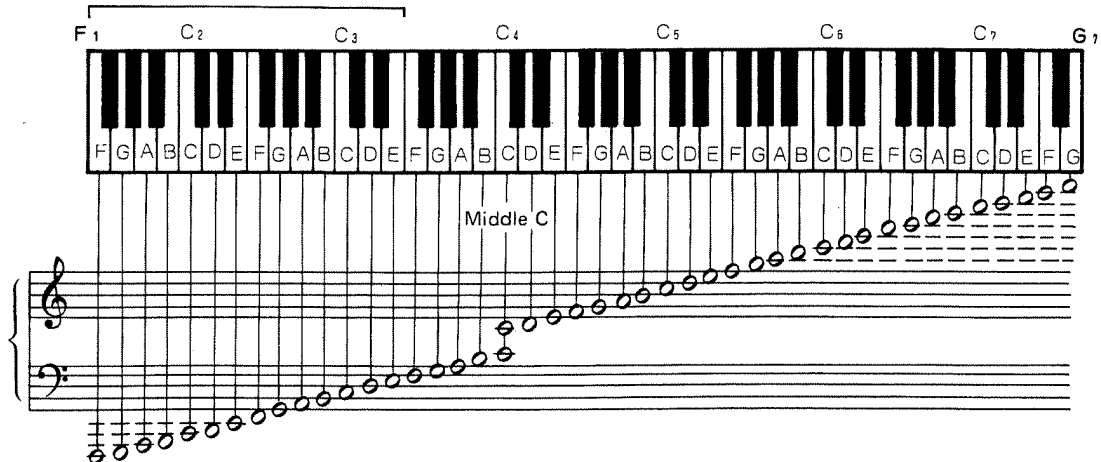

SPECIFICATIONS

MP-700 COMBO PIANO

- KEYBOARD

75 keys (F1 – G7)

- TABLET

PIANO I (mellow piano sound)

PIANO II (bright piano sound)

- HARPSICHORD

- BASS

BASS MUTE } F1 – E3, 2 oct.

- ACCENT

- CONTROL

- TOTAL

BASS (BASS TABLET – ON)

BALANCE (TREBLE – BASS)

ACCENT (ACCENT TABLET – ON)

- DECAY TIME

- OUTPUT (SIGNAL OUT)

- TO AMP

H: Max. output, approx. –10dB

M: Max. output, approx. –20dB

L: Max. output, approx. –30dB

Output impedance, approx. 2.5k Ω

LINE, Max. output, approx. –10dB

Output impedance, approx. 20k Ω

PHONE, Max. output, approx. 200mW

(Stereo headphone impedance, 8 Ω)

- PEDAL (PEDAL IN)

- DAMPER

- GLIDE

- OTHERS

SIGNAL OUTPUT LEVEL SWITCH

TUNING CONTROL (442Hz, \pm 30 cents)

POWER SWITCH (with pilot lamp)

- EXTERNAL DIMENSIONS

1,280(W) X 245(H) X 610(D)mm

- WEIGHT

54kg

- POWER CONSUMPTION

15W

- ACCESSORIES

Stand KS-70

2.5m connection cord

Vinyl cover

KS-70 STAND FOR MP-700

- STAND, chromium-plated

- BACK RAIL, Matt black coating (folding)

- KNOB BOLT, long – 4, short – 2, small – 1

- SET-UP DIMENSIONS

1,450(W) X 760(H) X 550(D)mm

- WEIGHT

10.5kg

MPA-100 AMPLIFIER FOR MP-700 (OPTION)

- OUTPUT

120Wrms

- SPEAKER

25cm X 4 (2 channels)

- FOOT PEDAL

DAMPER-EFFECT-GLIDE

- INPUT

PIANO IN, approx. –10dB

EXT IN, approx. –10dB

- OUTPUT

EXTERNAL AMPLIFIER (Stereo or Mono)

H: Max. output, approx. 0dB

M: Max. output, approx. –12dB

L: Max. output, approx. –24dB

Output impedance, approx. 600 Ω

- PEDAL OUTPUT

DAMPER (step on – makes)

GLIDE (step on – makes)

- EFFECT

CHORUS/VIBRATO SWITCH

VIBRATO SPEED ADJUSTMENT (1.5Hz – 8Hz)

- OTHERS

SIGNAL OUTPUT LEVEL SWITCH

POWER SWITCH (with pilot lamp)

FUSE HOLDER

EXTERNAL AC OUTLET (110/120V type only)

- EXTERNAL DIMENSIONS

1,280(W) X 620(H) X 310(D)mm

- WEIGHT

48kg

- POWER CONSUMPTION

90W

- ACCESSORIES

50cm connection cord

50cm GLIDE/DAMPER cord

Vinyl cover

DP-10 FOOT PEDAL (OPTION)

- DAMPER PEDAL (plug color – RED)

- GLIDE PEDAL (plug color – BLACK)

- EXTERNAL DIMENSIONS

236(W) X 96(H) X 300(D)mm

- WEIGHT

3kg

SC-70 STAND CASE (OPTION)

- EXTERNAL DIMENSIONS

900(W) X 600(H)mm

- WEIGHT

1.5kg

*Specifications are subject to change without prior notice.

 Roland®

10187

UPC 10187



10981