

 Roland

---

**MIDI** LINEAR SYNTHESIZER PROGRAMMER

---

**PG-1000**

---

**Owner's Manual**

### Bescheinigung des Herstellers /Importeurs

Hiermit wird bescheinigt, daß der/die/das

**ROLAND LINEAR SYNTHESIZER PROGRAMMER PG-1000**

(Gerät, Typ, Bezeichnung)

in Übereinstimmung mit den Bestimmungen der

**Amtsbl. Vfg 1046 / 1984**

(Amtsblattverfügung)

funk-entstört ist.

Der Deutschen Bundespost wurde das Inverkehrbringen dieses Gerätes angezeigt und die Berechtigung zur Überprüfung der Serie auf Einhaltung der Bestimmungen eingeräumt.

**Roland Corporation Osaka / Japan**

Name des Herstellers/Importeurs

### RADIO AND TELEVISION INTERFERENCE

**Warning** This equipment has been verified to comply with the limits for a Class B computing device pursuant to Subpart J, of Part 15, of FCC rules. Operation with non-certified or non-verified equipment is likely to result in interference to radio and TV reception.

The equipment described in this manual generates and uses radio frequency energy. If it is not installed and used properly, that is, in strict accordance with our instructions, it may cause interference with radio and television reception.

This equipment has been tested and found to comply with the limits for a Class B computing device in accordance with the specifications in Subpart J, of Part 15, of FCC Rules. These rules are designed to provide reasonable protection against such a interference in a residential installation. However, there is no guarantee that the interference will not occur in a particular installation. If this equipment does cause interference to radio or television reception, which can be determined by turning the equipment on and off, the user is encouraged to try to correct the interference by the following measure:

- Disconnect other devices and their input/output cables one at a time. If the interference stops, it is caused by either the other device or its I/O cable.

These devices usually require Roland designated shielded I/O cables. For Roland devices, you can obtain the proper shielded cable from your dealer. For non-Roland devices, contact the manufacturer or dealer for assistance.

If your equipment does cause interference to radio or television reception, you can try to correct the interference by using one or more of the following measures:

- Turn the TV or radio antenna until the interference stops.
- Move the equipment to one side or the other of the TV or radio.
- Move the equipment farther away from the TV or radio.
- Plug the equipment into an outlet that is on a different circuit than the TV or radio. (That is, make certain the equipment and the radio or television set are on circuits controlled by different circuit breakers or fuses.)
- Consider installing a rooftop television antenna with coaxial cable lead in between the antenna and TV.

If necessary, you should consult your dealer or an experienced radio/television technician for additional suggestions. You may find helpful the following booklet prepared by the Federal Communications Commission:

How to Identify and Resolve Radio-TV Interference Problems

This booklet is available from the U.S. Government Printing Office, Washington, D.C. 20402.

Stock No. 004-000-00345-4

Please read the separate volume "MIDI", before reading this owner's manual.

**Copyright © 1987 by ROLAND CORPORATION**

All rights reserved. No part of this publication may be reproduced in any form without the written permission of ROLAND CORPORATION.

# 1 PANAL DESCRIPTIONS

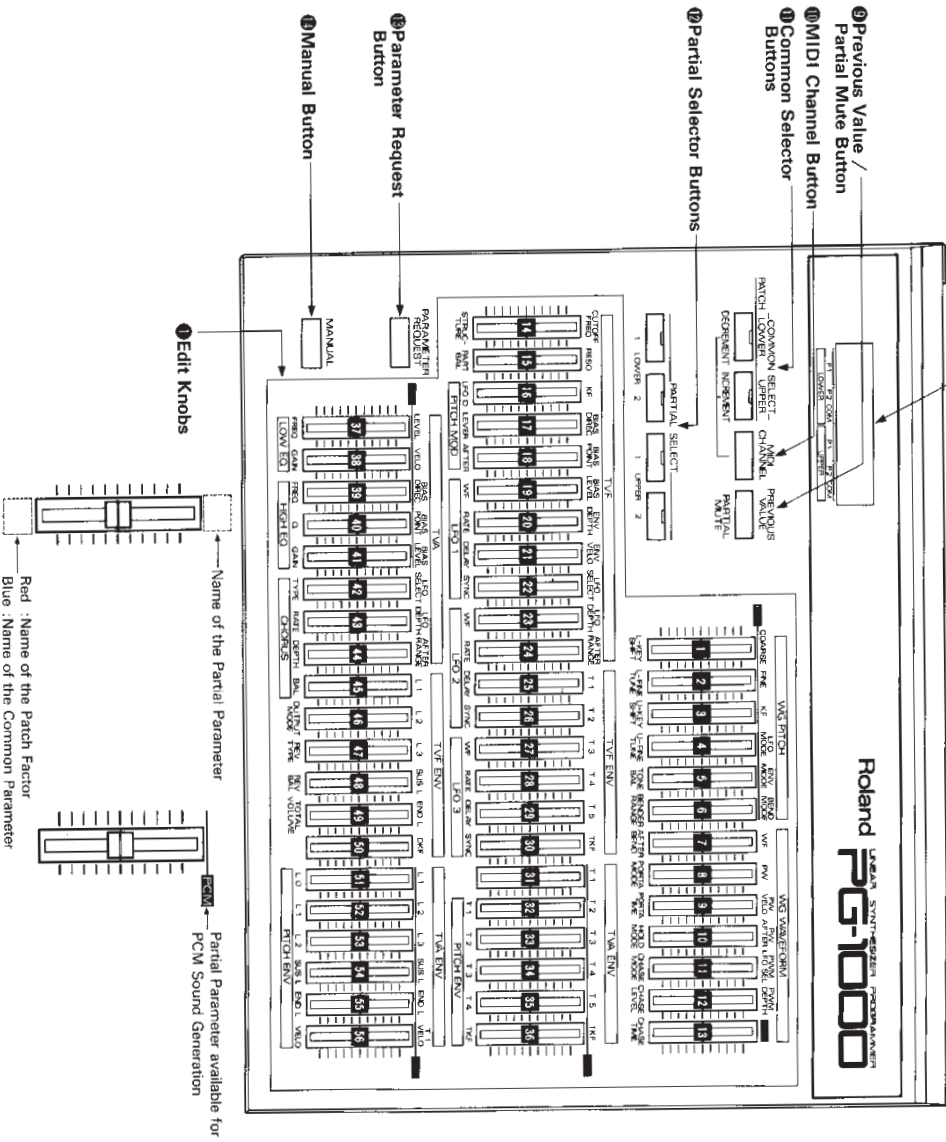
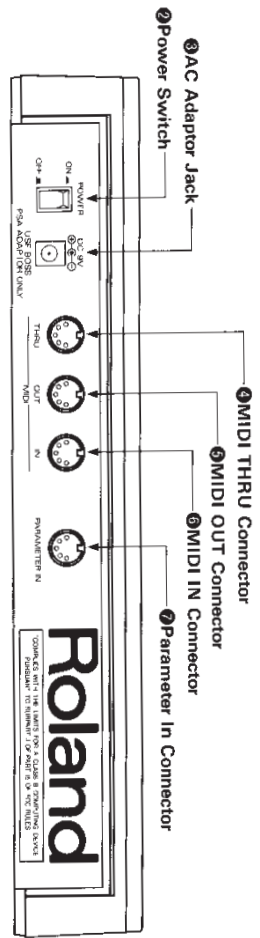

## • Edit Knob Table

Number	Partial Parameter	Number	Common Parameter/Patch Factor
1	WG Pitch Coarse	1	Key Shift(Lower)
2	WG Pitch Fine	2	Fine Tune(Lower)
3	WG Key Follow(Pitch)	3	Key Shift(Upper)
4	WG LFO Mode	4	Fine Tune(Upper)
5	WG P-ENV Mode	5	Tone Balance
6	WG Bender Mode	6	Bender Range
7	WG Waveform	7	After (Pitch Bender)
8	WG Pulse Width	8	Portamento Time
9	WG Pulse Width Velocity Range	9	Hold Mode
10	WG Pulse Width Aftertouch Range	10	Chase Mode
11	WG PWM LFO Select	11	Chase Level
12	WG PWM Depth	12	Chase Level
13	WG PCM Wave Number	13	Chase Time
14	T.V.F. Cutoff Frequency	14	Structure Number
15	T.V.F. Resonance	15	Partial Balance
16	T.V.F. Key Follow(Cutoff Point)	16	Pitch LFO Depth
17	T.V.F. Bias Direction	17	Pitch Lever Modulation
18	T.V.F. Bias Point	18	Pitch Aftertouch Modulation
19	T.V.F. Bias Level	19	LFO 1 Waveform
20	T.V.F. ENV Depth	20	LFO 1 Rate
21	T.V.F. ENV Velocity Range	21	LFO 1 Delay Time
22	T.V.F. LFO Select	22	LFO 1 Sync
23	T.V.F. LFO Depth	23	LFO 2 Waveform
24	T.V.F. Aftertouch Range	24	LFO 2 Rate
25	T.V.F. ENV Time1	25	LFO 2 Delay Time
26	T.V.F. ENV Time2	26	LFO 2 Sync
27	T.V.F. ENV Time3	27	LFO 3 Waveform
28	T.V.F. ENV Time4	28	LFO 3 Rate
29	T.V.F. ENV Time5	29	LFO 3 Delay Time
30	T.V.A. ENV Key Follow(Time)	30	LFO 3 Sync
31	T.V.A. ENV Time1	31	P-ENV Time1
32	T.V.A. ENV Time2	32	P-ENV Time2
33	T.V.A. ENV Time3	33	P-ENV Time3
34	T.V.A. ENV Time4	34	P-ENV Time4
35	T.V.A. ENV Time5	35	P-ENV Key Follow(Time)
36	T.V.A. ENV Key Follow(Time)	36	P-ENV Key Follow(Time)
37	T.V.A. Level	37	Equalizer Lf
38	T.V.A. Velocity Range	38	Equalizer Lg
39	T.V.A. Bias Direction	39	Equalizer Hf
40	T.V.A. Bias Point	40	Equalizer Hq
41	T.V.A. Bias Level	41	Equalizer Hg
42	T.V.A. LFO Select	42	Chorus Type
43	T.V.A. LFO Depth	43	Chorus Rate
44	T.V.A. Aftertouch Range	44	Chorus Depth
45	T.V.F. ENV Level1	45	Chorus Balance
46	T.V.F. ENV Level2	46	Output Mode
47	T.V.F. ENV Level3	47	Reverb Type
48	T.V.F. ENV Sustain Level	48	Reverb Balance
49	T.V.F. ENV End Level	49	Total Volume
50	T.V.A. ENV Key Follow(Depth)	50	P-ENV Level0
51	T.V.A. ENV Level1	51	P-ENV Level1
52	T.V.A. ENV Level2	52	P-ENV Level2
53	T.V.A. ENV Level3	53	P-ENV Sustain Level
54	T.V.A. ENV Sustain Level	54	P-ENV End Level
55	T.V.A. ENV End Level	55	P-ENV Velocity Range
56	T.V.A. ENV Velocity Range(Time1)	56	P-ENV Velocity Range

## INTRODUCTION

The PG-1000 is a programmer specially designed for the D-50. Using the Programmer, a sound on the D-50 can be much more easily and quickly edited or even synthesized from scratch. The MIDI Exclusive messages (specific messages used by individual manufacturer) sent from the PG-1000 does the editing and synthesizing. Therefore, the PG-1000 cannot control the synthesizers of other manufacturers' or even Roland synthesizers which cannot receive the MIDI Exclusive messages.

## CONTENTS

<b>1</b>	<b>Panel Description</b> .....	3
<b>2</b>	<b>Connection</b> .....	6
<b>3</b>	<b>Operation</b> .....	7
	1. Power up .....	7
	2. Preparation .....	7
	3. Basic Operation .....	7
	a. Editing Common Parameters/ Patch Factors .....	7
	b. Editing Partial Parameters .....	8
	c. Partial Mute .....	8
	4. Advanced Operation .....	9
	a. Copying Patch data .....	9
	b. Manual Mode .....	10
	c. Compare .....	11
	d. Monitor .....	11
	e. MIDI Channel setting .....	12
<b>4</b>	<b>Sound Memo</b> .....	13
<b>5</b>	<b>Specifications</b> .....	15

## 2 CONNECTION

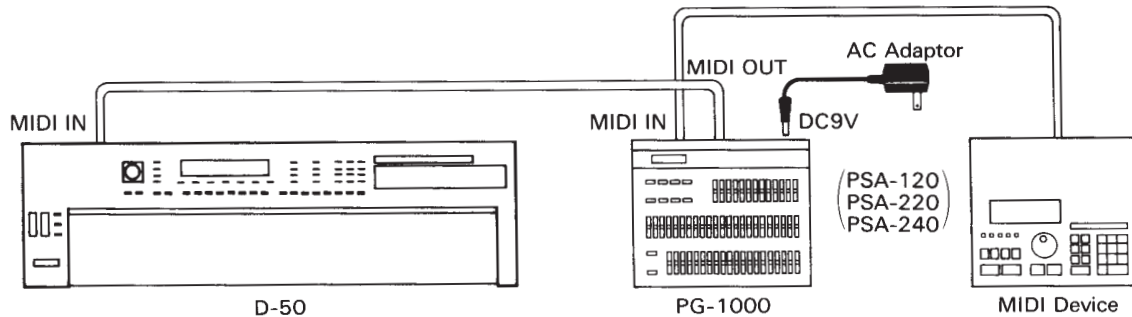

\* The messages fed into the MIDI IN of the PG-1000 is mixed with the sound editing messages created in the PG-1000, and the mixed message is sent through MIDI OUT.

\* The MIDI THRU sends out the exact copy of the messages fed into MIDI IN.

\* When signal from the connected MIDI device stops coming in, the PG-1000's Display will respond as shown below. If this happens, check if the connections are correctly and securely made.

Active Sense Err

### 3 OPERATION

#### 1. POWER UP

► Turn the D-50 on first, then the PG-1000.

The Display responds with:

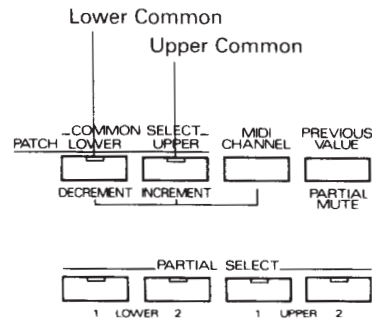
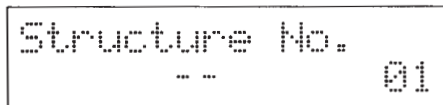
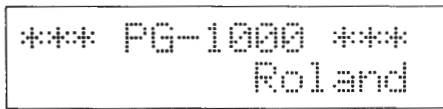

The Common Parameter of the Tone(s) whose indicator is lit can be edited. Each time the button is pushed, the indicator alternately comes on and goes out.

► When the both indicators are lit, the Common Parameters of both Upper and Lower Tones can be edited.

► When neither indicator is lit, Common Parameters cannot be edited.

\* If either of the indicator is lit, Patch Factors can be edited.

The Display shows the name and the value of the Parameter (Patch Factor) which has been edited with the Edit Knob.

#### 2. PREPARATION

Before using the PG-1000, take the following procedure.

① Set the D-50's basic channel to the same number as the MIDI channel of the PG-1000.

The PG-1000 defaults to channel number 1 at power up.

\* The PG-1000's MIDI channel can be changed to other number than 1. See page 12 "MIDI Channel setting".

② Set the Exclusive (MIDI Function) of the D-50 to ON. (Follow the explanation in the D-50's owner's manual.)

#### 3. BASIC OPERATION

The edited data is not automatically written into memory, therefore will be erased when a different Patch is selected on the D-50 or the unit is turned off. If you wish to retain the edited data, take the appropriate writing procedure on the D-50.

##### a. Editing Common Parameters/ Patch Factors

► Select the Tone (Upper, Lower or both Tones) whose Common Parameters to be edited.

##### [Display Example]

###### ● Patch Factor

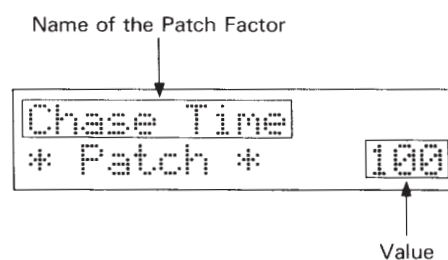

###### ● Common Parameter

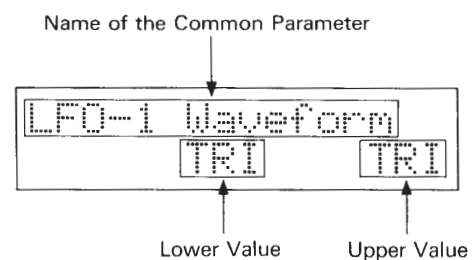

## b. Editing Partial Parameters

- ▶ With the Partial Selector Button, select the Partial whose parameters are to be edited.

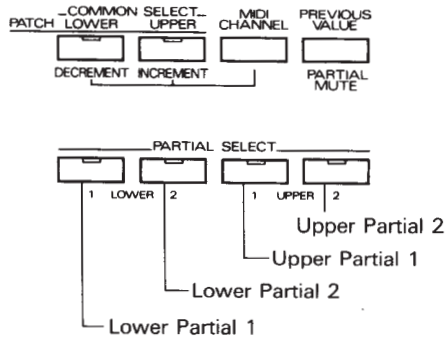

The Parameters of the Partials whose indicators are lit can be edited. Each time the button is pushed, the indicator alternately comes on and goes out.

When more than one indicator is lit, that many Partials can be edited.

The Display shows the name and the value of the Partial Parameter which has been edited with the corresponding Edit Knob.

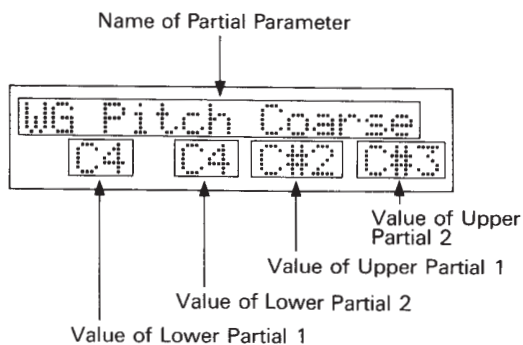

- \* The Parameters of the Partial which has not been selected is shown as "--" in the Display and the value does not change.

## c. Partial Mute

Any of the Partials can be muted.

While holding the Partial Mute Button down (the Partial Selector Buttons flash), select the Partials to be muted by pushing the relevant Partial Selector Buttons.

- \* When the Patch called with Parameter Request is Partial-Muted, the relevant Partial Selector Buttons will remain dark.

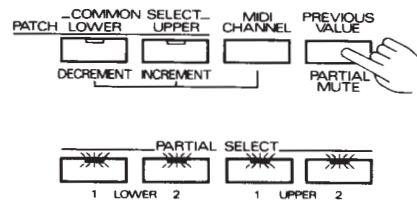

The Partial Selector Buttons of the selected Partials go out and the sounds are muted.

Each time the above procedure is taken, the relevant indicator alternately goes out and flashes.

- \* When the Partial Mute Button is released, all the indicators return to the previous condition. The Partial Mute setting is erased when the unit is turned off.

- \* Partial Mute you have set here will be automatically written into the D-50's memory by taking writing procedure on the D-50.



## 4. ADVANCED OPERATION

The PG-1000 features various useful functions for editing.

### a. Copying Patch data

The PG-1000's copy function allows you to copy any Patch in the D-50 to the programmer. You can copy the Patch to be edited, edit it on the Programmer, compare the edited parameter with the original value (see page 11 "Compare"), or monitor current values of parameters (see page 11 "Monitor".)

Set up the D-50 with the Programmer as shown below.

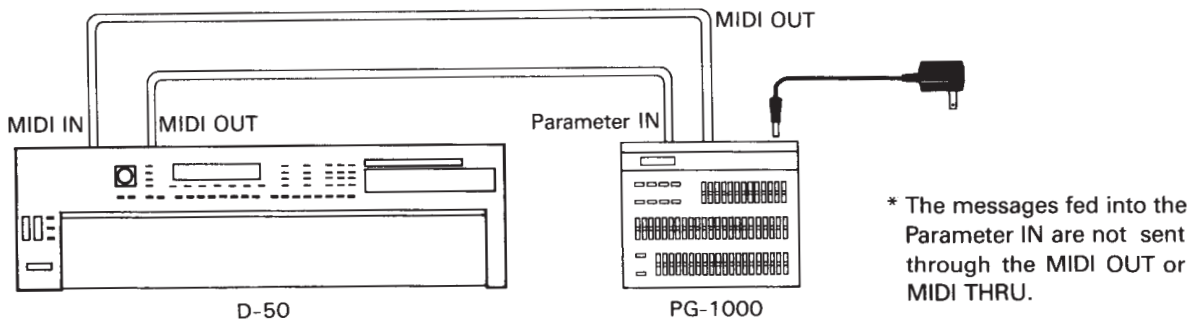

- ▶ Push the Parameter Request Button on the Programmer.



The Display shows the values of the Parameters which are not selected with the Common Selector Button (or with the Partial Selector Button).

- \* If the Display shows an error message as below, check if the connections are correctly and securely made, and push the Parameter Request Button again.

The Patch currently in use on the D-50 is copied to the Programmer and the Display shows as below for a while.

Data Received

Receiving Error



## b. Manual Mode

In Manual mode, the whole panel setting (Edit Knobs) of the Programmer determines the sound. That is, existing sound written in memory has nothing to do with your sound synthesis. You can create a sound from scratch.

- ① **With the Common Selector Button (or the Partial Selector Button), select the Block you wish to turn to the Manual mode.**

You cannot select both the Common Block (Patch) and the Partial Block at a time at this stage. If you want to select both Blocks, repeat steps ① and ②, selecting each Block separately.

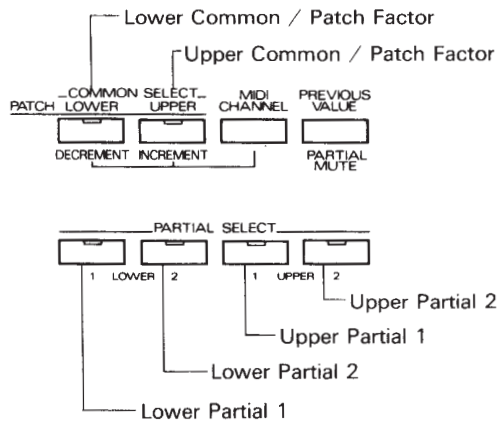

- ② **Push the Manual Button.**



In a few seconds, the Display shows as below for a while.

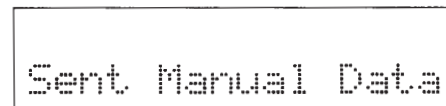

All the parameters of the Block selected in step ① are now controlled by the current positions of the Edit Knobs on the Programmer.

\* The parameter value shown in the Display will remain even when the other Block is selected.

### c. Compare

The Compare function shows the original value of the edited parameter in the Display.

- ▶ **Hold the Previous Value Button down, and the Display shows the original value of the parameter which is edited with the corresponding Edit Knob.**

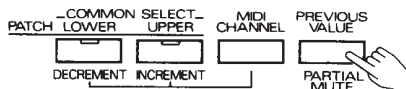

- \* The Compare function is available only when editing a copied data or editing the Block in Manual mode. Otherwise, the Display shows "--".

### d. Monitor

The value of each parameter is not displayed unless the corresponding Edit Knob is moved even slightly. Therefore, the currently set value inevitably changes. The Monitor function allows you to monitor the current value of a parameter without changing the set value. That is, the Edit Knob does not change the value of the parameter but just serves for assigning which parameter is to be monitored.

- \* The Monitor function is available only when editing a copied data or editing the Block in Manual mode. Otherwise, the Display shows "--".

#### Monitoring Common Parameters/Patch Factors

- ① **If it is not editing mode of the Common Parameters (or Patch Factors), push any of the Common Selector Buttons.**
- ② **Turn off the both indicators of the Common Selector Buttons.**
- ③ **Move the Edit Knob that corresponds to the parameter to be monitored, and the value is shown in the Display.**

#### Monitoring Partial Parameters

- ① **If it is not editing mode of the Partial Parameters, push any of the Partial Selector Buttons.**
- ② **Turn off all the indicators of the Partial Selector Buttons.**
- ③ **Move the Edit Knob that corresponds to the parameter to be monitored, and the value is shown in the Display.**

### e. MIDI Channel setting

To set the MIDI channel to other than 1, take the following procedure.

- ① Hold the MIDI Channel Button down. The Display responds with:

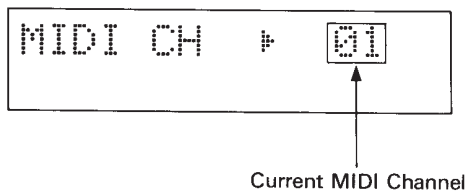

- ② While holding the MIDI Channel Button down, select a channel number with the Common Selector Button.

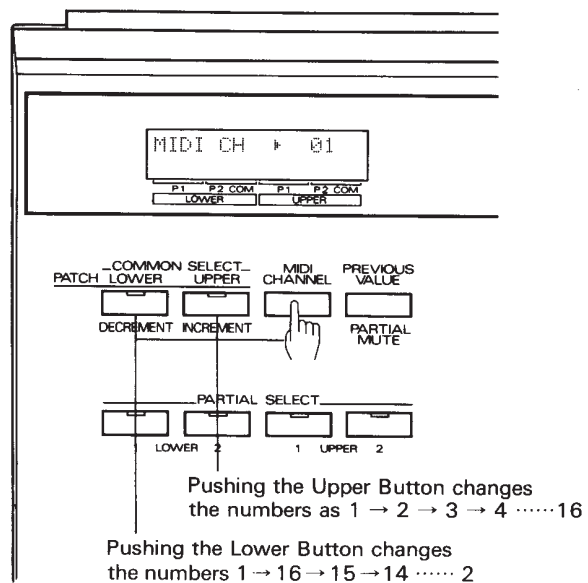

\* The PG-1000 defaults to MIDI channel 1 at power up.

# 4 SOUND MEMO

Patch No. \_\_\_\_\_

Patch Name \_\_\_\_\_

Key Mode	
Sprit Point	
Tone Balance	

L-Key Shift	
U-Key Shift	
L- Fine Tune	
U-Fine Tune	

Bender Range	
After(Pitch Bender)	
Portamento Time	
Portamento Mode	
Hold Mode	

Output Mode	
Reverb Type	
Reverb Balance	
Total Volume	

Chase Mode	
Chase Level	
Chase Time	

MIDI TxCH	
MIDI SepCH	

Used Tone

Upper \_\_\_\_\_

Lower \_\_\_\_\_

Patch No. \_\_\_\_\_

Patch Name \_\_\_\_\_

Key Mode	
Sprit Point	
Tone Balance	

L-Key Shift	
U-Key Shift	
L-Fine Tune	
U-Fine Tune	

Bender Range	
After(Pitch Bender)	
Portamento Time	
Portamento Mode	
Hold Mode	

Output Mode	
Reverb Type	
Reverb Balance	
Total Volume	

Chase Mode	
Chase Level	
Chase Time	

MIDI TxCH	
MIDI SepCH	

Used Tone

Upper \_\_\_\_\_

Lower \_\_\_\_\_

Patch No. \_\_\_\_\_

Patch Name \_\_\_\_\_

Key Mode	
Sprit Point	
Tone Balance	

L-Key Shift	
U-Key Shift	
L-Fine Tune	
U-Fine Tune	

Bender Range	
After (Pitch Bender)	
Portamento Time	
Portamento Mode	
Hold Mode	

Output Mode	
Reverb Type	
Reverb Balance	
Total Volume	

Chase Mode	
Chase Level	
Chase Time	

MIDI TxCH	
MIDI SepCH	

Used Tone

Upper \_\_\_\_\_

Lower \_\_\_\_\_

Tone Name \_\_\_\_\_ Used Patch No. \_\_\_\_\_

**[Common Parameters]**

Structure No.		Pitch ENV		LFO			EQ		Chorus		
		Velocity		Wave	1	2	3	Lf		Type	
		KF(Time)		Rate				Lg		Rate	
Partial Mute				Delay				Hf		Depth	
				Sync.				HQ		Balance	
			L0	Pitch Modulation				Hg			
T1			L1	LFO Depth							
T2			L2	Lever Mod							
T3			SusL	After Mod							
T4			EndL								

**[Partial Parameters 1/2]**

WG		1	2	TVF		1	2	TVA		1	2
WG Pitch	Coarse			TVF	Frequency			TVA	Level		
	Fine				Resonance				Velocity		
	KF(Pitch)				KF(Freq)				Bias Point/ Bias Direction		
WG Modulation	LFO Mode				Bias Point/ Bias Direction				Bias Level		
	P-ENV Mode				Bias Level						
	Bender Mode			TVF ENV	Depth			TVA ENV	Velocity (T1)		
WG Wave Form	Wave Form				Velocity				KF(Time)		
	PCM No.				TVF ENV	KF(Depth)			TVA ENV	T1	
WG Pulse Width	PW			T1				T2			
	Velocity			T2				T3			
	After Touch			T3				T4			
	LFO Select			T4				T5			
LFO Depth			T5			TVA ENV	L1				
TVF ENV	L1			TVF ENV	L2			L2			
	L2				L3				L3		
	L3				SusL				SusL		
	SusL				EndL				EndL		
	EndL				TVF Modulation	LFO Select			TVA Modulation	LFO Select	
TVF Modulation	LFO Depth			LFO Depth				After Touch			
	After Touch			After Touch							

## 5 SPECIFICATIONS

- **Front Panel**

- Edit Knob × 56
- Display
- Previous Value Button/Partial Mute Button
- MIDI Channel Button
- Common Selector Button × 2
- Partial Selector Button × 4
- Parameter Request Button
- Manual Button

- **Rear Panel**

- Power Switch
- AC Adaptor Jack
- MIDI IN Connector
- MIDI OUT Connector
- MIDI THRU Connector
- Parameter In Connector

- **Consumption:** 150mA (DC9V)

- **Weight:** 1.6kg/3lb 9oz

- **Dimensions:** 318(W) × 268(D) × 53(H) mm/  
12-1/2" × 10-9/16" × 2-1/16"

- **Accessories**

- Owner's Manual
- Guide Book "MIDI"
- AC Adaptor PSA-120, 220 or 240
- MIDI/Sync Cable × 1

- **Options**

- MIDI/Sync Cable MSC-07, 15, 25, 50, 100

1. TRANSMITTED DATA

1.1 Undefined Status ( F4H, F5H ) of Common Messages.

Transmits all received MIDI messages except for Reset ( FFH )

1.2 Created message.

Status	Second	Third	Description	
1001 nnnn	0kkk kkkk	0000 0000 kkkkkkk = 0	Note OFF - 127	*1-1
1011 nnnn	0111 1011	0000 0000	All notes off	*1-1
1111 0000	... ..	1111 0111	System exclusive	*1-2
1111 1110			Active Sensing	*1-3

Notes :

- \*1-1 Transmitted when the Parameter Request button is pushed or when MIDI IN's Non Active condition is detected.
- \*1-2 See section 3 ( EXCLUSIVE COMMUNICATION ).
- \*1-3 This unit stops transmitting Active Sense message if this unit detects Non Active condition on MIDI IN.

2. RECOGNIZED RECEIVE DATA

Statu	Second	Third	Description	
1111 0000	... ..	1111 0111	System exclusive	*2-1
1111 1110			Active Sensing	

Notes :

- \*2-1 See section 3 ( EXCLUSIVE COMMUNICATION ).

3. EXCLUSIVE COMMUNICATION

3.1 Request ( One way ) RQ1 11H  
( Transmitted only )

Byte	Description	
a 111 0000	Exclusive status	
b 0100 0001	Roland-ID #	
c 0000 nnnn	Device-ID # = MIDI basic channel. ( 0 - 15 ) where nnnn + 1 = channel #	
d 0001 0100	Model-ID # ( D-50 )	
e 0001 0001	Command-ID # ( RQ1 )	
f 0aaa aaaa	Address MSB	*3-1
g 0bbb bbbb	Address	
h 0ccc cccc	Address LSB	
i 0ddd dddd	Size MSB	*3-1
j 0eee eece	Size	
k 0fff ffff	Size LSB	
l 0ggg gggg	Checksum	
m 1111 0111	End of System Exclusive ( EOX )	

Summed value of the all bytes between Command-ID and EOX must be 00H ( 7 bits ). It doesn't include Command-ID and EOX.

3.2 Data set ( One way ) DT1 12H \*3-2  
( Transmitted and Recognized )

Byte	Description	
a 1111 0000	Exclusive status	
b 0100 0001	Roland-ID #	
c 0000 nnnn	Device-ID # = MIDI basic channel. ( 0 - 15 )	
d 0001 0100	Model-ID # ( D-50 )	
e 0001 0010	Command-ID # ( DT1 )	
f 0aaa aaaa	Address MSB	*3-3,5
g 0bb bbbb	Address	
h 0ccc cccc	Address LSB	
i 0ddd dddd	Data	*3-4,5
:		
j 0eee eece	Checksum	
k 1111 0111	End of System Exclusive	

Notes :

- \*3-1 PG-1000 transmits this command only when the Parameter Request button is pushed. The following values of Address and Size are transmitted.

Address : [ 00-00-00 ]  
Size : [ 00-03-25 ] ( 421bytes )

\* [ hh-mm-ll ] 'hh', 'mm' and 'll' are showed by hex decimal. 0hhhhhhh 0mmmmmmm 0lllllll (binary), MS bit must be 0.

- \*3-2 When operating Parameter Request, the receive connector is not MIDI IN but PARAMETER IN

- \*3-3 If aaaaaa -- ccccccc doesn't indicate the address of the tone parameter or the patch factor, the message will be ignored.

- \*3-4 The received value that exceeds the valid range of the parameter will be ignored.

When the Manual button is pushed, all the parameter values (knob's positions on the panel) of the Partial, Common and Patch will be transmitted.

- \*3-5 See section 4 ( ADDRESS MAPPING OF PARAMETERS AND REMOTE FUNCTION ).

4. ADDRESS MAPPING OF PARAMETERS AND REMOTE FUNCTION

4.1 Parameter base address (Top address)

Address	Description	
[ 00-00-00 ]	Upper Partial 1	( 0 - 53 )
[ 00-00-40 ]	Upper Partial 2	( 64 - 117 )
[ 00-01-00 ]	Upper Common	( 128 - 175 )
[ 00-01-40 ]	Lower Partial 1	( 192 - 245 )
[ 00-02-00 ]	Lower Partial 2	( 256 - 309 )
[ 00-02-40 ]	Lower Common	( 320 - 367 )
[ 00-03-00 ]	Patch	( 384 - 420 )

4.2 Patch write address ( Transmitted only )

Transmitted when the Manual Button is pushed twice while holding the Partial Mute button down.

Address	Description	
[ 00-20-00 ]	Patch write function	*4-1

- \*4-1 Transmitted a Data byte consisting of two 00H ( 2 bytes ).

4.3 Partial parameters

( Parameter address = Base address + Offset )

Offset	Function	Value
0	WG Pitch Coarse	0 - 72 ( C1 - C7 )
1	WG Pitch Fine	0 - 100 ( -50 - +50 )
2	WG Pitch Keyfollow	0 - 16 ( -1, -1/2, -4/1, 0, 1/8, 1/4, 3/8, 1/2, 5/8, 3/4, 7/8, 1, 5/4, 3/2, 2, s1, s2 )
3	WG Mod LFO Mode	0 - 3 ( OFF, (+), (-), A&L )
4	WG Mod P-ENV Mode	0 - 2 ( OFF, (+), (-) )
5	WG Mod Bender Mode	0 - 2 ( OFF, KF, NORMAL )
6	WG Waveform	0 - 1 ( SQU, SAW )
7	WG PCM Wave No.	0 - 99 ( 1 - 100 )
8	WG Pulse Width	0 - 100 ( 0 - 100 )
9	WG PW Velocity Range	0 - 14 ( -7 - +7 )
10	WG PW LFO Select	0 - 5 ( +1, -1, +2, -2, +3, -3 )
11	WG PW LFO Depth	0 - 100 ( 0 - 100 )
12	WG PW Aftertouch Range	0 - 14 ( -7 - +7 )
13	TVF Cutoff Frequency	0 - 100 ( 0 - 100 )
14	TVF Resonance	0 - 30 ( 0 - 30 )
15	TVF Keyfollow	0 - 14 ( -1, -1/2, -4/1, 0, 1/8, 1/4, 3/8, 1/2, 5/8, 3/4, 7/8, 1, 5/4, 3/2, 2 )
16	TVF Bias Point/Direction	0 - 127 ( <A1 - <C7, >A1 - >C7 )
17	TVF Bias Level	0 - 14 ( -7 - +7 )
18	TVF ENV Depth	0 - 100 ( 0 - 100 )
19	TVF ENV Velocity Range	0 - 100 ( 0 - 100 )
20	TVF ENV Depth Keyfollow	0 - 4 ( 0 - 4 )
21	TVF ENV Time Keyfollow	0 - 10 ( 0 - 10 )
22	TVF ENV Time 1	0 - 100 ( 0 - 100 )
23	TVF ENV Time 2	0 - 100 ( 0 - 100 )
24	TVF ENV Time 3	0 - 100 ( 0 - 100 )
25	TVF ENV Time 4	0 - 100 ( 0 - 100 )
26	TVF ENV Time 5	0 - 100 ( 0 - 100 )
27	TVF ENV Level 1	0 - 100 ( 0 - 100 )
28	TVF ENV Level 2	0 - 100 ( 0 - 100 )
29	TVF ENV Level 3	0 - 100 ( 0 - 100 )
30	TVF ENV Sustain Level	0 - 100 ( 0 - 100 )
31	TVF ENV End Level	0 - 1 ( 0, 100 )
32	TVF Mod LFO Select	0 - 5 ( +1, -1, +2, -2, +3, -3 )
33	TVF Mod LFO Depth	0 - 100 ( 0 - 100 )
34	TVF Mod Aftertouch Range	0 - 14 ( -7 - +7 )



35	TVA Level	0 - 100 (0 - 100)
36	TVA Velocity Range	0 - 100 (-50 - +50)
37	TVA Bias Point Direction	0 - 127 (<A1 - <C7, >A1 - >C7)
38	TVA Bias Level	0 - 12 (-12 - 0)
39	TVA ENV Time 1	0 - 100 (0 - 100)
40	TVA ENV Time 2	0 - 100 (0 - 100)
41	TVA ENV Time 3	0 - 100 (0 - 100)
42	TVA ENV Time 4	0 - 100 (0 - 100)
43	TVA ENV Time 5	0 - 100 (0 - 100)
44	TVA ENV Level 1	0 - 100 (0 - 100)
45	TVA ENV Level 2	0 - 100 (0 - 100)
46	TVA ENV Level 3	0 - 100 (0 - 100)
47	TVA ENV Sustain Level	0 - 100 (0 - 100)
48	TVA ENV End Level	0 - 1 (0, 100)
49	TVA ENV T1 Velo Follow	0 - 4 (0 - 4)
50	TVA ENV Time Keyfollow	0 - 4 (0 - 4)
51	TVA Mod LFO Select	0 - 5 (+1, -1, +2, -2, +3, -3)
52	TVA Mod LFO Depth	0 - 100 (0 - 100)
53	TVA Mod Aftertouch Range	0 - 14 (-7 - +7)

#### 4.4 Common parameters

( Parameter address = Base address + Offset )

Offset	Function	Value
10	Structure No.	0 - 6 (1 - 7)
11	P-ENV Velocity Range	0 - 2 (0 - 2)
12	P-ENV Time Keyfollow	0 - 4 (0 - 4)
13	P-ENV Time 1	0 - 50 (0 - 50)
14	P-ENV Time 2	0 - 50 (0 - 50)
15	P-ENV Time 3	0 - 50 (0 - 50)
16	P-ENV Time 4	0 - 50 (0 - 50)
17	P-ENV Level 0	0 - 100 (-50 - +50)
18	P-ENV Level 1	0 - 100 (-50 - +50)
19	P-ENV Level 2	0 - 100 (-50 - +50)
20	P-ENV Sustain Level	0 - 100 (-50 - +50)
21	P-ENV End Level	0 - 100 (-50 - +50)
22	Pitch Mod LFO Depth	0 - 100 (0 - 100)
23	Pitch Mod Lever	0 - 100 (0 - 100)
24	Pitch Mod Aftertouch	0 - 100 (0 - 100)
25	LFO-1 Waveform	0 - 3 (TRI, SAW, SQU, RND)
26	LFO-1 Rate	0 - 100 (0 - 100)
27	LFO-1 Delay Time	0 - 100 (0 - 100)
28	LFO-1 Sync	0 - 2 (OFF, ON, KEY)
29	LFO-2 Waveform	0 - 3 (TRI, SAW, SQU, RND)
30	LFO-2 Rate	0 - 100 (0 - 100)
31	LFO-2 Delay Time	0 - 100 (0 - 100)
32	LFO-2 Sync	0 - 1 (OFF, ON)
33	LFO-3 Waveform	0 - 3 (TRI, SAW, SQU, RND)
34	LFO-3 Rate	0 - 100 (0 - 100)
35	LFO-3 Delay Time	0 - 100 (0 - 100)
36	LFO-3 Sync	0 - 1 (OFF, ON)
37	Low EQ Frequency	0 - 15 (63, 75, 88, 105, 125, 150, 175, 210, 250, 300, 350, 420, 500, 600, 700, 840)
38	Low EQ Gain	0 - 24 (-12 - +12)
39	High EQ Frequency	0 - 21 (250, 300, 350, 420, 500, 600, 700, 840, 1.0, 1.2, 1.4, 1.7, 2.0, 2.4, 2.8, 3.4, 4.0, 4.8, 5.7, 6.7, 8.0, 9.5)
40	High EQ Q	0 - 8 (0.3, 0.5, 0.7, 1.0, 1.4, 2.0, 3.0, 4.2, 6.0)
41	High EQ Gain	0 - 24 (-12 - +12)
42	Chorus Type	0 - 7 (1 - 8)
43	Chorus Rate	0 - 100 (0 - 100)
44	Chorus Depth	0 - 100 (0 - 100)
45	Chorus Balance	0 - 100 (0 - 100)
46	Partial Mute	0 - 3

Value	Partial 1	Partial 2
0	Muting	Muting
1	Sounding	Muting
2	Muting	Sounding
3	Sounding	Sounding

47 Partial Balance 0 - 100 (0 - 100)

#### 4.5 Patch Factors

( Parameter address = Base address + Offset )

Offset	Function	Value
20	Portamento Mode	0 - 2 (U, L, UL)
21	Hold Mode	0 - 2 (U, L, UL)
22	Upper Tone Key Shift	0 - 48 (-24 - +24)
23	Lower Tone Key Shift	0 - 48 (-24 - +24)
24	Upper Tone Fine Tune	0 - 100 (-50 - +50)
25	Lower Tone Fine Tune	0 - 100 (-50 - +50)
26	Bender Range	0 - 12 (0 - 12)
27	After Bend Range	0 - 24 (-12 - +12)
28	Portamento Time	0 - 100 (0 - 100)
29	Output Mode	0 - 3 (1 - 4)
30	Reverb Type	0 - 31 (1 - 32)
31	Reverb Balance	0 - 100 (0 - 100)
32	Total Volume	0 - 100 (0 - 100)
33	Tone Balance	0 - 100 (0 - 100)
34	Chase Mode	0 - 2 (UL, ULU, ULUL)
35	Chase Level	0 - 100 (0 - 100)
36	Chase Time	0 - 100 (0 - 100)

# MIDI Implementation Chart

Function...		Transmitted	Recognized	Remarks
Basic Channel	Default Changed	1 ** 1-16 **	1 ** 1-16 **	
Mode	Default Messages Altered	× * *****	× ×	
Note Number	True Voice	* *****	×	
Velocity	Note ON Note ON	* *	× ×	
After Touch	Key's Ch's	* *	× ×	
Pitch Bender		*	×	
Control Change		*	×	
Prog Change	True #	* *****	× ×	
System Exclusive		○	○	Tone Parameter
System common	Song Pos Song sel True	* * *	× × ×	
System Real Time	Clock Commands	* *	× ×	
Aux Message	Local ON/OFF All Notes OFF Active Sense Reset	* * ○ ×	× × ○ ×	
Notes	<p>*This unit transmits all received MIDI messages except undefined status of Common message. (F4H, F5H and Reset status) **Used as "Device ID" in Exclusive Messages.</p>			

Mode 1 : OMNI ON, POLY  
Mode 3 : OMNI OFF, POLY

Mode 2 : OMNI ON, MONO  
Mode 4 : OMNI OFF, MONO

○ : Yes  
× : No

