

# Roland

## CHORUS ECHO

# RE-301

## INSTRUCTIONS



### FEATURES:

- You can freely combine each of chorus, echo and reverb effects to produce varied effect sound.
- Sound on Sound effect is possible, which enables duet by a single instrument by doubled performance by reproducing input sound 10 – 30 seconds later or by adding another effect sound.
- Twin output system is employed to enhance chorus effect, sound dispersion, and echo effect, which assures rich acoustic effect and stereophonic feeling.
- Wow and flutter is minimized by use of free-running system, which also serves to extend the tape life over 300 hours.



## OPERATION

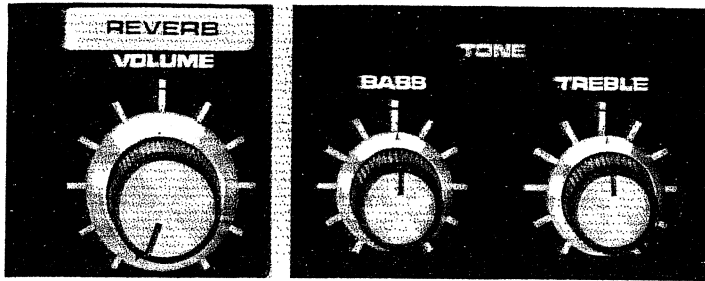

- TO PRODUCE REVERB EFFECT . . .  
First turn all knobs to the setting for normal sound.

- ① Set Reverb Volume to proper level.
- ② Set Input Volume to proper level.
- ③ Set Treble and Bass controls to suit your taste.

Reverb control adjusts the resonance effect to meet the room acoustics. The reverb effect can be added to all of normal sound, chorus and echo effects.

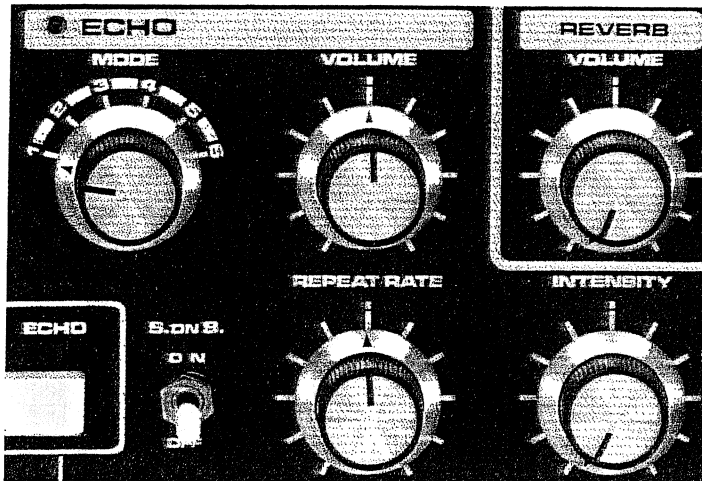

- TO PRODUCE ECHO EFFECT . . .

First turn all knobs to the setting for normal sound.

- ① Depress Echo switch and make sure Echo Effect Indicating Lamp lights up.
- ② Set Input Volume to proper level.
- ③ Set Echo Volume to proper level.
- ④ Set Mode Selector to proper position to obtain the echo rate you hope to get.
- ⑤ Adjust echo repetition with Echo Intensity.
- ⑥ Further, fine-adjust echo rate with Repeat Rate.

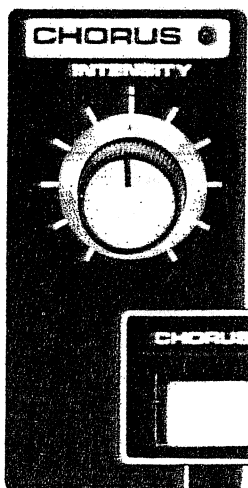

- TO PRODUCE CHORUS EFFECT . . .  
First turn all knobs to the setting for normal sound.

- ① Depress Chorus switch and make sure Chorus Effect Indicating Lamp lights up.
- ② Set Input Volume to proper level.
- ③ Adjust chorus effect sound with Chorus Intensity control.  
Chorus effect changes normal sound to thick, unison sound.



- TO PRODUCE SOUND ON SOUND EFFECT . . .

First turn all knobs to the setting for normal sound.

- ① Set Sound on Sound switch to ON.
- ② Set Input Volume to proper level.  
Sound on Sound effect reproduces input sound 10 – 30 seconds later to achieve doubled performance or to add another effect sound on the sound being performed.

ECHO



SINGLE DELAY

- TO PRODUCE SINGLE DELAY . . .  
When you flip Single Delay switch down, single delay (one-time repeat) is obtained, irrespective of setting of Echo Intensity control.

## CONNECTIONS

- CONNECTING TO PA MIXER OR VOCAL MIXER** Adjustment of echo effect (deepness) is made by Echo Volume on RE-301 and effect volume for each channel on the mixer.

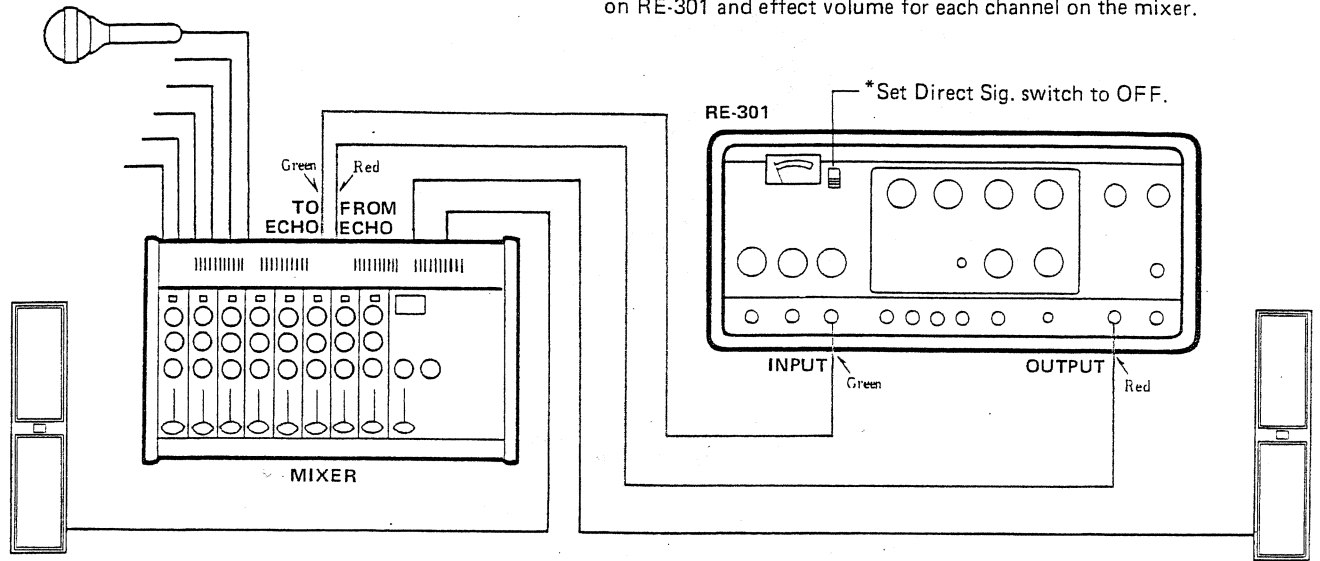

- CONNECTING TO MICROPHONE, INSTRUMENT, ETC.**

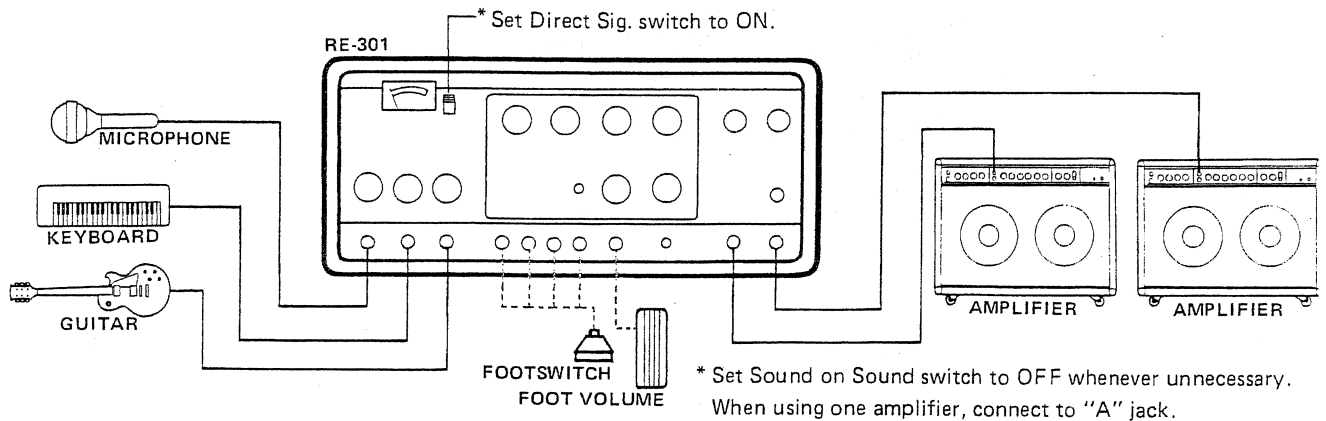

## OPERATION

- After completing connections, normally set Chorus Intensity, Echo Intensity, Echo Volume, Repeat Rate, Reverb Volume, Treble and Bass Controls to middle positions (12 o'clock) and Input Volume to extreme counterclockwise (O).

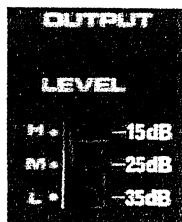

- Set Output Level Changeover switch to proper position to accord with the sensitivity of amplifier you use.

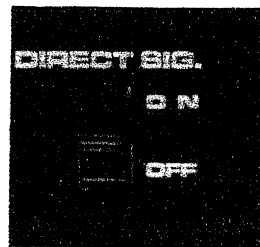

- Set Direct Signal switch to ON.

\* When connecting to PA or vocal mixer, set to OFF.

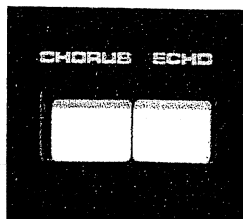

- Set Chorus and Echo switches to OFF (OFF ON).

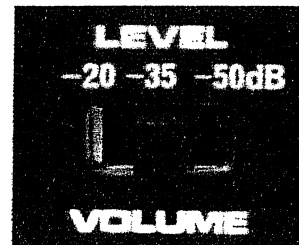

- Set each Input Level switch to proper position to accord with the output level of device you use. Normally, set to -50dB for microphone, -35dB for electric guitar and -20dB for synthesizer.

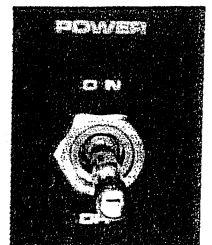

- Make sure that Power Switch is set to OFF. Then connect power and turn Power Switch on, and VU meter lamp will light up.

\* Turn Input Volume to proper level, and normal sound is produced. This setting of knobs is a basic starting point to produce varied effect sounds. When operation is confused, turn back to this setting again.

## EFFECT SECTION

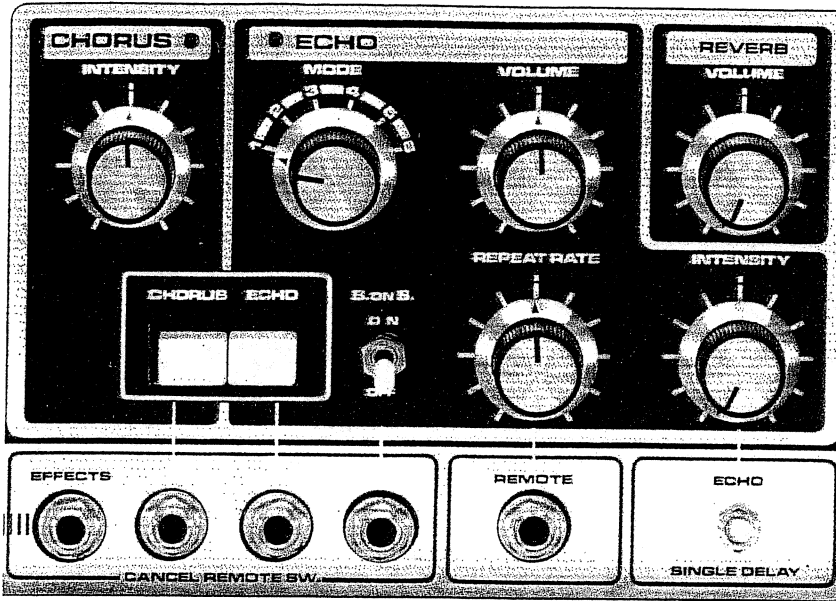

- **CHORUS EFFECT INDICATING LAMP** lights up when Chorus switch is depressed to indicate that chorus effect is active.
- **CHORUS INTENSITY** controls depth of chorus effect. Turn clockwise (⌚) to make deeper and counterclockwise (⌚) to make less deeper.
- **CHORUS SWITCH:** When depressed, chorus effect goes into action and chorus effect indicating lamp lights up. To cancel, push this switch again.
- **EFFECTS JACK:** Connect footswitch FS-1. All effects: echo, chorus, S. on S. and reverb; of Input 3 can be on-off controlled remotely.
- **SOUND ON SOUND:** When set to ON, input sound is reproduced 10 – 30 seconds later. You can double the performance or add another effect sound on your performance simply by handling this switch.
  - \* Be sure to set to OFF whenever unnecessary.
- **REMOTE JACK:** Echo rate can be remote-controlled by foot volume (FV-2), which is very efficient for on-stage performance. Connect to output of foot volume. Treading deeper increases echo repeat rate and vice versa.
- **CANCEL REMOTE SWITCH:** Connect footswitch (FS-1) to respective jack. Chorus, echo effect or S. on S. can be remotely on-off controlled separately.
- **REVERB VOLUME** controls volume of reverberation sound. Turn clockwise (⌚) to get deeper reverberation and counterclockwise (⌚) to make less deeper.
- **ECHO EFFECT INDICATING LAMP** lights up when Echo switch is depressed to indicate that echo effect is active.
- **MODE SELECTOR** controls rate of echo effect. Echo rate decreases in the order of 1 – 2 – 3. At positions, 4 – 5 – 6, soft echo sound with complex effect can be obtained.
- **ECHO SWITCH:** When depressed, echo effect goes into action and echo effect indicating lamp lights up. To cancel, push this switch again.
- **ECHO VOLUME** controls volume of echo sound. Turn clockwise (⌚) to increase and counterclockwise (⌚) to decrease. \*This control does not vary volume of sound other than echo.
- **REPEAT RATE** fine-adjusts the echo rate that is set on Mode Selector. Turn clockwise (⌚) for higher rate and counterclockwise for lower rate.
- **ECHO INTENSITY** adjusts echo repetition. Turn clockwise (⌚) to increase and counterclockwise (⌚) to decrease. At 6 – 7 or over, echo sound will not fade, but oscillation will occur. This can serve to obtain special effect sound.
- **SINGLE DELAY:** Irrespective of Echo Intensity setting, one-repetition, single delay can be obtained. Flip down this switch to get Single delay effect.

## OUTPUT SECTION

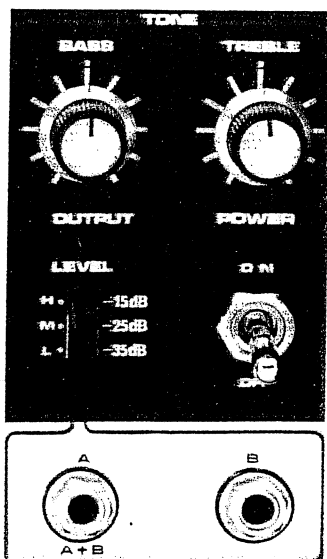

- **BASS** controls volume of low frequency range of echo, chorus and reverb sounds. Turn clockwise (⌚) to boost and counterclockwise (⌚) to cut.
- **TREBLE** controls volume of high frequency range of echo, chorus and reverb sounds. Turn clockwise (⌚) to boost and counterclockwise (⌚) to cut.
- **OUTPUT LEVEL CHANGEOVER SWITCH:** Set to either H, M or L to suit the amplifier you use. When connecting to guitar amplifier or microphone input on PA, set to L or M.
- **TWIN OUTPUT – A-B:** Connect to "A" (RED) jack when using one amplifier. Also, when connecting to PA or vocal mixer, link its FROM ECHO (RED) jack to "A" (RED) jack of RE-301. When using two amplifiers, each sound is separated to either "A" or "B" jack, as shown in table below, making it possible to obtain more effective sound with stereophonic feeling.

EFFECT	OUTPUT	
	A	B
DIRECT	+	
ECHO		+
REVERB	+	
CHORUS	+	+
S. on S.		+

## NAME AND FUNCTION

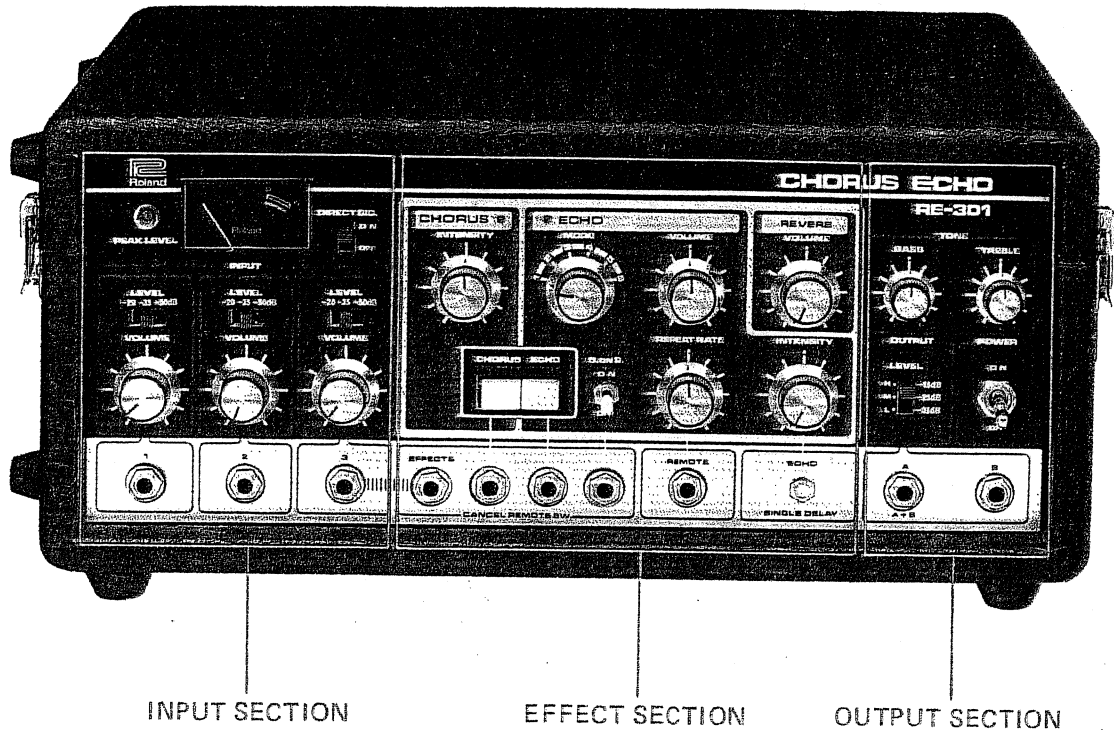

*\*By use of direct-current motor, you are free from worrying about mains frequency.*

### INPUT SECTION

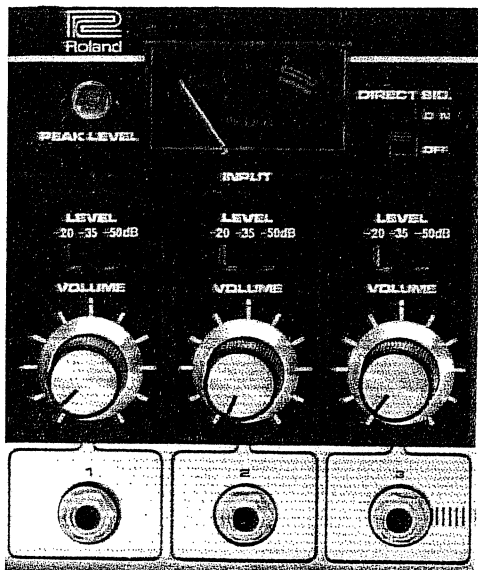

**CAUTION:** -50dB position of Input Level Switch is low impedance exclusively for microphone. -35dB and -20dB are high impedance. Depending on output impedance of instrument you use, the sensitivity may fall when set to -50dB due to impedance mismatching.

- **PEAK LEVEL INDICATOR** detects pulse-like sound that VU meter fails to indicate and lights up with excess input.
- **VU METER** pointer deflects in accordance with input level. Adjust Input Level and Input Volume so the pointer rests -3 - 0, to obtain noise-free, effective sounds.
- **DIRECT SIGNAL SWITCH:** Set to OFF when connecting to PA or vocal mixer.
- **INPUT LEVEL SWITCH:** Select proper level to accord with output level of instrument, microphone, PA or others you connect. (Example: microphone -50dB / guitar -35dB / electronic organ -20dB)
- **VOLUME** allows level control while mixing. Set knobs so the VU meter pointer fluctuates between -3 - 0. (If level is too much even after adjusting this volume is decreased with Input Level at -50dB, change to -35dB. If noise is big even when volume is turned to maximum with Input Level at -20dB, change to -35dB or -50dB.)
- **INPUT JACK (1-2-3)** receives instrument, microphone, etc. By connecting footswitch FS-1 to EFFECTS jack adjacent to INPUT-3 jack, all effects: echo, chorus, S on S and reverb; of INPUT-3 can be on-off controlled remotely.

When connecting to PA or vocal mixer, it is recommendable to link its TO ECHO (GREEN) jack to INPUT-3 (GREEN) of RE-301. At this time, set DIRECT SIG switch at OFF.

■ TO REPLACE TAPE . . . .

- Remove five nuts and loosen one bolt at tape replacement opening to take off acrylic cover.
  - Take out tape and clean all faces that come in contact with tape such as bearing, heads, guides, motor shaft, etc. with cleaner.
  - Put a new tape pack and place the tape as illustrated.
  - Put on the acrylic cover and secure the screws.
  - Turn power switch on to run the tape.
- \* To ensure tight contact between heads and tape, preparatory run is required for five minutes.  
 RT-1L used for RE-301 can be used for more than 300 hours.

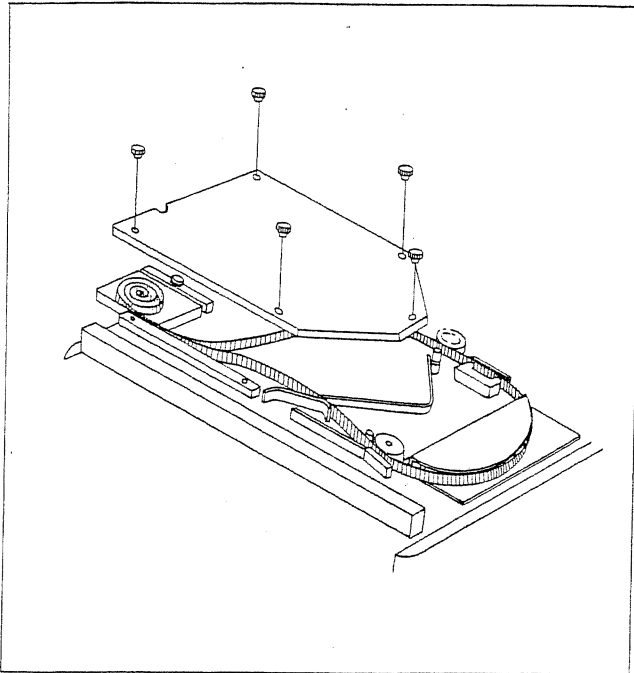

■ TO CLEAN . . . .

If parts indicated by arrows (especially, heads) are soiled, echo sound may deteriorate. Clear off the dirt regularly using attached cleaner set.

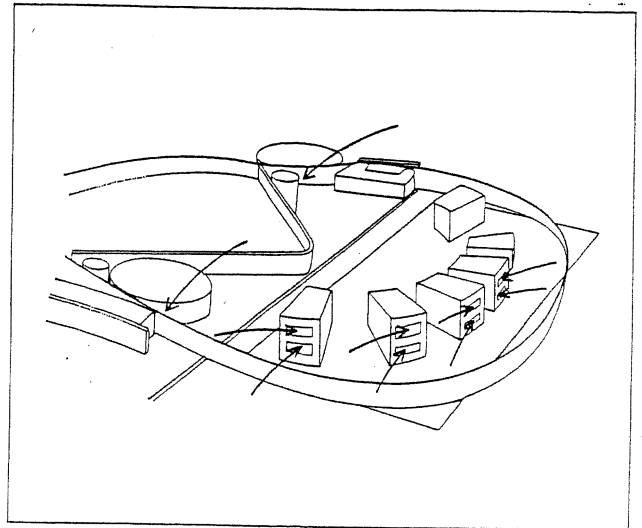

Playback heads are activated by MODE SELECTOR.

		1	2	3	4	5	6
Playback Heads	1	●		●			●
	2		●		●	●	●
	3			●		●	●

MAJOR SPECIFICATIONS

- Power consumption . . . . . 22W  
 Input jack . . . . . 3  
 Output jack . . . . . A + B and A · B  
 Footswitch jack . . . . . Input No. 3 effects On-Off / Chorus On-Off / Echo On-Off / S. on S. On-Off / Remote  
 Control . . . . . Input volume x 3 / Chorus intensity / Echo volume / Repeat rate / Echo intensity / Reverb volume / Treble / Bass  
 Switch . . . . . Input level 3-step changeover switch x 3 / Direct signal / Sound on Sound / Echo On-Off switch / Chorus On-Off switch / Single delay / Output level 3-step changeover switch / Power switch / Rotary 6-mode selector

- Output impedance . . . . . 5kΩ or less  
 Rotary 6-mode selector . . . . . 1  
 VU meter . . . . . 1  
 Erase head . . . . . 1  
 Recording head . . . . . 1  
 Playback head . . . . . 4  
 Dimensions . . . . . 415(width) x 190(height) x 300 (depth)mm  
 Weight . . . . . 10kg  
 Standard accessories . . . . . Connection cord x 2 / Endless tape (RT-1L) / Cleaner set / Vinyl cover

\* Specifications are subject to change without prior notice.

**Roland®**

---

**10212**

UPC

10212



.0981

**Roland®**