



The Roland TR-808 Rhythm Composer is a unique and versatile rhythm device that can be used in a number of ways. Among its many operating features is its ability to write and record thirty two percussive rhythms incorporating up to eleven different sounds plus accents. Each of these percussion sounds has its own level control for full mixing flexibility over the total sound, and each sound also has its own separate output so that it can be mixed or processed separately from the others.

Programming of the Rhythms can be accomplished either in or out of real time by means of a Step programming method which basically breaks each beat down into a series of steps, which can be varied to suit the desired rhythm. Each beat (or quarter note), can be divided into 3, 4, 6, 8, individual steps so that rhythms can be written incorporating as small a division as thirty-second notes.

Once the various rhythm patterns are written and stored in computer memory, they can be arranged to perform an entire composition's percussion track by means of a Compose function. The track can last up to 768 measures. The memory can also be used in individual increments of 64 measures each to play up to twelve different songs.

Three separate Trigger Outputs allow the TR-808 to be connected to various digital sequencers, synthesizers or other such devices for synchronized control of sound. Other performance features such as automatic insertion of Introduction or Fill In rhythms as well as remote control over both this and the Start/Stop function expand the TR-808's uses into live performance in addition to its obvious applications in recording and composing music.

## Table of Contents

---

Introductions .....	1
Front and Back Panel Layout .....	2
Control Descriptions .....	3
Basic Connections .....	6
Playing Rhythm Patterns .....	11
Writing Rhythm Patterns .....	13
Composing the Rhythm Track .....	19
Specifications .....	22

# Front and Back Panel Layout

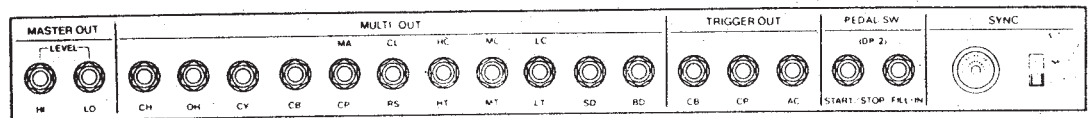
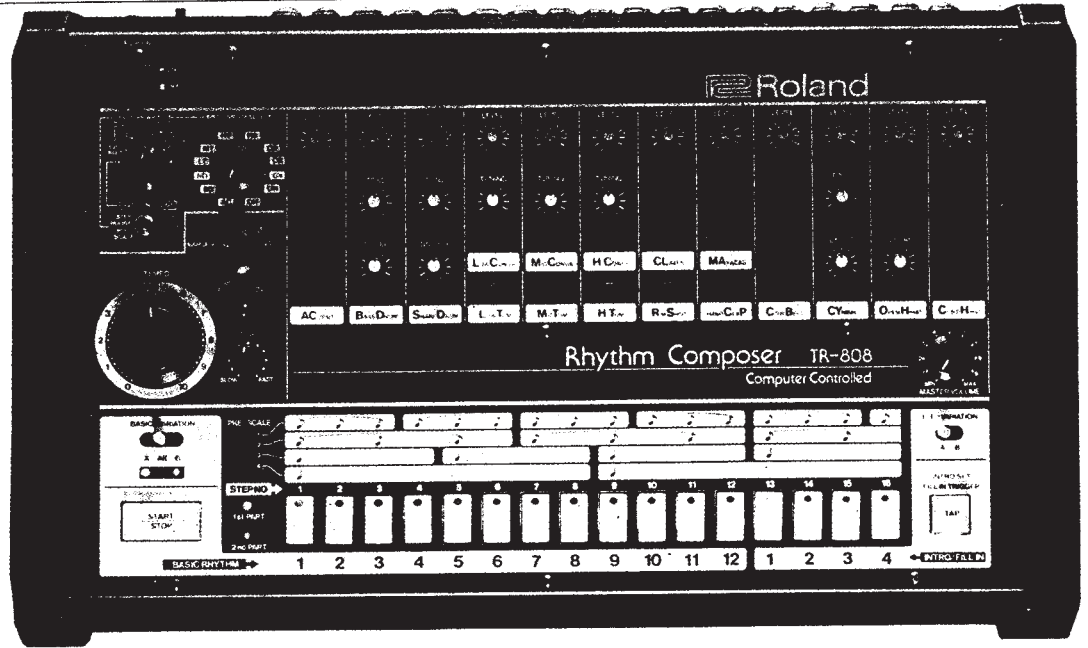

**Power On/Off Switch** This push-On/push-Off switch controls the flow of A.C. power to the TR-808 Rhythm Composer. The power must be switched 'On' for the TR-808 to perform any function. The 'On' status may be verified using any of the various LED lights on the front panel.

**Mode Selector** The MODE selector is the knob located in the extreme upper left hand corner of the TR-808 control panel, used for both programming and playing operations and for memory protection as described

in the Basic Connections section of this manual. Moving clockwise from the lower left the MODE options include: PATTERN CLEAR, 1st PART, 2nd PART, MANUAL PLAY, PLAY, and COMPOSE.

**Rhythm Programming Modes** The first three yellow color-coded positions relate to programming Rhythm Patterns into the TR-808. The boxed PATTERN CLEAR position allows any of the 32 programmed Rhythm Patterns to be wiped from the memory, preparing their memory positions to be reprogrammed. The actual CLEAR function is activated with the red CLEAR button located below the MODE selector.  
1st part position selects the first section of individual measure to be programmed with rhythm information. If the rhythms you are programming are made up from 16 or less evenly spaced increments, the 1st position may be used as a complete single measure by itself.

The 2nd part allows the selection of the second section of an individual measure to be programmed with rhythm information. By combining the 1st part and 2nd parts with suitable PRE-SCALE information it is possible to write rhythms with up to 32 evenly spaced increments for writing complex or subtly flexible rhythms of virtually any time signature. The relationship of the 1st part and 2nd part sections of any measure is determined by the PRE-SCALE programming for that measure, as described in the Writing Rhythm Patterns section of this manual.

**Play Modes** The MANUAL PLAY Mode allows you to play any of the 32 TR-808 Rhythm patterns as you would a conventional rhythm machine, with the addition of automatic switching for intros, and-fills. MANUAL PLAY and PLAY are the only two Mode positions that will protect your programmed memories when the TR-808 is switched off or disconnected.

The PLAY Mode allows a selection of up to 12 independently programmed rhythm compositions to be played with a combined maximum memory of 768 bars. These tracks are selected by the INSTRUMENT/TRACK selector to the right of the MODE selector

**Compose Mode** The Compose Mode position allows the 16 rhythms programmed into the TR-808 to be combined into compositions (Tracks) and programmed into any one or more consecutive memories selected by the INSTRUMENT/TRACK selector positions. To COMPOSE within any of the 12 memories, that memory

must first be cleared using the red CLEAR button. The actual programming of the 16 available rhythms into compositions is done using the STEP buttons along the bottom of the TR-808.

**Instrument/Track Selector** This 12 position selector serves a dual purpose. During the programming of Rhythm Patterns it is used to select which of the 11 different drum voices or the Accent is being programmed. Clockwise from the lower left the choices include AC (ACCENT), BD (BASS DRUM), SD (SNARE DRUM), LT (LOW TOM or LOW CONGA), MT (MID TOM or MID CONGA), HT (HI TOM or HI CONGA), RS (RIM SHOT or CLAVES), CP (HANDCLAP or MARACAS), CB (COWBELL), CY (CYMBAL), OH (OPEN HIHAT), and CH (CLOSED HIHAT). When two options are

available, the instrument to be played is determined by switches within the Instrument section. It makes no difference which of the two instruments is programmed, either may be selected to play back from the same program.

The second function of the control is as a selector for the 12 memories used in composing Rhythm Tracks. Each of the memories contains storage for 64 measures of the track, and can be accessed individually for programming or playback when com-

posing The Rhythm Track, it is only necessary to select the memory position for the beginning of the track. While in the Compose Mode, track switching

is done automatically. Once you have used up the memory available in one position the TR-808 automatically switches to the next track.

## Tempo Control

Used for coarse selection of the TEMPO, this control features forty click-stop positions for increased precision when setting or resetting a Rhythm pattern's tempo. To provide even more precise defini-

tion a FINE control located to the right of the TEMPO control varies the tempo slightly beyond the range of each of the TEMPO control's click stop positions.

## Auto Fill In Selector

The AUTO FILL IN selector is used to insert fill rhythms into the MANUAL PLAY Mode of the TR-808. When the AUTO FILL IN selector is in the MANUAL position, Fill In Rhythms are inserted manually by pressing the TAP button.

Automatic insertion of Rhythms is accomplished in any of the other positions marked 16, 12, 8, 4 and 2. When set at these positions the Fill In Rhythm selected will play every 16th measure, every 12th measure, and so on.

## Voice Selectors

These selectors, located over most of the upper half of the panel are used for the mixing and in some cases, voicing and selecting the various instrument sounds available on the TR-808.

The ACCENT, located at the extreme left of these selectors is used to give emphasis to any other voice programmed on the same step. The LEVEL control sets the amount of emphasis given to the other voices.

The BASS DRUM has variable LEVEL, TONE, and a DECAY control that either allows the drum to ring or to be muffled.

The SNARE DRUM has variable LEVEL, TONE, and a SNAPPY control that simulates the sound of the snares moving closer to and farther from the bottom drum head.

The three TOMs have variable LEVEL, TUNING and can also be switched to become Congas. The RIM SHOT, HAND CLAP, and COW BELL have variable LEVEL and RIM SHOT and HAND CLAP can be switched to become, respectively, CLAVES and MARACAS.

The three Cymbal voices all have variable LEVEL. The CYMBAL voice, which remarkably duplicates a crash cymbal sound, features a TONE control and also a DECAY control to simulate the sound of hitting the Cymbal closer or further from the bell. The OPEN HI HAT sound also features DECAY and this sound is especially effective used in conjunction with the CLOSED HI HAT.

VOICE selectors are variable during both writing Rhythm Patterns and Composing Rhythm Tracks as well as during both PLAY Modes.

## Step Buttons

STEP buttons select which Rhythm is played and are divided into two groups: BASIC RHYTHMS which number 1-12, and INTRO/FILL INs which number 1-4. Normally the BASIC RHYTHMS have priority in they play first when the START/STOP button is pressed. This priority is indicated by their LEDs

flashing. Priority can be assigned to the INTRO/FILL INs by pressing the TAP button.

The STEP buttons are also used in programming Rhythm Patterns as you will see in the section dealing with programming.

## Basic Variation Switch

The BASIC VARIATION switch selects which of the two Modes (A or B) will be played when one of the STEP buttons is pressed. Each of the STEP buttons has two Modes (of one Measure each) which will independently (for a total of 32 different rhythms) or can be played together for a two measure Rhythm. The A Mode plays the A Rhythm while the B Mode

does like-wise. The LED indicators beneath this switch indicate which Mode will play first when in the STOP position and which Mode is playing when the Rhythm is running. When the BASIC VARIATION switch is set to AB the TR-808 will first play the A Mode followed by the B Mode and then repeating in the same manner.

---

**I/F Variation Switch** Performs in exactly the same manner as the BASIC VARIATION switch, but is used only for the INTRO/FILL INs. The playing of A and B I/F VARIATIONS are also indicated by the Variation LEDs.

---

**Start/Stop Button** Begins or ends the playing of a programmed Rhythm or Rhythm Track.

---

**Tap Button** Used for Manual insertion of INTROs and FILL INs and is also used for Manual Programming in Real time.

---

**Master Volume** Sets the overall output volume of the TR-808.

**IMPORTANT:** One basic caution should be observed each time the TR-808 is used to assure the protection of its programs and circuitry. Before the TR-808 is connected or disconnected from its power source, switched 'On' or 'Off', or any connection to other equipment is made or broken:

**Caution**—To afford the ultimate protection to the digital circuitry of your TR-808 make all connections to other equipment with both units' power switched 'Off'. Once all connections are made, switch 'On' the power to the other units first, the TR-808 last. This procedure will give the maximum protection against power surges that might possibly damage the digital circuitry within the TR-808.

It should also be noted that when using the TR-808 by itself (without interfacing to other units using the SYNC connection), the SYNC INPUT/OUTPUT switch on the rear panel should be set to the OUTPUT position. The TR-808 will not operate on its own with this switch in the INPUT position.

## Choosing Amplification

The TR-808 Rhythm Composer may be monitored through any conventional amplification, but ideal amplification will reproduce its realistic drum sounds faithfully with a minimum of added distortion and coloration.

Amplification and speakers with a wide frequency response are necessary to reproduce the TR-808's sounds which range from the high frequencies of the six-oscillator CYMBAL sound to the bass punch of the BASS DRUM. Avoid equipment or speakers chosen to color the sound to suite a particular instrument such as a guitar or bass guitar. These amplification setups influence the sound considerably and in their efforts to aid one specific type of sound severely limit many others.

The TR-808's percussive, accented sounds produce sudden high level output signals which may cause distortion in the pre-amplifier section of amps not built to handle them. Amplification for the TR-808 should be capable of accepting this signal without breaking up or distorting and still produce sufficient final volume levels. The MASTER OUT section on the back panel of the TR-808 includes both HI and LO gain outputs to assist in matching the output level to external amplification. These outputs combine with the individual Instrument LEVEL controls and the MASTER VOLUME control to allow very precise control over the TR-808 output level and balance.

## Level Matching

When using amplification with both Hi and Lo gain inputs begin by matching the Hi gain output of the TR-808 to the Lo gain input of your amp. Listen to this combination, then compare the Lo output to Hi input and choose the combination with the lowest noise level. If distortion is present and more headroom is needed at the pre-amp, send the TR-808 Lo gain output to the Lo gain input of the amplifier. Amplification with variable input attenuation should be stepped far enough to allow sufficient headroom for your most complex, demanding sounds.

To check your amplification, set each Instrument

LEVEL control to approximately the 2 o'clock position, set the MASTER VOLUME control to a central position, and play various rhythms with the TR-808. Listen carefully for any fuzziness, lack of crispness, fragmented attacks or other evidence of distortion. Adjust your connections and level settings, trying to achieve the cleanest possible sound while maintaining a sufficient volume level. On amps with a separate Pre-amp and Master Volume controls it is usually best to set the Pre-amp for a clean signal and adjust the Master Volume of the amp if you need extra level.

## Audio Outputs

The TR-808 offers a complete selection of Audio Outputs to give you creative control over its sounds. The MASTER OUT jacks already mentioned are summed outputs, combining the outputs of each instrument within any given program in proportion to own Instrument Level Control. This summed output is acted upon as a whole by the MASTER VOLUME control before it is sent to the HI and LO MASTER OUT jacks.

The TR-808 back panel also includes a separate

MULTI OUT jack for each individual instrument. Connecting any of these jacks removes that instrument from the summed MASTER OUT signal, sending it off separately at a level determined by its own instrument LEVEL control. The MASTER VOLUME control has no effect on these outputs. These individual instrument Outputs allow effects to be added or fine adjustments to be made to individual drum sounds, or allows complete control over a stereo drum mix.



## Connection Cords

The TR-808 is provided with a low noise connection cord terminating in a 1/4 inch phone jack for output connection on the other end. The 1/4 inch phone jack adapter will be used for most amplification connection.

The RCA jack offers access to most component hi-fi systems, a significant advantage when the TR-808 is used for practice or composition at home without the inconvenience of transporting and setting up stage amplification. Connect the TR-808 LO MASTER OUT to an AUX. or TAPE input, avoiding the PHONO inputs with their special internal equalization. The TR-808 will appear at one speaker only

unless a 'Y' cable or junction box such as the Roland Boss J-5 is used, or unless your hi-fi has a master Mono/Stereo selector. **IMPORTANT NOTE:** Begin with the MASTER VOLUME on your TR-808 set at Zero, and the hi-fi at normal or lower than normal levels. By gradually raising the TR-808 level and using caution as different programs and instrument levels are selected you can easily avoid high level signals that might otherwise damage sensitive hi-fi equipment.

The RCA jack also offers instant access to many multi-track tape recorders and consoles, a distinct advantage considering the unique functional abilities of the TR-808 Rhythm Composer.

## Trigger Outputs

The TR-808 Rhythm Composer provides three independent, programmable Trigger Outputs to allow interfacing with synthesizers or sequencers. Each trigger signal is a positive 15 Volt, 20 millisecond pulse suitable for activating either the Trigger or Gate inputs of most major brands of equipment

A synthesizer such as the Roland SH-09 or SH-2 may be Gated to process its own oscillators or to process one of the TR-808 outputs. By combining a solo synthesizer such as the SH-09 with a sequencer such as one of the Roland CSQ digital series, the TR-808 Triggers will start and/or step the sequencer/synthesizer combination for programmed musical lines that may also be used to control

the rhythm and rate of the Arpeggio sections of the Roland Jupiter polyphonic synthesizers.

The three Trigger Outputs correspond to rhythms programmed into the CB (COWBELL), CP (HAND-CLAP) and/or the AC (ACCENT) respectively, rhythms determined by the INSTRUMENT/TRACK selector and programming. These instruments may be used simultaneously with their Trigger Outputs or programmed specifically to provide Trigger Output rhythms, silencing the instruments using the individual Instrument LEVEL control

Figure 1 illustrates various interfacing applications for the Trigger Outputs.

## Pedal Switching

The TR-808 is equipped with two 1/4 inch Pedal Switch jacks for connection with optional Roland DP-2 Damper pedals. These jacks provide remote control options for the Start/Stop function and the

Fill-In function without defeating those functions at the front panel START/STOP button and TAP button respectively.

## Sync In/Out

The SYNC In/Out section of the TR-808 allows it to be synchronized perfectly with units such as the Roland CSQ-600 Digital Sequencer, allowing each unit total rhythmic freedom while remaining in perfect tempo with one another. This interfacing uses the exclusive TR-808 PRE-SCALE and the CSQ-600 SYNC LOAD functions and controls the tempo, starting and stopping of both units from the CSQ-600.

The TR-808 may also be Sync'd to the Arpeggio section of the Roland Jupiter 8 polyphonic synthesizer.

To Sync two units, connect a five pin DIN cord to

the SYNC jack on each unit and move the TR-808 SYNC switch to the INPUT position for connection to the CSQ-600, or to the OUTPUT position for connection to the Jupiter-8. Remember that the SYNC switch must be in the OUTPUT position for the TR-808 to operate by itself.

The TR-808 may also be Sync'd to the Roland MC-4 polyphonic sequencer, using either the TR-808 or the MC-4 to control the other unit. For more details refer to the MC-4 owners manual.

Refer to Figure 1 for several specific applications of the SYNC connection.

## Memory Back-up

The TR-808 Rhythm Composer features a non-volatile memory which will retain rhythm programs and track compositions when switched off and disconnected. The TR-808 relies on batteries as a back-up circuit to protect these memories.

The TR-808 batteries must be replaced once a year to ensure proper operation.

To replace the three 1.5 Volt dry cell batteries:

1) Connect the TR-808 to power and switch it 'On' to protect its memories while replacing the bat-

teries. Be sure to have the MODE selector in either the MANUAL PLAY or PLAY position.

- 2) Open the battery cover on the bottom of the TR-808 body using a coin or screwdriver.
- 3) Remove old batteries from the battery case. ALWAYS REPLACE THE ENTIRE SET OF BATTERIES.
- 4) Insert new batteries, making sure that their polarities are correct as indicated in the battery case.
- 5) Close the cover, insert and tighten the retaining screw.

Fig. 1

### TR-808 + SH-09

TR-808

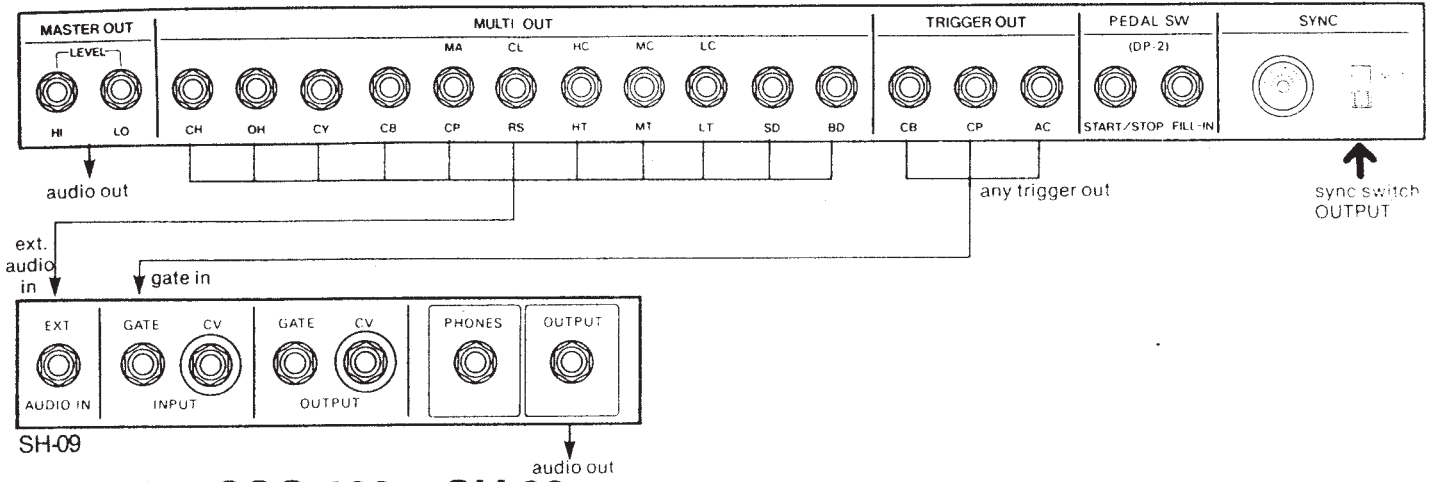

### TR-808 + CSQ-100 + SH-09

TR-808

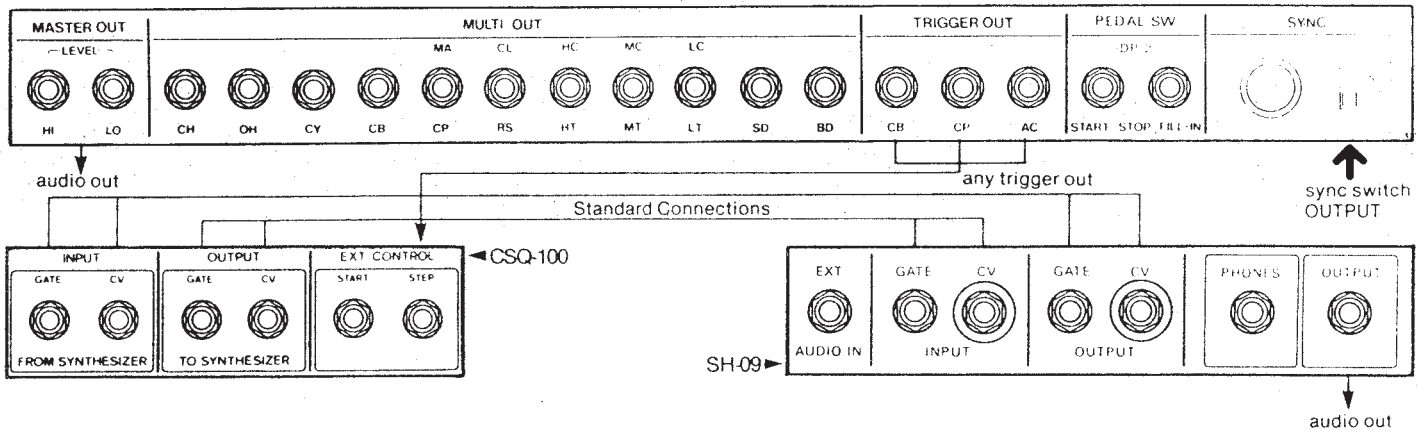

### TR-808 + CSQ-600 + SH-2

TR-808

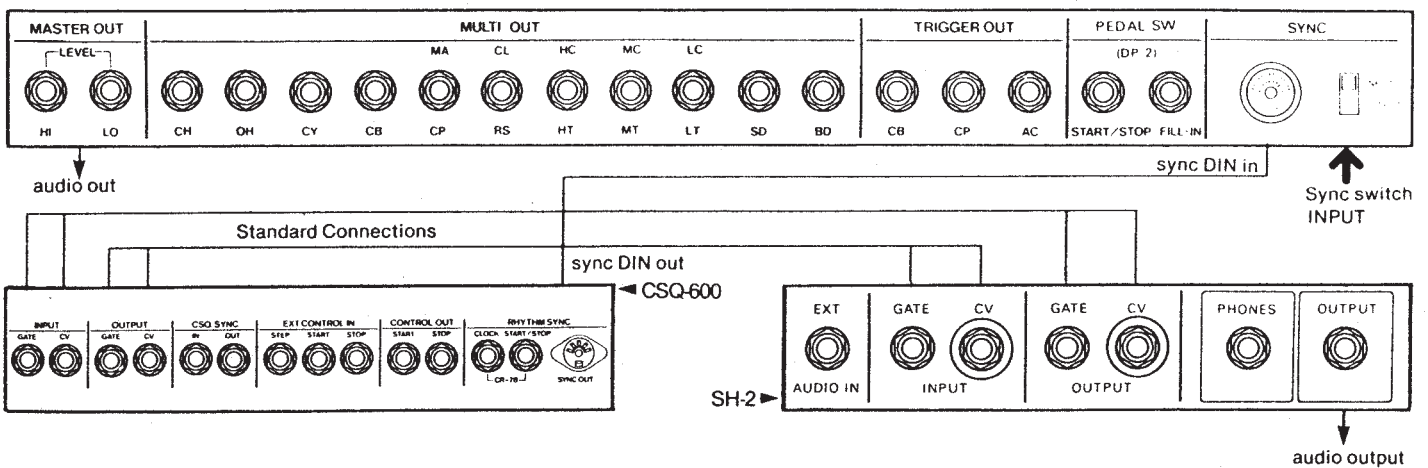

# TR-808 + JP-4

TR-808

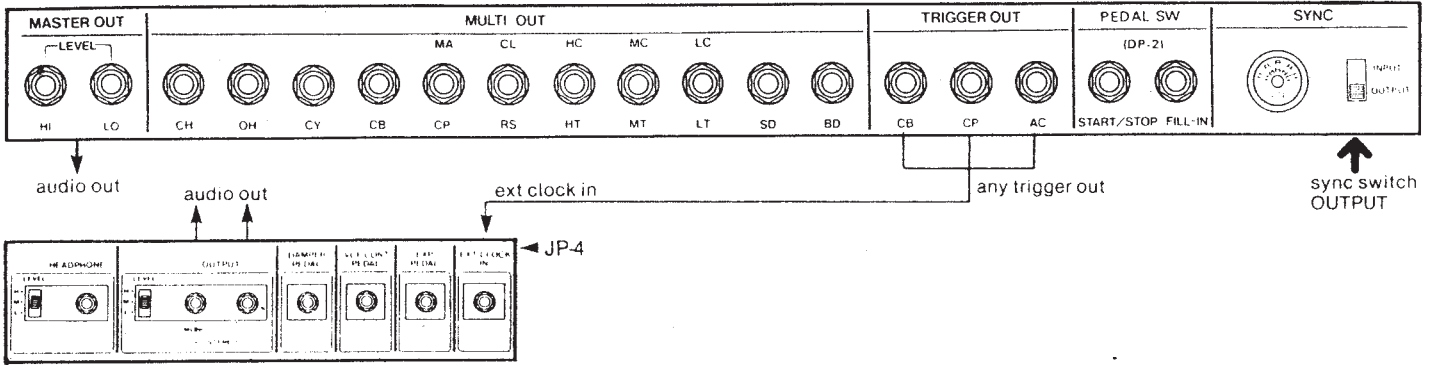

# TR-808 + JP-8

TR-808

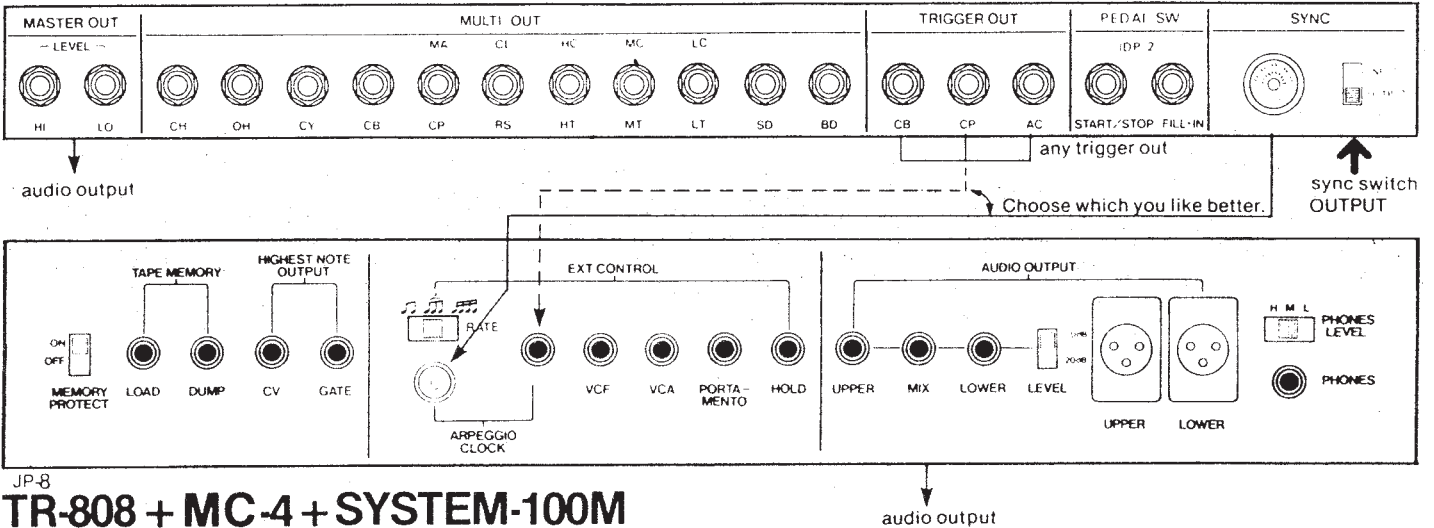

JP-8

# TR-808 + MC-4 + SYSTEM-100M

TR-808

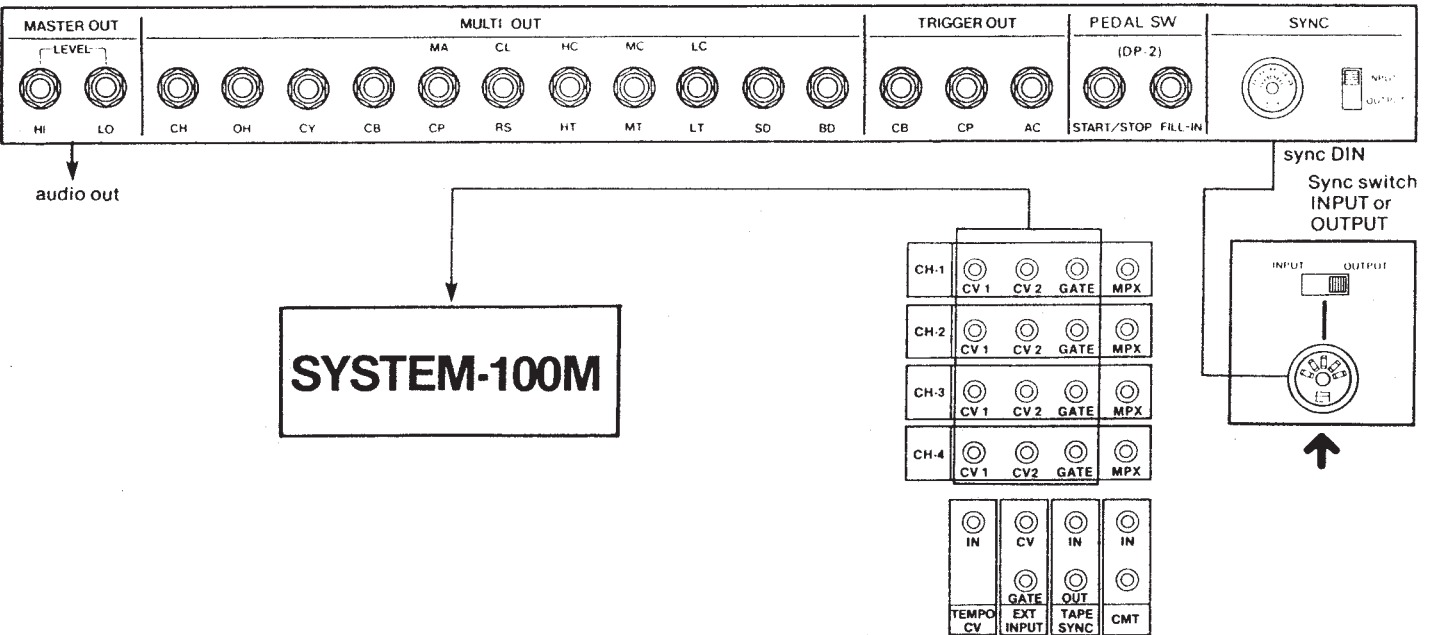

Some commonly used Rhythm patterns have already been programmed into your TR-808, so the first thing you should know is how to play them. The series of sixteen buttons at the bottom of the TR-808 panel are used to select which Rhythm pattern you want to play. Each of these sixteen STEP buttons has two modes (A & B) which can be different from each other for a total of thirty two rhythm patterns, each Rhythm lasting for one measure.

After hooking up the TR-808 as was described in the Basic Connections Section, set the MODE selector (which is the knob located in the upper left hand corner of the unit to the MANUAL PLAY position). When this is done, you will notice that the LED on the Number 6 button will begin to flash. This tells you that the # 6 Rhythm is the first one that will play when you hit the START/STOP button. If # 6 is

not flashing, press that button and it will do so.

Set the BASIC VARIATION switch (immediately over the START/STOP button) to A, and the A LED will light. Press the START/STOP button to start the Rhythm running. Adjust the Tempo with the TEMPO, which is used for coarse adjustment of the Tempo. Subtle Tempo adjustment can be accomplished with the FINE control. While the Rhythm is running you will notice that the LED indicators on the STEP buttons flash in sequence from the left to the right of the unit. The speed of their sequential motion will correspond to the tempo of the pattern (which is set by the TEMPO control).

Press the START/STOP button to stop the Rhythm. When this is done you will notice that the LED on the Rhythm you had selected. (Number 1 in our case) will again begin to flash.

## Mixing Percussion Sounds

Switch on BASIC RHYTHM Number 3, which is a Rock type of Rhythm and press the START/STOP button to start it running. This Rhythm incorporates three different percussion sound — Bass Drum, Snare Drum, and Hi Hat. The level of each of these percussion sounds can be raised or lowered to suit your own taste, and as well the BASS DRUM has a variable Decay which is shortened by turning the Decay control to the left, causing much the same effect as muffling a real bass drum head. The SNARE DRUM has a SNAPPY control which produces the effect of bringing the snares on the drum closer to or father away from the bottom drum head. Both the SNARE and BASS DRUM have TONE controls for setting the instrument's timbre. All three sounds (as well as all sounds on the TR-808) can be mixed by means of the LEVEL controls found at the top of the panel. Experiment with voicing these three sounds and then switch to BASIC RHYTHM # 12.

BASIC RHYTHM # 12 features the sounds of all percussive sounds beating simultaneously. This

Rhythm is used for checking purposes only, and to help you become familiar with the different sounds produced by the TR-808. When using this program, start with the LEVEL of each sound source turned all the way to the left (minimum) position. Raise each Level individually to become familiar with the sound quality and its various adjustments. Five of the Sound Sources have selector switches that allow them to become different instruments or sounds. The three TOM positions can be switched to become CONGAS, the RIM SHOT becomes CLAVES and the HAND CLAP switches to become MARACAS. Becoming familiar with the variety of these percussive voices will allow you to take maximum advantage of the TR-808.

It is possible to switch from one BASIC RHYTHM to another while the Rhythm is playing. The TR-808 will always finish the measure it is playing before switching to the newly selected Rhythm. However, if the new Rhythm is selected on the first beat of the measure the new Rhythm will begin on the second beat of that same measure.

## Adding Intros and Fill Ins

Switch back to BASIC RHYTHM # 3 so that it begins to flash. You will notice that the STEP buttons are divided into two group. The first group is the BASIC RHYTHMS which number from 1-12. The second group of Rhythms 1-4 are located to the right of Number 12 and are used to INTROs and fill ins. You'll see that the # 1 switch in this second group is illuminated, but not flashing.

Press the TAP button (located immediately to the right of the INTRO/FILL IN buttons) and you will see the Number 1 INTRO/FILL IN button begin to flash while the # 3 BASIC RHYTHM button stays lit but does not flash. This means that the # 1 INTRO/FILL IN rhythm will be the Rhythm that will play when you hit the START/STOP button. Unlike the

BASIC RHYTHMS however, the INTRO/FILL IN RHYTHMS will play only once and then switch to the selected BASIC RHYTHM — (in this case # 3). Press the START/STOP button to engage the INTRO/FILL IN. Stop the Rhythm and press the TAP button again. You will see that the # 1 INTRO FILL IN will begin to flash indicating it will play first. Should you want to cancel this function, simply press the TAP button once more, and the # 3 BASIC RHYTHM button will flash, and it will play first when START is engaged.

Fill ins are added in the same way, only while the rhythm is running, rather than at the beginning of the piece. Set your TR-808 so that BASIC RHYTHM # 3 is flashing (indicating its priority). Set the AUTO

FILL IN selector to MANUAL. Select FILL IN rhythm #3 but do not make it flash by pressing the TAP button. Start the BASIC RHYTHM #3, and while it is running press the TAP button. At the end of the measure in which you pressed the TAP button, the TR-808 will switch to INTRO/FILL IN #3 and play it once, and switch back to BASIC RHYTHM #3. In this way you can add FILL IN rhythms wherever you want in a piece of music.

Automatic Fill In Rhythms will occur through use of the AUTO FILL IN selector. When this selector is switched to 2 the FILL IN Rhythm will occur every

2nd measure. When the other positions are selected the FILL IN will occur every 4th, 8th, 12th and 16th measure, automatically. Start the Rhythm running and experiment with the Automatic Fill In function. Should you start the TR-808 running with an INTRO before a BASIC RHYTHM, you will find that the INTRO is not counted in the number of measures in the FILL IN function.

Even during play while using the Automatic Fill In function, FILL IN Rhythms can be further added by pressing the TAP button. To cancel the Automatic Fill In, turn the AUTO FILL IN selector to Manual.

## Variation Function

The TR-808 can play two different Rhythm patterns for each of the sixteen STEP buttons. These are called the A and B Modes and are operated by the two switches labeled BASIC VARIATION and I/F VARIATION. So far we have been operating only in the A Mode of the TR-808. The Variation function is a function that is used to play two measures alternately or to select one or the other from memory. Its position will not be memorized when composing Rhythm Tracks.

Move the BASIC VARIATION switch from the A Mode to the B Mode. You will notice that the LED beneath the switch indicates your motion. The LED indicates which of the Modes you will hear first. Leaving the BASIC RHYTHM button set at #3, play the B Mode of this Rhythm by pressing the START/STOP button. You will notice that it is slightly different from the A Mode. Switch back to A and compare. When the BASIC VARIATION switch is set to either A or B, it will only play that Mode and will not switch from one to the other.

In contrast, when the switch is set at the AB posi-

tion the TR-808 will play the A Mode and the B alternately, always beginning in the A Mode. This position is commonly used to program Rhythms that extend over two measures before repeating, a very common occurrence in Rock music.

If the BASIC RHYTHM you have selected is preceded by an INTRO while in the AB position, the sequence will be: INTRO, A Mode, B Mode. No matter where in a moving Rhythm pattern you switch the Variation position, the new variation will occur on the first beat of the following measure. When Variation A is switched to AB, the change will be: A, B, A, B, in a continuous fashion. Likewise, when Variation B is switched to AB it will also move in a continuous fashion from B to A, B, A, etc.

The I/F VARIATION switch performs in an identical manner to the BASIC VARIATION switch except that it has no AB position as Intro or Fill Ins are usually added only one measure at a time. Like the BASIC VARIATION switch, the A or B Mode is indicated by the LEDs above the START/STOP button.

As we mentioned earlier, your TR-808 will not only play back Rhythms but also allow you to write them as well. Because we are not just writing the

Rhythms but are storing them in Computer Memory as well, we call this process Programming. We will now program the Rhythm Score written in Fig. 2.

Fig. 2

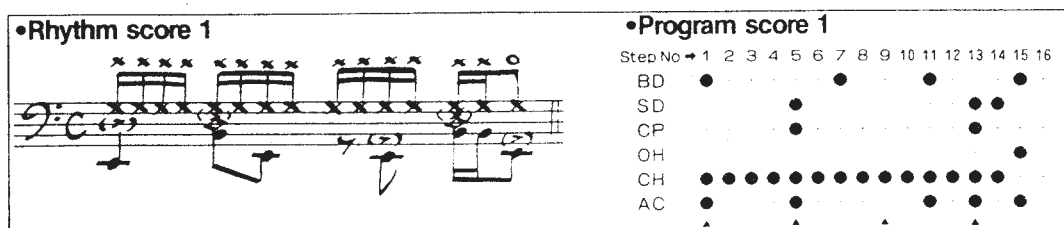

STOP the Rhythm if it is running and set the MODE selector to PATTERN CLEAR. This will cause the LED on the BASIC RHYTHM selected to stop flashing. Press BASIC RHYTHM # 1 and set the BASIC VARIATION to A. Press the CLEAR button (which is located beneath the MODE selector to clear whatever might be in memory. When the CLEAR button is pressed there are instances when the LEDs for the 1st Part, 2nd Part, or the VARIATION may light up or flash on and off. This is normal operation.

The TR-808 programs Rhythms in a Step Sequence process which breaks each measure (and each beat)

down into a series of steps so that programming can be completely accurate. To program a Rhythm, you must first select a PRE SCALE position which basically determines how many steps there will be for each beat (quarter note). This process as well as the 1st and 2nd Part process will be described in detail later in this section. Set the MODE selector to PATTERN WRITE: 1st PART. Press the START/STOP button to Start the Rhythm. This will cause the LEDs to flash in sequence, but you will not hear a Rhythm because it has been cleared. While the Rhythm is running, set the PRE SCALE selector switch to "3" and press the CLEAR button.

## Step Programming

Choose an instrument sound to be programmed by rotating the INSTRUMENT/TRACK selector (located next to the MODE selector). It is usually easiest to program a Rhythm starting with the BASS DRUM so rate the selector to BD. On Program Score 1 you will see BD is to be played on Steps 1, 7, 11, and 15 so touch the BASIC RHYTHM buttons that correspond with these Step Numbers described above them. As is the case with many of the controls on the TR-808, the BASIC RHYTHM buttons serve a dual function that is both choosing Rhythms to be played and also programming the Rhythm itself.

You should now hear the BASS DRUM sound on

those Steps that you selected. If this is not the case, go back to the beginning of this section and repeat the process. When the BASS DRUM is sounding properly, switch the INSTRUMENT/TRACK selector to SD, and program the SNARE DRUM as it indicated on the Program Score 1 at Steps 5, 13 and 14. Continue programming the other instrument voices indicated on the Program Score. It may be easier for you to program if you adjust the TEMPO to a slower speed. If you make a mistake and press the wrong switch, simply press it again and the LED will go out indicating it has been cancelled.

## Tap Programming

While most programming is done using the Step method, it is also possible to program in real time by a TAP method. While the Rhythm you just programmed is running, return the INSTRUMENT/TRACK selector to SD and cancel the Snare Drum sounds you programmed by pressing switches 5, 13,

and 14. You can now re-program the SNARE DRUM simply by pressing the TAP button at appropriate places in the measure. Wherever you pressed the TAP button there will automatically be programmed a Snare Drum sound.

If the Tapped Rhythm is out of sync with the others, it can be erased just the same as when it was programmed in the Step method. Sometimes it may be easier to use the Tap method when the Rhythm is running fairly slowly so that synchronization is easier.

You have just programmed your first Rhythm into the TR-808. This Rhythm will be stored in memory when you stop the Rhythm and move the MODE selector to the MANUAL PLAY position, and can be edited by switching back to 1st Part setting. Press the START/STOP button when programming has been completed.

## Steps and Programming

With the TR-808, each measure is divided into a certain number of parts which we call Steps. The Rhythm you just programmed used a 16 Step measure, which we played in 4/4 time. Therefore the measure was comprised of four quarter notes, each quarter notes was comprised of four sixteenth

notes and each sixteenth note corresponded to one Step. So for each Step in Program Score 1 each Instrument Voice had either a beat or a rest. (The rest is added automatically when you do not program a beat in that place.)

Fig. 3



The program Score is a transcription of the music score using a system that indicates the minimum number of notes and rests. However, it is not completely musically accurate in that a quarter note, for

example, when transcribed to the Program Score from a music score, is written as a sixteenth note, followed by three rests. This also follows for whole notes, half notes and eighth notes as well.

Fig. 4

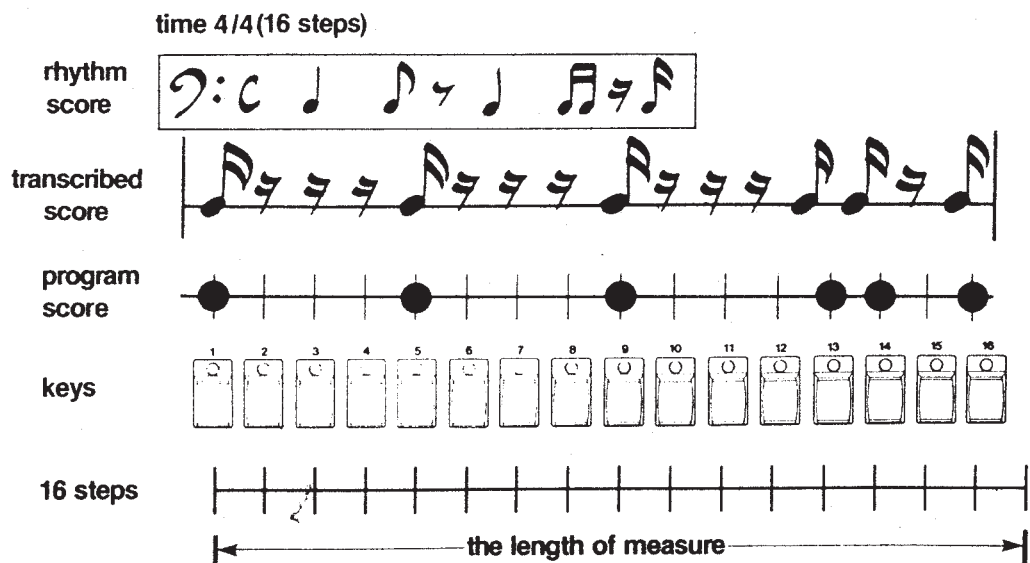



The STEP buttons are arranged in the order of sequence for the Rhythm pattern. This means that in Rhythm Score #1, the #1 switch will indicate the beginning of the measure and #16 equals the end

of the measure. When the LED for step 16 lights up, one measure has been played.

## Setting the Pre-Scale

The Scales on the panel above the STEP buttons indicate the PRE SCALE (or number of steps for each beat). Different PRE SCALES are chosen for different Rhythms so that all the Rhythms will be in time with each other when you switch from one Rhythm to another as you did in the first section. Some Rhythms you may write may require as small a division as thirty second notes while other Rhythms you write need only sixteenth notes as the

smallest division. By choosing the proper Pre Scale for the Rhythm, the Rhythms will be able to be played back in time with each other.

The Pre Scale must always be chosen to match the minimum division of the note to be used in the Rhythm pattern. We will now program a Rhythm in 3/4 time; one that uses a 12 Step measure and the Number 3 Pre Scale.

Fig. 5

•Rhythm score 2

•Program score 2

Step No	1	2	3	4	5	6	7	8	9	10	11	12
BD	●							●	●			
SD						●						
CH	●		●		●		●		●		●	
AC	●				●				●			

STOP the Rhythm and set the MODE selector to PATTERN CLEAR. Press BASIC RHYTHM button #1 so we can program in this position. The LED on that switch should light up but not flash. Make sure the BASIC VARIATION switch is set to A, and press the CLEAR button, erasing the memory. Set the MODE selector to PATTERN WRITE 1st PART and press the START/STOP button. Set the PRE SCALE selector switch to #3. Press the CLEAR button but do not let it up. While holding it down press the switch

for Step #12, then release the CLEAR button. You have just set a 12 Step pattern using a #3 Pre Scale.

With the INSTRUMENT/TRACK selector, choose the sounds you need to program Program Score #2 shown in Fig. 5. Program this Rhythm as you had done in Program Score #1. Programming is done in both BASIC RHYTHM and INTRO/FILL IN positions in exactly the same manner.

# Programming the A and B Variation

Programming of A and B Modes is done in the same manner, the sole difference being the position of the BASIC VARIATION or I/F VARIATION switch during the programming. We will now program a two measure Rhythm Pattern in BASIC Rhythm # 1 position.

STOP the Rhythm and set the MODE selector to PATTERN CLEAR. Make sure you are in BASIC RHYTHM # 1 and set the BASIC VARIATION switch to AB. Press the CLEAR button. Set the MODE

selector to 1st PART PATTERN WRITE, START the Rhythm and set the PRE SCALE selector to 1. While pressing the CLEAR button press the switch for step # 12 as you did before. Set the BASIC VARIATION switch to A and program the following Rhythm, programming the A part only. When this is completed, set the BASIC VARIATION switch to B and program in exactly the same manner. Press the START/STOP button when programming is completed.

Fig. 6

**•Rhythm score 3**

**•Program score 3**

		A												B												
Step No		1	2	3	4	5	6	7	8	9	10	11	12	1	2	3	4	5	6	7	8	9	10	11	12	
BD		●						●						●							●					●
SD					●						●								●			●				
OH		●						●						●								●				
CH					●		●				●		●			●		●	●			●				●
AC											●		●									●				
		▲			▲			▲			▲		▲	▲			▲		▲			▲			▲	

When played back in the AB VARIATION mode the alternate A and B measures will be heard. When the AB position is set during the clearing operation, both A and B memories will be erased at the same time. It is also possible to program while in the AB Mode but remember that the Rhythm will always run from one to the other. This can sometimes be desirable, especially when using the Tap programming method.

Setting a PRE SCALE and Step number in one mode will always make it the same in the other, i.e. a 12 step Pre Scale set in the A Mode will also be the step and Pre Scale for the B Mode and vice versa.

## Programming the 1st and 2nd Part

The programming we have done so far has used only the first part of each A and B memory Modes. The second part is commonly used to allow for Rhythms that require more than sixteen steps for programming. This may be in the form of thirty second notes as would be used in number 4 Pre Scale to complete a 4/4 measure, or can be to accommodate odd rhythms (5/4, 7/8, etc.) that require more than sixteen steps for programming in sixteenth notes. Each of the 1st and 2nd Parts contains 16 steps.

We will now program the following rhythm pattern that uses both the first and second parts. Stop the Rhythm and set the MODE selector to PATTERN CLEAR. Press Basic Rhythm # 1 set the BASIC VARIATION switch to A and press the CLEAR button. Set the MODE selector to 1st PART PATTERN

WRITE, and start the Rhythm. Set the PRE SCALE selector to 4 and press the CLEAR button. Set the MODE selector to 2nd PART PATTERN WRITE. When this last step is done, the LEDs for each step from 1 to 16 will go off. While pressing the CLEAR button, press the switch for Step Number 16 (which indicates Step 32 because you are in the 2nd Part).

When this is done you have set up a 32 Step pattern and the flow of the LEDs will change from the First Part to the Second Part. If the MODE selector is set at 2nd PART then only the flow of the Steps in the Second Part will be indicated by the LEDs. If the MODE selector is set for the 1st PART then only the flow of the steps for the 1st Part will be indicated by the LEDs. Set the MODE selector to 1st PART and Program according to the following Program Score:

Fig. 7

•Rhythm score 4

•Program score 4

Step No	1st																2nd															
	1	2	3	4	5	6	7	8	9	10	11	12	13	14	15	16	1	2	3	4	5	6	7	8	9	10	11	12	13	14	15	16
BD	•						•																									
SD											•																					
LT																																
OH	•																															
CH	•	•	•	•	•	•	•	•	•	•	•	•	•	•	•	•	•	•														
AC	•																•															

When this is done, set the MODE selector to the 2nd PART position and program in the same manner according to the 2nd Part on the Program

Score. Press the START/STOP button when programming has been completed.

As was mentioned before, the 2nd Part is used to program a measure requiring more than 16 Steps. With the Clearing operation (pressing the CLEAR button) both the 1st and 2nd Parts are erased. At this point the 1st Part is set at 16 Steps and the 2nd

Part is set at 0 Steps. Therefore, when using the 2nd Part it is necessary to set up the Step number for the 2nd Part. The number of Steps in the 1st and 2nd Parts do not have to be the same (unlike the A and B Modes which are always the same).

Fig. 8

For 20 steps the number in ( ) refers to the number of steps

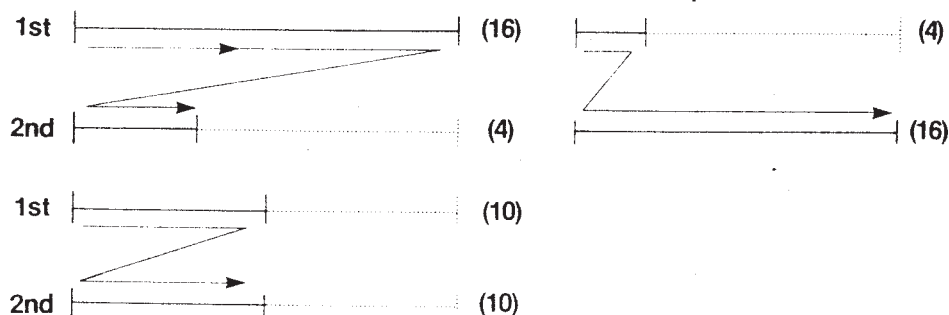

It is also possible to use the 2nd Part to program two different measures (like you did in the A and B Modes), but care should be taken to insure that their tempo is relative to others you have programmed into memory. This is best solved by program-

ming other Basic Rhythms in the same way. Unlike the AB function, programming different measures in the 1st and 2nd Parts always yields an alternate 1st Part, 2nd Part Playback, as the 1st and 2nd Parts cannot be played separately.

## Memory

It is possible to program a total of 32 different Rhythm patterns into the TR-808 (16 x 2) and as we said each of these memories has a 1st and 2nd Part that can be used for even more Rhythm patterns.

A back-up battery is contained to prevent erasing of the memory when the power is turned off. This engages the battery system.

It is necessary to change the batteries once a year to prevent the memory from being erased or distorted. When changing the batteries make sure the TR-808 is plugged in with the power on.

So far we have used many of the TR-808's performance controls to produce creative and interesting results, but a function that completely sets the TR-808 apart from any other device is its ability to Record an entire compositions percussion score (which we call the Rhythm Tack).

A Rhythm Track is Composed (as we call it) in real time, and in much the same way as you have programmed Rhythm Patterns, by using the STEP buttons to change from one Programmed Rhythm to another. We will program a short Rhythm Track from some of the Rhythms you now have in memory.

With the Rhythm Pattern stopped, set the MODE selector to COMPOSE. When this is done, one of the LEDs on the STEP will flash on and off. Now you will see the second function of the INSTRUMENT/TRACK selector. This control is now used to select which of the 12 available memory banks will be used for your Rhythm Track. By setting this control to #1 Track, you will be composing your Track beginning with that memory.

Set the INSTRUMENT/TRACK selector to #1 and press the CLEAR button. This action clears that

memory bank so you can Compose there. Begin your Rhythm Track with the #1 INTRO/FILL IN and then use one of your BASIC RHYTHMS for the main beat. Make sure you VARIATION switches are both set to A, the reason for this will be explained later.

Press the START/STOP button to begin Composing. When this is pressed while in the COMPOSE MODE, every change of Rhythm Patterns will be memorized (up to 768 measures). For now, let the BASIC RHYTHM run for 16 measures or so, changing Rhythm Patterns by switching from one BASIC RHYTHM or 16 measures press the START/STOP button to end the Composing function.

When the START/STOP button is pressed the sound of the Rhythm Pattern may cut off, however the entire Rhythm Pattern will be memorized. If the START/STOP button is pressed before the 16th measure begins or after the 16th measure has been played, the measure where the button was pressed will become the last measure of the composition. Therefore, the exact time that you press the START/STOP button is critical in that it will determine the length of the composition.

## Playback of the TRACK

You have programmed a 16 measure Rhythm Track into Track #1 of the TR-808. To hear the Composition, turn the MODE selector to PLAY and press the START/STOP button. The Rhythm Track will begin, and all your switching you had made between

BASIC RHYTHMS or INTRO/FILL INs will be indicated by the LEDs. At the end of the Track press the START/STOP button. If you don't, the Track will be repeated.

## Memory

The Rhythm Track will memorize the exact number and sequence of the Rhythm Patterns you select, and will also remember how many times each was repeated.

Each of the 12 Tracks will memorize up to 64 measures, and these can be used separately or all together for a maximum Composition of 768 meas-

ures (12 x 64).

Selecting a Track (1-12) for a long composition merely selects which track will be the beginning of the Composition. It is not necessary to manually switch to the next Track once you have used up the 64 measures of memory in the first Track. The switching will be done automatically for you.

## The Variation and Composing

It is important to note that the Variation function (BASIC VARIATION and I/F VARIATION) is a "Play" function only. This means that when Composing Rhythm Tracks, the TR-808 will not memorize the setting of either Variation switch. When you are composing a Rhythm Track and you choose BASIC RHYTHM #5 while the Variation switch is at the "A" Position, the TR-808 will only memorize the fact that it is BASIC RHYTHM #5.

Any Rhythm Patterns recorded on a Rhythm Track will be played back according to the setting of the Variation during playback. Therefore, when playing or recording a long composition where you need all 32 memories, it may be best to begin the piece using only A Mode Rhythms, and mid way through switch to using only B Mode Rhythms so that you will only have to switch from A to B once during playback.

## Editing The Rhythm Track

It is possible to edit your Rhythm Track from a certain point in the Composition onward, so that if you make a mistake you will not have to Re-Compose the whole piece. This is done as follows.

Set the MODE selector to COMPOSE. Choose the Track to be edited and start the Rhythm, but do not press the CLEAR button. When the sequence reaches the measure that you want to replace,

switch to only the Rhythm Pattern you want. But you can not change number of total measure of the Track when Editing. The timing for making the edit switch is exactly the same as the procedure you used in switching between Rhythm Patterns. In the COMPOSE MODE, you will find that you can use the TAP button to insert INTROs or FILL INs, so use the switches themselves as you did with the BASIC RHYTHMS.

## Notes on Composing

If you memorize a blank Rhythm Pattern at the end of the Composition, it will make it easier to stop the TR-808 at exactly the time you want. The blank measure will be memorized exactly like the other Rhythm Patterns.

As in normal Rhythm switching, when you switch

from one Rhythm to another on the first beat, the new Rhythm Pattern will be heard on the second beat. However, this is not what will be memorized. When the Track is played back, the new Rhythm will be heard beginning on the first beat of the measure, not on the second beat as was heard when Composing.

## NOTES:

1. In editing mode, the Fill In or the Basic Rhythm which previously programmed can be replaced by only depressing the Rhythm Select switch for INTRO/FILL IN. Therefore, in case the rhythm sequence has various Fill in rhythm patterns, first of all compose the rhythm track without using Fill In, and then replace the Basic Rhythm pattern with the Fill In rhythm pattern you want in editing mode.
2. In case of programming a rhythm pattern which has two different pre-scale in a measure, this rhythm pattern can be divided into two rhythm patterns. For example, in case a measure has 16 beats and triplets, this rhythm pattern can be composed by programming part of 16 beats and part of triplets into two rhythm patterns independently. That is, in composing, compose these two rhythm patterns as a measure.
3. A Fill In Rhythm pattern which is shorter than a quater note can not be programmed on INTRO/FILL IN. But this rhythm pattern is available by using Basic Rhythm pattern.

	Basic Programming	Programming BASIC VARIATION AB	Programming the 1st and 2nd PART
①	Stop the rhythm with the START/STOP button. Set the MODE selector to PATTERN CLEAR.	★	★
②	Select either the A or B Mode (VARIATION) and create a pattern with the STEP buttons and the VARIATION Switches	Set the BASIC VARIATION Switch to AB.	★
③	Press the CLEAR button.	★	★
④	Set the MODE selector to PATTERN WRITE 1st PART.	★	★
⑤	Press the START/STOP button.	★	★
⑥	Choose the PRE-SCALE.	★	★
⑦	Press the CLEAR button.	★	★
⑧	While pressing the CLEAR button, press the key for steps.	★ ⑧-2) Set the BASIC VARIATION Switch to A	★ ⑧-2) Set the MODE selector PATTERN WRITE and repeat instruction ⑧-1. ⑧-3) Set the MODE selector to 1st PART PATTERN WRITE.
⑨	Choose the instrument with the INSTRUMENT/TRACK selector.	★	★
⑩	Press the steps that are to be programmed.	★ ⑩-2) Set the BASIC VARIATION Switch to B and repeat instruction ⑩-1.	★ ⑩-2) Set the MODE selector PATTERN WRITE and repeat instruction ⑩-1.
⑪	Program the other instrument sounds and ACCENT by repeating instructions ⑨ and ⑩.	Program the other instrument sounds and ACCENT by repeating instructions ⑧-2 to ⑩-2.	Program the other instrument sounds and ACCENT by repeating instructions ⑧-3 to ⑩-2.
⑫	Press the START/STOP button when programming has been completed.	★	★

\*Number 8 is unnecessary in case of Programming of 16 steps.

Play	
①	Set the MODE selector to MANUAL PLAY
②	Select the rhythm pattern you want to play (combination of the BASIC RHYTHM buttons and the BASIC VARIATION Switch)
③	Press the START/STOP button.
Intro	
①	Select the rhythm for introduction with the combination of the INTRO/FILL IN buttons and the I/F VARIATION Switch.
②	Press the TAP button.
③	Press the START/STOP button.
Fill In (MANUAL)	
①	Select the rhythm for filling in the BASIC RHYTHM with the combination of the INTRO/FILL IN buttons and the I/F VARIATION Switch.
②	Press the Tap button at the place in the basic rhythm where you want to fill in the additional rhythm.
Fill In (AUTOMATIC)	
①	Select the rhythm for filling in the BASIC RHYTHM with the combination of the INTRO/FILL IN buttons and the I/F VARIATION Switch.
②	Choose the fill-in passage with the AUTO FILL IN selector.
③	Press the START/STOP button.

Compose	
①	Set the MODE selector to COMPOSE RHYTHM TRACK
②	Choose the Track with the INSTRUMENT/TRACK selector.
③	Press the CLEAR button.
④	Set the STEP buttons and the VARIATION Switches.
⑤	Press the START/STOP button.
⑥	At the last measure of the composition, press the START/STOP button.
Track Play	
①	Set the MODE selector to PLAY RHYTHM TRACK.
②	Choose the Track with the INSTRUMENT/TRACK selector.
③	Set the VARIATION Switches.
④	Press the START/STOP button.

## Memorized Rhythm Number

BASIC RHYTHM A/AB/B 12  
INTRO/FILL IN A/B 4  
Step Number 1 measure  
1-32 steps

RHYTHM TRACK  
64 measures 12 tracks (768 measures)

## The Instruments and Controls

BASS DRUM (BD):  
LEVEL, TONE, DECAY  
SNARE DRUM (SD):  
LEVEL, TONE, SNAPPY  
LOW CONGA (LC):  
LOW TOM TOM (LT):  
LEVEL, TUNING  
MID CONGA (MC):  
MID TOM TOM (MT):  
LEVEL, TUNING

HI CONGA (HC):  
HI TOM TOM (HT):  
LEVEL, TUNING  
CLAVES (CL):  
RIM SHOT (RS):  
LEVEL  
MARACAS (MA):  
HAND CLAP (CP):  
LEVEL

COW BELL (CB):  
LEVEL  
CYMBAL (CY):  
LEVEL, TONE, DECAY  
OPEN HI HAT (OH):  
LEVEL, DECAY  
CLOSED HI HAT (CH):  
LEVEL  
ACCENT (AC):  
LEVEL

## Control Switches, Keys Knobs and Buttons

MODE Selector  
(PATTERN WRITE-1st PART, 2nd PART,  
MANUAL PLAY, RHYTHM TRACK-PLAY, COM-  
POSE, PATTERN CLEAR)  
INSTRUMENT/TRACK selector  
(INSTRUMENT-SELECT, RHYTHM TRACK 1-12)  
TEMPO control (4M = 40-300)  
FINE control  
AUTO FILL IN selector  
(MANUAL, 16, 12, 8, 4, 2)  
BASIC RHYTHM button  
(1-12)  
INTRO/FILL IN button  
(1-4)  
START/STOP button  
TAP button  
(TAP, INTRO SET, FILL IN TRIGGER)  
PRE-SCALE selector  
(1, 2, 3, 4)  
LEVEL control  
(1: ALL RHYTHMS)  
ACCENT LEVEL  
TONE control  
(3: BD, SD, CY)

MASTER VOLUME  
Power On/Off Switch  
CLEAR button  
(PATTERN CLEAR, TRACK CLEAR, PRE-SCALE  
SET, STEP NUMBER SET)  
STEP button  
(1-16)  
BASIC VARIATION switch  
(A, AB, B, indicator A, B)  
I/F VARIATION switch  
(A, B)  
TUNING control  
(3: LC = LT, MC = MT, HC = HT)  
DECAY control  
(3: BD, CY, OH)  
SNAPPY control  
(1: SD)  
VOICE selector  
(5: LC-LT, MC-MT, HC-HT, CL-RS, MA-CP)

## Connection Jacks

MASTER OUT  
HI: 6V P-1k $\Omega$   
LO: 0.6V P-P/3k $\Omega$   
(LEVEL: standard-red mark, AC LEVEL: max)  
MULTI OUT  
BD, SD, LC (LT), MC (MT), HC (HT), CL (RS),  
MA (CP), CB, CY, OH, CH,  
TRIGGER OUT

CB, CP (MA), AC, (+ 15V, 20ms pulse)  
PEDAL SW  
START/STOP (DP-2)  
INTRO/FILL IN (DP-2)  
SYNC In/Out  
DIN Connector (for CSQ-600)  
(1: START/STOP, 2: GND, 3: CLOCK)  
INPUT OUTPUT selector

Power Consumption 8W

Dimensions 508(W) x 305(D) x 105(H)mm

Net Weight 5kg



