

TC 2290

DYNAMIC DIGITAL DELAY + EFFECTS CONTROL PROCESSOR

OWNER'S MANUAL

Authors: Jesper Ranum & Kim Rishøj
Copyright 1986

OF DENMARK

t.c. electronic

CONTENTS

- 1 INTRODUCTION
1.1 How to use this manual
- 2 FEATURES
2.1 TC 2290 Dynamic Digital Delay
2.2 TC 2290 Design Philosophy
2.3 On TC 2290 Sound Quality
- 3 QUICK STEP-BY-STEP TUTORIAL
3.1 Quick Installation
3.2 Set Input Gain
3.3 The Factory Presets
3.4 Recalling a Preset
3.5 Modifying a Preset
 .1 Setting Delaytime
 .2 Setting Feedbacklevel
 .3 Storing Your Own Presets
 .4 Setting Volumes
3.6 Three Kinds of Modulation Effects
3.7 Making Dynamic Effects (dyn)
3.8 Making Chorus/Flanger/ADT Effects (dly)
3.9 Making Panning Effects (pan)
3.10 Tailoring TC 2290 to your own requirements
3.11 The 10 Presets You Have Made

REFERENCE GUIDE CONTENTS

- 4 INSTALLATION
- 5 FRONT PANEL DESCRIPTION
- 6 REAR PANEL DESCRIPTION
- 7 TC 2290 COMMANDS LIST
- 8 PERFORMANCE HINTS
8.1 MIDI with TC 2290
8.2 Sampling
8.3 Options
- 9 APPENDICES
9.1 Factory Presets List
9.2 Modulation Charts
9.3 Block Schematic
9.4 Special Number List
9.5 Assign Keycode List
9.6 Technical Spec.
- 10 TROUBLESHOOTING, SERVICE
- 11 t.c. electronic APPLICATION NOTES
- 12 GLOSSARY

1.0 INTRODUCTION

Thank you purchasing the TC 2290 Dynamic Digital Delay and Effects Control Processor.

You have become the owner of a very capable & flexible piece of equipment with absolute superior sound quality.

1

1.1 How to Use this Manual

This is a thick manual, but you don't have to read it all in order to get very good usage of the TC2290. Regard it rather as a manual you can consult when you need to.

To get started there is the **quick tutorial** which shortly explains how to set-up the TC 2290, its basic features, some of the **factory presets** as well as giving you 10 further preset sounds through a number of small rehearsal setting examples.

Any time you want to find out more about a specific subject you can refer to the **reference guide** where the controls, connections and practical use of the TC2290 are explained in greater detail.

The **appendix** chapter contains lists which you need to consult in order to make optional settings (special) and program your own keys, the Assign Keys.

In the t.c. electronic **application note** section you will find more about selected applications, the TC2290, the effects, practical performance set-ups and hints, personalization of the TC2290 as well as some general notes.

Ending the manual is a **glossary**, which will help those of you having trouble keeping up with some of the 'technical' terms.

1.2 Keynames and References

The frontkeys appears by <Keyname> in brackets e.g. <DELAY ON> or <ENTER>.

Sometimes you need to make a cross-references to find out more about a subject. For example [4.3] is chapter 4, section 3.

And hey - Good luck. Don't be 'delay'ed by our smalltalk.

2.0 FEATURES

TC 2290 Dynamic Digital Delay

Soundquality, Studio and Stage

The 100 dB dynamic range, 20-23000Hz **soft** roll off frequency response and 1 MHz samplerate are part of the t.c. electronics design philosophy. In the studio it means no compromise where recordings for compact disc are concerned, and to the performer, the 100 dB dynamic range means crystal clear sound, eliminated hiss and the headroom for all the 'punch' needed.

TC 2290 Effects

The TC 2290 features a large number of dynamic echo effects allowing you to add delay echo and repeats controlled by your playing. Numerous delay modulations allows you to create exiting chorus, ADT, synchronized flanging, even chorus effects on long delaysettings. The stereo panning facilities create new ways of using the stereo image dynamically. Also the modulation effects can be made simultaneously to make effects like a 'dynamic echo chorus with stereo panning'.

An Effects 'System'

The built-in connections to control other equipment enables very practical 'total' performance systems to be set up, controlling all the TC 2290 delay effects simultaneously with 5 external effects racks or pedals as well as MIDI controllable effects (& keyboards). All of it is remote-controllable with simple 'press a button' commands from e.g the TC 0144 SRC stage remote control panel.

100 Preset Sounds & Personal Control

All music performers come across the wish to make some specific change of settings 'at the push of a button'. 100 Preset sound combinations certainly helps doing easy changes. But often there is more to it. 'I would like a simple remote delaytime setting button', a 'bypass' or maybe a 'change volume key'. That is why we have included a number of 'programmable' keys and personalization facilities. This also means that any key(s) on the front of the TC 2290 are readily made remote keys when you need.

New Effects, Half a Minute Delay and other options.

The software control of the TC 2290 and membership of the TC Software Club will allow you to add new effects and controls with the TC 2290 through the simple change of a low cost 'softwarechip'. The TC 2290 has the facilities for adding options like **half a minute** delay memory with **no** sacrifice in soundquality, connections to your needs whether it be remote controls, computer sequencer or control, or maybe the next generation of MIDI.

Sa'Sa'Sampling'ampling'ampling (option)

With extra memory for longer delaytimes fitted, the sample record and playback option really becomes a usefull tool for recording, modifying and playing back sequences of sounds live and in the studio. Up to 100 preset samples can be recorded and played back in various extractions. When shifting back and forth between delay echo and sample effects, the sampled sounds can remain unaffected 'in memory'.

2.1 TC 2290 Design Philosophy

Soundquality

At t.c. electronics we realised that there is a genuine need for a digital delay capable of meeting the studio demands for compact disc quality recordings. Also for live performances a high quality delay unit were missing. A delay unit capable of doing better than 'hiss and clip' of the precious details and the 'punchy' parts of live-music. The vital soundquality of the TC 2290 was specified.

Integrating Effects

A tendency within digital audio equipment is an ever increasing complexity, not only in the effects provided but also in the control of them.

What was lacking was the means to integrate previous, new and coming effects into a 'system' that can be set up and used in a simple and troublefree manner. The inclusion of the external effects control, the TC LINK and MIDI provided the answer to this.

The Future

We also found that there is a need for a piece of equipment, that is capable of lasting longer than the typical short product lifetime of most delay units.

Software programmability of all TC 2290 effects and control and the facilities to add hardware options provided the answer to this.

With low-cost software, adding new effects and interfaces is possible. Effects and interfaces with capabilities beginning to appear limitless as time goes by.

The 32 seconds optional delaytime for sampling possibilities is a 'hardware' option example, others are future interface possibilities through a built-in option-bus connector.

Reliability

Finally the TC 2290 had to be able to meet the stringent demands of an on-the-road life or 24 hour studio use for many years. This called for a durable construction with reliable topquality components for a lasting and troublefree operational lifetime. Easy serviceability through full documentation (Service Manual) fault-diagnostics software and easy identification of components.

2.2 More On TC 2290 Sound Quality

See application note 2290-apn.01

3.0 A QUICK STEP-BY-STEP TUTORIAL

You want to get started without reading the whole manual.

That's why we made this little guide, which will take you to the heart of TC 2290 functions quickly and with little effort. You will end up having made 10 presets of your own.

Whenever you want to find out more about a specific subject you can refer to the **Reference Guide Part** of this manual

Check Voltage Setting

This should be set to the standard of your country. The guarantee does **not** cover damages caused by improper installation, so check this properly. Remember you can find out more about installation in sec. [4.0].

If the voltage setting is OK then connect the mains cord and switch on the <POWER>. All displays light up and the last accessed preset # automatically appears.

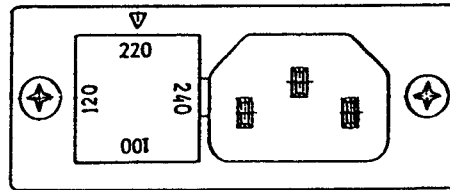

Fig.3.0 Here a voltage selection of 220V is shown. (Indicated by the small arrow). 110V users should use the 120V setting.

3.1 Quick Installation with a Musical Instrument

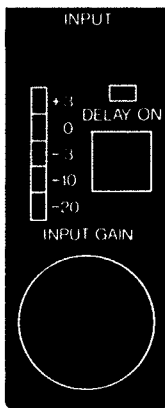

Fig.3.2

Plug in your instrument to the <JACK INPUT> on the rear panel. Output to your amplifier is taken from the <JACK OUT LEFT> if mono. If you want to use the exciting stereo sound possibilities of the TC 2290 then also connect the <JACK OUT RIGHT> to the input of your second amplifier.

3.2 Set <INPUT GAIN> Correctly

Turn up the volume of your instrument and turn down the volume(s) of your amplifier while the <INPUT GAIN> is adjusted so that the red LED (+3dB) of the PPM meter **only flashes during the very strong passages** of your playing. Now set the volume(s) of your amplifier(s) to your level (and equal levels if stereo).

3.3 The Factory Presets

We have shipped the TC 2290 off the factory with 20 useful presets, which are present at the Preset Numbers 80 to 99. All presets below 80 are non-protected copies of preset 80 and are available for your own presets.

In this section we will use some of the factory presets to take you quickly through many of the TC 2290 functions.

In appendix [9.1] you will find a list covering the factory presets.

3.4 Recalling a Preset

To recall preset 80, press:

<PRESET> <8> <0> <ENTER>

Note that when the **<PRESET>** key is pressed, the green LED above the **<PRESET>** key starts blinking. This shows that the numeric keyboard is now available for the preset function. When entering the **<8>** and the **<0>** on the numeric keyboard the values '8' and then '80' are shown blinking in the preset display. Nothing happens to the sound until you terminate by pressing the **<ENTER>** key.

At the moment you press **<ENTER>** all displays and settings change to the values of preset 80.

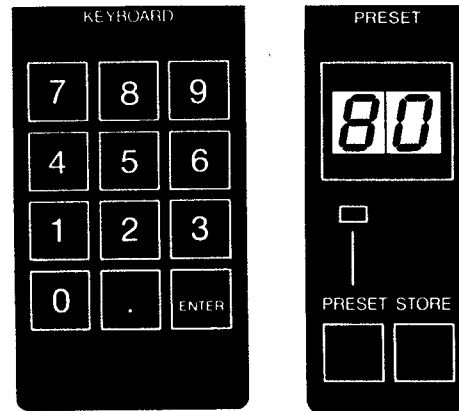

Fig.3.4 Numeric Keyboard and the Preset Section

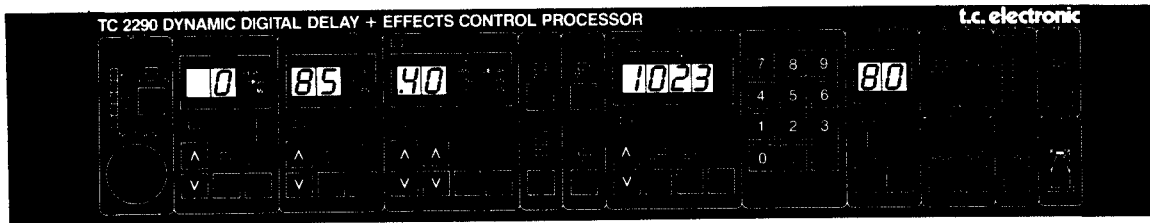

Fig.3.5 The displays of preset 80, a 'long echo' effect with the delaytime of 1023mS.

Now the preset is recalled. If your connections are properly made, you should hear a 'long echo' effect as a single repeat of all that you are playing.

Please note that the delay signal appears with equal strength but phase reversed to left & right channel in this preset. To make the delay signal appear with equal phase to left and right outputs, the »DELAY« and »DIRECT« led of the panning section must be lit, and the »PAN« value in the output section must be 50. More about this in section 5.5.5.

Turning Delay Effects On/Off (Bypass)

Simply press the **<DELAY ON>** key. (fig.3.2)

When you turn off the delay effect the echo immediately 'stops'. Note that there is, unlike most other delays, no repeat of what you've just played when turning on the delay.

Also, imagine that you are playing with a long echo, and the echo did not stop immediately when bypassing, but finished the echo repeat. This and other useful methods of bypassing are possible with your TC 2290. But take it easy, we will try more important things first.

3.5 Modifying a Preset

As soon as a preset is recalled, you can make instant changes to any of the parameters you want. You can then either choose to 'forget' these changes (just recall another or the same preset again) or you can store your modified settings under a user preset number. For now we will try making some modifications of preset 80 and store those changes in preset #1.

3.5.1 Setting Delay Time

The delaytime of preset 80 is 1023 milliseconds (1.023 seconds) and we will assume that you want to decrease this to make a shorter echo delay time, say 400 mS.

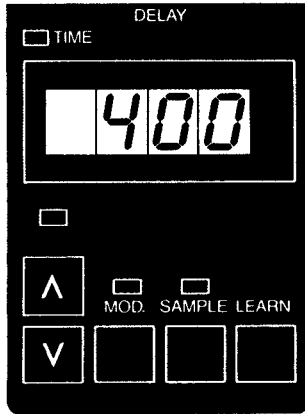

Fig.3.5.1 The Delay Section

Using the <UP>/<DOWN> keys

In the DELAY section you must press one of the <UP>/ <DOWN> keys. Pressing either of them once makes the green LED above the <UP>/<DOWN> start blinking.

Now by pressing <DOWN> the delaytime decreases a 'step' (1 millisecond = 1/1000 second). Holding the <DOWN> key the value will continue decreasing as long as you hold or until '0' is reached.

Similarly pressing <UP> increases step-wise when pressed or continuously when hold.

TC 2290 can '<LEARN>' the Beat

To set the delaytime to the rythm, simply press the <LEARN> key at the beat-rate. The delaytime will be set to the time elapsing between your pressings.

The yellow TIME LED indicates this beat or echo repeat rate.

Using the Numeric Keyboard

You may find it valuable and faster to use the numeric keyboard to change to a specific delaytime. As soon as one of the DELAY <UP>/<DOWN> keys are pressed the green LED above starts blinking, showing that the numeric keyboard is available for this function.

So instead of holding the <UP>/<DOWN> keys, you can enter an exact value on the numeric keyboard.

For example to change to 400 mS delaytime :

- | | | |
|------------|---|--|
| Press : | ; | Comments: |
| <DELAY UP> | ; | tells 2290 that the Numeric Keyboard is wanted for this function'. |
| <4><0><0> | ; | Green LED starts blinking, to show 'keyboard available' |
| | ; | Now enter the delaytime wanted on the Numeric Keyboard, |
| | ; | the Delaytime Display shows what you are entering. |
| <ENTER> | ; | The moment you press <ENTER> the value is accepted. |

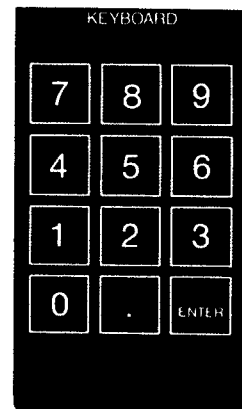

The green LED continues blinking indicating that the numeric keyboard is still available for the delaytime setting, so you could enter another value, terminated by <ENTER> if you wanted.

For now let's stick to the '400mS' setting so that we're talking about the same 'sound' as we continue.

3.5.2 Setting Feedback Level

Assuming you have succeeded in making the '400mS' delaytime, which is a medium echo time, a shorter single 'echo repeat' should now be audible. It is a straightforward echo effect without any modulations or feedback. Now, to give the sound a bigger impression we will make the echo repeat a number of times instead of just once.

The parameter taking care of this is the FEEDBACK LEVEL. With this control the delay echo output is fed back to the input of the delay to make the echo 'recirculate' or 'repeat' a number of times. Since we want more repeats we now go to the 'FEEDBACK SECTION' (- strange isn't it ?) and find the value ' 0' which means 'no feedback'.

The Feedback 'LEVEL' is <SELECT>'ed

Note that there is a '3 point' display above the <SELECT> key : 'LEVEL', 'HIGH' & 'LOW'. The point corresponding to 'LEVEL' is lit showing that we are looking at the FEEDBACK LEVEL.

The '3 point' display covers the fact that the feedback section <UP> /<DOWN> keys and display are also used to set the 'colour' of the repeats of the echo by setting the HIGH and LOW feedback filters.

For now we want to set the feedback LEVEL and this is <SELECT>'ed alright. If you have pressed <SELECT> by mistake then press again until the 'LEVEL' is selected.

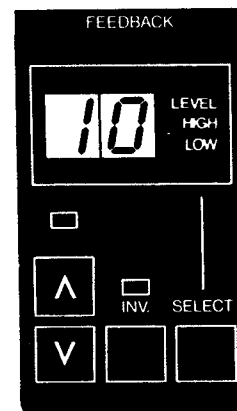

Fig.3.5.2 The Feedback Section

Using the <UP>/<DOWN> Keys

As the current Feedback Level of preset #80 is ' 0' it can't get much lower, so press the feedback section <UP> key a number of times to get more feedback. The value increases by one each time you press the <UP> key. Reaching a value of '10' a second repeat of your echo will be audible. By holding the <UP> key until '55' is reached several repeats will be clearly audible.

Using the Numeric Keyboard to set Feedback Level

Let's say you want the Feedback Level to be '50'. Using the numeric keyboard is a fast way to set this:

Press :	; Comments:
<FEEDB.UP>	; tells 'Numeric Keyboard is wanted for this function',
	; green LED starts blinking, to show 'keyboard available'
<5><0>	; enter the feedback wanted on the Numeric Keyboard,
	; the Feedback Display shows what you are entering.
<ENTER>	; The moment you press <ENTER> the value is accepted.

Notice the similarity to the Delaytime setting using the numeric keyboard. Any <key> below a green LED is capable of 'catching' the keyboard in order to enter exact values. No values are 'entered' unless you remember to terminate with the <ENTER> key.

If you are on the right track your display should now look like this:

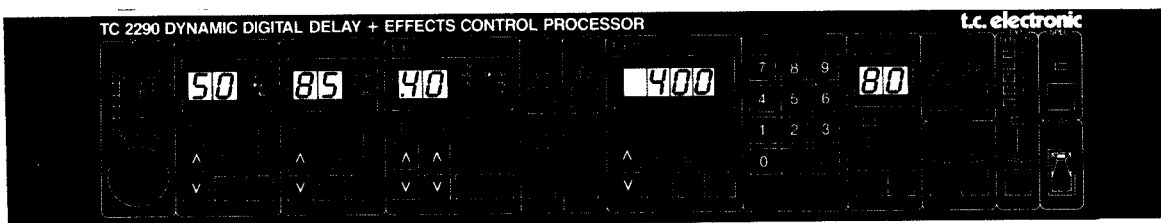

You have now created a 'medium/fast' echo effect with several repeats.

3.5.3 Storing Your Own Presets

We will now store (in preset no 1) the settings that you have just created. To do this we use a key sequence similar to recalling a preset except that <STORE> is pressed instead of <ENTER>:

Press :	; Comments:
<PRESET>	; to get the Numeric Keyboard for this function,
	; green LED starts blinking, showing 'you've got it'
<1>	; Now enter the preset # on the Numeric Keyboard,
	; the Preset Display shows the numbers you are entering.
<STORE>	; When you press <STORE> the frontsettings are stored.

The moment you ended the store sequence by pressing <STORE> a new preset 1 was created, and the current preset number changed to preset '01', your new preset.

Now that you have stored your settings you can explore with other settings, before you continue. But,- don't store another setting into preset 1 just yet as you will need this when you continue.

Unsuccessful Store

If you omit the <PRESET> key in the store sequence the error # 4 (which means 'wrong store sequence') will appear in the delay time display. If you try to store in the presets 80-99, you will get error # 3 which means 'preset protected' - the presets are protected against store attempts. Just store your sound in another preset below '80'.

More about Store & Recall

You can find out more about storing/updating/copying and moving presets in the reference guide, where you will also find more about recalling presets [5.9].

With a so called 'special number' the number of presets that are protected can be altered - more about this in appendix sec.[9.4]

3.5.4 Setting Volumes

You might wonder how you can change the output volume of the echo signal. This is done in all ready guessed ? - the OUTPUT section.

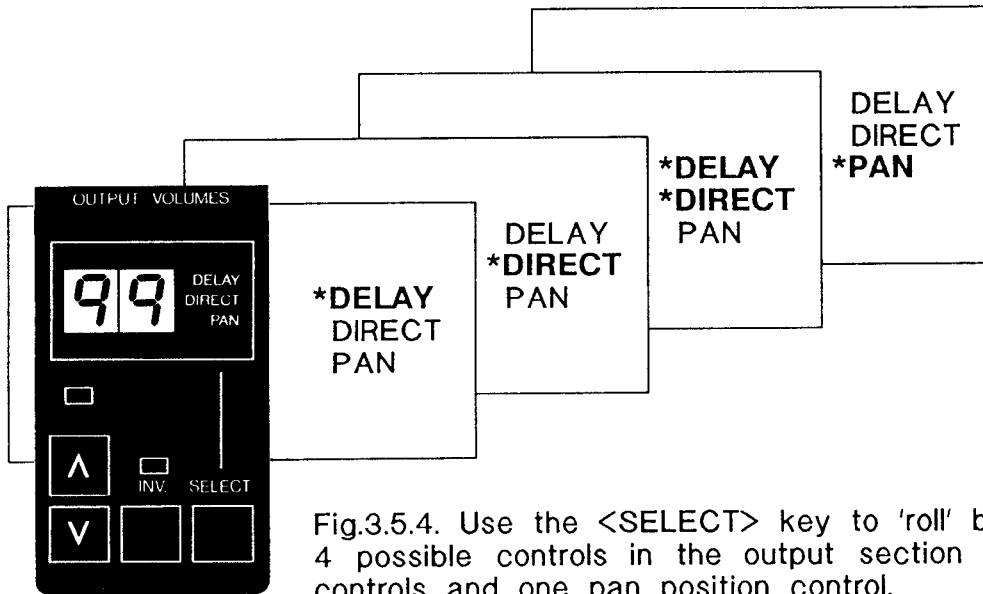

Fig.3.5.4. Use the <SELECT> key to 'roll' between the 4 possible controls in the output section - 3 volume controls and one pan position control.

The Output Section features independent control over direct and delay output volumes as well as a total output volume control (DIRECT and DELAY LED's are lit)

The 4. control is the static pan position of output panning circuitry. **Note** that at least one of the LED's <DELAY/DIRECT> in the PAN Section must be lit for **any** pan positioning to have effect. We will return to the static pan positioning later.

Setting Echo Level

To set the delay echo level simply press <SELECT> until the 'DELAY' (volume) LED is lit. Then use the <UP>/<DOWN> keys to change the value.

You can also change the volume using the numeric keyboard :
Pressing one of the <UP>/<DOWN> keys makes the keyboard available (green LED flashing...) for entering a value.
E.g. <9> <0> <ENTER> to get a lower delay volume.

Setting Total Output Volume

TC 2290 features the total output volume control. To set this press <SELECT> until the 'DELAY' and 'DIRECT' LED's are lit. Then use either the <UP>/<DOWN> keys to change the value or press <UP> and use the numeric keyboard
Note that the total output volume also sets the total output volume when bypassing.

3.6 Three Kinds of Modulation Effects

The TC 2290 features 3 different kinds of modulation effects:

-
- | | |
|--|--|
| 1. Delaytime modulations | for chorus, flanger, pitchmodulation and ADT effects |
| 2. Dynamic (volume) modulations | for tremolo, compress-, expand-, duck- and gating effects. |
| 3. Panposition modulations | for 'autopanning' effects. |
-

Each of these 3 modulations has it's own <MOD>'ulation on/off key - the <DLY-MOD> key in the DELAY section, the <PAN-MOD> in the PAN section and the <DYN-MOD> key in the DYN section.

Should you want, all 3 <MOD>'s can be turned on simultaneously !

3 Independent Sets of Modulation Parameters

Modulation of the delaytime, the dynamics and the panposition is controlled by 3 independent sets of modulation parameters in the MODULATION section.

A modulation parameter set is : Choice of WAVEFORM, SPEED and DEPTH

If this sounds like 'too much' - don't worry - you'll soon find yourself at home with the modulation effects.

We'll go straight to the 'heart' of the Dynamic modulations first.

3.7 Dynamic Effects

Let's 'Synchronize'

To make sure we are working on the same preset, recall the preset that you have just made:

Press <PRESET> <1> <ENTER> - which should give you (if you ever left it), your own version of preset 80 with a delaytime of 400mS and a Feedback level of '50'.

We now want to use the dynamic modulation 'ducking' effect, so that the echo effect will be 'ducked' (lower volume) while you are playing and will reappear when you stop playing.

Technically this is achieved by modulating the delay echo volume with the envelope (the average level) of the input signal.

In musical terms it means that the harder you play, the less audible the echo will be and when you stop playing the delay echo effects return. This is a clever way of achieving some nice 'echo tails' without the usual 'muddy' echo sound when playing with a high echo feedback setting.

3.7.1 <SELECT> DYN in the MODULATION Section

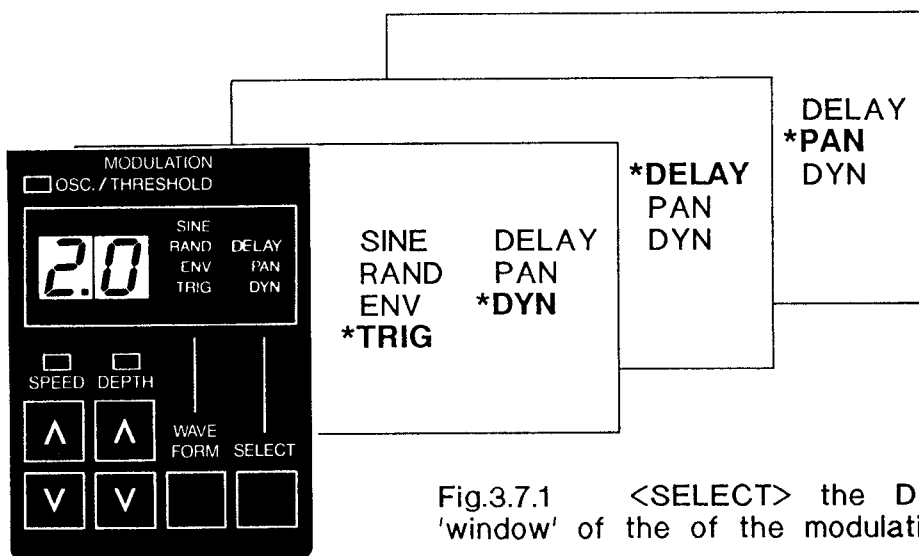

Fig.3.7.1 <SELECT> the DYN parameter 'window' of the of the modulation section.

Press <SELECT> in the modulations section (twice, if we are synchronized) until the display above <SELECT> reads 'DYN'. Now we can set the dynamic modulations.

Check that the waveform display shows 'TRIG'. If not then press <WAVEFORM> until the 'TRIG' is selected. The dynamic modulation has now been set to the 'ducking' function.

3.7.2 <MOD> Enables the Dynamic Modulation.

All dynamic modulations are controlled **on/off** by the <MOD> key in the DYN section. So, press the DYN section <MOD> key ON (LED is lit).

Play your instrument and the DYN effect should be clearly audible. The delay echo is suppressed while you are playing and reappears gradually

when you pause. This effect is very useful avoiding 'muddy or confused' output when playing fast passages or chords.

The **depth** of the modulation effects are always controlled by their <DEPTH> parameter, and their **rate** by the <SPEED> parameter. In this DYN TRIG case how fast the 'ducking' ends after you pause playing.

3.7.3 Changing <DEPTH> of Dyn. Effect

Now try changing the <DEPTH> of the effect. The current value is '35', which can be monitored by pressing the <DEPTH> key shortly. The depth value appears in the display above. Note that when you pressed the <DEPTH> key the green LED above started flashing, indicating - can you guess - okay let's repeat that the numeric keyboard is now available for this function.

Now enter '99' on the num. keyboard and - remember - press <ENTER>. The ducking effect should now become stronger, practically removing any delay echo while you are playing, but returning to full echo effect when you pause or stop in your playing.

3

3.7.4 Changing <SPEED> of Dyn. Effect

You may have noticed that it takes a little while for the delay-echo to reappear after you've stopped playing. The <SPEED> control can regulate this. Technically, with this 'ducking' effect, it is called the 'release' time (see Glossary for more about release).

Press the <SPEED> key, which will cause the the current <SPEED> value '2.0' to be shown (...and a green LED above <SPEED> starts flashing ...). The value '2.0' is a medium speed. To give the release a very slow speed, try entering '0.1' on the num. keyboard : <SPEED> <.> <1> <ENTER> (note that the 'leading zero' can be omitted when entering numbers less than '1') Now the echo effect hardly reaches full level before the echo-repeats have died out.

Also try entering a 'fast' <SPEED> value of '10': <SPEED> <1> <0> <ENTER>. Now the echo reappears almost instantly after you pause or stop playing.

Your 2.nd preset sound: Dyn. Ducked 400ms Delay
Adjust the <SPEED> and <DEPTH> to your taste and store the sound in preset #2. Press:
<PRESET> <2> <STORE>

3.7.5 <REVERSE>'ing the Dynamic 'Ducking' to get Dynamic 'Gating'

You can easily 'reverse' the dynamic 'ducking' with a single keystroke. In this way the delay-echo effect will only be audible WHILE you are playing. Simply press the <REVERSE> key in the DYN section. This effect is called 'gating'. With this effect you can create gated delay effects, which is good if you e.g. are playing a solo and the key must suddenly change. You still have the full effect of your playing, but the echo'd notes of the last bar won't linger on in the next bar.

Changing the 'Gating' <SPEED>

If you did not change it, the current <SPEED> value is '10' which means that the delay echo will disappear very quickly after you pause or stop playing. Let's try making the echo linger a while after you've stopped playing.

Press <SPEED> to make the green LED start flashing. Enter '2' and ... (<ENTER>). The delay echo now 'hangs' a little after you stop playing, although it is still cut off rather fast. Decreasing <SPEED> value further will make the release speed slower.

Normally the <FEEDBACK> parameter controls 'the number of repeats'. However note that this gating function 'cuts off' the repeats as you stop playing.

The selected <WAVEFORM> 'TRIG' 'ducks' or 'gates' the feedback as well as the delay echo level.

Your 3.rd preset sound: Dyn. Gated 400mS delay

Adjust the <SPEED> and <DEPTH> to your taste and store the sound in preset #3. Press:

<PRESET> <3> <STORE>

3.7.6 Other <WAVEFORMS>

Feel free to experiment a little with the other waveforms of the dynamic modulation functions.

SINE & RAND gives Tremolo Effects

The 'SINE' and the 'RAND' (random) waveforms produce 'tremolo'- effects on the direct signal level as well as the delay echo level. If <REVERSE> is OFF the tremolo volume modulation is done in a synchronous manner. With <REVERSE> ON, the direct level is up while the delay level is down and vice versa.

The factory preset #93 is an example of a pure tremolo effect setting. Press: <PRESET> <9> <3> <ENTER>.

Your 4.th preset sound, Tremolo

Adjust the <SPEED> and <DEPTH> to your taste and store the sound in preset #4. Press:

<PRESET> <4> <STORE>

ENV gives Compressing and Expanding

The 'ENV' waveform selects compressing of the delay level in a manner similar to the 'TRIG', but more 'softly' and the Feedback parameter is not affected.

With <REVERSE> ON, the 'ENV' waveform produces a modulation to form an 'expand' function similar to the 'ENV'+<REVERSE>' choice. However, both the **direct** and **the delay** level are affected. This allows the possibility of an 'attack-kill' effect. - Here <SPEED> controls how fast the signals appear

3.8 Chorus/Flanger/ADT Effects

And now to something completely different. The TC 2290 can also be used to produce some very nice delaytime modulation effects such as Chorus, Flanging and ADT (automatic double track). Quite short delaytimes are used for these effects, so that the 'delay' is not experienced as an echo but rather as an extra, synchronized voicing. But delaytime modulation can be applied to longer delaytimes to produce what we would call 'delayed' chorus effects.

Some typical delay times and feedback levels are tabulated here.

Delaytime	Effect	<MOD>	Feedback Setting
0-10	Flanger	ON	Quite High
5-50	Chorus	ON	Slight or none
20-80	Double Track	ON	Slight or none
100-up	Delayed Chorus	ON	To set 'repeats'

The 'key' to enable delaymodulation effects is the <MOD> key in the Delay section.

3.8.1 Making a Chorus Effect

We will use our preset '1' again as the base for making a chorus setting. Recall preset 1 (which you haven't destroyed yet ?). Press : <PRESET><1><ENTER>. Now we are back at the delay time of 400mS, with no modulations - (no <MOD> keys should be on).

To get a chorus effect we want to decrease the delaytime to say 25mS. Press : <DELAY UP> <2> <5> <ENTER>. This changes the sound suddenly, and gives it a somewhat more 'bathroom' sound or a rather static 'flanger-like' sound. So remove the feedback, press : <FEEDBACK UP> <0> <ENTER> to set zero feedback.

Now press the <MOD> key in the **DELAY** section to enable delaytime modulation, which gives a chorus effect.

3.8.2 What is a Chorus Effect ?

The chorus effect is simply a 'mix' of the direct signal and a modulated short delaytime. The sound is characterized by a 'moving space' or 'multivoice' character, as if more instruments were being played simultaneously - hence the name 'chorus'.

When the <MOD> key of the DELAY section is on, the delaytime is not just that shown in the delaytime display. It changes up and lower. When delay and direct signals are mixed, the changing delaytime creates the movements of the chorus sound. A slight pitchshift also occurs, just as if you were changing the playback speed of a taperecorder up and down.

3.8.3 Changing the Chorus Effect

To change the settings of the chorus effect go to the MODULATION section and select the DELAY modulations by pressing <SELECT> a number of times until the DELAY (short for delaytime) is selected.

The 'intensity' of the chorus effect is set with the <DEPTH> parameter, which controls how much the delaytime is changed. The <SPEED> parameter controls the speed of the modulation sweep.

<DEPTH> of the Chorus Effect

We will now try changing the 'intensity' of the chorus effect by changing the <DEPTH> parameter.

We can change the <DEPTH> of delaytime modulation by pressing <DEPTH> once to see the current <DEPTH> value and get access to the numeric keyboard (green LED flashing...).

The display will show '35'. Now try entering a higher value, say '60' on the numeric keyboard (<ENTER>) and observe the more pronounced chorus effect.

Your 5th preset sound, Chorus

Adjust the <DEPTH> to your taste and store the sound in preset 5. Press:

<PRESET> <5> <STORE>

Changing <SPEED> of the Chorus Sweep

Try for example changing the <SPEED> to '6'. Press <SPEED UP> <6> <ENTER>. This will give you a 'vibrato-like' sound. The speed number '6' simply refers to the number of sweep-cycles each second. So '6' means that there are 6 cycles per second, whereas '.50' means half a cycle each second (one whole cycle appearing every 2 seconds).

3.8.4 Pure Delay-Vibrato

If you changed the volume of the DIRECT signal to zero, a pure 'vibrato' sound would be the result.

To set the DIRECT signal volume to zero, we go to the OUTPUT section and press <SELECT> a few times until only the 'DIR' volume has been selected.

Then press the OUTPUT section <UP> key (to get numeric keyboard access..), followed by <0> <ENTER>.

You can try experimenting with other <DEPTH> and <SPEED> settings to make the 'vibrato sound' of your preference.

3.8.5 Making a Flanger Sound

Changing tape-recorder playback speed is exactly what was done 'in the old days' to make chorus/flanger like effects. This was done by touching the 'flange' of the feeding tape-reel. Hence the name 'flanging' appeared.

Nowadays flanging typically refers to a more 'resonant' sometimes even 'metallic' or 'jetlike' chorus sound.

We will try making some typical flanger sounds.

We will use our recently made chorus-sound which we stored in preset 5 as the base for a flanger sound. <PRESET> <5> <ENTER>

Try put some feedback to this chorus-sound. Press <FB UP> and then enter e.g. '50' on the keyboard.

The more resonant you want the flanger-sound to be, the more feedback you should apply. Take care not to put too much feedback (not above say '90') otherwise you will get a nasty 'howling' sound.

To get a more 'jetlike' flanging the delaytime must be lower. Try changing delaytime to say 2mS. Press <DELAY UP> <2> <ENTER>. - Right ?

A slower sweep-speed would make the flanging more pleasant. Go to the MODULATION section (check that 'DELAY' modulation has been <SELECT>'ed) and try slowing down the <SPEED>. Press <SPEED DOWN> until the value can no longer decrease. This value is 0.10. (1/10 of the sweep is done every second, or to put it in other words, the whole sweep takes 10 seconds. Also note that the value displayed is '.10' i.e 0.10 and not '10', which is a speed 100 times faster).

The sweep speed can also be seen on the yellow SPEED/THRESHOLD LED which turns on/off as the sweep goes up/down.

Maybe you would also like to increase the <DEPTH> of the delaytime modulation to get a wider sweep : Press <DEPTH UP> <9> <9> <ENTER> to try.

If you play a somewhat 'distorted' or 'thick' sound the flanging effect will be very pronounced. Experiment with the <SPEED>, <DEPTH> and feedback parameters to get a flanger sound you like.

Your 6th preset sound, Flanger

Adjust the <SPEED> and <DEPTH> to your taste and then store the sound in preset 6. Press:

<PRESET> <6> <STORE>

3.8.6 Other Waveforms

With the 'RAND' waveform you get a random sweep instead of the continuous form of the 'SINE'.

The 'ENV' produces a 'RAMP' which start/stops with the input level and can be used e.g. when playing 'funky' type of music. The <SPEED> parameter might need to be set somewhat higher. Adjust the <DEPTH> to your taste.

If you chose 'TRIG' you will get a sine sweep that stops each time you stop playing. In this way you can 'synchronize' the sweep to the music.

Bypassing the TC 2290 or turning off <DLY MOD> in the DELAY section also stops the sweep, making it start at the same point when you again press <DELAY ON> or <MOD> on.

3.8.7 Making an ADT Sound

The idea of an Automatic Double Track sound is to be able to make a live performance 'dubbing' of e.g. a voice. The TC 2290 features 5 parameters which help make this realistic. A slight delay (20-80mS), a slight feedback, a slight random pitchshift of the voice, a slightly changing volume difference, and the position of the voices in the stereo field. The factory presets 95 and 97 are examples of this.

To recall preset #95, press <PRESET> <9> <5> <ENTER>. Note that all the <MOD> LED's are lit in preset #97
Choose the ADT sound you prefer, make some changes if you want and then

Your 7th preset sound, ADT

Press:

<PRESET> <7> <STORE>

3.9 Making Panning Effects

Until now all the effects you have been through could have been in mono, although they sound best in stereo.

To exploit the stunning stereo panning capabilities of the TC 2290, however, you **have to have** a **stereo** set-up with a stereo amplifier or two amplifiers connected to the Left/Right outputs.

If you do **not** have a stereo set-up, take care never to press the <DELAY/DIRECT> key of the PAN section. In this way no stereo-panning ever takes place. You can also skip the rest of this 'panning' chapter.

3.9.1 Panning a Delay Echo

To make some panning effects let's take your 400mS echo preset # 1 again.

You are now quite familiar with the preset recall procedure (?), so we won't tell you how. Allright then : Press <PRESET> <1> <ENTER>. - But that was the last time !

3.9.2 Chose What to Pan

In the PAN section you can decide whether you want to pan the DELAY, the DIRECT or both signals. This is done with the <DELAY/DIRECT> key in the PAN section.

Pan the Delay Signal

Simply press the <DELAY/DIRECT> key of the PAN section once to make the 'DELAY' LED light up. The delay echo suddenly appears in the LEFT speaker only.

Pan the Direct Signal

Now try pressing the <DELAY/DIRECT> key again to make 'DIRECT' LED light up, You will now hear the direct signal in the RIGHT speaker, and the delay echo in both speakers.

Pan Both Signals

Press the <DELAY/DIRECT> key once again to make both LED's light up. Both signals are now panned conversely, so that the delay echo is in the RIGHT speaker while the Direct signal is in the LEFT speaker.

NOTE:

At least one of those two LED's must be lit for any kind of panning to take place.

3.9.3 Changing Fixed Pan Position

Press the <SELECT> key in the OUTPUT section until the 'PAN' position is selected. The display now shows '99'. Now press the OUTPUT section <UP> or <DOWN> key and enter '0' on the keyboard : <0> <ENTER>.

Now the position of the direct and delay signals are interchanged so that the delay signal is now in LEFT and DIRECT is in RIGHT.

3.9.4 Automatic panning effects

Imagine that the above panpositioning pan positioning possibilities could be done automatically as well !

This is precisely what the last of the three kinds of modulations is about. The TC 2290 features automatic 'modulation of the panpositioning' as well as the above 'static' pan position possibilities.

Press Pan <MOD>

To make automatic panning just press the <MOD> key of the PAN section. You will now hear the delay and direct signals travel back and forth from one speaker to the other, crossing each other at the center during the sweep.

Chose What to Pan

In the PAN section you decide whether you want to pan the DELAY, the DIRECT or both signals. This is done with the <DELAY/DIRECT> key. Try pressing <DELAY/DIRECT> key so that only the DELAY signal is panned. We will now try making the panning movement faster.

3.9.5 <SELECT> the PAN Modulation Settings

The auto-panning stereo-width and speed is controlled by the values of the 'PAN' modulation parameters set in the MODULATION section.

Let's find this set of parameters. Go to the MODULATION section and press <SELECT> a number of times until the 'PAN' is selected.

Pressing <SPEED UP> once will give us the panning speed, which is 0.50 Hz. Pressing <DEPTH> once display the pan-modulation depth of '99', which corresponds to a complete left-right panning.

3.9.6 Changing <SPEED> of the panning

We will now try making the pan-movements faster, - guessed how ? Right - press:

<SPEED UP> ; gives us numeric keyboard access, green LED starts ...
<4> ; we'll try a fast speed - '4' is faster than '.50'
<ENTER> ; always <ENTER> to terminate a parameter change
(except when we <STORE> and when we are in the
SINGLE KEY PRESET SHIFT MODE).

The panning movement will now be considerably faster, with the echo moving from side to side. Try experimenting with other <SPEED> settings.

Your 8th preset sound, Panned Delay

Adjust <SPEED> to your taste and then store the sound in preset 8. Press:

<PRESET> <8> <STORE>

3.9.7 DEPTH parameter.

Try panning both signals again, and try making the <DEPTH> value smaller. At '99' the panning goes to the extreme left and right, at '50', the panning is only 'halfway', so that the direct and the delay parts of the signal 'meet' in the middle during the pan-sweep.

3.9.8 Left-Right Switching Dependant on the Input Envelope.

You can make the panning movement dependant on your input signal, so that each time you pause or stop playing the echo signal moves to the other side. If panning both signals, they shift side.

To do this, go to the MODULATION section (- check that the 'PAN' 'window' is <SELECT>'ed). Then press <WAVEFORM> until 'ENV' is chosen. <SPEED> should be set fast enough for the sweep to reach the other side, when you pause in your playing. The pan <DEPTH> should be set at '99' if you want a complete left/right switching.

Note that you can chose quite freely what you want to pan. Setting the delay out volume to '0' will give you a 'dry' Left/Right switching effect.

Your 9th preset sound, Left/Right switching

Adjust the parameters to your taste and then store the sound in preset 9. Press:

<PRESET> <9> <STORE>

3.9.9 An Auto-Panner.

If you want to use the TC 2290 as an 'autopanner' only, you can turn down the volume of the DELAY signal and thus have an automatic panning effect on the direct signal only.

This is simply done by pressing <SELECT> in the OUTPUT section to show the 'DELAY' volume setting and then changing this value to 0 :

Press OUTPUT <DOWN> and then hold it until you reach '0' or press <DOWN> followed by <0> <ENTER> on the numeric keyboard.

The factory preset #92 is an example of a similar 'autopan' setting.

3.10 Tailoring TC 2290 to your own requirements.

Making fading echo tails when bypassing

We go now to some new and interesting aspects of the TC 2290. As an example we will try different bypass-methods as we promised earlier. To do this, first recall our 'old' preset 1 of 400mS delay and a feedback of '25'.

Try to turn off the delay effect while playing. The echo immediately 'stops'. Now, imagine you are playing with a long echo that does **not** stop immediately when bypassing, but finishes 'fading out' the echo repeat.

Now the extravaganza really starts -

The <SPEC> key !

This <SPEC> key is the base for a lot of extraordinary functions on the TC 2290. The hardware itself is capable of a lot more than you see on the frontpanel. We installed this special key to make it possible for you to tailor your TC 2290 to your individual requirements, and to open up future expansion capabilities. We will try an example, personalizing the bypass method.

To get a 'tail' of echo repeats, after bypassing, a special function is used:

<SPEC> ; the DELAY display now shows the last spec.no. and 'S.NO'.
You can now enter the special no. you want to change,
press:
<2><6> ; No. '26' is the special parameter for the Bypass Method.
<ENTER> ; Note that as you pressed <ENTER> the DELAY display
changed to show '2' and, to the right 'S.VAL' to show that
'2' is the current 'special value' of this spec.no.
<0> ; to change the value to '0' for 'input mute' and
<ENTER> ; to end your command.

PRESET 1 is now changed to have 'Mute on input only' when bypassing. Try playing and press <DELAY ON> and OFF and notice that you now get a tail of echo repeats, even after you've pressed OFF.

We will make this the last of your 10 'rehearsal' presets

Your 10th preset sound, 400mS Delay w.tail

Press:

<PRESET> <1> <0> <STORE>

Now this particular Preset 10 has it's bypass method programmed to 'input mute' just like e.g the delaytime of 400mS is stored in this particular PRESET 10.

If you later copy the preset 10, (recall preset 10 and store in another preset number) the bypass method is copied as well.

Of course you can change back by using the <SPEC> key and the correct numbers, whenever you want.

You can find a complete list of Special Number Functions in [9.4], and a

description of the Bypass Methods in [5.1]

The particular setting of Spec.No. 26 value (in this case in PRESET 10) is individual for each PRESET. Other Spec.No.s have influence on **all presets** when changed ('global'), and some even **erase all your presets**, so be careful when using the <SPEC> key !.

- And now let's try a 'making life easier' function:

<ASSIGN> keys

In the previous spec.no example of changing the Bypass Method we used the following sequence of keystrokes:

<SPEC> <2> <6> <ENTER> <0> <ENTER> - a total of 6 keystrokes.

If you want to change the Bypass Method in - say 30 presets, you'll have to make a total of 180 keystrokes (besides the preset shifts).

But that's not needed. The assign <KEY A> or <KEY B> can make life easy for you by doing a 'programmed sequence of key pressings' for you.

To program the assign <KEY A> we use the <SPEC> again, **press:**

Spec.No	Keycode	Comments
<SPEC><4><0><ENTER>	<3><5><ENTER>	; 35 = keycode for <SPEC>
<SPEC><4><1><ENTER>	<2><ENTER>	; 2 = - - key <2>
<SPEC><4><2><ENTER>	<6><ENTER>	; 6 = - - key <6>
<SPEC><4><3><ENTER>	<1><1><ENTER>	; 11 = - - <ENTER>
<SPEC><4><4><ENTER>	<0><ENTER>	; 0 = - - key <0>
<SPEC><4><5><ENTER>	<1><1><ENTER>	; 11 = - - <ENTER>
<SPEC><4><6><ENTER><1><9><9><ENTER>		; 199 = <END OF ASSIGN>

Now the assign <KEY A> is programmed to be a '<set bypass to input mute>' key.

Any time it is touched it does <<SPEC> <2> <6> <ENTER> <1> <ENTER>> for you. This function for assign <KEY A> is 'global' (i.e. independent of current preset#) and continues forever - or until it's re-programmed.

Other examples of 'your own keys'

The above was an example of 'making life easy' by letting an assign key do a sequence for you. Other examples are numerous, the assign keys (two on the front panel and up to 4 as remote switches) can be programmed to do **any** key pressing sequence for you (pressing from 1 to 9 keys for you). You'll find a list of 'keycodes' (one no. for each key to be used when programming the assign keys in [9.5]), and also an example for programming assign <KEY A> to do <PRESET UP> again.

If you now have the impression that the TC 2290 has a lot of controls, we just want to tell you that 'there are more than meets the eye'. You can combine any key sequence to make your own keys. Also there a number of usefull 'image' keys. Keys that are built in your TC 2290, but not physically placed on the frontpanel. The <PRESET UP> and <PRESET DOWN> are

examples of 'imagekeys'.

These keys can all be 'pressed' by programming an assign key to press them [9.5].

Remote assign keys and Panels.

With the remote assign keys you can make a remote switch do **any** key sequence for you (max. 9 key pressings) from a simple remote <DELAY ON> bypass, step one <PRESET UP>, <PRESET DOWN> to making a <<PRESET><1><0><ENTER>> key.

There is a seperate t.c. application note (2290-apn.04) on 'how to make remote switches' if you want to do yourself.

TC 0050 Remote Switch Panel is a '5' switch remote panel with 4 'remote assign keys' and the <LEARN> key.

On the advanced TC 0144 SRC remote control panel the two assign keys <KEY A> and <KEY B> can be pressed along with 12 other switches and displays for a total preset- and external effects in/out switching remote control panel.

The use of this is described in the t.c. application note 2290-apn.02.

3.11 The 10 Presets, you have made

If you followed all the examples your 10 presets will look like this:

PRESET No.	Name	Delay	Feedb.	Modulations		
				Panmod	Dynmod	Dlymod
1	Echo	400	50	.	.	.
2	Dyn Ducked Delay	400	25	.	on	.
3	Dyn Gated Delay	400	25	.	on	.
4	Tremolo	0	0	.	on	.
5	Chorus	25	0	.	.	on
6	Flanger	2	50	.	.	on
7	ADT	80	25	on	on	on
8	Panned delay	400	50	on	.	.
9	Left/Right Switching	400	50	on	.	.
10	Echo w. bypasstail	400	50	.	.	.

Of course these are examples only, change to your needs every parameter you want.

You may have noted that the last preset cipher starts blinking after every <PRESET><number><ENTER> sequence. This indicates the 'SINGLE KEY PRESET SHIFT MODE'. - In this mode only a single numeric key has to be pressed to shift preset within the 'decade' or 'bank'.

Try shifting between 9 of your presets using this 'SINGLE KEY PRESET SHIFT MODE'.

Preset #0 is a special 'autostore' preset, every time you recall a preset the current frontsettings are stored in preset #0. If you forget to store your current settings before you recall another, you can find the 'lost settings' in preset #0.

4.0 INSTALLATION

Before you attempt to use your TC 2290 we recommend that you to read the section 4.1 thoroughly. The guarantee will not cover damages caused by improper installation.

4.1 GENERAL PRECAUTIONS

4.1.1 Mains - Voltage Selector

Before you plug in the supplied main cord please check that the <VOLTAGE SELECTOR> on the rear side has been set to the voltage standard of your country. The according fuze size is printed on the rearpanel and must of course be correct as well.

If you are in doubt about the voltage settings, please check sec. [6.1]

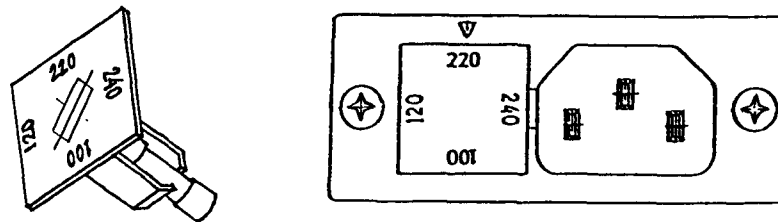

fig.4.1.1 Check that the currently selected voltage as indicated by the small arrow, corresponds to the voltage of your country.

4.1.2 Mechanical Installation

The TC 2290 can 'stand alone' or be mounted on a rack mount chassis or in a flight case. Make sure you only use good quality rackmount assessories. The TC 2290 takes up 2 units (= 88mm or 3.5").

4.1.3 Heat

DO NOT PLACE THE TC 2290 NEXT TO EXTREMELY HEAT-GENERATING DEVICES (such as Power Amplifiers etc.).

The TC 2290 itself also generates some heat, which should be taken into consideration if placed next to a very heat sensitive compressor or the like.

4.1.4 Total Sound Quality is Dependant on more than the TC 2290

Remember that the TC 2290 will only sound as good as the rest of your system allows. If your instrument is noisy or you plug in some inferior effects you cannot benefit from the full S/N ratio of the TC 2290.

Badly shielded cables can affect hum and radio-frequency pick-up.

Your amplifier or mixer system are also part of the 'sound chain' in which the weaker 'elements' decide the total strength of the chain.

Normally guitarists only have problems with noisy effects units although some amplifiers are not exactly quiet.

Keyboard players on the other hand are most often limited by the noise-level of their instrument. Some sort of gating or noisesuppressor device can often do little wonders.

The 'Studio people know mostly how to handle these matters.

4.2 Mono or Stereo Operation

The TC 2290 can be operated in mono as well as stereo.

If you've got 2 separate amp/speaker systems you should try listening to the TC 2290 effects in stereo. Once you've heard it you will never be able to return to mono again.

Wide delay effects and the stereo panning effects possibilities can of course only be obtained with a stereo amplification.

As a compromise it is possible to set up for mono monitoring and stereo on the PA.

4.3 The Jacks and XLR Input/Output Connections

Generally instruments use the high impedance jack input to preserve the harmonics of the instrument and to get the necessary preamplification.

Mixers with studio levels and very high output instruments use the XLR input.

You can get signals for stage monitoring (stage amplifier) from the Jack outputs L/R **as well as** 'linedrive' outputs to the PA/mixer from the XLR outputs L/R, simply by taking signal out simultaneously.

A no-effect buffered instrument output can be taken from the Ext.Effects Send 1 jack. A TC 2290 volume setting dependant, but otherwise unaffected direct output can be taken from the jack and XLR Direct outputs.

Please check sec. [6.3] for XLR cable connections.

4.4 Installation with a Musical Instrument

It is possible to connect the TC 2290 directly to a musical instrument, e.g. a synthesizer or a guitar. Synthesists will welcome the MIDI control whereas guitarists will be pleased with the External Effects and the TC Stage Remote Control possibilities.

4.4.1 Mono Installation

The TC 2290 is normally plugged in between the instrument and the amplifier, as shown in fig.4.4.1

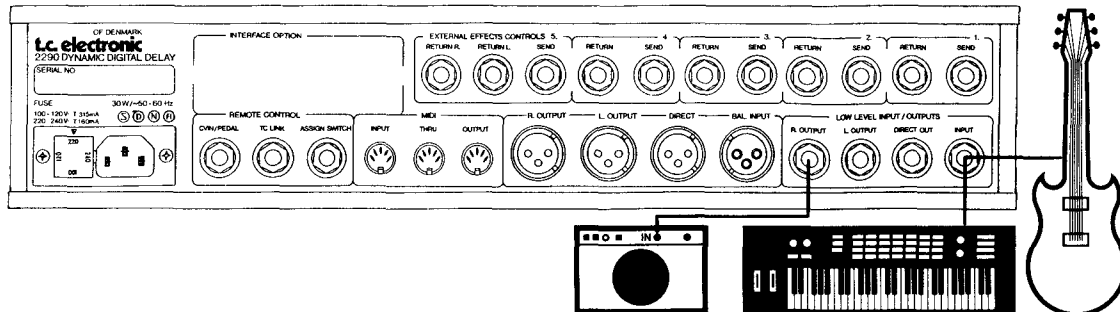

Fig.4.4.1 Mono output installation with a musical instrument.

In mono operation of the TC 2290, any of the L/R jack outputs will do. Just be aware that none of the PAN Section DELAY/DIRECT LEDs are lit, unless you specifically want the signal to be 'panned away' from your output (and appear on the other).

If you have got a normal guitar combo amplifier, pick your normal input. Note that the XLR output can be used simultaneously for a mono or stereo 'linedriver' output to the PA/mixer.

Play the instrument and check that the yellow LED (0 dB) of the PPM meter on the input section only lights momentarily when you're playing and the red (+3dB) LED only lights up on the heavy peaks of your signal.

4.4.2 Stereo Installation

Simply connect the <JACK OUT LEFT> and <JACK OUT RIGHT> of the TC 2290 to the inputs of your amplifiers.

If you are using two different amplifiers, make sure that they have been adjusted to sound identical. Otherwise it will be hard for you to fine tune the stereo effects you are creating on the TC 2290.

Again, carefully adjust the <INPUT GAIN> so that the yellow LED only lights momentarily...

(You could try a set-up home, connecting the Jack L/R outputs to the AUX inputs of your stereo amplifier).

Refer to section [5.1.] for more about INPUT GAIN settings.

4.5 Connecting the TC 2290 to MIDI

If you are a keyboardist and equipped with a MIDI instrument connect the MIDI Out of your instrument to the MIDI IN of the TC 2290. For maximum flexibility you can also connect the TC 2290 MIDI OUT to the MIDI IN of your keyboard. In this way you can use the TC 2290 to control your keyboard patches and vice versa.

Depending on your MIDI setup you may need another MIDI signal flow. The MIDI THRU socket can be used to link yet another instrument (or effect) to the MIDI signals.

See section [8] for more info on MIDI applications.

4.6 Connecting External Effects

If you want to control your external effects just plug them into the external effects loops.

If one of your external effects is stereo you can use ext. effect loop # 5 which has got a stereo return.

To switch in and out an external effect simply press the <CHANGE> key on the front panel of the TC 2290 to make the green LED flash. You can then switch in/out the corresponding effects loops with the <0>-<5> keys on the numeric keyboard. The external effect itself must be 'on'.

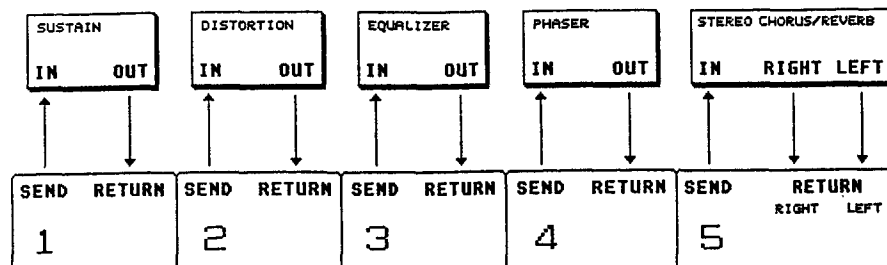

Fig.4.6 Connecting external effects.

The ext. effects connections can also be used as an input selector. To find more about the external effects control please refer to sec.[5.5] as well as to the application notes on the subject [11].

4.7 Installation with a mixer

The input signal to the TC 2290 can be taken from an Aux/Effects Send or an insert point on your mixer.

Adjust the <INPUT GAIN> so that the yellow LED (0dB) only lights momentarily. As <INPUT GAIN> setting is rather critical please refer to section [5.1] if you are in doubt.

The outputs of the TC 2290 may be returned to a stereo Aux/Effects Return.

Another possibility is through two separate channels on the mixer. Remember to set the two return channels pan controls in opposite directions.

4.7.1 Used as an 'Insert' Effect

In this mode the TC 2290 only affects the signals of the channel from which the output to the TC 2290 is taken.

It is possible to return the signal to the same channel but only in mono and thus without the stereo possibilities of the TC 2290. To do a 'insert' stereo return you need yet another channel insert input. Or as mentioned above, use a stereo effects return or 2 separate channels on the mixer.

4.7.2 Used as an 'Aux' Add-on Effect

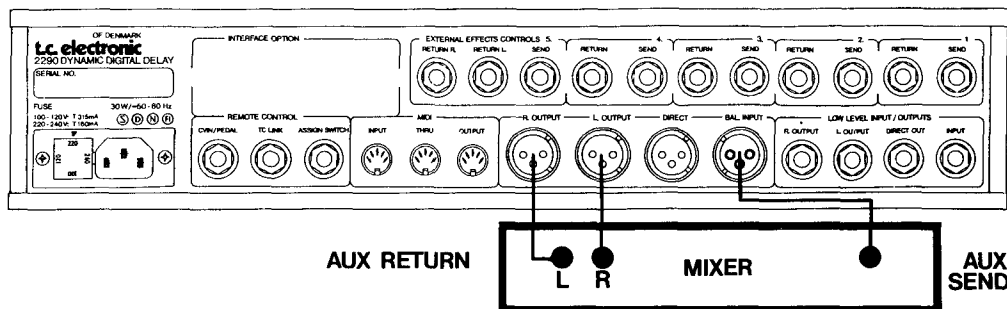

fig.4.7.2 Aux/Effects Send installation with a mixer.

Here the TC 2290 is operated with input from the Aux/Effects Send from the mixer - in this way the TC 2290 can receive input from 'a mix' of channel signals.

It is the Aux/Effects Send control on each of the channels of the mixer that decides what TC 2290 should receive from that channel.

The outputs from TC 2290 are returned to the mixer using either the Aux/Effects Stereo Returns on the Master section or two separate input channels.

In this situation it is generally preferable that the direct signal part of TC 2290 output is muted so that only the effect part of the signal is added to the mastersignal.

Note however, that it may be desirable to use the direct part of the signal for some effects doing e.g. 'tremolo' or 'autopanning' to the direct signal part. Factory preset no.92 (auto panning) is an example of treatment of the direct signal only.

When treating direct signal, you should of course turn down the channel faders of the appropriate channels to avoid having direct signal from two sources.

Please check the Special Number 17 in sec.[9.4] to control the TC 2290 direct signal part independent of presetcontrol.

5.0 THE FRONT PANEL

In the following section you will find a complete survey of all the front panel sections and keys. The description of the control sections is given as they appear on the front panel of the TC 2290 from left to right. For a listing of the commands with each section please refer to sec. [7.0]

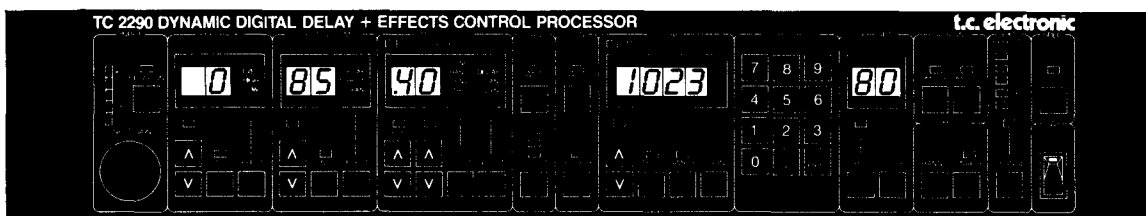

Fig.5.0 TC 2290 Front Panel Layout

5.1 THE INPUT SECTION

The Input section controls the Input Gain Level. The PPM Meter gives you visual response and you can switch the TC 2290 in and out with the <DELAY ON> key. The <INPUT GAIN> must be adjusted so that the Red LED (+3dB) lights only momentarily on extreme peaks in the input program.

(01) PPM METER

(Peak Program Meter). Displays amount of input signal.

As with all audio equipment it is of vital importance that the input level is matched correctly. This will secure the best performance from your TC 2290.

(02) INPUT GAIN.

Control to match Input Gain Level. The <INPUT GAIN> must be adjusted so that the Red LED (+3dB) lights only momentarily on extreme peaks in the input program. The <INPUT GAIN> must be set properly to be able to take full advantage of the dynamic range of the TC 2290. Overload distortion will result if set too high, noise begins to appear if too low. Also all the threshold-oriented effects of DYN and PAN will not work properly if set wrongly. The <INPUT GAIN> features a 20 dB control range. The setting is **not** stored with preset settings.

(03) DELAY ON. (Bypass)

When LED is lit, the TC 2290 will be processing the input signal. With the LED off the input (direct) signal is led to the outputs unprocessed.

By means of Spec. No. 26, you can specify 3 different methods of bypassing, see notes below. (Only EPROM 26.5 and higher).

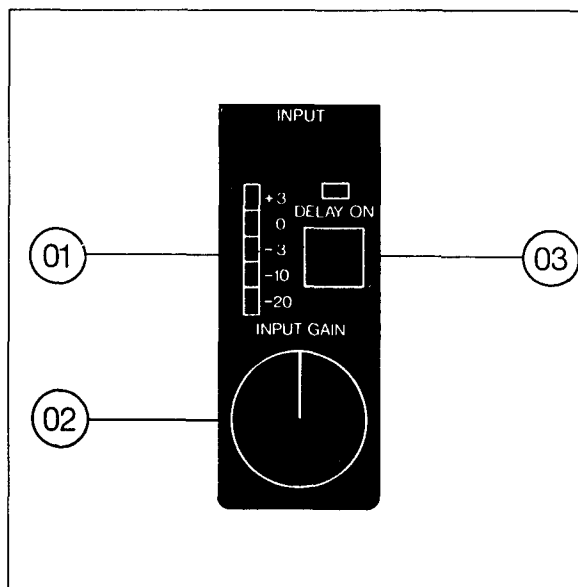

Notes

The bypass function of the <DELAY ON> (as well as any key) is available as a remote control by using one of the <REMOTE 1-5 ASSIGN KEYS>. Check the separate note 2290-apn.04 on the subject.

The status of the <DELAY ON> is normally stored in presets like all other preset parameters. Useful in live performance situations, where you may want to start off with a preset without effect and then manually turn the effect on when needed. Via the special functions you can decide whether the <DELAY ON> switch should be 'in preset' or not [9.4].

The status of the external effects are unaffected by the status of the <DELAY ON> key.

See the notes about direct signal bypass volume in the Output section description [5.3].

[7.1] gives you a survey of commands associated with the Input section and the bypass methods.

The 3 Bypass Methods:

When pressing <DELAY ON> on/off this has the effect:

Special #26 Value	Bypassmethod	Echo tail when bypassing	'History' echo at DELAY ON
'0'	Input mute	Yes	No
'1'	Output mute	No	Yes
'2'	Both mute	No	No (as set from factory)

With Spec 26 set to '0'

Here you get the very useful **input** mute bypass method. With the input mute method, a **tail of echo continues when you turn off the delay**. The delaypath is also 'clean' when you turn on delay. This enables new controlled ways of applying echo, especially when feedback is also applied. Note that with the Input Mute choice (0), the direct signal Volume and the fixed Pan position of the direct signal remains **unchanged** when bypassing.

With Spec 26 set to '1'

If you prefer the traditional **output** mute for a 'history' playback this can be selected by setting spec.no.26 to '1' for 'output' mute only. Suppose that the delaytime e.g. is set at 1000mS, then with the 'output' bypass method the delay immediately starts playing back the echo of what you played one second ago (plus earlier recorded feedback).

With Spec 26 set to '2'

The TC 2290 actually does a double mute when bypassing, - one mute at the input to the delaypath, another at the output. This is unlike traditional delays which mute at the output only. The effect is that the TC2290 delaypath is 'clean' when you turn delay on.

5.2 THE FEEDBACK SECTION

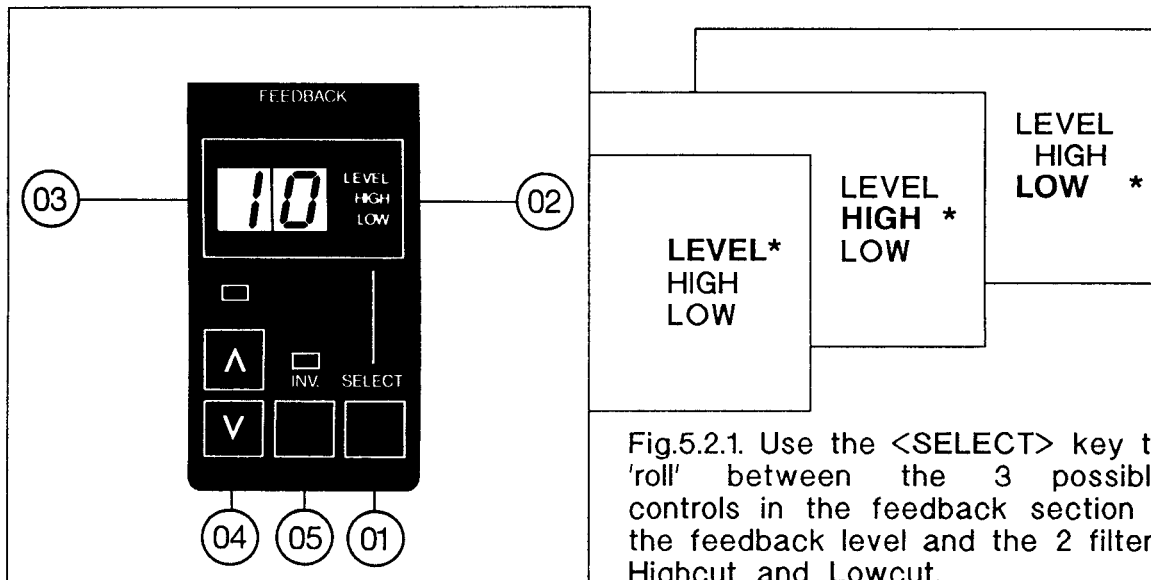

Fig.5.2.1. Use the <SELECT> key to 'roll' between the 3 possible controls in the feedback section - the feedback level and the 2 filters - Highcut and Lowcut.

The Feedback section features a Feedback Level Control and High/Low Cut filters for equalizing the feedback signal.

Feedback determines the number of repeats with echo effects and acts as an intensity Control with chorus/flanger effects.

Feedback is a result of signals output being led back to their own input. Heavy feedback tends to produce unpleasant sounds which you might know about from P.A. systems. Something similar happens if you turn up the Feedback Level on the TC 2290 to it's maximum. A pitched sound is produced with short delay settings. Sometimes this exaggerated feedback effect can be useful in small amounts.

(01) SELECT KEY

Selects parameter to be displayed or changed. 'Rolls' between the 3 possible parameters when pressed.

(02) SELECT DISPLAY

Displays the parameter you have currently selected.

-FEEDBACK LEVEL

-HI CUT FILTER

-LO CUT FILTER

(03) NUMERIC DISPLAY.

Displays values for Feedback Level, HI- and LO CUT FILTERS

(04) UP/DOWN KEYS

Used to enter values for selected parameter. When pressed shortly, value will increase/decrease one step; when pressed continuously value will change continuously. Once touched (green LED flashing), an exact value may be entered on the numeric keyboard, followed by <ENTER>.

While you are entering a new value the display will be flashing, until <ENTER> is pressed.

(05) INVERSE.

When the LED is lit, the feedback signal will be inverted. The chances of hearing if repeat echoes are phaseinverted are very little, but when it is applied to a short delaytime e.g. a flangersound, the different combfilter sound characteristics are pronounced.

Possible values in the numeric display:

Feedback Level 0-99 (% feedback, 0 = no feedback)
HI-Cut Filter 2, 4, 8 and 33 KHz (33KHz = off)
LO-Cut Filter 0, 0.1, 0.2 and 0.4 KHz (0 = off)

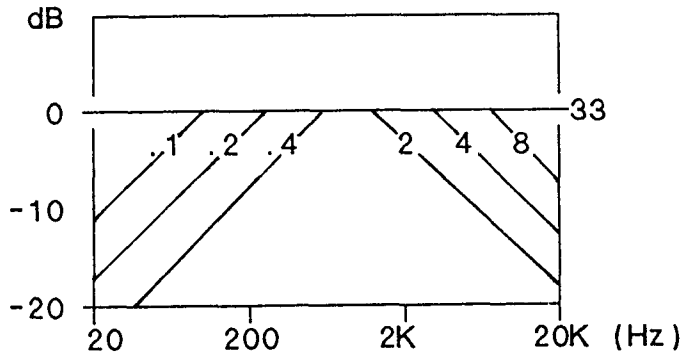

Fig.5.2.2 HI- and LO CUT FILTER frequency responses. With LOW at 0 and HIGH at 33KHz, the feedback filters (for flanger and repeat echo sounds) are 'off'.

With very short delaytimes (0.5-20mS), a low cut at 0.2 or 0.4KHz is good for taking the 'boominess' of a flanger sound away, and a high-cut from 4 or 8 KHz takes away the pronounced 'jet' part of the sound (factory preset #99).

With echo delay settings (>100mS and some feedback), note that the filtering changes the colour of the **repeats** only. The first delay echo as well as the direct signal is totally unaffected by the feedbackfilters.

Check [7.2] for a survey of commands with the Feedback section.

5.3 THE OUTPUT SECTION

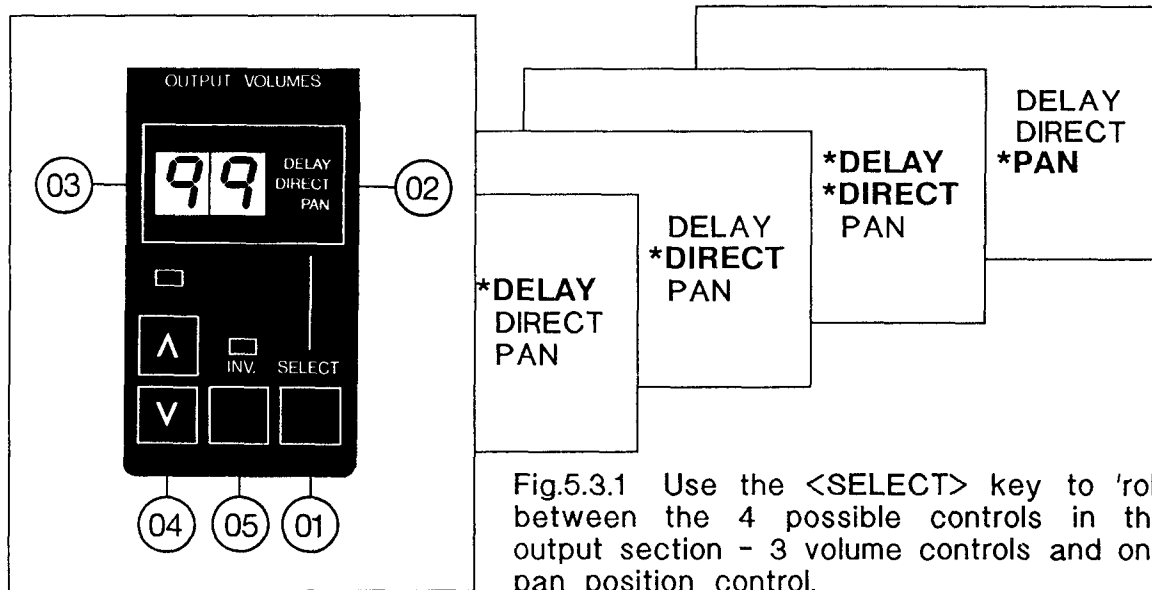

Fig.5.3.1 Use the <SELECT> key to 'roll' between the 4 possible controls in the output section - 3 volume controls and one pan position control.

The Output Section features independent control over direct and delay output volumes as well as a total output volume control (DIRECT and DELAY LED's are lit)

The 4. control is the static pan position of output panning circuitry.

Note that at least one of the LED's <DELAY/DIRECT> in the PAN Section must be lit for **any** pan positioning to have effect.

(01) SELECT KEY

Selects parameter to be displayed or changed> Advances LED display one step when pressed.

(02) SELECT DISPLAY

Displays the parameter currently selected. 4 parameters possible:

- DELAY (delay volume)
- DIRECT (direct volume)
- DELAY+DIRECT (total output volume) and
- PAN (panning position of the direct and delayed signals)

(03) NUMERIC DISPLAY

Displays values for different output volumes and panning.

(04) UP/DOWN KEYS

Used to enter values for selected parameter. When pressed shortly, value will increase/decrease one step; when pressed continuously value will change continuously. Once touched (green LED flashing), an exact value may be entered on the numeric keyboard, followed by <ENTER>.

While you are entering a new value the display will be flashing, until <ENTER> is pressed.

(05) INVERSE

When this key is activated (LED is lit) the output of the delayed signal is phase inverted.

Possible values in the numeric display:

Direct Volume	0-99	(99=max. From 99 to 20 each step is 0.5dB)
Delay Volume	0-99	(99=max. - - - - -)
Total Output Vol.	0-99	(99=max. - - - - -)
Panning Position	0-99	(delay: (0=right 50=center 99=left) (direct: (0=left 50=center 99=right)

Check section [7.3] for a survey of commands available with the output section.

Notes:

The total output volume control is also active when bypassing. In this way it is possible to have as many 'bypass' volumes as you have presets.

If you want the total output volume to be unaffected by the preset switching, to become a 'manual output volume control', set spec. #16 to '1'.

The direct signal volume is when bypassing affected by two parameters :
The spec. #25, setting 'direct signal bypass volume' and the above mentioned total output volume control.

For use with mixing consoles, you can specify that the direct signal volume setting is independent of preset control, volume is then 'manually' set by the frontpanel parameter only and can be turned down when needed. (Spec. #17 set to '1').

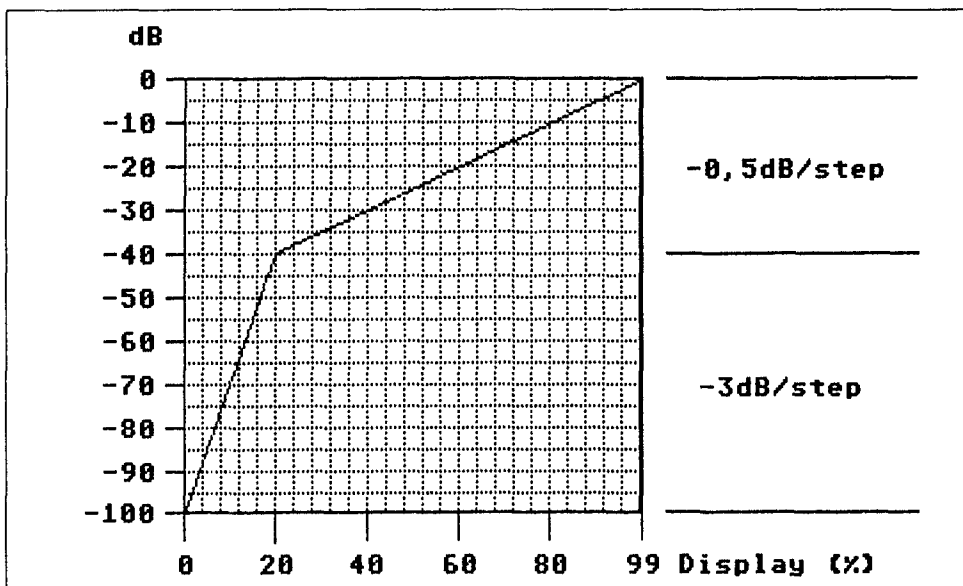
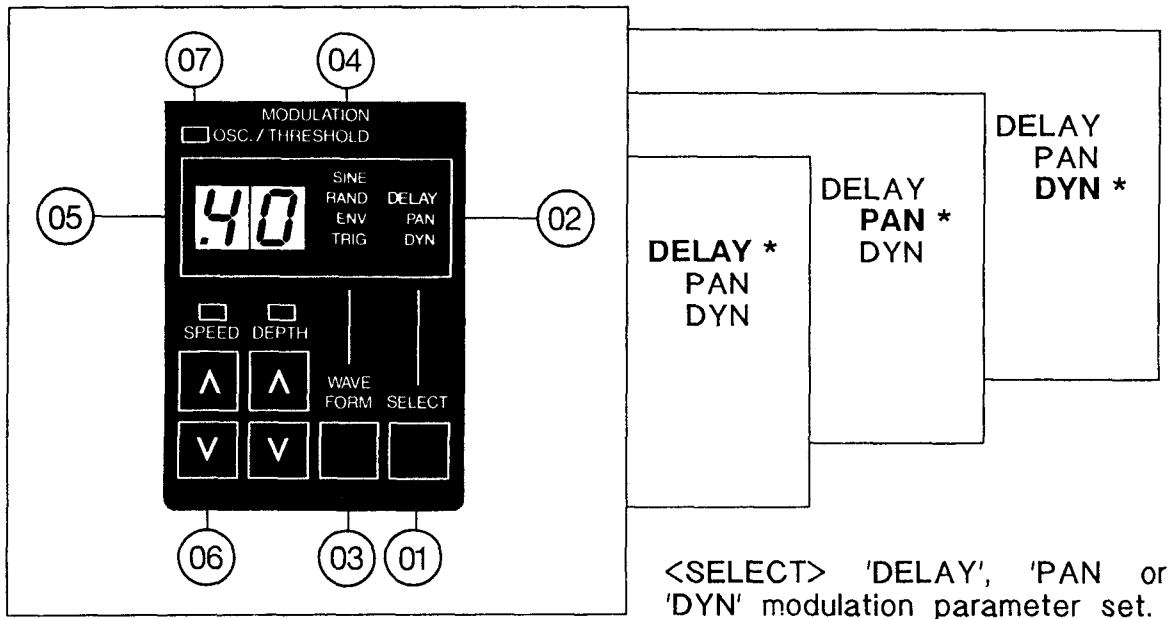

Fig 5.3.2 All the volume controls are calibrated after an 'audio-taper' function with each step being -0.5 dB from '99' down to '20'.

5.4 THE MODULATION SECTION



The TC 2290 features 3 different kinds of modulation effects:

- | | |
|--|--|
| 1. Delaytime modulations | for chorus, flanger, pitchmodulation and ADT effects |
| 2. Panposition modulations | for 'autopanning' of the direct -, the delay signal or both. |
| 3. Dynamic (volume) modulations | for tremolo, compress-, expand-, duck- and gating effects. |

The modulations of the delaytime, the panposition and the dynamics is controlled by **3 sets** of modulation parameters. 'Roll' between the parameter sets by pressing <SELECT>. The 3 parameter sets are completely independent. They just share the MODULATION section to set their very similar, but individual modulation parameters.

Each parameter set consists of SPEED, DEPTH and WAVEFORM values.

To enable modulation there is a <MOD> on/off key in each of the sections DELAY, PAN and DYN. This makes the in/out switching of the modulations effects very easy.

Note that no delaytime, panning or dynamic modulation takes place unless the corresponding DELAY, PAN, DYN section <MOD> key is on.

(01) <SELECT> KEY

Use this key to select one of the 3 different modulation parameter sets (DELAY/PAN/DYN). Each time the key is pressed the SELECT LED display will advance one step and the DELAY, PAN or DYN values appear in the waveform and the speed/depth display.

(02) <SELECT> DISPLAY.

Indicates which of the 3 modulation parameter sets is currently selected.

Select between :

'DELAY'	Delay time	modulation parameter set)
'PAN'	Pan position	- - -)
'DYN'	Dynamic (volumes)	- - -)

(03) WAVEFORM KEY

With this key you can choose between the 4 different modulation waveforms. The waveform LED display advances one step each time you press the key. Choosing a new waveform may require a new setting of SPEED and DEPTH parameters.

(04) WAVEFORM LED DISPLAY

Indicates the waveform associated with the selected modulation destination.

The <WAVEFORM> key moves through 4 possible values:

SINE	for sine wave modulation
RAND	for random wave modulation
ENV	for a input signal envelope controlled form of modulation
TRIG	for a input level triggered form of modulation

(05) SPEED/DEPTH NUMERIC DISPLAY.

The SPEED/DEPTH display shows the value of either SPEED or DEPTH, according to which <UP/DOWN> was last pressed. The green LED above the <UP/DOWN> keys shows whether it is SPEED or DEPTH.

The speed of a modulation (LFO rate or attack/release) is always controlled by the SPEED parameter. The depth of a modulation is controlled by the DEPTH parameter.

Calibrations:

The Depth value is shown in % of max modulation. A DEPTH value of '0' means no effect.

The SPEED value is shown in Hz (cycles per second). A 'cycle/time' with the envelope and trig functions is from no effect to max. effect, so a setting of '1' means that it takes one second, while a setting of '5' means that the time from no effect to maximum effect is only 1/5 of a second.

Possible values in the numeric display:

MODULATION SPEED/RATE	.10-10 Hz	(equals 10 to 1/10 second)
MODULATION DEPTH	0-99 %	(99 = max)

(06) <UP/DOWN> KEYS

The two pairs of <UP/DOWN> keys are for modulation SPEED and modulation DEPTH.

By pressing either of the pairs (SPEED/DEPTH) the current value for SPEED or DEPTH appears in the modulation parameter display and the green LED above SPEED or DEPTH lights up.

Both pairs work the same way, i.e. pressing the keys once only will cause the green access LED to flash, pressing twice will increase/decrease one step; and holding the key will increase/decrease the value continuously.

Once you have touched any of the <UP/DOWN> keys (green LED flashing), an exact value may be entered on the numeric keyboard, followed by <ENTER>. While you are entering a new value the display flashes, until <ENTER> is pressed.

Note that with ENV/TRIG waveforms, the SPEED keys control the 'speed of the volume change'.

(07) OSC./THRESHOLD LED.

This yellow LED shows modulation speed when using periodic modulations (SINE, RANDOM) and shows when the input level passes threshold for envelope or triggered effect. The threshold levels can be changed in 9 steps via the special functions. (Spec. #10-#13)

Please refer to the modulation charts in section [9.2] for a listing of all the modulation possibilities.

5.5 THE PAN SECTION

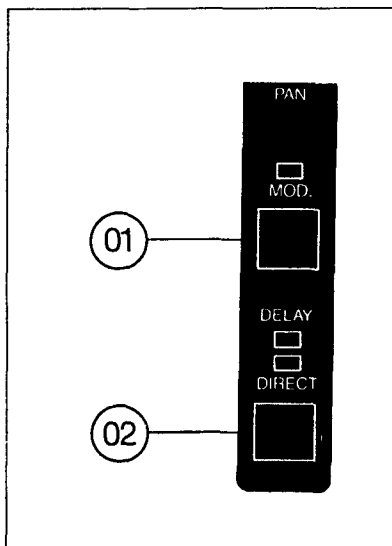

The PAN section controls the way in which the pan modulation signals are applied to the panning of direct and delay outputs. The panning section also determines if panning should take place and what should be panned. When panning is used in conjunction with chorus/flanger effects extraordinary broad stereo images can be created. Panning can be both fixed (using the OUTPUT SECTION) and automatically controlled (using the modulation Section).

When both fixed and automatic panning are used simultaneously, the fixed panning position sets the starting point for the panning movement.

Note that NO panning whatsoever will take place unless at least one of the LED's ('DELAY' or 'DIRECT') are lit.

(01) <PAN MOD>

When this key is activated (LED is lit) the pan-position of output signals can be modulated. The way the pan-position is modulated is set by the parameters of the 'PAN window' of the MODULATION section.

At least one of the <DIRECT/DELAY> LED's must be lit for **any** panning to take place.

(02) <DELAY-DIRECT>

By means of the <DELAY-DIRECT> switch you can select one of 4 panning possibilities, i.e whether you want to apply panning to the DELAY signal, the DIRECT signal, BOTH or neither of the signals.

1. DELAY LED lit:

Pan-position of the DELAY signal will now be as set in the OUTPUT SECTION. With <PAN MOD> on, this position is modulated according to the values set for the PAN MODULATION. The DIRECT part remains fixed in center.

2. DIRECT LED lit:

Pan-position of the DIRECT signal will now be as set in the OUTPUT SECTION. With <PAN MOD> on, this position is modulated according to the values set for the PAN MODULATION. The DELAY part remains fixed in center.

3. BOTH DELAY and DIRECT LED's are lit:

Pan-position of both signals is set in the OUTPUT SECTION.

With <PAN MOD> on, this position is modulated according to the values set for the PAN MODULATION. The two signals are now panned in opposite directions, so when DELAY signal is in LEFT, then the DIRECT part of the signal is in RIGHT and vice versa.

4. With NONE of the DELAY-DIRECT LED's lit no panning whatsoever takes place. In this instance the DELAY part of the output signal appears with equal strength, but phase reversed to both LEFT and RIGHT outputs. The phasereversing enables you to produce a broad diffuse sound field of the DELAY effect, which especially is nice with chorus/flanger effects.

The DIRECT part of the signal remains fixed in center. Please note that in this position the total stereo output image is pleasantly broad, but is not monocompatible.

5. Echo in phase to left and right channels.

As mentioned above the left and right delay outputs are phase reversed when »DELAY« or »DIRECT« in the PAN section are not activated. To obtain echo in phase press:

<PRESET> <8> <0> <ENTER>. This is the phase reserved echo. Then activate »DELAY« and »DIRECT« LEDs in PAN section. Press <SELECT> in OUTPUT section until the PAN LED is lit. To get the direct signal and the echo in equal levels in both channels press <DOWN> <5> <0> <ENTER>. To get same level as in preset 80 press in the OUTPUT section <SELECT> until »DELAY« and »DIRECT« LEDs are lit, and <9> <0> <ENTER>.

When enabling panning modulation please observe that you will get continuous panning movement with the SINE and RANDOM waveforms, while the ENV and the TRIG panning waveforms are dependent on the input signal.

Please refer to the modulation chart [9.2] to find out the pan-position modulation possibilities and/or check [7.5] for a summary of commands with the panning section.

5.6 THE DYN SECTION

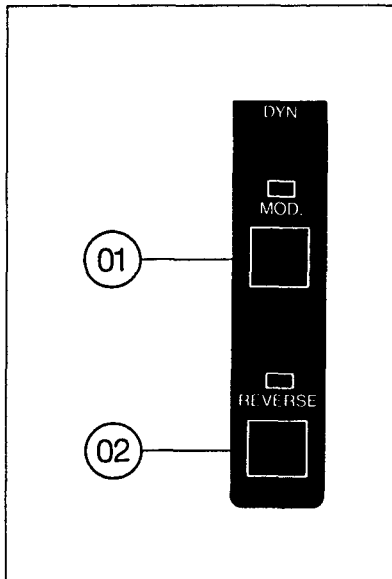

Fig. 5.6.1 Use the <MOD> key to switch on/off Dynamic modulation.

The DYN modulation facilities give some exciting effects possibilities.

By controlling the direct-, the delay- and the feedback levels in various combinations, effects like tremolo, delay-compressing, ducking, expanding and gating are possible.

By 'ducking' the echo and feedback levels, echo effect is lowered while you are playing, but return when you pause slightly. In this way you can 'clear up' an otherwise 'muddy' echo effect to get better echo effects.

You can set the delayed output to stay at a fixed level even if the input signal varies strongly in amplitude (compression effects), or the other way round by <REVERSE>'ing the function (expansion).

The speed and depth of all the dynamic modulations are set in the MODULATION section. The threshold levels of the input level controlled effects can be changed using spec.no.

(01) <MOD>, Dyn Modulation Key.

This key toggles all dynamic modulations on/off. The <MOD> key LED lit indicates that dynamic effects take place. Thus with the <MOD> key an easy way of applying and checking the effects of the DYN modulation is possible.

(02) <REVERSE>, Dyn Reverse Key

When LED is lit, all functions of the DYN section will be reversed in some manner.

Thus the tremolo effect which is available with the SINE and the RANDOM waveform converts from the common volume modulation to a modulation which enhances delay volume, when direct volume is suppressed and vica versa. (E.g. for creating more realistic Double Track Effects).

The modulations available with ENV and TRIG converts with <REVERSE> on from Compression/Ducking to Expansion/Gating to produce effects like 'Gated Echo'. (Gated feedback echo is useful enhancing echo on e.g. a drum sound, otherwise impossible without a long tail of disturbing echoes).

The modulation chart in section [9.2] gives a survey of the dynamic modulation effects and parameters.

5.7 DELAY SECTION

The Delay section contains controls for setting the delay time via the <UP/DOWN> keys or through the <LEARN> key. The <MOD> key enables/ disables delaytime modulations. The <SAMPLE> key enables sampling (hold/repeat without sample option PROM) The 4 cipher display normally shows delay time but is also monitor for entering special numbers and values as well as for showing error messages.

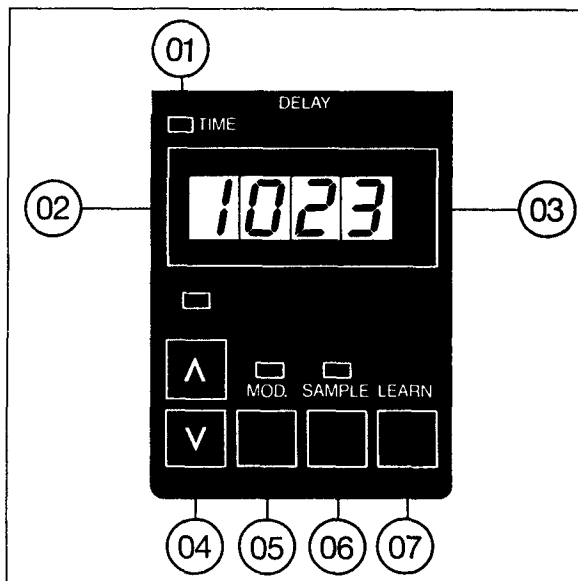

(01) DELAY TIME LED

Shows the 'rhythm' (repeat time) of the echo. The LED flashes at an interval equal to the set delaytime, thus indicating the time distance between individual repeats in the echo signal. Monitoring this LED you can quickly see if the delaytime matches the music. Delaytime must be larger than 100 mS to enable the delay time LED to flash.

(02) DELAY TIME DISPLAY

This 4 cipher display normally shows delay time in mS (1/1000 sec.). Note that delay times less than 100mS can be entered with a 1/10 of a mS resolution using the numeric keyboard <> key (e.g. 11.2 mS). If your 2290 is installed with more than 10 seconds delay memory, greater delaytimes than 9999 mS are shown in seconds instead (e.g. 23.11 sec). The delay display doubles to monitor special numbers and values as well as for showing error messages. This is shown by the:

(03) FUNCTION DISPLAY

If one of the function display text LED's are lit, the DELAY TIME display is functioning as monitor for either:

TEXT	DISPLAY MONITORS
none	Delaytime
'ERR'	Error Number, check the error no. list. in appendix
'S.NO'	Special Number, check section <4.13> for more about special number and value applications.
	Press <><> to cancel spec.no. access.
'S.VAL'	Special Value

Possible values with the delay time display:

DELAY TIME standard, 0.1 mS to 1023mS
 with options, 1024mS through 9999mS to max. 32.76
 seconds

SPECIAL NUMBER 0-99

SPECIAL VALUE depends on special no.

ERROR MESSAGES see troubleshooting sec. [10] for error # indications.

(04) <UP/DOWN> KEYS

for increasing/decreasing delaytime. The first press of one of the keys will cause the green access LED to flash, a further short press increases/decreases delaytime one step and holding the <UP> or <DOWN> key will cause the delaytime to be increased/decreased continuously.

With one of the sampling options fitted the <UP/DOWN> keys help in setting the 'front' and 'rear' points of the wanted sample extractions.

(05) <MOD> Delay time modulation enable key

No modulation of the delaytime whatsoever will take place unless <MOD> is activated (LED is lit).

With one of the sampling options fitted the <MOD> key enables pitchshift of sample.

(07) <LEARN> ('tempo tab') key

With this key you can set the delaytime to match the music in an easy manner. Pressing <LEARN> once causes a counting function, which counts the time elapsed until <LEARN> is pressed again. If the time between the two taps is within the available max. delaytime this time will be the new delaytime.

The <LEARN> delaytime tapping may be performed at any time, however with some feedback and/or modulation settings you might want to adjust some of these parameters according to the new delaytime setting.

The <LEARN> function is available as a remote switch as well. Just connect a simple footswitch to the SWITCH TYPE remote JACK socket.

With one of the sampling options fitted the <LEARN> key doubles to manually trig start/stop record sample sounds and trigs/re-trigs playback of selected sample.

(08) <SAMPLE>

Without the sample option PROM, this is a simple HOLD/REPEAT function. Pressing <SAMPLE> enables a continuous repeat of the last 1023 mSec of playing until <SAMPLE> is pressed again. (With memory option the 1023mSec is variable with spec.no. 38.)

See sec [8.2] for the sample option possibilities.

5.9 THE PRESET SECTION

This section handles all preset store and recall operations. The 100 presets (00-99) are organized in 10 banks (0-9) each consisting of 10 presets (0-9). The factory presets are located in preset numbers '80' through '99' and are by default made 'protected', read only presets. All presets below 80 are from the factory set equal to preset '80' and are not 'protected'. Copy, alter and organize to your needs the factory presets to the lower numbers of presets. Check sec. [9.1] for a list of the factory presets.

The preset '00' is a special autostore preset, which stores the current front-settings each time another preset is recalled.

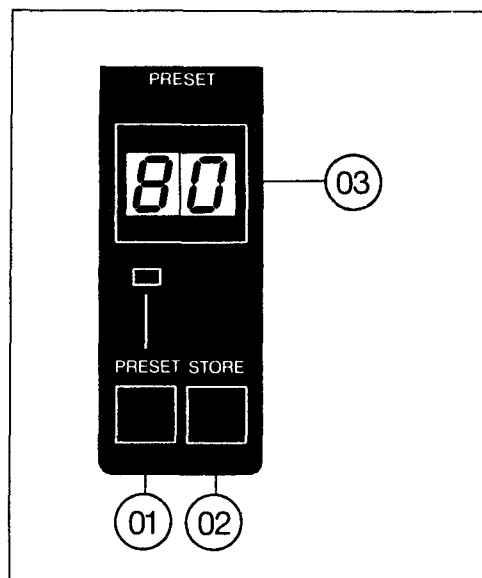

(01) <PRESET> KEY

Pressing <PRESET> enables a preset to be recalled. The first <PRESET> key press enables numeric keyboard access (green LED flashes), the preset number wanted may then be entered on the numeric keyboard and terminated by <ENTER>.

Thus the sequence to recall a preset is <PRESET><number><ENTER>. The number must be between 0 and 99. Omitting the <number> re-recalls the current preset number.

Just after a preset recall sequence, the last cipher in the PRESET DISPLAY starts flashing, indicating 'SINGLE KEY PRESET MODE'.

In SINGLE KEY PRESET MODE any numeric keypress <0-9> recalls preset (0-9) within the 'decade-bank'.

To shift to another decade-bank of presets you must use the full preset recall sequence.

Once you edit a preset using any of the keys below a green LED, SINGLE KEY PRESET MODE is terminated.

Presets shifts can also be remote-controlled from MIDI, from the TC SERIAL REMOTE CONTROLLER (see descriptions in 'OPTIONS' section [8.3]) or single step up/down advanced from a simple footswitch array (see application note 2290-apn.04 section [11])

For more commands examples regarding preset operations check section [7.0].

(02) <STORE> KEY

The <STORE> key is used to store the frontsettings in a preset:

<PRESET><number><STORE>

With no number given, frontsettings are stored into current preset no.

A non-succesful store will result in the display of either

error no. 3 : preset is protected, you cannot store in this preset no.
 (presets 80-99 are from factory set write-protected,
 but you can change this if you want, see 'special'

error no. 4 : section [9.4] on how to protect presets.)
incorrect key sequence before <STORE>

Note that pressing <STORE> key alone has no effect (except the display of error no. 4). It is simply to avoid 'updating' your presets accidentally !

EXAMPLES:

<PRESET><2><STORE> ; stores front settings into preset 2
; (and jumps to preset 2)

<PRESET><STORE> ; updates current preset no. with changed
; frontsettings.

<PRESET><STORE> ; updates current preset no. with changed
<ENTER> ; frontsettings and enters SINGLE KEY
; PRESET SHIFT MODE

(03) PRESET DISPLAY

The PRESET DISPLAY shows currently selected preset number. Left cipher is referred to as the 'bank' no., right cipher as the preset number within the bank.

Following a <PRESET> <number> <ENTER> sequence, the last preset display cipher starts blinking (indicating SINGLE KEY PRESET SHIFT MODE) which means you may continue selecting presets within the current preset bank by pressing any of the numeric keys.

The SINGLE KEY PRESET MODE is cancelled by the use of any of the keys below a green LED or by pressing <.>

Recalling current preset number by the <PRESET><ENTER> sequence also enters SINGLE KEY PRESET MODE.

Note:

All presets above '79' (the factory presets) are 'protected' as default by the factory. This can be changed (see SPECIAL section, spec.no 8) so that you can have your own presets here as well.

By means of a special no you can always get back the factory presets. (See section [9.4], spec.no 37).

5.10 THE ASSIGN SECTION

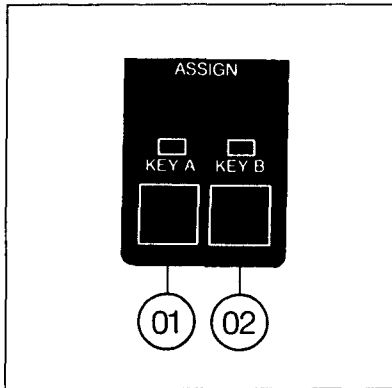

The assign keys <KEY A> and <KEY B> are two user programmable keys, which may be set to perform any keystroke sequence of up to 10 steps each, by pressing only a single key.

Assigning functions to the assign keys is done via special functions.

In other words, you have got two keys 'of your own', with which you can carry out any function that the TC 2290 is capable of producing. You can set the assign keys to do special number setting or to select another bank-preset or to make a setting more easy.

Typically application of the assign keys is for performing functions which normally are only accessible via special functions, and therefore too hard to reach in a performance situation. But any keystrokes can be programmed for instant access.

Each key on the TC 2290 has a specific number and it is these keynumbers that you write in a sequence to be performed by e.g. <KEY A>. When <KEY A> is pressed it is as if you are entering the keystroke sequence yourself.

The sequence for Assign <KEY A> is written into the Special Function numbers 40-49 and the sequence for Assign <KEY B> into the numbers 60-69. If the sequence of keynumbers is smaller than 10, the <END OF ASSIGN> value '199' must terminate the sequence to tell TC 2290 that the end of the sequence has been reached.

Please find a list of key numbers to be used with the Assign Keys in the Appendix section [9.5]. Also some examples of programming the assign keys can be found in section [3.10].

5.11 THE MIDI SECTION

For those of you who don't know or would like to be reminded of what MIDI is, please check the application note tc-apn.06 'WHAT IS MIDI'. The MIDI Section provides you with instant access to the most important MIDI parameters - MIDI Enable and selection of MIDI Channel.

(01) <CHANNEL>

Key for selecting the MIDI (transmit/receive) channel. When <CHANNEL> is activated the current MIDI channel number appears in the Delay Time Display.

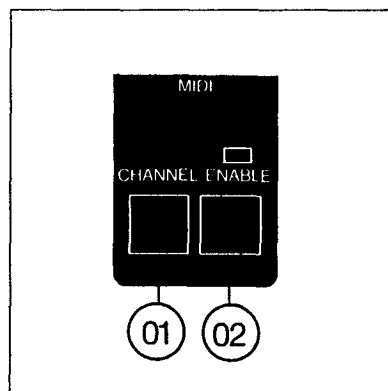

Use the numeric keyboard to enter the MIDI channel number from 1 through 16, entered number must be terminated with <ENTER>.

Thus the sequence to change MIDI Channel is <CHANNEL> <number> <ENTER>. Omitting <number> means channel number remains unchanged.

If TC 2290 is in MIDI mode Omni On, the selected channel number will only

have effect on the transmit channel, as the TC 2290 in this mode receives on all channels.

The MIDI receive mode is set using SPEC.NO.5 which you can set to '0' for Omni On (receive on all channels), '1' for Omni Off (receive on selected channel only).

(02) <ENABLE>

When the LED is lit, the TC 2290 responds to MIDI input messages. MIDI inputs to the MIDI INPUT socket (on rear side) but always passes on to the MIDI THRU socket (so you can have a MIDI chain of connections functioning un-interrupted).

MORE ABOUT MIDI

Please refer to the separate MIDI section <8.1> for more about MIDI with the TC 2290.

5.12 THE EXTERNAL EFFECTS SECTION

With this section you are able to control the on/off switching of up to 5 external effects with the TC 2290. On the rear panel you will find 5 sets of SEND/RETURN jack connections. These sets are the 'effect loop' connections. The return no.5 is a stereo RETURN set.

With the TC 2290 you can select which of the five effects connected to the loop connections should be part of the sound.

Each of the 100 presets can then store the combination of effects you want, providing you with a complete effects system with up to 100 preset sound combinations of DELAY, VOLUME etc. settings and SUSTAIN, DISTORTION, PHASER, EQUALIZER and STEREO CHORUS and so on.

Every simple preset recall will then effect a new sound setup.

For on-stage use the preset sound selection can be controlled from e.g. a footpanel or via MIDI.

The EXTERNAL EFFECTS feature can be used to select up to 5 different instruments by using the RETURN inputs only. Combinations like 2 instruments, 4 external effects are also possible.

If your combo amplifier has a remote effect on/off connection this can be controlled as well.

In the studio this INPUT selection feature will typically be used to select between different sources (channels) and/or to control 5 rackmount effects which has a provision for external remote control.

(01) <CHANGE>

Pressing the <CHANGE> key enables numeric keyboard access (green LED flashing) to control the external effects. With the green LED flashing, pressing a number from <1> to <5> will switch in or out the external effect of this number.

Pressing <0> will switch in/out the **total** combination of the external effects.

<.> cancels ext. effects access.

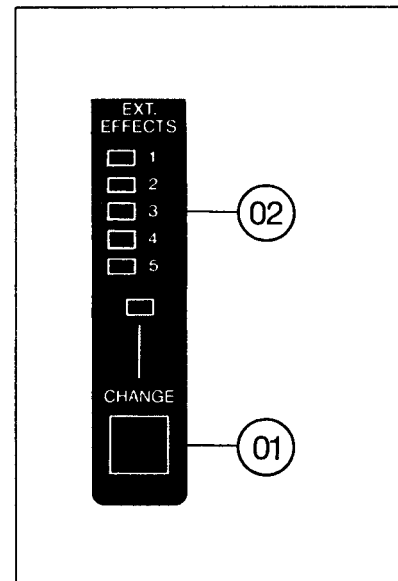

Note that when looping in/out external effects with the TC 2290, the external effects themselves must always be **on**. It is then up to the TC 2290 to choose whether the signal must be taken from the output of the external effect (loop on) or the effect is simply to be ignored (loop off). So when the LED corresponding to the external effect is off, the signal does not pass the external effect (although it is still sent to the external effect. In this way the quality of the signal with the external loop off is not dependent on the sound quality of the external effect).

(02) EXT.EFFECTS LED DISPLAY

Indicates which effects (loops) are currently activated.

The effect loop control is by default stored with all other TC 2290 settings in preset so that you can make total sound combinations. If you wish however, they can be removed from preset control (with SPEC.NO. 18 set to '1').

MORE ABOUT EXTERNAL EFFECTS

A separate application note (section [11]) and the rear panel connections section [6.5] gives you more tips and hints about external effects control, and how to connect external effects and/or instruments.

5.13 THE SPECIAL SECTION

This single key contains a lot of extra TC 2290 parameters. The hardware itself is capable of controlling a lot more than is possible with the individual keys on the front. So we installed this <SPECIAL> key to make it possible for you to 'tailor' the TC 2290 to your individual requirements, and open for future expansion capabilities.

With the <SPECIAL> key you can program completely different things such as Preset Protect, Threshold Levels, monitor the last error message, program the <ASSIGN KEYS> and so on.

Most of the Special parameters are global, i.e. they affect all presets and cannot be stored individually with single presets.

Each special number is a parameter with an associated special VALUE. Some special numbers have continuously variable values e.g. from '0' to '99', other special numbers simply act as 'switches' and can only have the values '0' or '1' (off/on).

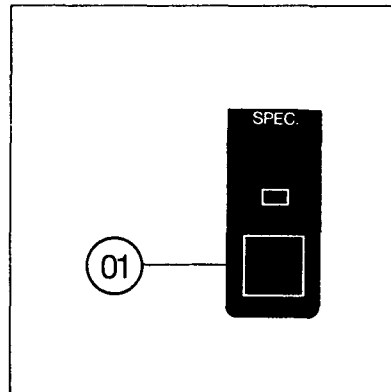

(01) <SPECIAL>

By pressing the <SPECIAL> key a number will appear in the Delay Time Display and the 'S.NO.' LED is lit. This is the number of the last accessed special function.

If you press the <SPECIAL> key the last special number used will appear in the DELAY TIME display. Observe that the little display to the right of the DELAY TIME display reads 'S.NO.', indicating that the display now shows a special number. A new special number can now be entered on the numeric keyboard terminated by <ENTER>. Once you press <ENTER> the value for the selected function appears in the DELAY TIME display ('S.VAL.' appears in the little display).

You may now change this value using the numeric keyboard to another value of your choice terminated by <ENTER>. Please find a survey of the different special numbers and their functions in the appendix section [9.4].

TEXT	DISPLAY MONITORS
'S.NO'	Special number. You can now press <ENTER> to give access to the value associated with this special no. Or you can enter another valid spec. no. on the numeric keyboard followed by <ENTER>
'S.VAL'	Special Value With the 'S.VAL' LED lit the value of the selected spec.no. can be monitored or changed. Enter a new, valid, number on the numeric keyboard and terminate with <ENTER>. Pressing <> cancels spec.no. access with no changes.

5.14 Power On/Off

Turning power on/off. When turning on power the TC 2290 recalls the last accessed preset #. In this way an accidental failure in the mains power supply will not disturb your current sound setting. Not stored frontpanel settings, however, will be lost.

6.0 THE REAR PANEL

6.1 THE MAINS SECTION

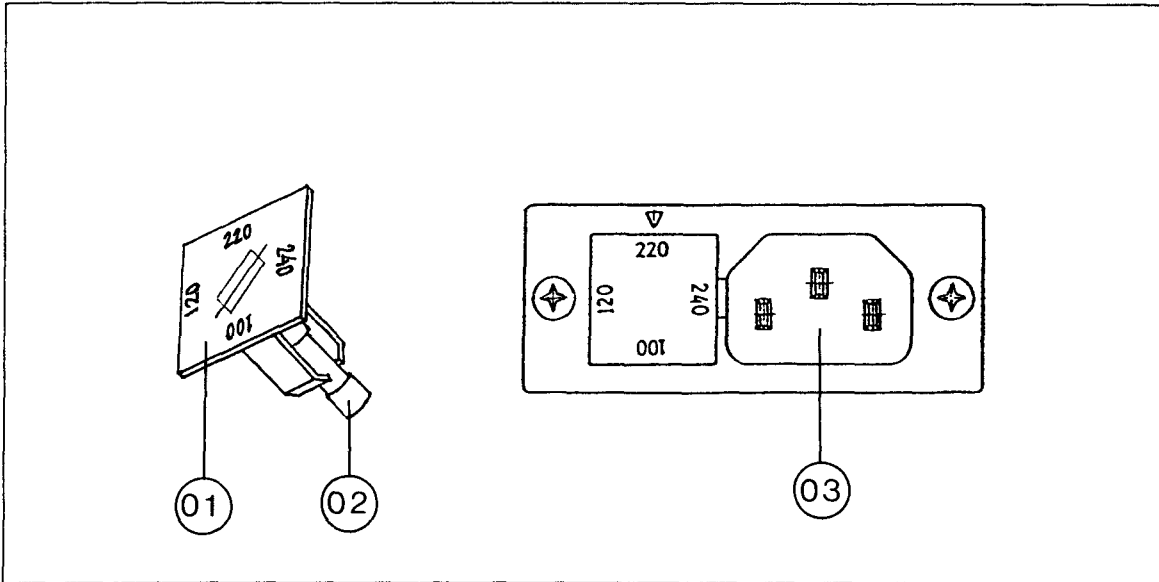

(01) Voltage Selector/Fuse Holder

To change the voltage or access the fuse use a screwdriver to lift up the fuse holder/ voltage selector part.

The 4 available voltages (100-120-220-240 V) are marked into the fuseholder and the currently selected voltage is indicated by a small arrow. If changing voltage setting the fuse size must be correct as well.

Fuse values for the 100-120 or 220-240V ranges respectively are indicated on the rear panel.

Normally 110 V users should use the setting indicated by '120'. This setting covers from 103 to 127 V **absolute limits** of the mains voltage.

However at heavily loaded locations the 100 V might be more appropriate. This setting covers from 94V to 116V as the **absolute limits**.

The other voltage settings cover +/- 10 % limits of the selected voltage.

(02) Main Fuse

If shifting fuse **take care** that the fuseholder part is orientated correctly before slipping it back so that you do not accidentally change the voltage. Fuse values for the 100-120 or 220-240V ranges respectively are indicated on the rear panel.

(03) Mains Connection

Connect the TC 2290 to mains power with the mains cord that comes with the TC 2290. The wiring is according to the IEC standard with the mid pin of the mains connector socket connected to the chassis of the TC 2290. - So be very careful if you ever have to use an 'unauthorized' cord.

6.2 JACK IN- AND OUTPUTS SECTION

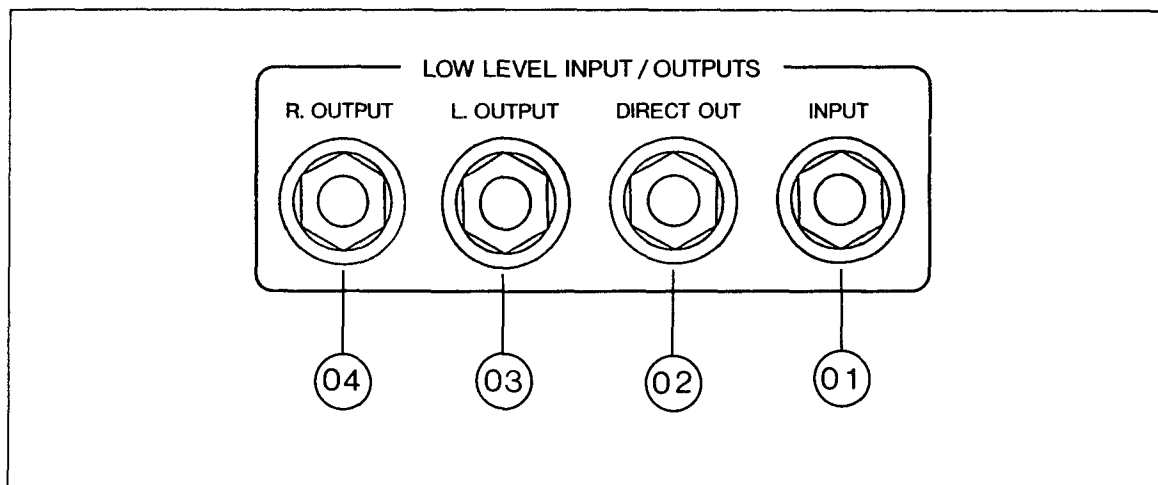

The TC 2290 has two sets of in- and outputs which carry equal signals, but at different levels. The JACK INPUT/ OUTPUTS are made for low level in/ out connections.

The JACK INPUT is, because of its high input impedance, excellent for direct connection to a musical instrument. The high input impedance makes it able to pick up all harmonics and high frequencies.

The processed signal appears in stereo at the JACK LEFT/RIGHT OUTPUTS. Depending on the direct signal part parameter settings, the direct signal may or may not appear in these jacks.

(01) JACK INPUT

Feed the signal to be processed in through this socket.

Check the Tech. Specs for min/max input sensitivity.

(02) JACK DIRECT OUTPUT

Output of direct (unprocessed) signal. May be used to feed another effects unit in a chain. Note that this output is affected by the DIRECT and TOTAL Volume Settings as well as by the TC 2290 effects, processing the direct signal part.

If you want an output which is 'a buffered copy' of the input signal, use the ext. effects SEND 1 output.

(03) JACK LEFT OUTPUT

Normal instrument level output of processed signal. Use this output if mono operation. The low output impedance will allow long cables to be connected with no degrading of the signal quality. For stereo effects you have to connect RIGHT output also.

(04) JACK RIGHT OUTPUT

Right output of processed signal. For stereo effects you have to connect LEFT output also.

6.3 XLR IN- AND OUTPUTS SECTION

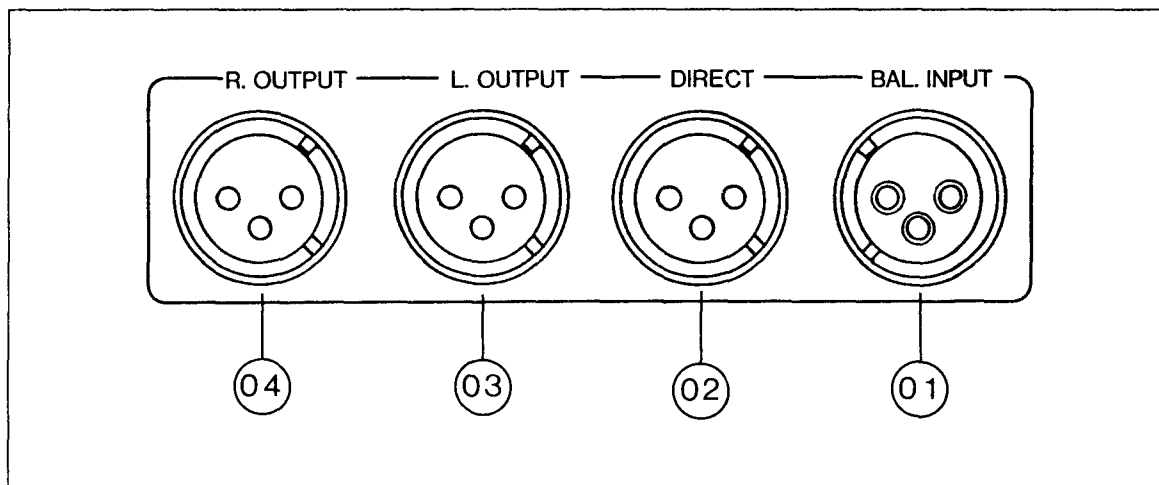

The XLR In- and Outputs connections are high level, balanced input/ output connections.

Most studio- and a number of stage mixer installations will use the XLR connections to benefit from the balancing and the better drive capabilities of the XLR connections.

Please check the tech.specs for in/out levels and impedances.

(01) XLR BALANCED INPUT

Feed the signal to be processed in through this socket.

Due to a lower input impedance and the higher input level capabilities, it is not a good idea to an instrument input here. This Input is made for studio levels and sourcing. If feeding from an unbalanced source, pin 3 should be grounded.

(02) XLR BALANCED DIRECT OUTPUT

Output of direct (unprocessed) signal. May be used to feed another effects unit in a chain. Note that this output is affected by the DIRECT and TOTAL Output Volume Settings as well as by the TC 2290 effects, processing the direct signal part.

If you want an output which is 'a buffered copy' of the input signal, use the ext. effects SEND 1 output. (unbalanced, and 6 dB lower than the XLR input)

(03) XLR BALANCED LEFT OUTPUT

Output of processed signal. For stereo effects you have to connect RIGHT output also. Note that on-stage the XLR outputs can be used for 'linedriving' signals to the mixing desk simultaneously with the jack outputs feeding the stage amplifier(s). If unbalancing the XLR outputs pin 3 **must** float as the output balancing is of a non-gnd lift type.

Also do not to feed the XLR outputs with a phantom power signal. Such a phantom powering will do no harm, but the maximum output drive capability will be limited approx. 6dB.

(04) XLR BALANCED RIGHT OUTPUT

Output of processed signal. For stereo effects you have to connect LEFT output also. See XLR Left output.

Check the tech.specs for wiring of the XLR connections.

6.3 THE MIDI IN- AND OUTPUTS SECTION

Use these sockets to connect the TC 2290 to your MIDI-equipped instruments or to a computer-controlled MIDI-setup. Both MIDI IN, MIDI THRU and MIDI OUTPUT are supported for maximum flexibility. The MIDI way of control is a 'one way communication'. The signals goes from outputs to inputs only.

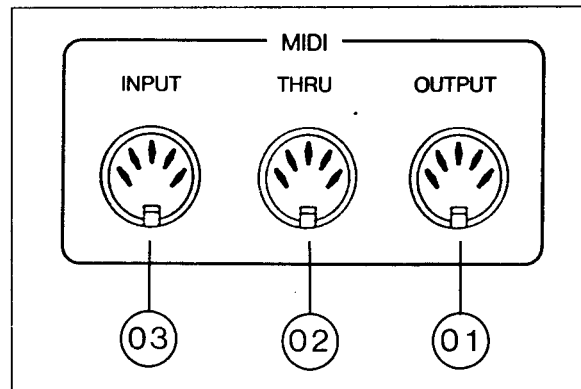

Fig.6.3 The Midi In- and Outputs Section

(01) MIDI OUTPUT

Using the MIDI output for preset shift changes, the TC 2290 can function as a 'master' in a MIDI set-up controlling other MIDI controllable effects and/or instrument preset shift changes. A keyboard player can connect the TC 2290 MIDI output to the MIDI input of his keyboard and vice versa to enable a preset shift possibility from either of the MIDI units.

When the TC 2290 is connected to another TC 2290, you can set parameters on more TC 2290's completely synchronously.

Alteration of parameters on the front panel will appear at the MIDI OUT jack as System Exclusive Data, which can be used to control another TC 2290. These MIDI exclusive output codes can also be used when the TC 2290 is connected to a computer or a sequencer capable of recording MIDI exclusive data.

The MIDI output does not retransmit the MIDI input signals of the TC 2290.

(02) MIDI THRU

Supplies an exact replica of the MIDI data coming in from the MIDI INPUT. Using the MIDI THRU socket you can link more MIDI instruments. In order to avoid data delays, however, avoid linking too many instruments via the THRU sockets. Instead you should get a MIDI THRU box, which will split a single MIDI signal into several identical signals without delay.

The MIDI THRU output is not affected by the MIDI enable frontpanel parameter, but retransmits **all** MIDI INPUT incoming data.

(03) MIDI INPUT

From this input the TC 2290 receives data from other instruments, sequencers etc. This is the socket to use when you want the TC 2290 to change presets by means of MIDI preset changes from e.g. a keyboard.

All the parameters of the TC 2290 can be controlled by MIDI System Exclusive Commands.

In this way computer programs that controls the TC 2290, display all values and give graphic representations of parameters are possible.

Also other parameters can be controlled through non exclusive MIDI codes. The sampling options features a number of MIDI controllable parameters.

Check section [8.1] for more about MIDI.

6.4 REMOTE CONTROL CONNECTIONS SECTION

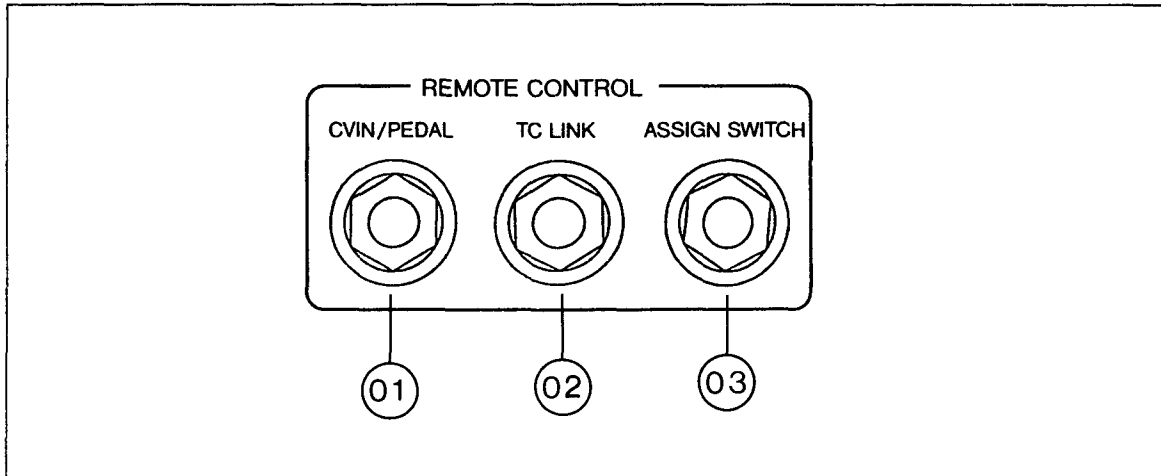

Fig.6.4. The Remote Control Connections Section

The TC 2290 offers several remote control possibilities. You've heard about MIDI but that's not the whole story. The standard TC 2290 version is supplied with 3 REMOTE CONTROL jacks.

(01) CVIN/PEDAL JACK INPUT

Reserved for future use

(02) TC LINK IN-/OUTPUT

Used to connect the TC SERIAL REMOTE CONTROLLER which gives total control over preset selection and assign keys of the TC 2290. The TC Serial Remote Controller is optional.

(03) ASSIGN SWITCH INPUT

If you connect a footswitch to this input, you will be able to 'tap' in the delay time with your foot. It doubles the functions of the <LEARN> key, see <section 5.7>

Also this input is used with the TC0050 Remote Control Panel. - A 5-switch remote control.

In the application notes section you will find a note on »How to make remote switches for the TC 2290«. In addition to this, remote key values (KEY NO. 152-155) are described in ASSIGN KEYCODE LIST in section 9.5.

6.5 THE EXTERNAL EFFECT SEND/RETURN SECTION

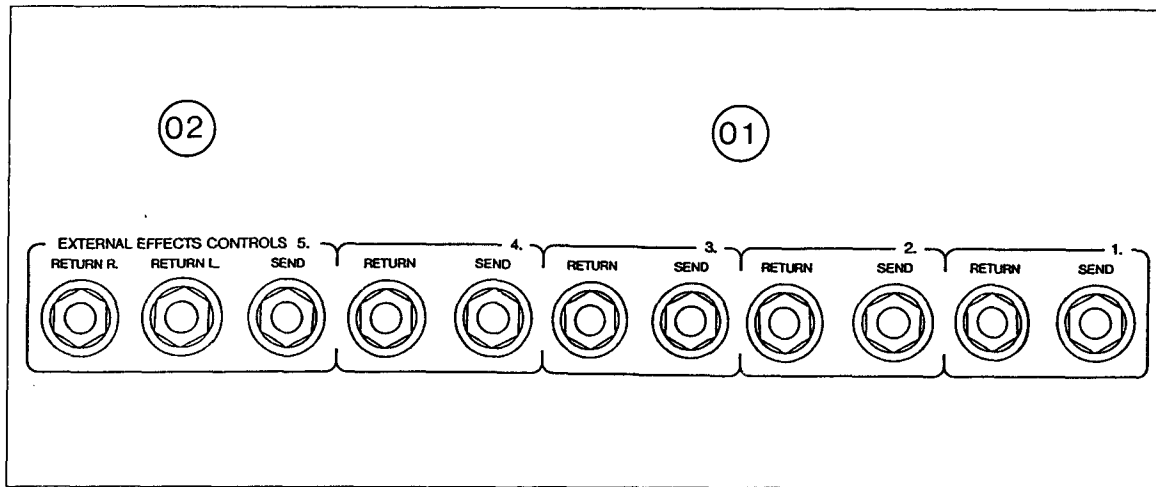

Fig.6.5. The External Effects Send/Return section

These are the sockets to use when you want the TC 2290 to control the on/off switching of your other effects units. If you connect your effects to the send/returns, the TC 2290 can decide whether the effects should or should not be a part of the output signal, simply by switching the return on and off.

(01) SEND/RETURN LOOPS 1-4

These are four identical loops which function in exactly the same way. Connect the <SEND> from the TC 2290 to the input of your effects unit, and take the output of your effect to the <RETURN> input of the TC 2290. Now switch your effects unit to the ON position, and you are ready to program this effects device into any of the TC 2290 presets. But make sure that the LED corresponding to the send/return loop is lit, and the effect will be a part of the input to the TC 2290. Please note that the sound of the external effects units will also be processed by the TC 2290.

(02) SEND/RETURN LOOP 5

This loop is similar to loops 1-4 except that it has got a stereo return for a stereo unit. In this way you can connect your stereo chorus or digital reverb and be able to mix their stereo effects with the effects of the TC 2290. Also the external effects RETURN 5 L & R can be used for a stereo out instrument and to get a stereo input to the stereo panning facilities of the TC 2290.

2 instruments may be mixed by using the returns of external effect 5, but this shuts out the possibility to use the normal input jack and external effects 1-4.

Please find a separate note on using the external effects control facilities. [11].

7.0 Commands List

This is short form commands list listing the necessary keypressing sequences to set or alter a given parameter.

It is organized in commands with the different sections.

7.1 Input Section:

Input Gain:

Adjust so that the red +3dB PPM momentarily lights up only on the extremes peaks of the input program.

Bypass

<DELAY ON>

Bypass method, input mute(0), output mute(1) or both(2):

<SPEC> <2><6> <ENTER> <0-2> <ENTER>

Volume of direct signal in bypass (only with bypass method= 1 & 2)

<SPEC> <2><5> <ENTER> <0-99> <ENTER>

<DELAY ON> in preset/manual (0/1 (0=in preset, 1>manual)

<SPEC> <1><6> <ENTER> <0/1> <ENTER>

7.2 Feedback Section

Feedback level:

<SELECT>'LEVEL'<UP/DOWN>/<0-99> <ENTER>

High fb-cutoff frequency:

<SELECT>'HI' <UP/DOWN> rolls between 2, 4, 8, or 33(off) [KHz]

Low fb-cutoff frequency:

<SELECT>'LOW' <UP/DOWN> rolls between 0(off), .1, .2 or .4 [KHz]

Inverting feedback signal:

<INV>'ON'

7.3 Output Section

Delay output volume, (0=no delay signal, 99=max, 0.5dB/step):

<SELECT> 'DELAY' <UP/DOWN> <0-99> <ENTER>

Direct output volume, (0=no delay signal, 99=max, 0.5dB/step):

<SELECT> 'DIRECT' <UP/DOWN> <0-99> <ENTER>

Total output volume, (0=no delay signal, 99=max, 0.5dB/step):

<SELECT> 'DIRECT' <UP/DOWN> <0-99> <ENTER>

Panning position (fixed and auto panning start position):

0-99 (0=direct Left, delay R), (99=direct Right, delay L)

<SELECT> 'PAN' <UP/DOWN> <0-99> <ENTER>

Total output volume in preset/manual: (0/1 (0=in preset, 1=manual))

<SPEC> <16> <ENTER> <0/1> <ENTER>

Direct gain in preset/manual: (0/1 (0=in preset, 1=manual))

<SPEC> <17> <ENTER> <0/1> <ENTER>

7.4 Modulation Section

GENERAL:

(no modulation takes place unless the corresponding <MOD> key is on)

To see/change modulation parameters of delaytime/panning or dynamic:

<SELECT> 'DELAY' / 'PAN' / 'DYN'

Change waveform of selected modulation:

<WAVEFORM> 'SINE' / 'RAND' / 'ENV' / 'TRIG'

Change speed of selected modulation: (0.1-10 Hz], 0.1=slow, 10=fast)

<UP/DOWN> / <-1-10> <ENTER>

Change depth of selected modulation: (0-99, 99=max, 0=no modulation)

<UP/DOWN> / <0-99> <ENTER>

DELAYTIME MODULATION EXAMPLES: *a)

Sine waveform modulation of delaytime:

<SELECT> 'DELAY' <Waveform> 'SINE' <DELAY MOD> 'ON'

(set modulation speed, set modulation depth)

Random waveform modulation of delaytime:

<SELECT> 'DELAY' <WAVEFORM> 'RAND' <DELAY MOD> 'ON'

(set modulation speed, set modulation depth)

Pitch shift through threshold controlled ramp:

<SELECT> 'DELAY' <WAVEFORM> 'ENV' <DELAY MOD> 'ON'

(speed sets pitch shift period, depth controls pitchshift)

(<SPEC><9><ENTER><0/1><ENTER>, pitch down (0), pitch up (1)

(<SPEC><1><0><ENTER><0-9><ENTER>, for threshold -48 to -24dB)

Triggered (gated) sine modulation of delaytime:

<SELECT> 'DELAY' <WAVEFORM> 'TRIG' <DELAY MOD> 'ON'

(set modulation speed, set modulation depth)

(<SPEC><9><ENTER><0/1><ENTER> = sweep start up(0) or down(1))

(<SPEC><1><0><ENTER><0-9><ENTER>, for threshold -48 to -24dB)

PANNING MODULATION EXAMPLES: *ab)

Sine modulation of panning:

<SELECT> 'PAN' <WAVEFORM> 'SINE' <PAN MOD> 'ON'

<PAN DELAY> / <PAN DIR> / <PAN DELAY+DIR> 'ON'

(speed sets panning rate, depth sets panningwidth)

Random modulation of panning: *ab):

<SELECT> 'PAN' <WAVEFORM> 'RAND' <PAN MOD> 'ON'

<PAN DELAY> /<PAN DIR> /<PAN DELAY+DIR> 'ON'
(speed sets panning rate, depth sets panningwidth)

Envelope controlled Left/Right switching of panpos.: *ab)

<SELECT> 'PAN' <WAVEFORM> 'ENV' <PAN MOD> 'ON'
<PAN DELAY> /<PAN DIR> /<PAN DELAY+DIR> 'ON'
(speed sets panning rate, depth sets panningwidth)
(<SPEC><1><1><ENTER><0-9><ENTER>, sets env.thresh. -48 to -24dB)

Triggered (ducked) sinemodulation of panning: *ab)

<SELECT> 'PAN' <WAVEFORM> 'TRIG' <PAN MOD> 'ON'
<PAN DELAY> /<PAN DIR> /<PAN DELAY+DIR> 'ON'
(speed sets panning rate, depth sets panningwidth)
(<SPEC><1><1><ENTER><0-9><ENTER>, sets trig thresh. -48 to -24dB)

DYNAMIC MODULATION EXAMPLES: *a)

SINE tremolo modulation of direct and delay output volumes:

<SELECT> 'DYN' <WAVEFORM> 'SINE' <DYN MOD> 'ON'
(set modulation speed, set modulation depth)
(DYN <REVERSE> 'ON' for opposite tremolo)

RANDOM tremolo modulation of direct and delay output volumes:

<SELECT> 'DYN' <WAVEFORM> 'RAND' <DYN MOD> 'ON'
(set modulation speed, set modulation depth)
(DYN <REVERSE> 'ON' for opposite tremolo)

ENV for Compressing/Overcompressing of delay output volume:

<SELECT> 'DYN' <WAVEFORM> 'ENV' <DYN MOD> 'ON'
(speed sets 'turn up volume' rate, depth sets compressing depth)
(DYN >RESERVE> 'ON' for expand of **both** delay and direct signals)
(<SPEC><1><2><ENTER><0-9><ENTER>, sets trig thresh. -48 to -24dB)

TRIG for Ducking of delay output and feedback

<SELECT> 'DYN' <WAVEFORM> 'ENV' <DYN MOD> 'ON'
(speed sets 'release' rate, depth sets compressing depth)
(DYN <RESERVE> 'ON' for gating of delay and feedback signals)
(<SPEC><1><2><ENTER><0-9><ENTER>, sets trig thresh. -48 to -24dB)

Notes, for a better monitoring of the effect, turn up *a) the delay or *b) direct volumes

7.5 Panning Section

GENERAL:

For **any** panning to take place at least one of the 'DIRECT'/DELAY' LEDs must be 'ON'
For any automatic panning modulation to take place also <PAN MOD> **must be 'ON'**

EXAMPLES:

Autopanning of delayed signal:

<PAN DELAY> 'ON' + <PAN MOD> 'ON'
(set modulation parameters in Modulation Section)

Autopanning of direct signal:

<PAN DIRECT> 'ON' + <PAN MOD> 'ON'

(set modulation parameters in Modulation Section)

Autopanning of delay and direct signals:

<PAN DELAY> 'ON' + <PAN DIRECT> 'ON' + <PAN MOD> 'ON'
(set modulation parameters in Modulation Section)

Fixed panning of delay signal:

<PAN DELAY> 'ON'
(set static pan position in Output Section)

Fixed panning of direct signal:

<PAN DELAY> 'ON' + <PAN DIRECT> 'ON'
(set static pan position in Output Section)

Fixed panning of delay and direct signals:

<PAN DELAY> 'ON' + <PAN DIRECT> 'ON'
(to set opposite pan position in Output Section)

7.6 Dynamic (DYN) Section

Dynamic volume modulation on/off:

<DYN MOD> 'ON'/'OFF'

Reverse dynamic modulation:

<DYN REVERSE> 'ON' <DYN MOD> 'ON'

7.7 Delay Section

Set Delay time:

<DELAY UP/DOWN> <0-1023> <ENTER>
(0-1023 mSec without options, from 0 to 999 one decimal allowed)
(with memory options up to 32.768 seconds is possible)

Delay time modulation on/off:

<DELAY MOD> 'ON'/'OFF'
(set parameters in modulation section)

Sample (hold/repeat):

<SAMPLE> ;without the sample option PROM, this is a simple HOLD/REPEAT function. Pressing <SAMPLE> enables a continuous repeat of the last 1023 mSec of playing until <SAMPLES> is pressed again. (With memory option the 1023mSec is variable using spec.no. 38.) See separate description for functions with sample options.

'Learn' delaytime of the beat rate:

<LEARN><LEARN> ; delaytime becomes the time between the 2 keystrokes.

7.8 Numeric Keyboard

Changing values:

Once any <UP/DOWN> key has been pressed, (a green LED above starts flashing and) a new parameter value for that function can be entered using the numeric keyboard. The entered value will **not** be active until <ENTER> is pressed. Also <PRESET>, <MIDI CHANNEL> and <SPEC> use the numeric keyboard

After a <PRESET><number><ENTER> sequence the last preset cipher starts blinking indicating 'SINGLE KEY PRESET SHIFT MODE'. In this mode any <0>-<9> keypressing effects an immediate preset shift within the 'decade' or 'bank'

<CHANGE> and <STORE> does not need <ENTER> as terminator!

Cancel a numeric keyboard access to a parameter:

<><>

7.9 Preset Section

(see appendix to this chapter for more on preset & store)

Recall a preset and enter 'Single Key Preset Shift Mode':

<PRESET> <0-99> <ENTER>

In 'Single Key Preset Shift Mode:

<0-9> ;shifts to new preset within same bank

Store frontsettings:

<PRESET> <0-99> <STORE>

Protect all preset above a number:

<SPEC> <8> <ENTER> ; shows number of first protected preset
<1-100> <ENTER> ; to set new preset protect number.

Restore all factory presets (80-99):

<SPEC> <3><7> <ENTER> ; shows '2290'
<1> <ENTER> ; to recall factory presets on next
<POWER> 'OFF' ; power off/on
<POWER> 'ON' ; error # 13 is shown in delaytime display
<SPEC> <2><3> <ENTER> ; write to special number 23, the value '0'
<0> <ENTER> ; to tell TC 2290 'I'm aware, that presets
; are lost'

7.10 Assign Section

See separate list in sec. [9] for key code list and more examples:

Program ASSIGN KEY A to be a <LAST PRESET> key:

<SPEC> <4> <0> <ENTER> <3> <6> <ENTER>
<SPEC> <4> <1> <ENTER> <1> <9> <9><ENTER>

To show keycode numbers of pressed keys in delaytime display:

<SPEC> <2><2> <ENTER>

Cancel 'show keycode':
<**DELAY UP**>

7.11 Midi Section

Enable MIDI input:
<**ENABLE**> '**ON**'

Set MIDI Send (& and receive if OMNI = OFF) Channel:
<**CHANNEL**> <**1-16**> <**ENTER**>

Set MIDI OMNI on (to receive on all channels):
<**SPEC**> <**5**> <**ENTER**> <**0**> <**ENTER**>

Set MIDI OMNI OFF (to receive on only on current channel #):
<**SPEC**> <**5**> <**ENTER**> <**1**> <**ENTER**>

7.12 External Effects Section

Switch in/out an external effect:
<**CHANGE**> <**1-5**>

Switch in/out all external effects:
<**CHANGE**> <**0**>

7.13 Special (Spec) Section

To set a special parameter:
<**SPEC**> <**number**> <**ENTER**> <**value**> <**ENTER**>
(where <number> is a valid special number and <value> is a valid special value of the chosen special number)

Check sec [9] for a list of available special number parameters and values.

RECALLING PRESETS

GENERALLY:

To recall a preset and enter the 'SINGLE KEY PRESET SHIFT MODE', press:

<PRESET> ; tells 2290 to expect a preset no.
<number> ; enter a 1 or 2 digit number on the numeric keyboard
<ENTER> ; preset 'number' is recalled, last cipher starts
; blinking, indicating 'SINGLE KEY PRESET SHIFT MODE'

With no number given, the current preset no. is recalled.

'SINGLE KEY PRESET SHIFT MODE'

In this mode (indicated by last preset cipher blinking) any preset number within the bank (decade) is recalled instantly by pressing any single numeric key number.

Any key capable of 'reaching' the numeric keyboard i.e : <UP/DOWN>, <PRESET>, <MIDI CH.>, <CHANGE>, <SPEC> or <.> stops 'SINGLE KEY PRESET SHIFT MODE'

EXAMPLES:

<PRESET><ENTER> ; recalls currently shown preset no. settings
; and enters 'SINGLE KEY PRESET SHIFT
; MODE' , as indicated by last preset cipher.

<PRESET><8><1><ENTER> ; recalls preset 81, shifts to preset bank 8
; (last preset cipher starts blinking).

IN 'SINGLE KEY PRESET SHIFT MODE' (last preset cipher blinking):

<0> ; recalls preset no.0 within bank
<7> ; recalls preset no.7 within bank

any <UP><DOWN> or <.> stops 'SINGLE KEY PRESET SHIFT MODE'

STORING/UPDATING/COPYING/MOVING PRESETS

GENERALLY:

To store frontsettings in a preset:

<PRESET><number><STORE>

With no number given, frontsettings are stored into current preset no.

A non-succesful store will result in the display of either

error no. 3 : preset is protected, you cannot store in this preset no.
 (presets 80-99 are from factory set write-protected,
 but you can change this if you want, see 'special'
 section [9.4] on how to protect presets.)

error no. 4 : incorrect key sequence before <STORE>

You may have noticed that pressing <STORE> key alone has no effect (except the display of error no. 4). It is simply to avoid 'updating' your presets accidentally !

EXAMPLES:

<PRESET><2><STORE> ; stores front settings into preset 2
 ; (and jumps to preset 2)

<PRESET><STORE> ; updates current preset no. with changed
 ; frontsettings.

<PRESET><STORE> ; updates current preset no. with changed
<ENTER> ; frontsettings and enters SINGLE KEY
 ; PRESET SHIFT MODE

<PRESET><8><1><ENTER> ; copy preset 81 to preset 3.
<PRESET><3><STORE> ;

<PRESET><2><STORE> ; copy front settings into preset 2, 13 & 22.
 <1><3><STORE> ;
 <2><2><STORE> ;

<PRESET><2><ENTER> ; fetch preset 2
<PRESET><1><STORE> ; save temporarily in preset 1
 <8><ENTER> ; fetch preset 8
<PRESET><2><STORE> ; save in preset 2
 <1><ENTER> ; fetch preset 1
<PRESET><8><STORE> ; save in preset 8
 ; to switch position of preset 2 and preset 8.

8.0 Practical Performance Hints

When using the TC 2290 capable of doing so many different things, it can take some time to get acquainted with the functions as well as to figure out what to use these facilities for. This section gives a shortcut to some of the common applications, as well as some practical tips and hints. Please note that also the application notes section [11] contains some notes on practical performance hints.

Organize Your Presets

When you need to reorganize or make additions to your library of presetsounds, you may sometimes be in doubt, as to whether you can delete a preset.

100 presets are a lot. Make a rule for yourself; – presets you don't intend to keep are many recognizable e.g. all presets where you have stored the factory preset 80 settings are presets you are not currently using.

Another option is to stay in e.g. bank 0 while experimenting and then copy the more usable of these presets into higher bank numbers for actual use.

It is easy to overwrite a lot of presets with equal presets. After recalling preset 80, the sequence:

<PRESET><1><STORE> <2><STORE> <3><STORE> ..etc. until <1><5><STORE>

will copy preset 80 to presets 1-15.

<SELECT> What You Want to Access

Note that all <SELECT> rolling positions are stored as well. This means that when storing the preset, you actually select which functions or parameters are 'ready' to be affected with the corresponding <UP/DOWN> keys when you later recall the preset again.

So set the <SELECT> rolling functions for what you think potentially need your direct access recalling the preset.

Using <SAMPLE> to Check Your Sound:

When setting up equipment for live performance, it is very easy to <SAMPLE> some seconds of playing. Like this you get the freedom to leave the stage and check your own sound as heard by the audience. – Take care not to blame your technicians too heavily the first time you hear yourself doing live performance.

Characteristic Delaytimes for given effects:

Delaytime Effect		Dlymod Feedback	
0-10	Flanger	ON	Quite High
5-50	Chorus	ON	Slight or none
20-80	Double Track	ON	Slight or none
50-150	Slapback Echo Enhancing Rhythmic Patterns	OFF	Small rooms
100-500	Echo	OFF	'number of repeats'
300-up	Sampling Effects	OFF	'sound on sound' & sampling of echo repeat patterns.

Delay panning (Haas) effects <1mS
 Filterlike effects < 5mS
 Spatial stereoimage widening 5-40mS
 Ambience effects 5mS to 150 ms
 Echo repeating effects >100 mS

Manual Control of Selected Parameters

The <POWER ON/OFF> switch setting is unaffected by preset changes. You can select other parameters to be similarly unaffected by presetchanges.
 In some instances it is desirable to control some parameter 'manually' instead.

This happens e.g. when the 2290 is used as an 'add-on effect' in connection with a mixer. Here the direct signal part of 2290 output must be muted. This can of course be accomplished by changing every preset dir volume to 0. However it is a lot easier to just tell 2290 that you want manual control of direct volume, and then set direct volume to 0.

Consider e.g. the <**DELAY ON**> (bypass) function. On 2290 this function is normally in preset, this allows for thinking in sounds only, each sound being a preset with some effects combinations. Bypass is a preset with delay (and external effects) off.
 If however, you want to operate in more 'tradition' ways, you can take the <**DELAY ON**> function out of preset. This means that the <**DELAY ON**> status is affected only by activating the switch – not by changing preset.

On 2290 the following functions can be selected to be manually operated = non- presetable, (all of the functions are by default presetable).

<**DELAY ON**>

non-presetable <**SPEC**><1><4><**ENTER**> <1><**ENTER**>
 presetable <**SPEC**><1><4><**ENTER**> <0><**ENTER**>

<**SAMPLE**>

non-presetable <**SPEC**><1><5><**ENTER**> <1><**ENTER**>
 presetable <**SPEC**><1><5><**ENTER**> <0><**ENTER**>

Total output volume

non-presetable <SPEC><1><6><ENTER> <1><ENTER>
presetable <SPEC><1><6><ENTER> <0><ENTER>

Direct output volume

non-presetable <SPEC><1><7><ENTER> <1><ENTER>
presetable <SPEC><1><7><ENTER> <0><ENTER>

Ext.effects

non-presetable <SPEC><1><8><ENTER> <1><ENTER>
presetable <SPEC><1><8><ENTER> <0><ENTER>

Please note that when storing a preset, it is the actual status as seen on the front that is stored – **even if the function is set to 'manual' control!!**

This guarantees that 'what you see & hear is what you get'.

So, if you later enable preset control of these functions, it is the actual settings at the time of the last store to the preset, that will be recalled.

Keyboard Lock:

As you now know the numeric keyboard is 'caught' by any key below the green leds, e.g. the <UP>/<DOWN> keys. However this can be altered so that the keyboard 'locks' to the parameter you want.

This is done by changing the special no. 19 value to '1'.

With Spec # 19 set to '1', a '<ENTER> <ENTER>' locks the function to keyboard and a double <><> cancels the LOCK.

Examples:

Set keyboard-Lock possibility on: <SPEC><1><9><ENTER> <1><ENTER>

Having done this, it is now possible to LOCK keyboard on e.g.

PRESET (to keep 'SINGLE KEY PRESET SHIFT MODE')

To LOCK keyboard on PRESET:

<PRESET> ; to get the keyboard on preset shift function

<ENTER><ENTER> ; double <ENTER> to LOCK keyboard

Now you can do any <UP> <DOWN> without 'catching' the keyboard (note the GREEN PRE-SET LED keeps blinking, showing that keyboard access remains on preset function).

To UNLOCK keyboard from preset and LOCK keyboard to DELAYTIME instead:

<><> ; double point to cancel any LOCK

<DELAY UP> ; to get keyboard on delaytime)

<ENTER><ENTER> ; double <ENTER> to LOCK keyboard onto delaytime)

Please note that by LOCK'ing the keyboard to some function you can only prevent <UP> <DOWN> functions from catching the keyboard (If this wasn't so you could not change preset, ext. effects or spec.no./val).

To remove the Keyboard-Lock possibility:

<SPEC><1><9><ENTER> <0><ENTER>

PAN Sweeps Synchronized to the Rhythm

Using the 'PAN' 'ENV' Modulation

By using the 'PAN' 'ENV' modulation waveform the signals can be synchronized to the rhythm so that the signals appear alternatingly in left and right.

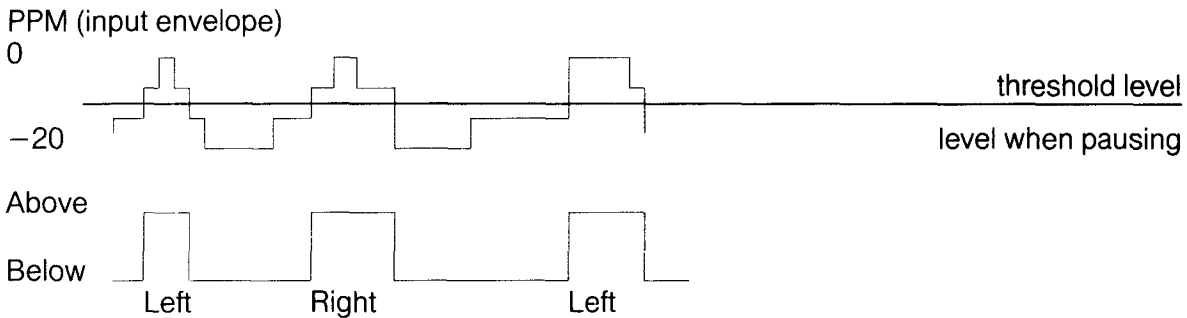

Fig. Each time you play after a slight pause, the input signal envelope level passes from below threshold to above threshold, and the panposition sweeps to the opposite side.

Synchronizing Pan Sweep Rate and Delaytime with the Beat

Here is how to calculate and a lookup-chart to match the pansweep and the delaytime to the beat (tempo) so that there are 1, 2, 3 or 4 beats or echoes on a complete pan-sweep (Note that a pan sweep is from startposition and back. E.g. from Right to Left to Right).

Matching Pan Sweep Rate to the Beat:

Calculate SPEED:

1 beat/sweep:
set SPEED at tempo/60

Start at Right

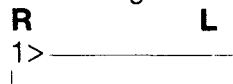

Start from Middle

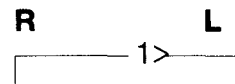

2 beats/sweep:
set SPEED at tempo/120

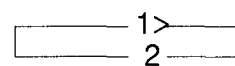
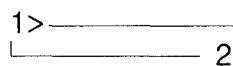

3 beats/sweep:
set SPEED at tempo/180

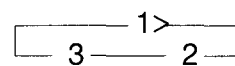
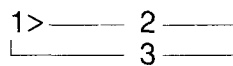

4 beats/sweep:
set SPEED at tempo/240

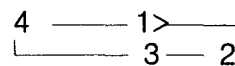
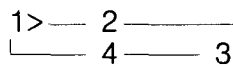

Look-up Chart to match PAN Speed and Delaytime to Tempo

Example 1:

At tempo 100, echo must be on the beat.

This means delaytime must be set at 600 mS

Example 2:

At a delaytime of 125mS 2 echos/pansweep are wanted this means pan SPEED should be set at 4.0 (Hz)

	Tempo = Delaytime		Beats or Echoes pr. sweep			
	(bpm)	(mS)	1	2	3	4
			set PAN SPEED to (Hz)			
		100	10	5.0	3.3	2.5
		111	9.0	4.5	3.0	2.3
2)		125	8.0	4.0	2.7	2.0
		143	7.0	3.5	2.3	1.8
		167	6.0	3.0	2.0	1.5
		200	5.0	2.5	1.7	1.3
	240	250	4.0	2.0	1.3	1.0
	200	300	3.3	1.7	1.1	.83
	180	333	3.0	1.5	1.0	.75
	160	375	2.7	1.3	.88	.67
	150	400	2.5	1.3	.80	.63
	140	429	2.3	1.2	.78	.58
3)		130	2.2	1.1	.72	.54
		120	2.0	1.0	.67	.50
		110	1.8	.92	.46	.61
1)		100	1.7	.83	.56	.42
		90	1.5	.75	.50	.38
		80	1.3	.67	.44	.33
		70	1.2	.58	.39	.29
		60	1.0	.50	.33	.25
		54	.90	.45	.30	.23
		48	.80	.40	.27	.20
		42	.70	.35	.23	.17
		36	.60	.30	.20	.15
		30	.50	.25	.17	.13

Example 3:

At tempo 130, 3 beats/pansweep is wanted this means pan SPEED should be set at 0.72 Hz

Synchronizing Flanger Sweeps to The Music

Usually flanger sweeps are set at quite slow speeds, so it is not relevant trying to match the sweep rate to tempo (although it is quite with rhythmic patterns). Instead the sweep can be 'synchronized' to the music simply by turning on/off delaytime modulation.

Each time <DLY MOD> is turned off or the TC 2290 is bypassed (<DELAY OFF>) the delay time modulation sweep is stopped.

To synchronize a flanger sweep to start at exactly the same sweep position is then as simply as turning on/off <DLY MOD> (or bypass on/off).

With Spec. #9 you can control the start direction of the sweep (up or down).

Matching Delaytime to Sequenced Patterns

If you are using a lot of sequencer and rhythm devices, you should try delaying repetitive patterns like arpeggios and hi-hat figures. Using a delaytime that is an integral of the tempo of the music, slightly adjusted a bit shorter to push the feel a bit forwards or make it a bit longer to pull the feel backwards.

Such manipulations can add unexpected life to an otherwise somewhat »dead« pattern. With a tempo of 120 beats per minute, try out delay time settings 125, 250, 375 and 500 mS respectively.

Matching delay time to an integral of the beat can be done using a simple formula if you know the time between each beat. This can be 'tapped' in with the <LEARN> key.

Or you can use the beats per minute (bpm) number.

Dividing 60 with bpm gives you the time between each beat, or 'on beat time', Knowing the 'on beat time' it is a simple matter to find other matching delaytimes.

to get 1/4 (on beat time), tap <LEARN>, or divide 60 by bpm then,
for 1/8 (halfbeat) : divide 'beat time' with 2
for 1/16(quarterbeat) : divide 'beat time' with 4
for 1/4 triplets : divide 'beat time' with 1.5
for 1/8 triplets : divide 'beat time' with 3

example:

Tempo = 130 bpm

1/4 (on beat time) equals $60 / 130 \text{ beats/sec.} = 0.462 \text{ sec.} = 462 \text{ mS}$

for 1/8 (halfbeat)	: 462 mS/2	= 231 mS
for 1/16 (quarterbeat)	: 462 mS/4	= 115 mS
for 1/4 triplets	: 462 mS/1.5	= 361 mS
for 1/8 triplets	: 462 mS/3	= 180 mS

If you want to know the beats per minute, tapping the <LEARN> key on the beat will give you the delaytime corresponding to the beat. Then to get the tempo (beats per minute) you must divide 60 by the delaytime. An example:

Hitting <LEARN> gives delaytime 400 mS, that is 0.400 seconds, then tempo equals 60 divided by 0.400 = 150 (beats per min.)

Linking TC 2290 with a Sequencer for Automatic Preset Switching

When used in a studio environment, the TC 2290 is actually capable of a whole lot more than just delaying signal in various ways. If your studio runs some kind of common synchronization and you are using MIDI sequencers, the TC 2290 can be set to perform real-time preset and input switching.

Check the MIDI section [8.1] for some notes on this subject.

Panning a stereo input signal

As seen on the block schematics the stereo autopanner has two inputs. These can be made available both of them, by using the ext. effects 5 left and right inputs and setting the delaytime at zero.

In this way it is possible to 'rotate' a stereo input signal, making left appear at right and vice versa.

The output section pan position controls the pan modulation 'off' rotation as well as the start (and stop) position of the pan sweep when automatic panning is applied.

'Delay panning'

If one side of a stereo signal is delayed slightly (up to 1 mS) and this delay is modulated by a slow sine yet another kind of panning is possible.

This is due to the phenomenon of psychoacoustic localization of sound based on the relative delay of the sound reaching our ears. Also it is called the 'Haas' or 'forward inhibition' effect. With sound travelling in air at a speed of 340m/sec. each 34 cm corresponds to a delay of one millisecond. If the sound source is not right in front (or back) of us the sound reaches the nearer ear and the farther ear of our ears at different times.

We simply use this slight delay difference to localize the origin of the sound.

As the distance between our ears corresponds to a delaytime of max. 1 mS this is also the max. delaytime needed to 're-position' our experience of the **origin of the sound**.

Panning and Delay Panning Simultaneously

By setting the modulation speed values to equal values and turning <PAN MOD> and <DELAY MOD> on at the same time the PAN and DLY sweeps will synchronize in one way, turning the two <MOD>s on at different times will change the 'phase' of the sweeps.

With the <SPEC><9> the direction of the delay time sweep can be reversed.

8.1 MIDI with the TC 2290

If you don't know or would like to refresh what MIDI is there is a separate note tc-apn.06 'What is MIDI' in sec. [11].

8.1.1 MIDI Applications with the TC 2290

If you own instruments with MIDI, the TC 2290 will be even more attractive to you, as you can connect it to your instruments in various ways.

The application you will be using most is probably the linking of the TC 2290 presets to the presets of your electronic keyboard, so you will be able to recall both the preset sound of your keyboard and the accompanying effect on your TC 2290 at the touch of only a single key.

Especially for performing musicians this effectively reduces the number of 'keystrokes' between each tune in a busy live-situation. Using the midi exclusive midi control of the TC 2290 a lot of applications with computer and sequencer interfaces are possible. With the sampleop-tion some new possibilities are added.

8.1.2 MIDI Enable

In order to make the TC 2290 respond to MIDI IN, press the <MIDI ENABLE>. The TC 2290 will only respond to the MIDI when the LED is lit. This function is especially useful in temporarily disconnecting the TC 2290 from your MIDI system, in order to avoid some of the preset changes.

If you are setting up a sound on the TC 2290, checking with different instrument sounds (presets), it's nice, to quickly be able to disconnect the common preset changes.

If you are using a sequencer this becomes even more important, when recording, listening and setting sounds, over and over again.

8.1.3 OMNI on/off

On most of the MIDI output control informations an 'address label' is put, this is called the MIDI channel number.

With the help of an OMNI on/off control the receiver either ignores this address label and just responds to everything (OMNI on) or the receiver 'reads' and responds only if the channel 'address label' number is 'correct'.

Another way of visualizing this, is by imagining the MIDI channels as channels of a 16 track recording. The similarity is that with OMNI on all channels are heard simultaneously. Listening only to a single of the 16 tracks corresponds to OMNI off.

OMNI ON

If you have a fairly simple MIDI setup, you will probably not need the channelization possibility. Maybe you just want to run one or two polyphonic synthesizers together with your TC 2290. In this case you do not have to bother about channels at all.

The MIDI standard has foreseen this situation and a MIDI MODE has been specified for this situation. This is called the OMNI ON mode. In this mode the connected instruments forget all about channels when receiving so that all informations on the 16 channels are responded to.

If you put your TC 2290 in OMNI ON mode, it will react to preset changes on any MIDI channel. This means that you do not have to check that the channel of your MIDI of your MIDI instrument and the TC 2290 are matching.

OMNI OFF

On the other hand, if you have a sophisticated multi keyboard setup (perhaps with a computer-based sequencer and more effects units) sequencing a lot of different instruments simultaneously, you will welcome the OMNI OFF mode in the TC 2290. In the OMNI OFF mode, the TC 2290 will only respond to MIDI information on a single channel. This means that you can hook the TC 2290 to a single keyboard in a multi keyboard setup. You can even assign a channel especially for the TC 2290 and make it change presets several times during a composition. When you are using the OMNI OFF mode you will have to take care that the MIDI channel of the TC 2290 corresponds to the MIDI channel on which you are transmitting to the TC 2290.

MIDI OMNI ON/OFF is set via Special # 5:

Examples:

For OMNI OFF, press: <SPEC> <5> <ENTER> <1> <ENTER>

For OMNI ON, press: <SPEC> <5> <ENTER> <0> <ENTER>.

8.1.4 Setting MIDI Channel

The TC 2290 is able to receive MIDI data on all 16 MIDI channels simultaneously (OMNI ON) or on individual channels (OMNI OFF).

If you are using the OMNI OFF mode, you must specify on which MIDI channel the TC 2290 should work on.

This is done with the <MIDI CHANNEL> key, to set MIDI channel, press:

<CHANNEL> <number> <ENTER>

where <number> must be from 1 to 16, omitting <number> or pressing <> will leave channel number unchanged. Entering an invalid number will cause ERROR 4 (wrong special value) and leave channel number unchanged.

Since the setting of the MIDI channels is actually a Special Function, the <MIDI CHANNEL> key might be regarded as an <ASSIGN KEY> that has been permanently assigned to do a '<SPEC> <4> <ENTER>' keystroke. When pressing the <MIDI CHANNEL>, the current MIDI channel appears in the Delay Time Display. You will notice that the LED display. 'S.VAL' appears in the right side of the Delay Time Display indicating that you are actually setting a Special Value, when setting the MIDI channel.

8.1.5 Linking TC 2290 and Keyboard Presets

Okay, you now want to link a specific preset on the TC 2290 to one or more presets on your MIDI keyboard.

Simply connect the cables as described in sec. [4.5]

(Keyboard MIDI OUT to TC 2290 MIDI IN and vice versa)

Check that your keyboard OMNI is on (or if you need OMNI off set the keyboard channel to the channel of TC 2290).

Also check the TC 2290 Omni is on (or if you need OMNI off and correct channel number).

Now with MIDI ENABLE on, preset changes on your keyboard should effect a preset change on the TC 2290 and vice versa.

If you have an old MIDI keyboard, you may experience that the preset numbers do not correspond, check sec. [8.1.6] about this.

If you connect remote controls to the TC 2290 it is possible to control the preset of your keyboard as well.

8.1.6 Preset numbers differ

The MIDI spec. leaves room for 128 different programs, but most instruments do not have more than 64 presets due to limited memory capacity. The TC 2290 has 99 user-programmable presets which are about enough to cover most applications.

The TC 2290 presets will match the MIDI presets definitions, i.e. MIDI preset no.10 will correspond to TC 2290 preset 10.

Although some standards have been agreed in the MIDI specifications, several manufacturers have frequently violated these 'rules' to save a few cents in the cost of manufacturing.

Some keyboards are equipped with another preset numbering system, that runs in 'machine-language' (octal). In order to 'humanize' the system to the user, the manufacturer has chosen to present it as a system of 8 banks of 8 presets giving the numbers from 11 to 88. (64 in total).

If your midi keyboard has been limited in this way, you need to 'translate' from the 'computer number' to the plain English number. This is most easily made by looking in a 'translation-list.' It is possible to calculate the number if you are clever in doing so. Please find a translation-list at the end of this chapter.

Other instruments have only 16 or 32 presets. Typically, these instruments 'fold over' and continue from the beginning again if you exceed the maximum preset number, e.g if you command:

 preset 17 ; it takes preset 17-16 = 1
or preset 36 ; they take preset 36-32 = 4 or 36-16-16 = 4

8.1.7 MIDI Exclusive Control

All the parameters of the TC 2290 can be controlled through MIDI exclusive codes, also TC 2290 is able to send out all keypressings as well as the current frontpanel settings out as MIDI exclusive codes.

These facilities can be used for 3 purposes.

1. With sequencer recordings of the frontpanel keypressings.
2. Linking more TC 2290 together. The Linking of more TC 2290 is simply done by connecting the MIDI out cable from one TC 2290 to another. The 2 special numbers enabling MIDI exclusive input and output codes must be set. [9.4]
3. Computercontrol
Optional programs for specific computers controlling the TC 2290 will be announced in the TC Software Club Newsletter Also a protocol description will be made available as an application note.

8.1.8 Using TC 2290 with MIDI Sequencers

A normal taperecorder cannot record midi activities (MIDI is at a too high frequency) – for this purpose, a sequencer or a computer with a sequencer program is used.

A sequencer is like a tape recording of the midi activities. – just that instead of recording to tape, the record is to an electronic memory. You can playback at different speeds to get different tempos.

The pitch does not change when you playback as with a taperecorder because, again, it is **control data** that is replayed – **no sound** has been recorded. (In fact not even the control data is pitchshifted, as the control data is tempo-shifted by shortening/increasing **pauses** between data)

If the sequencer is able to record MIDI exclusive codes, **all keypressings on the TC 2290** can be recorded for later playback.

Sequencers differ

Not all sequencers are able to record and playback midi exclusive codes, this is mostly due to limited memory capacity of the sequencer. Physically there are no differences between non exclusive and exclusive midi messages.

The most versatile sequencers are based on a personal computer with some added midi in/out hardware and a program. – But also here, not all sequencer programs are able to recognize, record and playback exclusive codes.

If the sequencer is not able to record midi exclusive codes, but only standard midi messages, then you can take advantage only of the preset shift activities.

(And some more with the sample option.)

Exclusive channelization

With the exclusive communication the channelization of MIDI has no effect. Having more than one TC 2290 connected to the MIDI chain, this does not mean however, that you cannot direct the exclusive control to and from the specific TC 2290 device you want. By setting different ID-numbers, the exclusive codes can be directed to specific TC 2290's (spec.no.1).

Take care with the <ENABLE> key

If your sequencer is able to record the MIDI Exclusive codes take care not to use the <MIDI ENABLE> key when recording. The sequencer will also record that you touch the <MIDI ENABLE> key, disconnecting further TC Exclusive recording:

BAR	BEAT	TC 2290 KEYPRESSINGS	SEQUENCER RECORDS
1	1	<PRESET><1> <ENTER>	<PRESET><1> <ENTER>
	2		
	3	<MIDI ENABLE> (off)	<MIDI ENABLE>
	4		
2	1	<2>	nothing
	2		
	3	<MIDI ENABLE> (on)	nothing
	4		
3	1	<3>	<3>
	2		
	3	<4>	<4>
	4		

Playing back this sequence gives the first preset 1 change, but after that – nothing happens!! (because the only recorded <MIDI ENABLE> disconnects the TC 2290 midi input thus from doing the preset 3 and 4 shifts).

appendix, Preset numbers differ

Some instruments are equipped with another preset numbering system that runs in 'machine language' (because it saves a few cents). The manufacturer then has, (in order to 'humanize' the system to the user) chosen to present it as a system of 8 banks of 8 presets giving the numbers from 11 to 88. (64 in total).

To convert from this 'machine language' to decimal system you can subtract the lefthand digit * 2 and then subtract 8:

e.g. 11 in 'machinelanguage' equals $11 - 1 * 2 - 8 =$ preset no. 1

or 22 in 'machinelanguage' equals $22 - 2 * 2 - 8 =$ preset no. 10

or 88 in 'machinelanguage' equals $88 - 8 * 2 - 8 =$ preset no. 64

Or you can look up here:

2290	other	2290	other	2290	other	2290	other
	+10		+14		+18		+22
01	11	17	31	33	51	49	71
02	12	18	32	34	52	50	72
03	13	19	33	35	53	51	73
04	14	20	34	36	54	52	74
05	15	21	35	37	55	53	75
06	16	22	36	38	56	54	76
07	17	23	37	39	57	55	77
08	18	24	38	40	58	56	78
	+12		+16		+20		+24
09	21	25	41	41	61	57	81
10	22	26	42	42	62	58	82
11	23	27	43	43	63	59	83
12	24	28	44	44	64	60	84
13	25	29	45	45	65	61	85
14	26	30	46	46	66	62	86
15	27	31	47	47	67	63	87
16	28	32	48	48	68	64	88

8.2 SAMPLING WITH TC 2290

Using Standard Prom 26.5

standard PROM version 26.5 offers only limited sampling possibilities (hold/repeat function).

Sampling Option 1 Offers :

	Using Keys:
Delay/Sample mode with split memory possibility for sample and delay functions so that samples are not destroyed when using delay.	<SAMPLE>
Record/Edit	<KEY A>
Record/Playback trig facilities:	
Trig and re-,re-,re trig functions	<LEARN> or
Remote trig or	<MOD> or
Input signal level triggered	
Midi triggered - playback only	
Metronome trig	
Edit sam-,-ampl-,samples	<UP/DOWN> and/ or num. keyboard
Front and Rear edit of sample	<KEY B>
Record multiple samples (max.100) and do 'Punch in' recordings	
Multiple playback 'windows' of samples (presetable)	
Variable pitchshift on playback	<SPEC.NO>
Up to 2 seconds tot. sample time without memory options	
Up to 32 seconds total sample time with memory option.	

Sampling option 2 adds:

Extended MIDI controls
MIDI keyboard triggered
and controlled pitchshift sample playbacks (w.keyboard splits)

SAMPLING OPTION POSSIBILITIES

Imagine the 2290 as a tape recorder. A recorder having variable playback speed and - most important - is able to spool in zero time.

All parameters are controllable in various combinations from a number of sources:

Setting start/stop recording and playbackpoints

On the frontpanel of 2290, or from a computer, store in presets

Trig recording and playbacks from:

Triggered by the level of the input signal (sync) or

The frontpanel of 2290 or

Remote switches or

The midi input, either from a keyboard, a sequencer or a computer-playback
only

Playback sample selection and speed (the pitch) being controllable from:

The frontpanel of 2290 (stored in presets)

The midi input, which can be from a keyboard, a sequencer or a computer
(option2)

This raises a number of possibilities, e.g:

Recording

a sung sequence of words, e.g.:

do the hop, toward the top'

Editing

by setting up a number of different playback start and stop points:

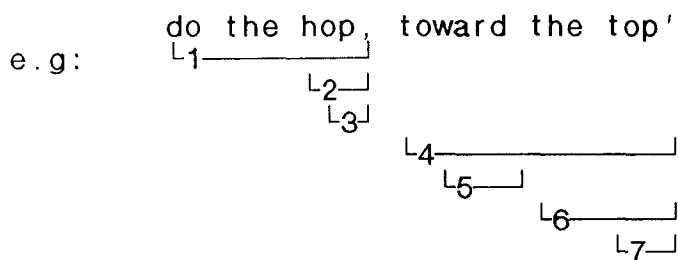

(and storing those start/stop points in 7 presets) will allow you to

Playback combinations like:

playing:

'do''do the hop'

'to''toward the top'

'toward the t''t''top'

'do''do the''op'

'op''top''op''top''op''top'

'op''ward''op''ward''op''ward'

'd''d''d''do''the top'

w. sample(parts):

1,1

4,4

4,7,7,7,

1,1,3

3,7,3,7,3,7

3,5,3,5,3,5

1,1,1,6

How is playback done ?

Playback is done by :

1. selecting between the 7 presets (each of them 'pointing' with start/stop points at a part of the recorded sample). Selection is done:

by pressing the right numeric keys on the front of the 2290 (in the 'singlekey' presetshift mode) or
from remote panel
or shift presets with the help of a midi keyboard or sequencer

2. triggering playback of the sample-part:

by playing your instrument or
pressing the <LEARN> key (on the front or remote)
or triggering by playing selected notes on a midikeyboard.

A sequencer can do this very elegantly, handling the preset shift (sample extraction), triggering & pitchshifting as well.

You also can do pitchshifts, sample option 1 has limited prefixed pitchshifts, stored with each sample-extraction, while option 2 offers midi keyboard controlled pitch shift.

8.3 TC 2290 Options

HARDWARE

Order	Description	Available
ME04	Memory Expansion to 4 seconds total	now
SA01	Sampling option no. 1 including programmable editing, audio trig, manual triggering, adjustable threshold, metronome (= internal clock), manual pitchshift and prerecording. Requires ME04.	now
SA02	Sampling option no. 2 with same features as sampling option no. 1 plus a second head D/A converter, sequencer, crossfade, and sound on sound. Requires ME04.	now
FATR	Performs fast and precise triggering of samples. Requires SA02.	now
STSA	Monocompatible stereo delay and stereo sampling without phase shiftings, when 2 TC 2290s with STSA are linked together. Requires FATR.	now
ME11	Memory Expansion card to 11 seconds. Requires ME04 and SA01/SA02.	now
ME00	Empty memory board prepared for memory expansion up to 32 seconds in units of 4 seconds. Requires SA01/SA02.	now
CH04	Memory unit for mounting in the empty ME00 Board. 1 CH04 = 4 seconds memory expansion. Maximum memory of 32 seconds = 7 x CH04. 1 x CH04 = 4 DYN RAM 1 Mb (type 511000-12 or 511000-15). Requires ME00.	now
TC0050	Remote Controller, 4 Remote Assign Switches + <LEARN, TRIG> foot contr. panel for stage use.	now
TC0144	Serial Remote Controller. advanced 14 switch, foot control for stage use.	now
H-2	Front Handles, type	now

SOFTWARE

Apply for TC Software Club Membership and receive newsletters on the new software (sampling etc.) and availability.

New Hardware options will also be announced here.

9.1 FACTORY PRESETS

PRESET No.	Name	Delay	Feedb.	Modulations		
				Panmod	Dynmod	Dlymod
80	Long Delay	1023	0	.	.	.
81	Chorus + Pan	50	15	on	.	on
82	Dyn Delay Trig	850	25	.	on	.
83	Preset 82 + Pan	850	25	on	on	.
84	Delayed Dyn Chorus	300	20	.	on	on
85	Chorus	20	0	.	.	on
86	Flanger I	10	50	.	.	on
87	Delay Dyn Reversed	200	50	on	on	on
88	Dyn Delay+Pan Env	500	25	on	on	on
89	Dyn Delay+Pan Env	300	25	on	on	on
90	Dyn Delay+Pan Env	250	25	on	on	.
91	Flanger II	20	55	.	.	on
92	AutoPan Direct	0	0	on	.	.
93	Tremolo Direct	0	0	.	on	.
94	AutoPan+Tremolo Dir	0	0	on	on	.
95	Doubler I	80	25	on	.	on
96	Delay short + Dir Pan	100	35	on	.	.
97	Doubler II	30	15	on	on	on
98	Chorus+Pan+Tremolo	10	0	on	on	on
99	Flanger III	1.8	78	.	.	on

until you change:

0-79	Long Delay	1023	0	.	.	.
------	------------	------	---	---	---	---

Preset 0 is a special 'autostore' preset which stores the current front-settings in preset 0 each time you recall a preset.

Note:

Most of the factory presets are made for stereo use (<PAN-MOD> is on). Just switch off <PAN-MOD> to use those in mono. Of course preset #92, AutoPan of direct signal only, has no effect then.

Most of the presets are also made to demonstrate some of the modulation effects rather than to demonstrate the numerous echo effect possibilities. The best echo effects are created with delaytime set to match the music in some way. The <LEARN> key helps to make this easy. Feedback is applied to generate the 'number of repeats' you want.

9.2 MODULATION FORMS CHARTS

The following charts look at the available parameters and the resulting effects associated with modulating Delaytime (DELAY), pan position (PAN) and the dynamic volumes (DYN).

DELAY MODULATION FORMS

SINE	Chorus and Flanger effects A very smooth sine control enables many pleasant chorus/flanger effects to be made, even on quite long delay settings. Some chorus examples can be found in factory presets #81, 84, 85 and 88, 89, some flanger effects (w.delay feedback) in #86, 91 and 99
SPEED DEPTH SPEC.#9:	controls sweep rate (in Hz) controls sweep width or depth selects direction of sweep at DLY ON or MOD ON : 0: sweep up, 1: sweep down.
RND	Chorus, Automatic Double Track the random waveform removes the periodic nature of sine. Set with random panning and a slight random DYN some very pleasant double track sounds can be produced. Some examples in factory presets #95 & 97
SPEED DEPTH SPEC.#9:	controls sweep rate (in Hz) controls sweep width or depth as with sine.
ENV	Pitch Shift, through threshold controlled ramp input above thresh: ramp starts producing pitchshift input below thresh: ramp returns for next pitchshift (no factory preset examples)
SPEED DEPTH SPEC.#9: #10:	controls pitch shift period. controls amount of pitch shift 0: pitch down, 1: pitch up. 1-9 : 9 thresholds (3 dB steps) for dlytime mod., 5=default.
TRIG	Triggered sine mod. for e.g synchronized Flanger sweeps input above thresh: sweep starts input below thresh: sweep stops (no factory preset examples)
SPEED DEPTH SPEC.#9: #10:	controls sweep rate, should be set quite high controls sweep width 0: sweep start direction = up, 1: start = down 1-9 : 9 thresholds (3 dB steps) for dlytime mod., 5=default.

PAN MODULATION FORMS

<p>SINE</p>	<p>Sine Stereo Panning (auto-panning) To create numerous panning effects on direct, delay or both signals in an opposite manner. When Speed is matched to the delaytime, echo repeats can be made appearing alternatingly in Left and Right side. Factory preset #93 is an example of direct signal pan.</p>
<p>SPEED DEPTH</p>	<p>controls pan sweep speed (in Hz) controls width of panning in the stereofield</p>
<p>RND</p>	<p>Random stereo Panning the random waveform removes the periodic nature of sine. You cannot tell in advance where the position will be. Also useful in small amounts of depth to create a slight 'wavering' in the position of signals. (presets #95 & 97) Factory preset #87 is an example of echo w. random pan.</p>
<p>SPEED DEPTH</p>	<p>controls average sweep rate (in Hz) controls width of panning in the stereofield</p>
<p>ENV</p>	<p>Envelope controlled Left-Right switching of Panposition. Each time input signal is paused (below PAN threshold) the pan position sweeps to the other side. Useful with a fast SPEED setting and rythmic music to create a 'left-right' switching pattern of the direct and echo signal parts. Factory preset #88,89 and 90 use the env. pan modulation.</p>
<p>SPEED DEPTH SPEC#.11:</p>	<p>controls pan sweep speed (in Hz) controls width of panning in the stereofield 1-9 : 9 thresholds (3 dB steps) for panpos. mod., 5=default.</p>
<p>TRIG</p>	<p>Trigged (gated) Sine Panning Trig pan to start when input signal is below PAN threshold, to create e.g. a 'moving tail' of echo repeats (w. feedback). By matching pan speed to delay time you can get e.g. repeat 1 at Left, repeat 2 at middle, repeat 3 at right. When you pause playing (input below thresh) sweep starts. Sweep stops when you start playing (input above thresh). (No factory preset examples)</p>
<p>SPEED DEPTH SPEC#.11:</p>	<p>controls pan sweep speed (in Hz) controls width of panning in the stereofield 1-9 : 9 thresholds (3 dB steps) for panpos. mod., 5=default.</p>

DYN MODULATION FORMS

SINE	<p>Sine Tremolo. Sine volume modulation effect on both direct and delay signals. Traditional tremolo effects and matching the tremolo speed to the rythm is effectfull.</p> <p>Opposite Tremolo (<REVERSE on>), direct and delay parts are modulated in an opposite direction so that when direct volume is up the delay volume is down.</p> <p>Factory presets #93 & 94 are examples of sine tremolo</p>
SPEED DEPTH	<p>controls tremolo modulation speed (in Hz)</p> <p>controls depth of tremolo modulation</p>
RND	<p>Random Tremolo. Random volume modulation effect on both direct and delay signals.</p> <p>Opposite Random Tremolo (<REVERSE> on>), direct and delay parts are modulated in an opposite manner.</p> <p>Factory preset #97 is an example for enhancing ADT effect</p>
SPEED DEPTH	<p>controls average sweep rate (in Hz)</p> <p>controls width of panning in the stereo field</p>
ENV	<p>Compressing/overcompressing of delaysignal to make dynamic delay effects. The falling input level turns up the volume of the delay signal. Rising input level turns down delay vol. With <DEPTH> above '25' the delay volume is 'overcompressed' creating more of a ducking effect.</p> <p>No factory preset examples of compressing/overcompressing.</p> <p>Expanding (<REVERSE> on). Raising input level turns up the delay and direct signal volumes, falling input turns volumes down. Making e.g.'soft attack' violin like sound from guitar.</p> <p>No factory preset examples of expanding/attack suppr.</p>
SPEED DEPTH SPEC.#12:	<p>controls compressor or expander 'turn up volume' time.</p> <p>controls compressor/expander slope, depth of suppression.</p> <p>1-9 : 9 thresholds (3 dB steps) for delay vol., 5=default.</p>
TRIG	<p>Ducking for suppression of echo while playing for improved, less 'muddy' echo effects with strong echo level/feedback. The delay volume and feedback is turned down when input signal is present (above threshold level).</p> <p>Some examples of applying dynamic delay ducking, can be found in presets #82, 83, 84, 88, 89, 90.</p> <p>Gating (<REVERSE> on). The 'reverse' of ducking'. The delay volume and feedback is turned down when input signal is below threshold. Good for adding echo to shifting or percussive music. The echo and feedback do not hang, but are quickly 'cleaned'. A single example in fac.pre. #87.</p>
SPEED DEPTH SPEC.#12: SPEC.#13:	<p>controls ducking/gating release time i.e. how fast 'ducking' stops, when input level stops and how fast 'gating' starts, when input level stops.</p> <p>controls ducking/gating depth of suppression.</p> <p>1-9 : 9 thresholds (3 dB steps) for delay volume. 5=def.</p> <p>1-9 : 9 thresholds (3 dB steps) for feedback suppr. 9=def.</p>

9.3 TC 2290 BLOCK SCHEMATICS

AUDIO SIGNAL PATH

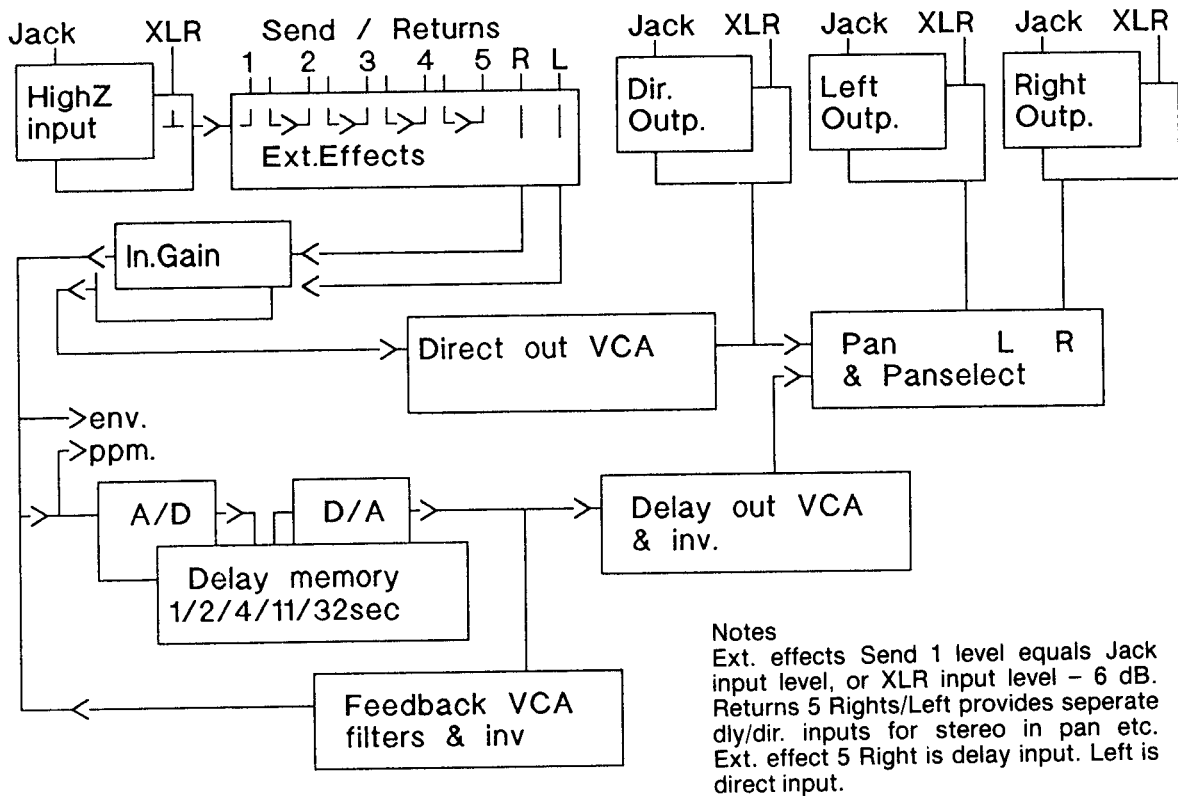

CONTROL HARDWARE

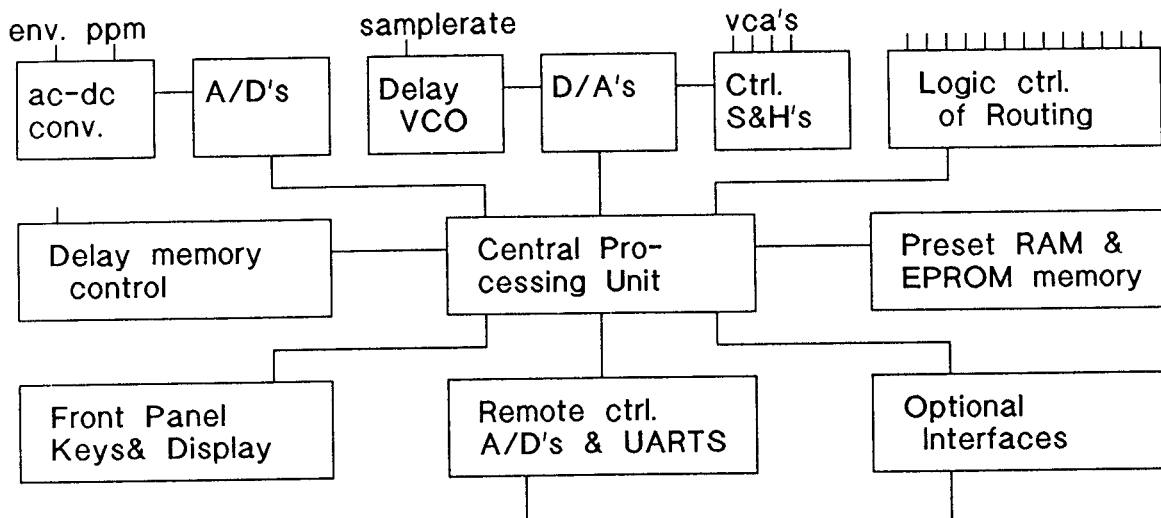

REMOTE INTERFACE CONNECTIONS

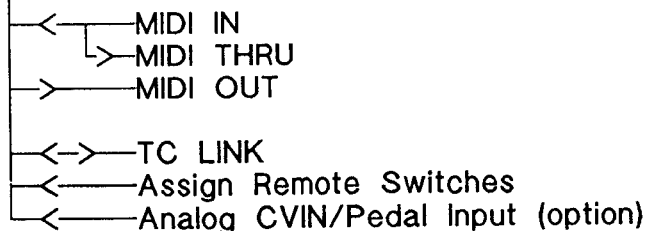

SOFTWARE GENERATED MODULATIONS

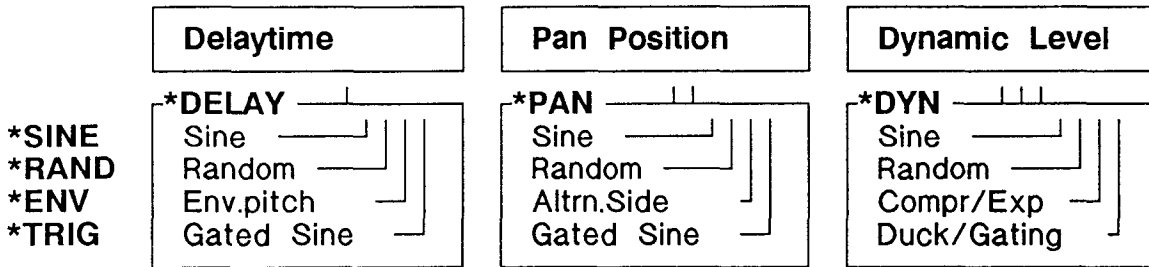

DYNAMIC MODULATIONS BLOCK SCHEMATICS (simplified)

SINE & RANDOM (Tremolo)

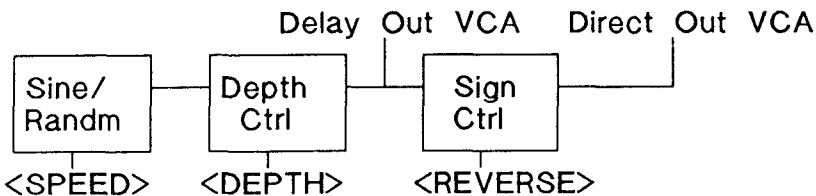

ENV (Compressing/Expanding)

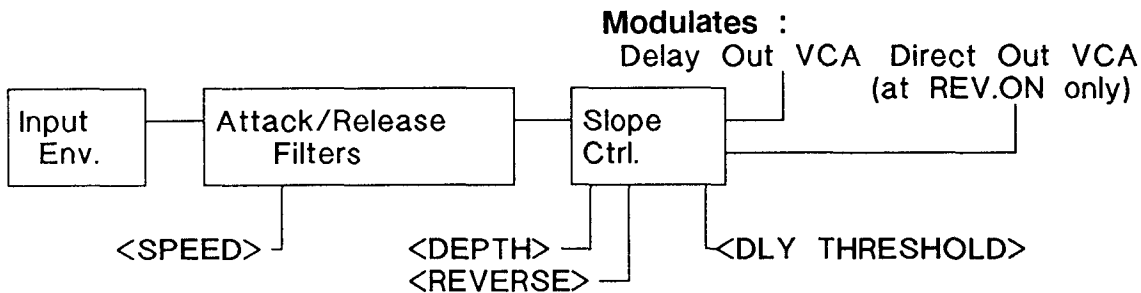

	┌ Compressing ─┐	┌ Expanding ─┐
REVERSE :	Off	On
SPEED :	Release time	Attack time
DEPTH :	Compressing	Expanding depth
	/overcompr. slope	

TRIG (Ducking/Gating)

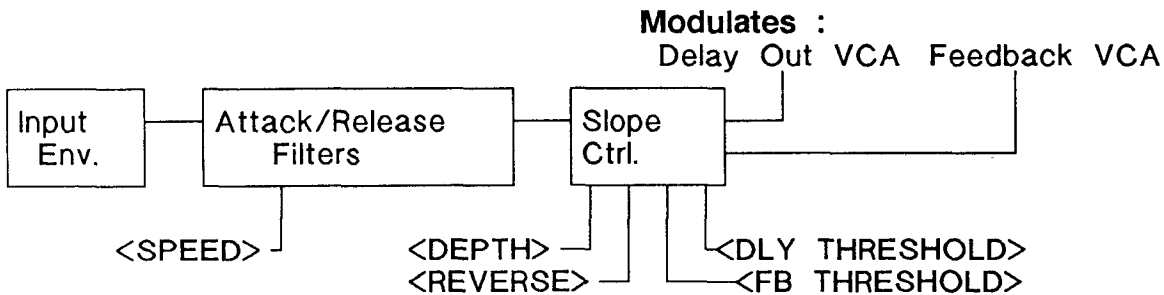

	┌ Ducking ─┐	┌ Gating ─┐
REVERSE :	Off	On
SPEED :	Release time	Release time
DEPTH :	Ducking depth	Gating depth

9.4 SPECIAL NUMBER LIST for prom ver.26.5

Spec No.	Min/max Value	Fac. Default	Preset/global	Name/Function
0	265	265	global	Prom Version No.
1	0-127	51	global	Midi Exclusive ID-No. - When sending midi exclusive codes (to another TC 2290 or to a computer), this number ensures that only equipment w. identical ID-Nos. are 'listening' to these exclusive codes.
2	0-1	1	global	Midi Exclusive Input Off. - '1' means that TC 2290 ignores input exclusive midi codes, (even if ID-no. is ok). With the value '0', TC 2290 responds to midi input exclusive codes.
3	0-1	1	global	Midi Exclusive Output Off. - '1' means that TC 2290 does not send out all keypressings as midi exclusive codes. With the value '0' all keypressings are send out as midi exclusive codes.
4	1-16	1	global	Midi Ch. - the frontpanel key <MIDI CH> actually selects this spec.#.
5	0-1	0	global	Midi Omni Off - '1' means that TC 2290 will only listen to the chosen MIDI channel #. At '0' TC 2290 listens on all midi channels.
6	0-1	0	global	Midi Enable , as the frontpanel key
7	1-32	1	global	Memory Size - here you write how many seconds delay, the TC 2290 has been fitted with. Take extreme care not to write a wrong value, or a very annoying and noisy 'hole' will appear in the sound if set too high !!
8	1-100	80	global	Preset Protect - all presets below this number are not protected against accidental store. Note: Preset #0 (the 'autostore' preset) cannot be protected.
9	0-1	0	preset	Inv. Dly.modulation. '1' to invert the flanger sweep start and env. pitchshift direction.

The next 4 spec.# set the thresholds associated with the modulation forms ENV and TRIG. The higher the value the higher input signal is nessecary to get the same modulation effect. Dly and Pan thresholds are from -48 to -24dB (ref 0dB PPM). Dyn thresholds -36 to -12dB. All in 3dB steps.

10	1-9	5	preset	Dly.Mod.Threshold , 9 thresholds for the Dly Env. and Trig waveforms.
11	1-9	5	preset	Pan Mod.Threshold . 9 thresholds for the Pan Env. and Trig waveforms.
12	1-9	5	preset	Dyn Dly.Vol Threshold . 9 thresholds for the Dyn Env. and Trig waveforms.
13	1-9	9	preset	Dyn Feedback Threshold . 9 thresholds for the Dyn Env. and Trig waveforms.

Spec No.	Min/max Value	Fac. Default	Preset/global	Name/Function
14	0-1	0	global	Manual Delay On Control ('1'=manual, '0'=in preset)
15	0-1	0	global	Manual Sample Control
16	0-1	0	global	Manual Outgain Control
17	0-1	0	global	Manual Dirgain Control
18	0-1	0	global	Manual Ext.Eff. Control
19	0-1	0	global	Keyboard Lock , '1' enables a double <ENTER><ENTER> on keyboard 'locks' keyb. to the parameter, preventing other <UP/DOWN> keys 'catching' keyboard. Pressing <.><.>, <PRESET>, <CHANGE> or <SPEC> will remove the lock.
20	0-1	0	global	Special Number Roll , for the user often programming spec.#.- Set to '1' to enable 'special number roll'. <SPEC> rolls forward one number, <ENTER> rolls forward to next spec.value. <DELAY UP/DOWN> cancels spec no.display.
21	0-255	0	global	SpecNo.Sys - for service only.
22	0	0	global	Show Keycode , to help when programming the assign keys. Selecting this results in the display of keycodes of all following keypressings. Note that the TC 2290 functions unaffected by this 'show keycode in delay display' so all keycodes for keys that result in a changed delay display can not be shown. These are :<DELAY UP>, <DELAY DOWN>, <SPEC>, <MIDI CH> and <LEARN>.
23	0	0	global	Last Error , Shows last occurred errorno. If you have had error. no.13 (=presets and spec.no overwritten by fac. defaults) a '0' must be entered here to tell the TC 2290 that you have seen the error. Check the Error #. List for other possible error nos.
24	0	0	global	Fatal Error . Show last-.(service only).
25	0-99	99	global	Direct Signal bypass volume . If Bypass Method (spec 26) is set to 'output mute' (val.1) or 'mute both' (val.2), this spec.no 25 decides the volume of the direct signal when delay is bypassed (w. the <DELAY ON> toggle key)
26	0,1,2	2	preset	Bypass Method , selects between 3 bypass methods: Input mute (0) for 'a tail of delay' or Output mute (1) for 'history, but no tail' or both (2) for 'no history, no tail' when bypassing.

Spec No.	Min/max Value	Fac. Default	Preset/ global	Name/ Function
37	0-9999	0	global	Reset - If you write '1' in this spec. no. the factory presets 80-99 are restored at the next power on/off sequence. Otherwise if the number '2290' is not the value of this spec. no., a total reset of the TC 2290 is performed at next power on/off. The reset includes all presets and special-nos. are set to the factory default values. Note that at the following power-up the error no. '13' is shown (presets lost) until you write '0' in the spec.no 23 to tell TC 2290 that you are aware that presets are lost.
38	1000-9999	1023	global	Max.Dlytime sets max delaytime when pressing <LEARN> - when sampling (repeat/hold) how long the repeating sample is. Turn off/on power before active.
40-48	0-199	31	global	Assign Key A String , default is <PRESET UP>. (See section for programming assign keys).
50-58	0-199	32	global	Assign Key B String , default is <PRESET DOWN>. (See section for programming assign keys).

The numbers 60-99 are used for four remote assign switches, as used with the TC 0050 Remote Switch Panel. You can also make remote switches yourself, see the 2290-apn.04 note 'How to make remote switches'.

60-68	0-199	85	global	Remote Assign Key 1 String , default is <DELAY ON>. (See section for programming assign keys).
70-78	0-199	36	global	Remote Assign Key 2 String , default is <LAST PRESET>. (See section for programming assign keys).
80-88	0-199	31	global	Remote Assign Key 3 String , default is <PRESET UP>. (See section for programming assign keys).
90-98	0-199	32	global	Remote Assign Key 4 String , default is <PRESET DOWN>. (See section for programming assign keys).

Note that if the special is 'in preset' it means that there are 100 values, one individual value for each preset. If the special no. is 'global' the parameter is common to all presets.

Calling a spec.no other than the above will result in error #1.

Attempts to enter 'out of range' spec. values will result in error #2.

(The spec.nos from 25 and up are new or changed as compared to lower EPROM version #)

9.5 ASSIGN KEYCODE LIST

Each key on the 2290 has a codenumber. To program the assign keys <KEY A> and <KEY B> and the four <REMOTE KEY>'s you need to know these code numbers.

IMAGEKEYS

Beyond the frontpanel keys there is a number of 'imagekeys' - keys that do not have a physical key on the frontpanel, but can be accessed with the programmable assign keys <KEY A>, <KEY B> and/or the <REMOTE KEY>'s.

As two examples of 'imagekeys' we have the <PRESET UP> and <LAST PRESET> keys.

PROGRAM <KEY A> TO BE A '<PRESET UP>' KEY:

```
<SPEC><4><0><ENTER> ; point at <KEY A> assign string beginning
    <3><1><ENTER> ; enter keycode for <PRESET UP> image key
<SPEC><4><1><ENTER> ; point at next <KEY A> string location
    <1><9><9><ENTER> ; enter the code for <END ASSIGN>
```

PROGRAM <KEY B> TO BE A '<LAST PRESET>' KEY:

```
<SPEC><6><0><ENTER> ; point at <KEY B> assignstring beginning
    <3><6><ENTER> ; enter keycode for <LAST PRESET> image key
<SPEC><6><1><ENTER> ; point at next <KEY B> string location
    <1><9><9><ENTER> ; enter the code for <END ASSIGN>
```

KEYNAME KEYNO. (Imagekeys denoted with '* *')

NUMERICAL KEYS GROUP

<0>	0
<1>	1
<2>	2
<3>	3
<4>	4
<5>	5
<6>	6
<7>	7
<8>	8
<9>	9
<.>	10
<ENTER>	11

PRESET KEY GROUP

<PRESET>	30	
<PRESET UP>	* 31 *	
<PRESET DOWN>	* 32 *	
<MIDI CH>	33	midi channel key
<STORE>	34	
<SPEC>	35	
<LAST PRESET>	* 36 *	recalls previous preset

UP/DOWN KEYS

<DELAY UP>	40
<DELAY DOWN>	41
<SPEED UP>	42
<SPEED DOWN>	43
<DEPTH UP>	44

	<DEPTH DOWN>	45	
	<OUTPUT UP>	46	
	<OUTPUT DOWN>	47	
	<FEEDBACK UP>	48	
	<FEEDBACK DOWN>	49	
ACCESS KEYS			
	<CHANGE>	60	
	<LEARN>	61	
TOGGLE KEYS:			
	<DLY MOD>	70	delay modulation toggle
	<PAN MOD>	73	pan modulation toggle
	<DYN MOD>	76	dyn modulation toggle
	<OUT INV.>	79	output delay invert toggle
	<FB INV.>	82	feedback inv. toggle
	<DLY ON>	85	delay on toggle
	<SAMPLE>	88	sample toggle
	<REVERSE>	91	dynamic reverse toggle
	<MIDI ENABLE>	94	midi enable toggle
ROLL KEYS			
	<SELECT>	100	modulation section roll key
		* 101 *	select dly mod parameters
		* 102 *	select pan mod parameters
		* 103 *	select dyn mod parameters
	<WAVEFORM>	110	waveform roll key
		* 111 *	sine
		* 112 *	random
		* 113 *	envelope
		* 114 *	trig
	<PAN MODE>	125	direct/delay pan roll key
		* 126 *	delay out of phase, no panning
		* 127 *	enable pan dly
		* 128 *	enable pan dir
		* 129 *	enable pan both, alternating
	<SELECT>	130	output section roll key
		* 131 *	select delay output volume
		* 132 *	select direct output volume
		* 133 *	select total output volume
		* 134 *	select pan position
	<SELECT>	140	feedback section roll key
		* 141 *	select feedback
		* 142 *	select high filter
		* 143 *	select low filter
ASSIGN KEYS GROUP			
	<KEY A>	150	
	<KEY B>	151	
	<REMOTE KEY 1>	152	(pull to gnd. through 8K2)
	<REMOTE KEY 2>	153	(pull to gnd. through 6K8)
	<REMOTE KEY 3>	154	(pull to gnd. through 5K6)
	<REMOTE KEY 4>	155	(pull to gnd. through 4K7)
	<KEY A LED ON>	* 160 *	
	<KEY A LED OFF>	* 161 *	
	<KEY B LED ON>	* 162 *	
	<KEY B LED OFF>	* 163 *	
	<END ASSIGN>	* 199 *	end of assign key-string code

9.6 TC 2290 TECHNICAL SPECIFICATIONS

DELAY PATH

Dynamic Range > 100 dB
Frequency Response 20-23000 Hz +/-0.5dB
Soft Roll Off -3dB at 25KHz,-12dB at 30KHz
Distortion < 0.05 % @ 1KHz, 0dB PPM
Conversion principle Dynamic Differential Conv., 1MHz samplerate

DIRECT PATH

Dynamic Range, Freq.Resp., Dist. : Better than above

DELAY TIME

std. 1023mS, sockets for up to 4 sec.,
options +4 to +28 seconds card.

PRESETS

User Presets 0-99, 1-79 user presets, preset 0 'autostore'
Factory Presets 20 (from 80-99, can be user changed &
recalled)
Presetable parameters all except common setup parameters, input
gain & power
Preset data retention > 10 years

MODULATION EFFECTS (software controlled)

Delaytime modulations with automatic depth correction by sine, random for
chorus, flanger, ADT, delay+chorus effects or input level envelope
triggered for periodically constant pitchshift and level gated chorus/flanger
sweeps.

Dynamic modulations of direct, delay and feedback levels in various
combinations by sine or random for tremolo effects or input level
dependant for compress, expand, duck and gating effects.

Panning modulations of direct, delay or both by sine, random, envelope
triggered sideshift or level gated panning.

Delaytime, dynamic and panning modulation can occur simultaneously.
Sampling, see separate description.

INPUT/OUTPUT JACK CONNECTIONS

High Z input instrument input, $Z_{in}=1M\Omega$
Input sensitivity +2 dBm to -22dBm for 0 dB PPM *1)
Headroom at 0 dB PPM 12 dB @ 1KHz

Left/Right/Direct Outputs:

Output Impedance 750 Ohm
Max. Output +16dBm

INPUT/OUTPUT XLR CONNECTIONS

XLR Input balanced, 20KOhm
Sensitivity +14dBm to -10dBm for 0 dB PPM *1)
Headroom at 0 dB PPM 12 dB @ 1KHz
Common Mode Rejection > 50 dB
Connection IEC std. (P1 gnd, P2 +phase, P3 -phase, if
using unbalancing cable, pin 3 must float .

Left/Right/Direct Outputs:

Output Impedances 100 Ohm bal, (non gnd. lift)
Max. Output +26dBm

Connection IEC std. (P1 gnd, P2 +phase, P3 -phase, if using unbalancing cable, pin 3 must float)

EXT.EFFECTS SECTION

Sends 1-5 Zout 100 Ohm, Outlevel equals Jack input level or XLR input level -6dB, max +16dBm output

Returns 1-5 Zin 220 KOhm, max +16dBm input

Logic Ctrl. Outputs Return 5L,5R stereo or direct/delay inputs. Located on the Send 1-5 stereojacks ring/gnd

Open collector pull down at ext.effect on, to control ext. logic inputs (ext.bypass, relays etc.). Drives ext. bypass, mute, start/stop, trig etc at normal +5 to +15VDC, max 25V open voltage, max pull down 25mA. Operates in parallel with Ext.Eff. Send/Ret.Loops.

REMOTE CONNECTIONS

MIDI IN/THRU/OUT std. DIN conn., passes preset shifts, total external control via excl.codes, 2290/2290 talk. Sample pitch, trig with Sampleoptions.

TC LINK bidirectional, std. jack/jack chord, for advanced remote control panels & communication. Data rate 31.25 KHz, common pull down line. NRZ encoding, foldback power output on pin 2 max. 400mA,+5VDC

ASSIGN SWITCH for up to 5 user programmable simple remote switches. Std. jack/jack cable, defaults to Learn/Trig input.

ANALOG PEDAL/CVIN For optional analog control by variable resistor pedal (0 to 50-100KOhms) or voltage input 0 to +5V from <1KOhm

GENERAL

Voltage Selections 100/120/220/240 VAC

Power Consumption 30 W

Fuse 5 x 20 mm, size printed on rear panel

Weight 5.7 kgs / 12.6 lbs.

Dimensions 482x89x242 mm (19x3.5x9.5 inches)

OPTIONS

Sample software (comes with min. 2 sec. delaytime)
4 to 32 sec. delay/samples memory options.
TC SERIAL REMOTE CONTROLLER, 14 switch footpanel with comprehensive display for on stage control.
(more on options & ordering numbers in sep. section on this.)

*1 Input sensitivity on models w. serial no. less than _____ has
Jack input sensitivity from +2dBm to -18dBm
XLR - - - +14dBm to -6dBm

10.0 Troubleshooting

What are you going to do if you do not succeed in getting sound from your TC 2290. Well you could take it to your local TC dealer, but what if you could quickly check if there was something wrong without dragging it away.

This little guide will help you check some of the 'common human mistakes'.

No Light in the Front Panel Displays

The front panel power switch in on?

Power mains cable is connected allright?

Check out if the mains connection is working – e.g. by trying something else to the same outlet.

If still no light, check the rearpanel fuse and voltage setting (see section [6.1]).

No Sound through the TC 2290:

Try connecting your instrument cable directly to your amplifier to check the amplifier, the instrument and the cable.

Connect then input to the TC 2290 (jack input in lower left corner).

Check that the input PPM meter flashes green, indicating input to the TC 2290. If no PPM indications try checking all external effects loops are turned off (EXT. EFFECTS section [5.12]).

Now recall a preset in which we know that the direct, delay and total output volumes have been set higher than '0' – e.g preset 80.

Check your output cable connection. E.g by trying another cable.

Direct Sound, but no Echo from the TC 2290

If you are using the DIRECT output, you will get no echo/ delay effects but only the direct signal, switch your output cable connection to the jack or XLR LEFT output.

If you are using ext. effects, try turning off those in the external effects section (to check if faults in the external effects and their connections).

Now recall a preset in which we know that the delay and total output volumes have been set higher than '0' – e.g. preset 80.

If you're in one of your own presets:

Check <DELAY ON>

Check <SAMPLE> off.

Check delay output volume [5.3] is well above the '0' setting.

Check common output volume

If mono operation, check if signal is panned to the output you are using, or better: Turn off all panning (in the PAN section none of the DIRECT/DELAY LEDs are lit).

If you still have no echo sound, but the TC 2290 seems to function (lights and control works), you can try as a last solution to 'reset' the TC 2290 by writing '0' in spec no. 37 : <SPEC> <3><7> <ENTER> <0> <ENTER> and then turn off/on power.
(for prom version less than 26.5 the sequence is <SPEC> <9><8> <ENTER> <0> <ENTER> and then turn off/on power, the EPROM version can be seen by pressing <SPEC><0><ENTER>).

Random Noise at High Volume

You might have set the spec no. 7 to a wrong value check [9.4]

Is it possible to have a simple footcontrolled Bypass?

Yes, if your EPROM is version is 26.5 or higher. Check the note 2290-apn.04 on 'how to make remote controls' [11].

Preset #0 seems to loose the Presets Settings I store

Yes, preset 0 is from PROM 26.5 an 'autostore' preset, automatically storing the current front-settings in preset 0 each time another preset is recalled.
If you have made some changes to a preset and forget to store these settings before recalling another preset, you can find the 'lost' settings in preset #0.

Input Gain makes Noise when turning

Some of the early TC 2290 make some noise, when turning the INPUT GAIN potentiometer. The problem is solved by cutting R527 located close to the INPUT GAIN potentiometer connections, check with you technician or your TC dealer to make this simple operation.

One of the XLR Outputs Distorts

If you are using an unbalancing cable connection make sure that pin 3 floats (not connected). Otherwise a clipping distortion at approx. 0 dBm output will occur. Also make sure not to feed the outputs with phantom power from the mixer. The TC 2290 outputs are DC connected in order to get better lowfrequency response, however feeding the outputs with phantom current causes the maximum output voltage to be limited as well as the output drivers will be heated unnecessarily. If you cannot avoid feeding the phantom, then ask your technician to install series capacitors in your cable connection or inside the TC 2290 (50uF, 60V, plus side towards the mixer)

Check the tech.spec. for cable connections.

A Single Preset Causes Malfunction

If you are in a very 'mains power noisy' environment a single preset or spec.no setting might have been blurred. Some equipment generates a lot of power-line-noise (home-made light control or the turning on/off heavy power amplifiers on long shared cables). Correct the power-line connections and store a 'well-behaved' preset into the preset that malfunctions.

Several Presets Cause Malfunction

You can do as with a single preset malfunction – however – it is more likely a more serious fault has occurred –

If you can access the special section then 'RESET 2290' with the key sequence: <SPEC><3><7><ENTER><0><ENTER> – then turn off power and on again.

The display should now show ERROR 13. Now do the sequence <SPEC><2><3><ENTER><0><ENTER> to tell you have seen the ERROR 13 (all preset and spec.no overwritten)

If the several presets malfunction occur again – turn in the 2290 to authorized service.

Error # 4 is shown when pressing the <STORE> key

Right – The frontsettings cannot be stored simply by pressing the <STORE> key. Error # 4 means 'Wrong Store Sequence'. The store sequence, must be preceded by a <PRESET> keypress: <PRESET> <number> <STORE>. (<number> can be omitted if you are 'updating' the current preset #. This 'extended store sequence' is to prevent you from accidentally 'updating' your presets.

Error # 13 is Shown at Every Power-Up

If you have written something else than '2290' in spec.no 37 a reset of TC 2290 will take place at next power on. The error # 13 indicates that a reset has occurred which means that you have lost all your presets and special no settings. – They have been overwritten by the factory default values.

(If you have written '1' in the spec.no 37 only the factory presets are restored).

To tell 2290 that you are aware of this, you must write in special no. 23, the value 0:

<SPEC><2><3><ENTER><0><ENTER>

On the next power up the error 13 will disappear.

If the ERROR 13 does not disappear or reappears on later power-ups there might be a fault in the back-up circuitry – in which case you should turn in your TC 2290 in for service.

Error # 20 is Shown Occasionally

Each time the TC 2290 is powered up it does a self check routine. If any faults are found they will be shown as an error no in the delaytime display.

The routine includes a check of the software PROM and the preset RAM contents.

If any such 'hardware' fault errors occur they are shown as error # 20. Further diagnose of the fault can be done by reading the contents of spec. 24 which normally reads '0', but takes a non-zero value when an error has been found. If it shows '3' the PROM has malfunctioned.

Although an error 20 has occurred you can continue using the TC 2290 (at your own risk), you can also stop the warning message '20' by writing '0' to the spec. # 24., however if it reappears we strongly advice you to send your TC 2290 in for service.

Error # indications:

Error#

1	Wrong special number
2	Wrong special value
3	Preset Protected
4	Wrong Store sequence see [5.9]
13	Indicates Reset has occurred (see [9], spec.no 37)
20	Indicates Fatal Error

Service

The TC 2290 contains no spare-parts or service instructions.
If the TC 2290 malfunctions please check the 'Troubleshooting' [10].

If you fail to find a proper solution there please send your TC 2290 in to your dealer, who ensure that the TC 2290 gets qualified service.

- 2290-apn.01 On TC 2290 Sound Quality
- 2290-apn.02 Using the External Effects Control
- 2290-apn.03 EPROM Exchange Procedure
- 2290-apn.04 How to make Remote Switches for the TC2290
- 2290-apn.05 Assign Key Applications
- 2290-apn.06 Switching Position of 2 External Effects
- 2290-apn.07 Controlling TC2290 from a Host Computer

General Notes:

- tc-apn.06 What is MIDI?
Including a view over MIDI history and some potential problems when using MIDI, Is MIDI always MIDI? – incl. a preset translation chart
 - tc-apn.07 On XLR connections, cables, balancing and unbalancing.
-

On TC2290 Sound Quality

TC2290 features a **1 Megahertz oversampling** frequency rate in the Analog to Digital as well as the Digital to Analog process, totally **eliminating** the need for frequency and phase distorting sharp rolloff filterings.

The dynamic difference A/D conversion process gives an equal or better than compact disc resolution for a crystal clear live sound quality as well as a totally trouble free performance transfer when recording for compact discs or high quality cut analog pressing.

The 100 dB and 20-23000Hz numbers are good as a measure of some basic qualities, but they certainly do not reveal all about quality.

Many delays feature 16 bit converters, which is the 'standard' for compact disc sound quality. A 16 bits resolution is certainly fine (giving some 90 dB dynamic range), but only part of the story. The difficulty lies in making the Analog to Digital conversion. A conversion which **is not at all in** a compact disc player (the disc only contains already digitized informations).

Whereas most Digital to Analog conversions in compact disc players are fitted with 'oversampling' to get sufficient quality, most digital audio equipment is not. This is due to the rather high cost of the 16 bit Analog to Digital conversion process made by oversampling!

As we see it, quality is **not** a limited bits linear converter giving heavily rising distortion as the delicate levels in music are reached. It is **not** a frequency response with very sharp filtering to compensate for an alarmingly **near audio** (sometimes even within!!) **sampling frequency**. (The filtering must be there to avoid a most unmusical 'mirroring' of all higher frequencies into the audioband). This sharp filtering cuts off very unnaturally and introduces some quite disturbing frequency and phase distortions.

The TC 2290 dynamic difference converter dynamically adjusts its resolution to low levels, high levels or whatever to obtain **a very high resolution of details**. Its beyond audio sampling rate of 1.000.000 Hz simply **eliminates** the need for sharp and disturbing filterings.

Using the External Effects Control

TC 2290 features the EXTERNAL EFFECTS CONTROL in two ways, either as a loop (SEND/RETURN) or as a logic control (EX.BYPASS).

USING EXT. EFFECTS LOOP (SEND/RETURN) CONTROL

Connect your pedals and rack mount effects in the following manner:

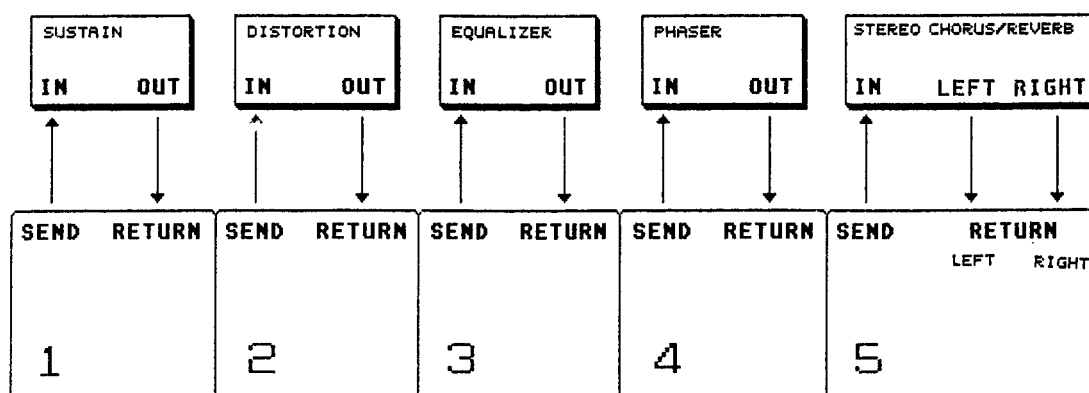

Note that the external effects themselves must be 'on'.

RETURN 5 is a stereo return enabling e.g a stereo chorus/flanger to be connected here.

If you have no stereo effect then use RETURN L only.

The EXTERNAL EFFECTS are connected in series. The effects are bypassed internally in the 2290, so that the quality of the signal is not reduced by external effects that are not switched on.

2 instruments may be mixed by using the returns of external effect 5, but this shuts out the possibility to use the normal input jack and external effects 1-4.

More about external effect 5 (stereo input)

The external effect 5 return Left becomes the »direct input« and the external effect 5 Right becomes the input to the »delay«. – It is thus only possible to delay the Right input.

If you want to pass the external effect L & R inputs in stereo to the outputs L & R, you must set equal output volumes on direct and delay signals (in the output section), and delaytime to »0«, and pan the direct and delay signal to opposite sides.

E.g.

<PRESET> <8> <0> <ENTER>; Recalls preset 80. <CHANGE> <5>; switches external effect 5 on. <DELAY UP> <0> <ENTER>; no delay. Now press <DELAY/DIRECT> in the PAN section until both LEDs are lit. If you want to »rotate« the L & R channels press in OUTPUT section <SELECT> until PAN LED is lit follow by <DOWN> until value is »0«. In this way you can hear when channels »rotate«.

Assign key applications

The main purpose of the assign keys is to create new performance possibilities, by way of 'pressing several keys' for you, when you press a **single** assign key.

Some extra keys (which are **not** on the front of the TC 2290) can also be made accessible.

There are numerous examples of what can be achieved by pressing several keys. The assign keys can be applied to making life easier for you when setting up sounds as well help make live performance easier.

You have 2 assign keys on the front panel of the TC 2290, and up to 4 remote panel assign switches. Each key can do up to 9 key pressings for you.

Some performance examples:

Any 'string of sound setting key pressings' that you cannot possibly remember or do not have time to make in a live situation.

Examples:

'a key' setting feedback level at 30 and another setting feedback at 0.

'a key' turning up common volume 3dB at each pressing, another turning 3 dB down.

'a key' setting panposition to the left side another key to the right side.

'a key alternating between two presets'

Say you want to alternate between preset 17 and preset 99: Recall preset 17, then recall preset 99. Now assign a key set to perform <LAST PRESET> will switch between those two presets each time it is pressed.

'using <PRESET UP> <PRESET DOWN> with organized preset sounds'

With preset sounds needed for performing organized in successive preset numbers will allow you to use the <PRESET UP> (and <PRESET DOWN> to 'regret') to step between the sounds in a simple manner.

Some 'making life easy' examples are:

Using the assign keys to make equal changes to many presets for you, or merely to make often used keypressings for you are examples of how life can be made easier for you.

An often used special number:

If you want to change a specific special number often (say 12, the Dyn Threshold), then make this a 'single key' pressing by programming one of the assign keys to do the <SPEC> <1> <2> <ENTER> for you.

An 'extended' example

is changing all presets to input bypass (setting spec.no.26 to '0') to produce a nice 'tail' of echo **after** you have pressed the <DELAY ON> to bypass.

If you plan to change all presets by manually going into every 100 presets, and changing the spec.26 value to '0' this would call for quite a number of keypressings!

<SPEC><2><6><ENTER><0><ENTER> <PRESET><STORE> <number><ENTER> repeated 100 times to change all presets!

We can try making this a bit easier by programming the assign key to help change bypass method in all presets:

We want e.g <KEY A> to do the sequence:

Set 'bypass method' to input, (=set spec.no.26 to '0')

store this change and then jump to next preset (Using the <PRESET DOWN> key).

Assigning the keysequence

<SPEC><2><6><ENTER><0><ENTER> <PRESET><STORE> <PRESET DOWN>

to <KEY A> is done by the sequence:

	Keynumber	To make <KEY A> press:
<SPEC><4><0>	<ENTER> <3><5>	<ENTER> ;<SPEC>
<SPEC><4><1>	<ENTER> <2>	<ENTER> ;<2>
<SPEC><4><2>	<ENTER> <6>	<ENTER> ;<6>
<SPEC><4><3>	<ENTER> <1><1>	<ENTER> ;<ENTER>
<SPEC><4><4>	<ENTER> <0>	<ENTER> ;<0>
<SPEC><4><5>	<ENTER> <1><1>	<ENTER> ;<ENTER>
<SPEC><4><6>	<ENTER> <3><0>	<ENTER> ;<PRESET>
<SPEC><4><7>	<ENTER> <3><4>	<ENTER> ;<STORE>
<SPEC><4><8>	<ENTER> <3><2>	<ENTER> ;<PRESET DOWN>

Now, starting from preset 99, each time <KEY A> is pressed the preset bypass method is changed and stored, and a jump to the next preset is made.

Please note that the factory presets 80-99 are store protected, this means that you'll have to 'open' first by setting <SPEC><8><ENTER><1><0><0><ENTER>. After you have changed the factory presets you can store-protect the factory presets again by pressing <SPEC><8><ENTER><8><0><ENTER>.

We can make the above assign key programming even easier by using the 'special number roll' function.

Press: <SPEC> <2> <0> <ENTER> <1> <ENTER>. The above example of programming <KEY A> is now done by the sequence:

	Keynumber	To make <KEY A> press:
<SPEC><4><0>	<ENTER> <3><5>	<ENTER> ;<SPEC>

; so we started off as above, but now
 ; we can 'roll' to the successive spec.no
 ; values just by pressing <ENTER>:

<ENTER> <2>	<ENTER> ; <2>
<ENTER> <6>	<ENTER> ; <6>
<ENTER> <1><1>	<ENTER> ; <ENTER>
<ENTER> <0>	<ENTER> ; <0>
<ENTER> <1><1>	<ENTER> ; <ENTER>
<ENTER> <3><0>	<ENTER> ; <PRESET>
<ENTER> <3><4>	<ENTER> ; <STORE>
<ENTER> <3><2>	<ENTER> ; <PRESET DOWN>

Now to 'exit' spec. roll press <> or <DELAY UP> once.

To check which keys <ASSIGN KEY A> is programmed for:

<SPEC><4><0><ENTER> ; shows value of first keycode
 <ENTER> ; shows value of next keycode (spec.no.41)
 <ENTER> ; shows value of next keycode (spec.no.42)
 <ENTER> ; etc.

To remove 'spec. number roll' press: <SPEC> <2> <0> <ENTER> <0> <ENTER>.

Show keycode:

To help when programming the **<ASSIGN KEYS>** this function displays the keycode number of the last key pressed:

EXAMPLES:

<SPEC><2><2><ENTER> ; (shows '11', as the last key pressed was **<ENTER>**)

now pressing:

<DYN.MOD>

<PAN.MOD>

shows:

; '76', the keycode for **<DYN.MOD>**

; '73', the keycode for **<PAN.MOD>**

or:

<PRESET>

<0>

<STORE>

.. etc.

will show:

; '30', the keycode for **<PRESET>**

; '0', the keycode for **<0>**

; '34', the keycode for **<STORE>**

Please note that the 2290 **functions normally**, even when this 'display keycode' is enabled. This means that activating any key that results in the delay display being used cannot be shown (Keys like **<DELAY UP>**, **<DELAY DOWN>**, **<SPEC>**, **<MIDI CH>**). For these as well as of course the imagekeys, refer to the appendix sec. [9.5] Keycode List.

Changing position of 2 external effects

A note on how to connect cables, and a suggestion on how to make assign <KEY A> switch effect B to come before A and vice versa.

With <KEY A> you can switch effect effect B to come before A

_____ Effect B _____ Effect A _____

and back at next <KEY A> press

_____ Effect A _____ Effect B _____

To enable the repositioning of two effects so that effect B is before effect A and vice versa, start by connecting EFFECT A to SEND/RETURN 2 and EFFECT B to SEND/RETURN 4:



Then, cross-connect the unused SEND/RETURNS with another three jack cables:

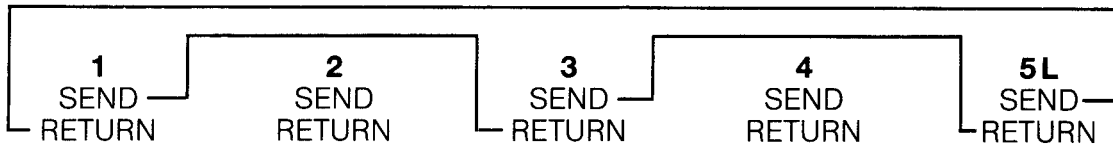

Repositioning EFFECT B before EFFECT A is now done by switching EXT.EFFECTS 1 **and** 3 **and** 5 on. (<CHANGE> <1> <3> <5>)
The total combinations are as follows:

	Bypass	A only	B only	A then B	B then A
EXT.EFF. 1				off	on
EXT.EFF. 2	off	on	off	on	on
EXT.EFF. 3		off	on	off	on
EXT.EFF. 4	off	off	on	on	on
EXT.EFF. 5				off	on

Other combinations are redundant (do not give extra possibilities).

To understand **why** this is so, show this piece of paper and the BLOCK SCHEMATIC to your technician and give 15 minutes to find out. If he cannot, -then consider getting another technician for your band.

to program KEY A for positioning effect B before A and vice versa:

```

<SPEC> <4> <0> <ENTER> ; start of <ASSIGN KEY A>
<6> <0> <ENTER> ; <CHANGE>
<SPEC> <4> <1> <ENTER>
<1> <ENTER> ; toggle ext. effect switch 1
<SPEC> <4> <2> <ENTER>
<3> <ENTER> ; toggle ext.effect switch 3
<SPEC> <4> <3> <ENTER>
<5> <ENTER> ; toggle ext.effect switch 5
<SPEC> <4> <4> <ENTER>
<1> <0> <ENTER> ; <> cancels keyboard on EXT.EFFECTS
<SPEC> <4> <5> <ENTER>
<1> <9> <9> <ENTER> ; end of <ASSIGN KEY A> string

```

What is MIDI

The intentions with this note are not to give a full description of the MIDI specifications and uses, but to brief its applications and problems only. For the user interested in an in depth treatment of its specifications and uses, several excellent articles exist. Some of them are listed in the appendix to this note.

MIDI History

With an ever increasing imaginativeness in the use of electronics, an electronics interface between musical instruments and accessories was bound to arise.

In the end of 1982 several manufacturers of musical instruments agreed upon a common standard for 'talk' between the equipment.

The Musical Instrument Digital Interface.

One of the main intentions of the MIDI system was to allow several instruments to be played from one, making life easier for the multi-keyboardist.

In the pre MIDI days this could only be done using specialized, expensive equipment.

MIDI has become a universal standard and has provided a multitude of possibilities for the performing musician as well as for the recording studio.

The applications for MIDI have exceeded the expectations of many. With MIDI it is possible to link together not only electronic music instruments and rhythm machines but also sequencers, midi controllable effects, as well as computers, pitch to midi converters and more to come.

MIDI, a Control Link

MIDI is a **control messages** link, **no sound passes through the cables.** (The data rate is simply too slow to carry audiosignals, 31125 bits per sec – while a high quality sound needs about 1 million bits per sec.)

The MIDI connections are 'one-way' or uni-directional, i.e. the control signals passes **only** in one direction in a connection cord. However it is possible to make bidirectional controls if two cables are used (and of course both MIDI IN and OUTPUTs are available).

Inputs, Outputs & Thrus

A MIDI connection is always made from an output to an input. For the purpose of having more inputs connected to the same output, an output can also be a THRU socket, which is provided on many units. The THRU socket delivers nothing but a copy of what is put to the INPUT no matter how you set any MIDI control parameters on the device.

The OUTPUT-INPUT, THRU-INPUT, THRU-INPUT connections can be continued endlessly. (However, there is a slight delay added for each extra THRU connection, see MIDI delays).

The Cables & Connections

The standard cable for connecting MIDI inputs and outputs is a DIN to DIN cable. Only the pins 4, 5 and shield need to be wired. See fig.

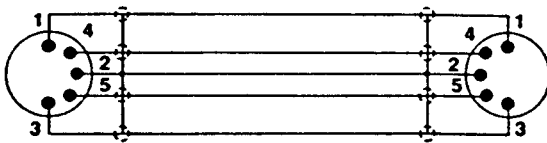

The length of the cable should not exceed 15 meters.

MIDI Messages

Numerous control signals can be 'communicated' through MIDI, some examples of these are when you press e.g the middle C note on a keyboard, codes for 'note # middle C on' are sent, when the same note is released, codes for 'note # middle C off' are sent. Similarly codes for how hard you stroke the key, pitch bend and much more can be sent.

All these MIDI codes are called 'messages'.

One of the MIDI messages of greatest interest with the TC 2290 is the MIDI preset or program change. Each time a change to another preset or program on the keyboard or the TC 2290 is done, the preset number is sent out on the MIDI OUT as well.

So through a pair of MIDI cables a keyboardist can make preset changes on the keyboard as well as the TC 2290 just by changing preset on one of them.

MIDI Channels

The MIDI messages has been organized so that an 'address' can be put on a message – who is the receiver of the message. This feature is called MIDI channels. There are 16 channels (addresses). With the channel feature larger MIDI systems can be set up using the channel feature to direct preset shifts and e.g. the keyboard activities toward specific 'expanders' and so on. The TC 2290 can e.g be set to respond only to preset shifts from a certain keyboard.

The channel feature can be turned off so that the addresses simply are ignored. This is called the MIDI OMNI ON mode.

With OMNI ON it is like playing back a sixteen track recording on a single (full) track machine – all tracks will be heard, so it does not matter that the preset shift message is only on e.g channel 7. OMNI OFF is like listening to only one track, decided by the MIDI CHANNEL number.

On some keyboards the OMNI on or off cannot be set without a decision about something called POLY/MONO as well. Normally POLY is then chosen.

MODE	RECIEVE
1	OMNI ON POLY
2	OMNI ON MONO
3	OMNI OFF POLY
4	OMNI OFF MONO

The MONO is for multi voice types of keyboards/synthesizers with facilities for setting independently each of the voices.

With the TC 2290 only the OMNI on/off can be set.

MIDI Delays

Chaining MIDI connections (using the THRU) adds a slight delay for each extra THRU connection. This puts a practical limit to the number of devices which can be controlled from the 'master' output. A 'split-box' (a box with one input and 3-6 thrus) does not help very much in reducing the slight THRU delays, except when equal receiving equipment is used (like several synths from one master).

The most serious delays in the MIDI system are that each MIDI message from the controlling MIDI output comes one after another, thus introducing delays between the sent messages.

As examples of absolute minimum delays:

To send a preset (program) change takes 0.64 mS, to send a note on or off takes 1 mS. To send 6 notes on takes 6 mS.

The only effectitive solution here is to reduce 'the midi traffic' on the MIDI line by using a more powerful MIDI master with several concurrent outputs.

Also the connected MIDI equipment takes som time to respond to MIDI messages. This figure differs very much from equipment to equipment. Typical 'respond-times' are in the range 2-20 mS.

At about 10 mS delays the controlled events (notes played, sample triggered playback etc.) start making audible 'hanging'.

The MIDI Standard now and in Future

Setting standards is often a troublesome matter, those of you who have computers must know about this.

Even with such a simple matter as the XLR 'standard' connection the problem exists. Although there is an 'agreed standard', the pin 2/3 connections are often interchanged.

With complex protocols ('the way in which the codes are sent/received and interpreted') like MIDI, making a standard is even more troublesome.

The manufacturer's problem is that he doesn't know what standard you need until sufficient experience has been achieved with 'the standard' – an impossibility. The consequence is often that many different implementations are marketed until a preference or the amount of equipment with a particular implementation is dominating, then this becomes the standard.

MIDI is in such a development.

As a result it is important for the customer that the product is equipped to be **software** updateable as the standards 'settle'. TC 2290 is.

MIDI has come to stay, but sure there is more to it...

the speed, the missing absolute timecodes (like SMPTE) etc. etc.

New interfaces will evolve...

It is important that the product is equipped to be **hardware** updateable as new interfaces evolve. TC 2290 is.

For Further Information about MIDI

Quite a number of publications about MIDI exist (and more are to come)

Some of the best are:

MIDI for Musicians, by Craig Anterton. (1986) Amsco Publications, New York. This publication takes you in non-technical terms from the basics to some extensive applications.

KEYBOARD MAGAZINE, 1986, January. A special issue on MIDI with a large number of articles about specific uses as well.

In Germany Fachblatt Musik Magazin has made a number of articles on MIDI starting from feb.84.

For the technically minded there is the MIDI Detailed Specifications, which can be obtained from: International MIDI Association, 11857 Hartsook Str., North Hollywood. CA 91607. USA.

12.0 Glossary

ADT. Automatic Double Track. Effect making a 'live' simulation of the typical dubbing process in the recording studio. Dubbing is sound-on-sound recording twice or more the 'same' playing or singing.

Assign. On the TC 2290 you can assign functions to a number of 'assign keys' i.e 'program' assignable keys to do a number of keypressings for you.

Attack, (see also envelope). On the TC 2290 attack expresses the fade-in time that elapses between 'threshold has been exceeded' to the time of maximum effect. Using SPEED, 10Hz expresses a time of 1/10 second, 1 Hz equals 1 second and 0.10 Hz expresses 10 seconds.

Auto-Panner. An electronic device capable of panning a signal automatically in a number of ways. The TC 2290 is able to function as an auto-panner.

Balanced. Apart from tonal and stereo position balance the term refers to an interconnection method. The advantages of using balanced connections are to minimize cable hum and noise pickup as well as to prevent differences in signal ground levels from being added to the audio-signal. A balanced input actually has two inputs (+ and -), the purpose of which is to be able to pick up the signal at the source, ignoring the 'surroundings', something similar to close miking compared to a more distant miking. Technically this is done by the letting the input(s) sense only differences between the two inputs, meaning that 'common' (hum etc.) signals present at both inputs are ignored or 'balanced' out. The audio signal, which is present as a difference between the two inputs, is passed. See also XLR.

Bypass. If an effects unit is in Bypass Mode it leads ('bypasses') the input signal unprocessed to the output(s).

Chorus. When a delayed and slightly modulated version of a signal is mixed with the original signal, then the sounds will seem 'larger', as if there were more (a chorus) from the same sound source. The effect can be enhanced with the original and the delayed signals panned in a composite way.

Compressing. To compress a signal means to change the dynamics so that the level is of a more 'constant' volume, than it is without the compressing, - low levels are raised in volume, higher levels are 'compressed'. It occurs when the DYN ENV modulation is selected.

dB. What is a dB?

dB is short for deci Bell, deci means 1/10 and Bell is the (now famous) guy, who suggested this logarithmic way of expressing a ratio.

When dBs are applied to our experience of levels of audiosignals **equal dB changes** e.g. +6dB and -6dB **give equal** experience of difference. Which is very practical.

This is opposed to expressing change in volts-change, adding 1V to level makes quite a difference being it from 0.1V to 1.1 V (= +21dB) or from 1V to 2V (= +6dB)

Ratio	
1	= 0 dB
10	= 20 dB
100	= 40 dB
1000	= 60 dB
10000	= 80 dB
100000	= 100 dB

Ratio	
1.12	= 1 dB barely noticeable
1.26	= 2 dB
1.41	= 3 dB clearly noticeable
2	= 6 dB
3.16	= 10 dB double volume
5	= 14 dB

each +/- 10dB doubles/halves experienced volume

If you raise signal level approx. 10 dB you will double the experienced volume. But the voltage signal level is raised 3.16 times (and the power needed from your amp rises volts squared = 10 times!)

Note that with dB we chose to make the reference without saying **anything** about absolute levels!

E.g. a ratio of 10 V to 1 V is 20 dB as is a ratio of 1000 mV to 100 mV.

A voltage ratio expressed in dB = 20 times the logarithm of the ratio.

dBm, method of expressing the absolute level of a signal. As opposed to dB where any level can be the OdB reference, the dBm has but one OdB reference and thus is an absolute measure. Measured in volts the OdBm is 0.775 Volts RMS.

The added 'm' is short for 'the voltage over a resistor of 600 Ohms which results in a power dissipation of 1 milliwatt. 600 Ohms is the typical impedance of a telephone line (does this ring a 'Bell'), and since then, has been adapted as level reference for much equipment dealing with audiosignals.

dBV or dBu, method of expressing the absolute level of a signal. OdBV is 1 V RMS. (Difference between dBV and dBm is 2.2dB so that e.g a level of 12,2dBm = 10dBV). Often used by audio manufacturers who recognize that their equipment is not necessarily connected to a telephone line. +4dBV is 'the standard' studio signal level (= 1.58V = +6.2dBm).

Default. A term from the computerage we're entering. Simply expressed a 'default' parameter value is the parameter value if you do nothing to change the value or if you do not suggest a valid value when changing. The TC 2290 contains a lot of variable parameters, if you do nothing to change the parameter values, these parameters do not have random values, but very specific 'default' values. Thus the sense here is 'initial' value. If you recall a preset using the <PRESET><number><ENTER> key sequence, but omit the <number>, the number then 'defaults' to the current preset number.

Delay. This is what most of the TC 2290 is about. By delaying the original signal in some way or another and mixing the delayed and the direct signal together numerous effects are possible.

Delay is an essential part of all echo, chorus, sampling, reverb and related effects.

»Got it? Or not _____ until a little delay passed?

Ducking. Ducking is the result of the **raising** level of one signal **turning down** the level of another. A typical 'ducking' situation is when a disc-jockey puts his 'voice over' the music. The TC2290 Ducking is the essential dynamic modulation controlling the echo level with the level of your playing. It occurs when the DYN TRIG modulation is selected.

DYN. Dynamic control of the output volumes of the TC 2290 by means of e.g your playing.

Dynamic – something we all would like to be. In the TC 2290 the analog to digital conversion principle is of a 'dynamic difference converter' instead of the usual 'absolute level' type. This is one of the 'secrets' of the high delay sound quality of the TC 2290.

Dynamic Range, the 'distance' in dB from the level of noise to the level of clipping. Dynamic Range is thus a universal figure which cannot be misinterpreted as easy as Signal/Noise Ratio. S/N figures can be manipulated by the manufacturer if the headroom is not mentioned or if headroom very unrealistically is set to 0.

Examples: With 100dB dynamic range and 12 dB headroom the S/N ratio is 100-12 = 88 dB. With 80dB dynamic range and 0 headroom the S/N ratio is 80-0 = 80 dB (– and a »pleasant« distortion on every peak!).

Effects Send/Return Loop. TC 2290 has 5 send/return loops. Such a send/return loop jack set is a 'selectable insert' send/return point similar to an insert point on a mixer channel. On the TC 2290, however, you can choose to accept or ignore the 'inserted' effect (using the frontpanel ext. effects on/off control). Together, the 5 SEND/RETURN loops form a 'series connection' of the effects.

To connect signals 'in series' are just like you would connect the effects if they were put before the TC 2290, i.e from your instrument to effect 1 from effect 1 to effect 2 etc. The delay, panning etc. effects of the TC 2290 itself ends this series connection of effects i.e the TC 2290 is the 6th. 'effect' in this 'series connection' of effects.

The RETURN inputs can be used for source (instrument) selection as well.

Enter a key to terminate or enter a command on a computer or TC 2290.

Envelope, a cover, usually made of paper, which many people wrap around their letters and put in boxes found all over the country.

In audio terms, the envelope of an audio signal expresses the volume (= the rectified and averaged level) of the audiosignal, as seen over a period of time. If you plot the TC 2290 PPM level meter values as a function of time, you would be making an envelope curve of the input signal.

On a synthesizer, pressing a key starts envelopes controlling volume, of – and filterfunctions applied to, a played note. These envelopes are functions of time. The envelope-curve is usually said to be composed of attack, decay, sustain, release time-parts.

When you 'attack' the key on the synth (poor keyboard), a little fade-in time elapses before volume reaches maximum. This time is called the attack-time. Similarly when the key is released a fade-out time passes before you have 'peace', this is the release time. In between the attack and release time-parts an initial release (decay) and the time you keep pressing the key (sustain) can be put.

The similarities to the TC 2290 envelope generations are:

TC 2290	KEYBOARD
input level above threshold	pressing a key,
how much above threshold	how hard you stroke the key
input level below threshold	releasing the key

Expanding. The opposite of compressing. Low levels become even lower, higher levels even higher. Happens when the DYN ENV REVERSE modulation is selected.

Feedback. When the output of an audio device is **feed** to it's own input, you have created a 'feedback (system)'. Acoustic feedback is well known as being quite difficult to control. Other feedback systems are very well controllable. E.g. feeding back the delay output back to the delay input to get more echo repeats or for creating a flanger effect.

Flanger. Originally flanging was a tape effect where you 'flanged' the tape reel with your finger so that the tape would run a little irregularly. When this irregularly pitchshifted signal was mixed with the original signal, a 'moving' effect resulted. This tape manipulation has been electronically refined in the so-called 'Flangers', which delay and modulate the original signal, to make similar and, much improved 'flanging' effects. The TC 2290 is capable of some very sophisticated flanging possibilities.

Gating. Gating is in function similar to ducking, except that the **raising** level of one signal **turns up** the volume of another. This happens when the TC 2290 DYN TRIG REVERSE modulation is selected.

Global. The individual preset delaytime setting is individual to each preset. The sun 'globally' shines on all of us, the input gain setting, the power on/off, the MIDI keys and many of the specialnumber settings work 'globally' (common) to all presets.

Headroom – The 'distance' in dB from nominal signal level to clipping level. Thus the figure expresses how much room there is for peaks in the music.

Signal to Noise ratio plus Headroom = Dynamic Range. At the 0 dB PPM indication of the TC 2290 approximately 12 dB headroom is available – unlike a lot of equipment which clip at this indication.

Hz. Good old Mr. Hertz suggested that any repetitive event could be expressed in events or cycles per second. Although people never began telling each other their heart beat rate in Hz and boys didn't ask their girls for '2 Hz sessions', it was and is practical to express e.g. audible tones in Hz. The low E string on a guitar moves e.g. in 80 Hz, the second harmonic of this is at 160Hz (one octave above) the third harmonic is at 240Hz (producing a 'B') etc. If we hadn't had good old Mr. Hz, technicians today we would still have to say that youngsters can hear from one cycle every 1/20 second to about one cycle every 1/20000 second.

Impedance, all inputs and outputs have an impedance. This impedance expresses for an output 'the sensitivity to hum and noise pick-up and cable loading'. Whereas an input impedance expresses how much the input loads the signal-source.

To approach the ideal working conditions, the output impedance figure must be as **low** as possible, whereas the input impedance should be as **high** as possible if the signal-source is sensitive to loading (a guitar pick-up is quite sensitive to loading effects.)

All impedances are measured in Ohms (see Ohm).

Intensity. Often used to describe the 'amount of added effect' to the dry (original) signal. Intensity is often used in conjunction with flanger and chorus effects. With echo effects intensity is normally described as 'repeats' as it determines the number of echo repeats. The word intensity is also used to describe the depth of modulation. Another term for this is DEPTH, which is used on the TC 2290.

Jack, normal guitar/keyboard signal plug/socket.

KOhm, KiloOhms = 1000 Ohms, see Ohm.

KHz, KiloHertz = 1000 Hz, see Hz.

LED (Light Emitting Diode) the only sort of 'lamps' used on 2290. Even the numeric displays are constructed from LEDs. LEDs are easy to see in daylight as well as in the dark. Also they are extremely reliable.

LFO, Low Frequency Oscillator. A generator that produces periodical voltages in certain waveforms (sine, random etc.) The repeat rate (= frequency, see Hz) can be changed and the voltage output can be used for modulating various (see) parameters. In Synthesizers pitch, timbre and amplitude can be modulated. In the TC 2290 you can modulate the delay time, the dynamic output and the panning with LFOs.

LFO SPEED. The frequency by which the LFO repeats its periodical waveforms. (see Hz).

LFO DEPTH. The output voltage amplitude of the LFO. Controls 'how deep' the modulation will be.

Microprocessor. A device ('chip') that is able to process multiple digital inputs to control, in more or less 'intelligent' ways, a number of outputs. The 'intelligence' depends on the 'software' instructing the processor, whereas the speed by which the control can be performed is determined by the chip. You will find processors in many fields. Every computer is built around a processor, as is TC 2290.

MIDI, abbreviation for Musical Instrument Digital Interface. A common standard for communication between the microprocessors of electronic musical instruments and/or effects units.

Mode, way of operation.

Modulation on the TC 2290, expresses some automatic alteration of one or more parameters.

The parameters that can be modulated are the:

1. PAN, pan position (of direct, delay or both signals),
2. DYN, volumes (of direct, delay or feedback), to make dynamic effects like tremolo, compression, expansion ducking and gating.
3. DLY, delaytime (to make chorus, flange and pitch shift effects).

Each of those parameters has their own set of 'automatic' sources (WAVEFORMS): These are:

1. A sine LFO generator,
2. A random LFO generator,
3. An envelope proportional extraction of the input signal level.
4. A trig, 'below/above' threshold controlled waveform.

MOhm, MegaOhms = 1.000.000 Ohms, see Ohm.

Ohm – All kinds of impedances are measured in Ohms. Mr. Ohm (another of the old guys) made a law which all electrical and electronic engineers have to obey.

Mr. Ohm was the first to discover that a current of 1 Ampere (Mr.-) through his own 1 Ohm resistor developed a voltage of exactly 1 Volt across the 1 Ohm resistor.

The law was then obvious to him: Amperes **through** Ohms = Volts **across**.

One of his students (Mr. Watt) discovered that he burnt his finger on the (glowing red) resistor. Mr. Ohm laughed and hereafter named this amount of heat (power) to be 1 Watt.

Later he found out that if he connected his resistor **across** a 2 volts battery, the current **through** the resistor became 2 Amperes, and the water for coffee (they used the resistor now to heat the water) was ready 4 times faster!! This indeed was proof that he had found the right name for power because $2 * 2$ (volts times amperes) amounted to exactly 4 (=watts dissipated). Students nowadays must rehearse Ohms law for several years or at least until they have graduated. Some of them discover that a high impedance (Ohms) does not heat the water so fast (less power) and the battery lasts longer (the source is not loaded as much). Some of them discover that the battery has an internal (source) resistance, which puts a limit to how fast the coffee water can be made ready (a resistance to deliver »what's« asked for).

Within audio, inputs should be high impedanced not to load the source (the instrument), whereas output impedances must have a low Ohm value, to ensure a powerfull drive capability, immune to cable- and loading impedances.

Parameter, parameter-value. Parameters or 'variables' on the TC 2290 are e.g. delaytime, volumesettings, feedback, presetno., etc. The parameter values can be e.g. 100 mS, '85', 20% '11' etc. Parameters affecting your mood are 'success in achieving your goals', 'if the sun is shining', 'understanding the things you're working with' etc.

Preset. A stored combination of sound-setting parameters on the TC 2290 making up a complete 'preset' effect-sound. Many different preset sound combinations can be stored in an electronic memory. With simple commands you can then recall the different 'preset'tings.

PROM (Programmable Read Only Memory) – A chip capable of containing 'software'. In the 2290 this software decides how the 2290 functions. It can only be re-programmed with specialized equipment. That's why it is called 'Read Only'. The 'PROM' is the part that you shift when getting new software for the TC 2290.

Rack, a case in which electronic devices of the same size can be mounted in a very compact way. The standard rack size is 19" (inches) wide, (like the TC 2290). The height of a device is measured in 'U'(units) of 1.75" per unit.

RAM (Random Access Memory) – A more explanatory name, although it is seldomly used is Read and Write Memory. This is the type of chip used for storing the sound (writing) for later replay (reading). On the 2290 each second of delay/sample requires 1.000.000 bits of information. Thus the 32 seconds option to the 2290 is a number of DRAM chips capable of storing some 32.000.000 bits of information!

Release, (see also envelope). On the TC 2290 release expresses the fade-out time that elapses between 'threshold is no longer exceeded' to the time of minimum effect. Using SPEED, 10Hz expresses a time of 1/10 second Hz equals 1 second and 0.10 Hz expresses 10 seconds.

Signal. The output from your instrument, the outputs from the TC 2290 etc. are signals (electric signals), and this is the sense of 'signal' as used in this manual. The signal level can be measured in volts or dBs.

Sine. You should be ashamed of yourself. The snake and sometimes the female homo sapiens move in a sine wave-like pattern.

The pure tone of a triangle or a singing crystal glass also follows a sinewave pattern, except that this is usually several thousand cycles per. sec. or Hz. Even microscopic distortions are very easily heard on a sine, due to the fact that a pure sine wave has **no** (camouflaging) harmonics.

SMPTE. A time code for video and audio purposes. Originally introduced by the American Society of Motion Picture and Television Engineers, and now a standard code by which many electronic devices (studio tape-machines, mixers and effects) can be synchronized together.

S/N ratio – Signal to Noise ratio figure, see Dynamic Range.

SPEED, see LFO speed, attack and release.

String, set of commands (keystrokes).

Threshold, on the TC 2290, is a certain level of the input signal, used in connection with the ENV. and TRIG modulations. When threshold is exceeded a modulation takes place, when threshold is no longer exceeded the modulation effect fades out (is released).

The TC 2290 has 4 user adjustable thresholds (set by SPEC.NO. 10-13). The thresholds control at what input signal level, the modulation effect is activated.

Width, see LFO depth.

XLR. XLR in – and output sockets mainly used in studios and in PA-systems. Also called 'Canon' plugs/sockets. Note that using a XLR connection does not necessarily imply that the signal is or has to be balanced. (see balanced) On TC 2290 all the XLR signal connections can be used balanced or unbalanced. Check the tech.specs. for wiring and signal levels.