

*WAVE*

**SERVICE MANUAL**

**Version 0.50 english**

**Sun Jan 9 14:35:01 MET 1994**

**Preliminary Description - subject to change**

# Contents

---

<b>Contents</b> .....	<b>2</b>	LED Test.....	8
<b>Diagnostic System</b> .....	<b>3</b>	Keyboard Test.....	9
Preface .....	3	Debugger .....	10
Starting the Diagnostic System.....	4	<b>Schematic Diagrams</b> .....	<b>11</b>
CPU Board Check.....	5	Panel Boards.....	12
Do all checks .....	5	Panel Boards Position Prints.....	18
Memory Check .....	5	Bus Board.....	19
Interrupt Check.....	5	Bus Board Position .....	21
I/O System Check.....	6	CPU Board .....	22
System Configuration Check .....	6	CPU Board Position Print.....	31
WDV Board Check.....	7	WDV Board.....	32
Checking a WDV Board.....	7	WVC Board.....	47
PANEL Check.....	8	WVC Board Position Print.....	52
Button Test .....	8	<b>Appendix</b> .....	<b>53</b>
Fader/Pot Test.....	8	Special MIDI cable for CPU Board I/O Check....	54

# Diagnostic System

---

## Preface

The current release of the Wave Diagnostic System is part of the WAVE OS, which is to be booted during system startup. Due to this it is currently not possible to run the diagnostic software without booting the system. Future releases will be part of the Boot PROM and can then be used even if the hardware fails to boot.

The current Wave Diagnostic System contains self test functions for the CPU Board itself, the WDV Boards as well as all Front Panel Boards. Wherever possible, diagnostic functions do not need the users attention but try to figure out if a part of the system is working or not by your own.

In contrast to that, the Front Panel Diagnostics need the user's attention, simply because the WAVE has no chance to find out whether a LED, for example, is working or not.

To improve the Diagnostic System we need some response. Please let us know what could be improved, or what you may find completely useless.

VCF calibration:  
Press store  
Hold "shift" & Display 7

Diag: Press Cancel & OK during startup

## Starting the Diagnostic System

The Diagnostic System is started by pressing both CANCEL and OK buttons during system startup. Hold both buttons until following menu screen appears:

```
WAVE DIAGNOSTIC SYSTEM (V 0.50) MAIN PAGE
1 - CPU Board Check
2 - WDV Board Check
3 - PANEL Check
4 - DEBUGGER
0 - SYSTEM RESTART
```

After this menu appeared the Diagnostic System is both controllable from a terminal connected through the Wave Debug Interface and from the WAVE's Front Panel.

To allow control from the Front Panel, some buttons got special meanings, representing parts of an ASCII keyboard:

<i>Button</i>	<i>ASCII Keyboard</i>
OK	RETURN, ENTER etc.
STORE	- " -
CANCEL	ESCAPE
+ (plus)	+ (plus)
- (minus)	- (minus)
0 ... 9	0 ... 9
HOLD	. (decimal dot)

In the following only ASCII keyboard names will be used, ie. RET or RETURN means both RETURN on an ASCII keyboard and OK on the WAVE's Front Panel.

To select a menu item simply press the corresponding number. Either a submenu will appear or a function will be called.

The Self Test Main Page contains 5 functions:

<i>Display</i>	<i>Description</i>
1 - CPU Board Check	Check the main CPU Board
2 - WDV Board Check	Check WDV Boards 1-3
3 - PANEL Check	Check the WAVE's Front Panel
4 - DEBUGGER	Call the built-in Debugger
0 - SYSTEM RESTART	Restart the WAVE OS

## CPU Board Check

The CPU Board Check Sub Menu contains six sub-functions:

<i>Display</i>	<i>Description</i>
1 - Do all checks	Do some functions automatically
2 - Memory Check	Check the on-board memory
3 - Interrupt Check	Check the CPU interrupts
4 - I/O System Check	Check the CPU I/O subsystem
5 - System Configuration Check	Print configuration information
0 - RETURN TO MAIN MENU	Return to the Self Test Main Page

Pressing the corresponding number will take you to one of the sub-functions.

Pressing '0' will return you to the SELFTEST MAIN PAGE.

### Do all checks

The "Do all checks" subfunction calls the subfunctions "Memory Check", "Interrupt Check", "I/O System Check" and "System Configuration Check" in this order, plus the WDV Board check for all installed WDV Boards.

Each check prints a status message as its own, a final status message telling whether the complete check has passed or failed is printed last.

For a detailed description of these tests please refer to the corresponding sections.

### Memory Check

The Memory Check subfunction checks all memory systems on the WAVE CPU Board. While running, it will print the following information:

```

----- Memory Check -----
Checking Bus Error Exception: OK
Checking DRAM [1024 kB expected]: [kB] OK
Checking SRAM [ 512 kB expected]: [kB] OK
Checking VRAM [ 16 kB expected]: [kB] OK
Memory Check: PASSED [FAILED]
Press RET to continue.

```

If in any of the memory subsystem less memory than expected is found, the Memory Check failed.

After completing the check, press ENTER to return to the CPU Board Check menu.

### Interrupt Check

The Interrupt Check subfunction checks all on-board generated interrupts of the the WAVE CPU Board.

While running it will print the following information:

```

----- Interrupt Check -----
Saving Vectors...
Checking Timer Interrupt: OK [269]
Checking Midi 1 Interrupt: OK [0]
Checking Midi 2 Interrupt: OK [0]
Checking Serial Interrupt: OK [0]
Checking Floppy Interrupt: OK [573]
Restoring Vectors...
Interrupt Check PASSED
Press RET to continue.

```

If any of the tested interrupts failed the test functions will print "TIMED OUT" instead of "OK".

The number displayed in brackets behind the "OK" is just informational. It may differ from the numbers given here.

The Serial Interrupt Check has a third possible result. It might print "INTERFACE NOT CONNECTED" telling you that the WAVE Debug Interface is not connected. This is not an error condition since this Interface is optional and not necessary for normal operation of the WAVE and its Diagnostic System.

Press RETURN to return to the CPU Board Check menu.

## I/O System Check

The I/O System Check prints information about the functionality of the I/O subsystem of the WAVE CPU Board. You need a special cable and a formatted floppy disk to successfully run this test.

While running the I/O System Check will print the following information:

```

----- I/O System Check -----
Checking RTC: OK
Checking Midi Out 1: OK
Checking Midi Out 2: OK
Checking Floppy: Init: OK Read: OK Write: OK
I/O Check PASSED
Press RET to continue.

```

If a test failed, "FAILED" will be printed instead of "OK". Without a special midi cable and a formatted disk the MIDI Out 1 and 2 as well as the Floppy Check will fail.

*Please see the Appendix for a description of the MIDI Test Cable.*

## System Configuration Check

The System Configuration Check is a half-automated test function printing information about the WAVE's hardware configuration. You'll need to find out if the information printed is correct:

<i>Display</i>	<i>Description</i>
CPU Clock:	CPU clock in kHz
CPU Board Revision:	Board Revision, current = 2
WDV Board Type:	NOT PRESENT, OLD, NEW
WDV Boards found:	No. of WDV Boards installed
Optional Boards:	NOT PRESENT, PRESENT
Keyboard Type:	STANDARD, EXTENDED

Press RET to continue.

The System Configuration Check cannot fail since it simply reads some IO ports and interpretes them, except the CPU clock measure which fails when the RTC (Realtime Clock) isn't working. In this case the CPU Clock is displayed with 0 kHz. Please make sure that your system configuration is as displayed, then press RETURN to return to the CPU Board Check menu.

## WDV Board Check

The WDV Board checks consists of 4 subfunctions:

```
WDV BOARD TEST
1 - Board 1
2 - Board 2
3 - Board 3
0 - RETURN TO MAIN MENU
```

Pressing buttons 1,2,3 starts a check of WDV Board 1, 2 or 3, respective. Pressing button 0 returns you to the main menu.

## Checking a WDV Board

After selecting a WDV Board to check, the Diagnostic System will print following informations:

```
----- Digital Voice Boards Check -----
Checking Board [1,2,3]:
Resetting all WDV Boards...
Checking Presence of Board [1,2,3]: OK
Starting Board [1,2,3] : OK
Checking Communication : OK
WDV Board Check PASSED
Press RET to continue.
```

Any other message indicates an error.

**Note:** The WDV Board check ignores the system configuration port. You can try to check a WDV Board which is not installed. This will obviously fail but is not recognized as a general error condition.

## PANEL Check

The PANEL Check consists of several subfunctions again. After selecting the PANEL check from the Diagnostic System Main Page the following menu will appear:

<i>Display</i>	<i>Description</i>
PANEL AND KEYBOARD TEST	
1 - Button Test	Test all panel buttons
2 - Fader/Pot Test	Test all panel pots and faders
3 - Led Test	Test all panel LEDs
4 - Keyboard Test	Test the keyboard
0 - RETURN TO MAIN MENU	Return to the Main Menu

Select a subfunction by pressing the corresponding button 1,2,3,4 or 0. Pressing '0' will return you to the Diagnostic System main menu.

**Note:** The function Keyboard Test isn't available in this version. Selecting it will again print the PANEL and KEYBOARD TEST menu.

### Button Test

The Button Test consists of 5 pages, each displaying a number of buttons on the WAVE's Front Panel, in order from the left to the right. Within each page you can skip to the next page by pressing RET or cancel the complete Button Test by pressing ESC.

Pressing a displayed button twice will let this button disappear from the Display, but only if this button works fine, i.e. both 'press' and 'release' states could be identified, and no other button was affected by pressing or releasing it.

The last received button state message is displayed in the upper right corner of the display.

### Fader/Pot Test

The Button Test consists of 4 pages, each displaying a number of pots or faders on the WAVE's Front Panel, in order from the left to the right.

Page 4 displays the three wheels, the keyboard pressure sensor and the three pedal inputs. Within each page you can skip to the next page by pressing RET or cancel the complete Fader/Pot Test by pressing ESC.

Turning a pot first to the right and then to left will let this pot disappear from the Display, but only if this pot works fine, i.e. both minimum (0) and maximum (127) values were detected.

The last received pot value message is displayed in the upper right corner of the display.

### LED Test

The LED Test consists of 8 pages, each displaying a number of LEDs on the WAVE's Front Panel, in order from the left to the right. The current LED is highlighted on the Display. The corresponding LED on the WAVE's Front Panel must be on, otherwise it's an error.

Pressing RET always selects the next LED and/or page. Pressing ESC cancels the complete LED Test.

There's no way for the WAVE to find out whether a LED is working or not. You have to watch if the highlighted LED is on or not yourself.



## Keyboard Test

The Keyboard Test isn't available in this version, nor has been decided how it will look like. Future releases of the Diagnostic System will include this test and its documentation.

# Debugger

The build-in Debugger of the WAVE OS is not part of the Diagnostic System but accessible from there. Unless you are controlling the Diagnostic System from a terminal you should not start the Debugger since there's no way to return to the Diagnostic System without an ASCII keyboard. The Debugger will be described in another document not yet available.

# Schematic Diagrams

---



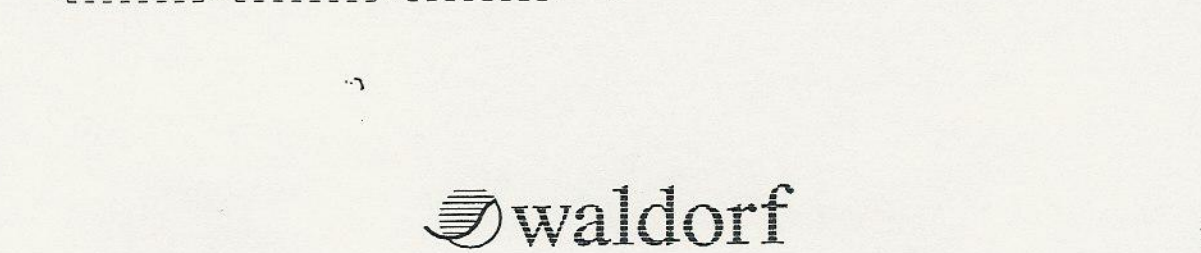
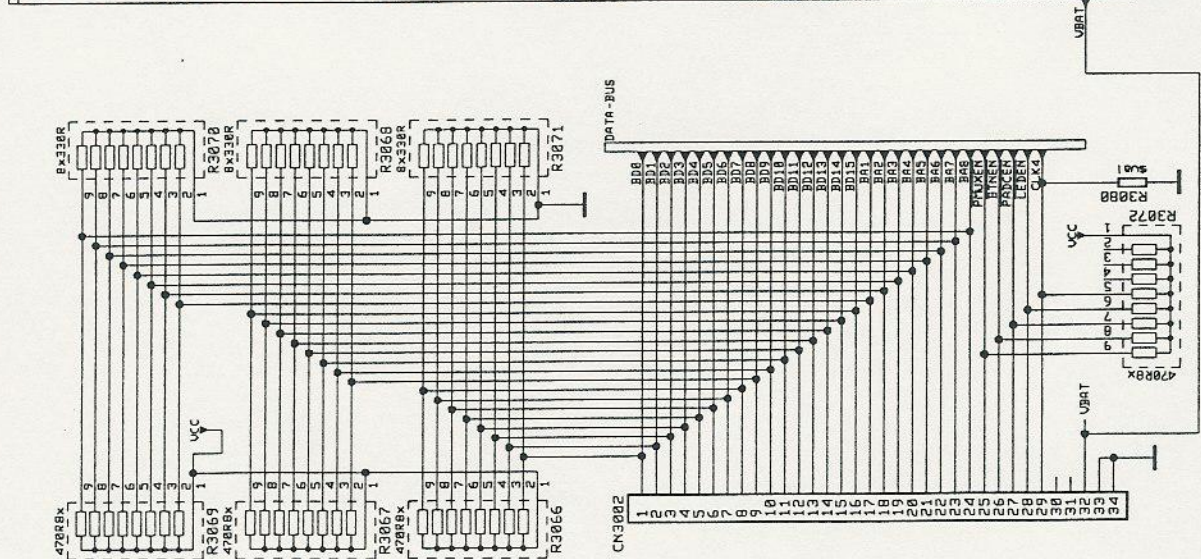
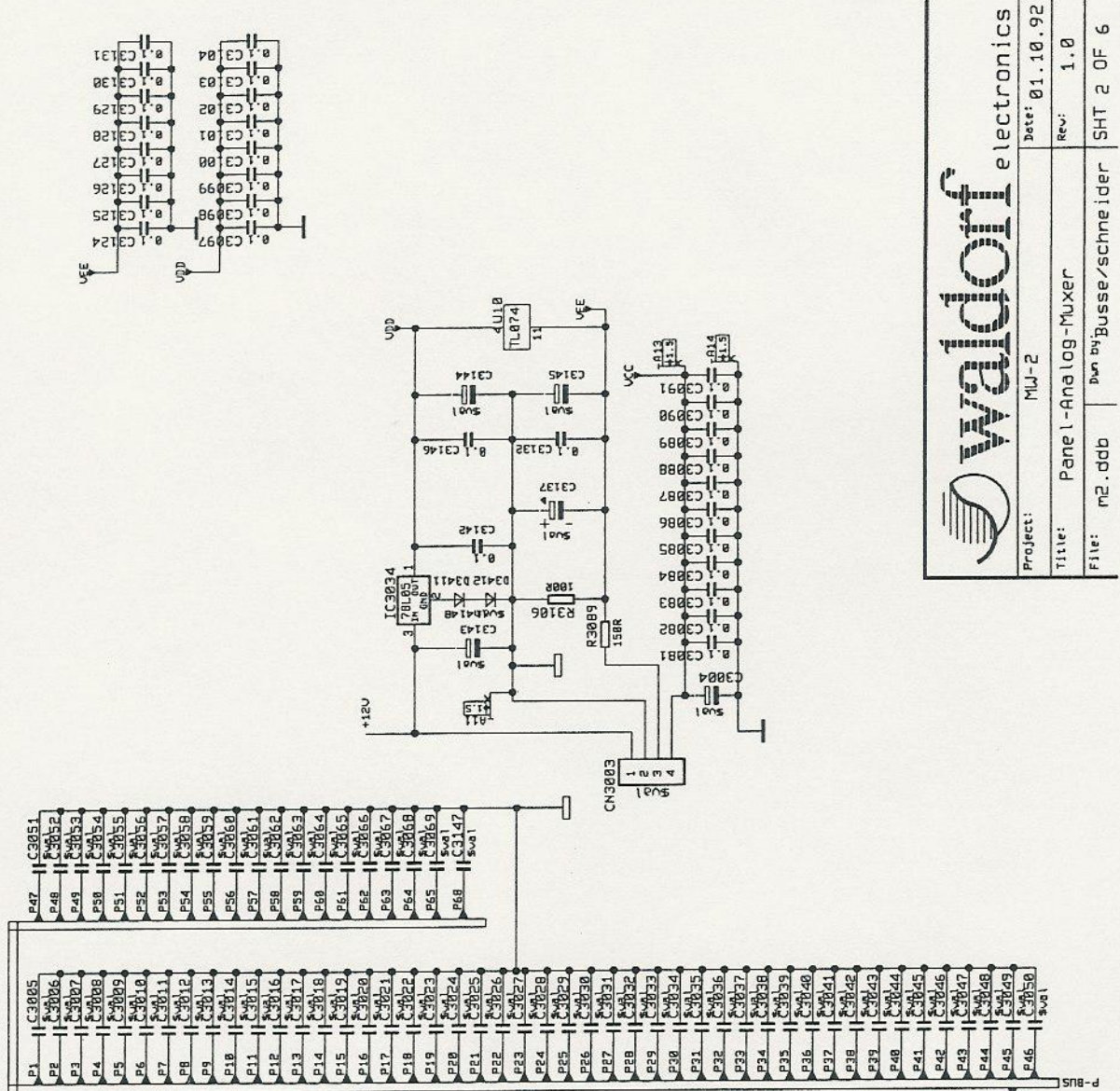

**waldorf** electronics

Project: MJ-2      Date: 01.10.92

Title: Panel-Analog-Muxer      Rev: 1.0

File: m2.ddb      Drawn by Busse/schneider      SHT 2 OF 6

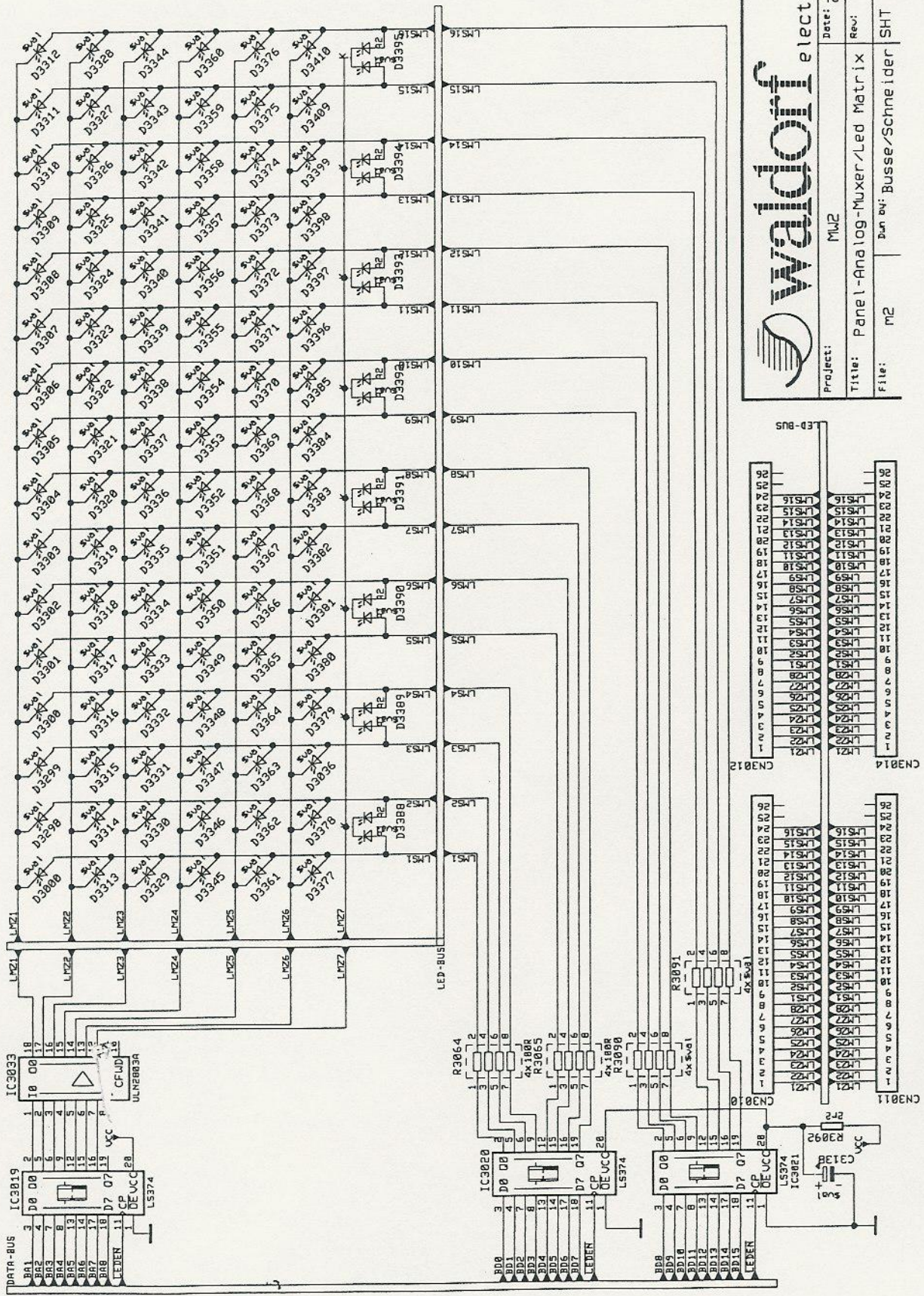

**Waldorf** electronics

Project: M12  
 Date: 28.12.92  
 Title: Panel-Analog-Muxer/Led Matrix  
 Rev: 1.0  
 File: m2  
 Drawn by: Busse/Schneider SHT 3 OF 6



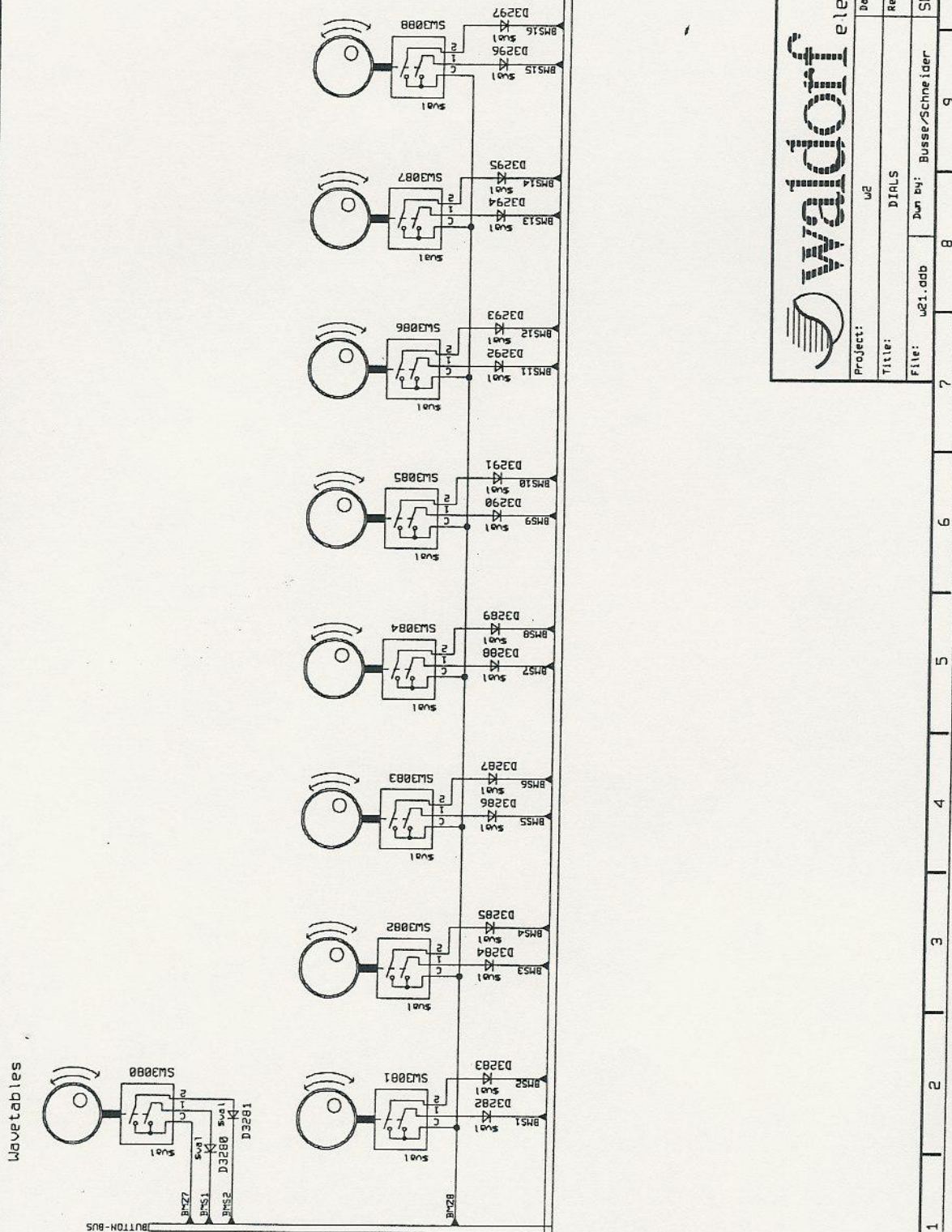

Wavetables

**waldorf** electronics

Project: w2 Date: 28.12.92  
 Title: DIRLS Rev: 1  
 File: w21.dbb Drawn By: Busse/Schneider SHT 5 DF6



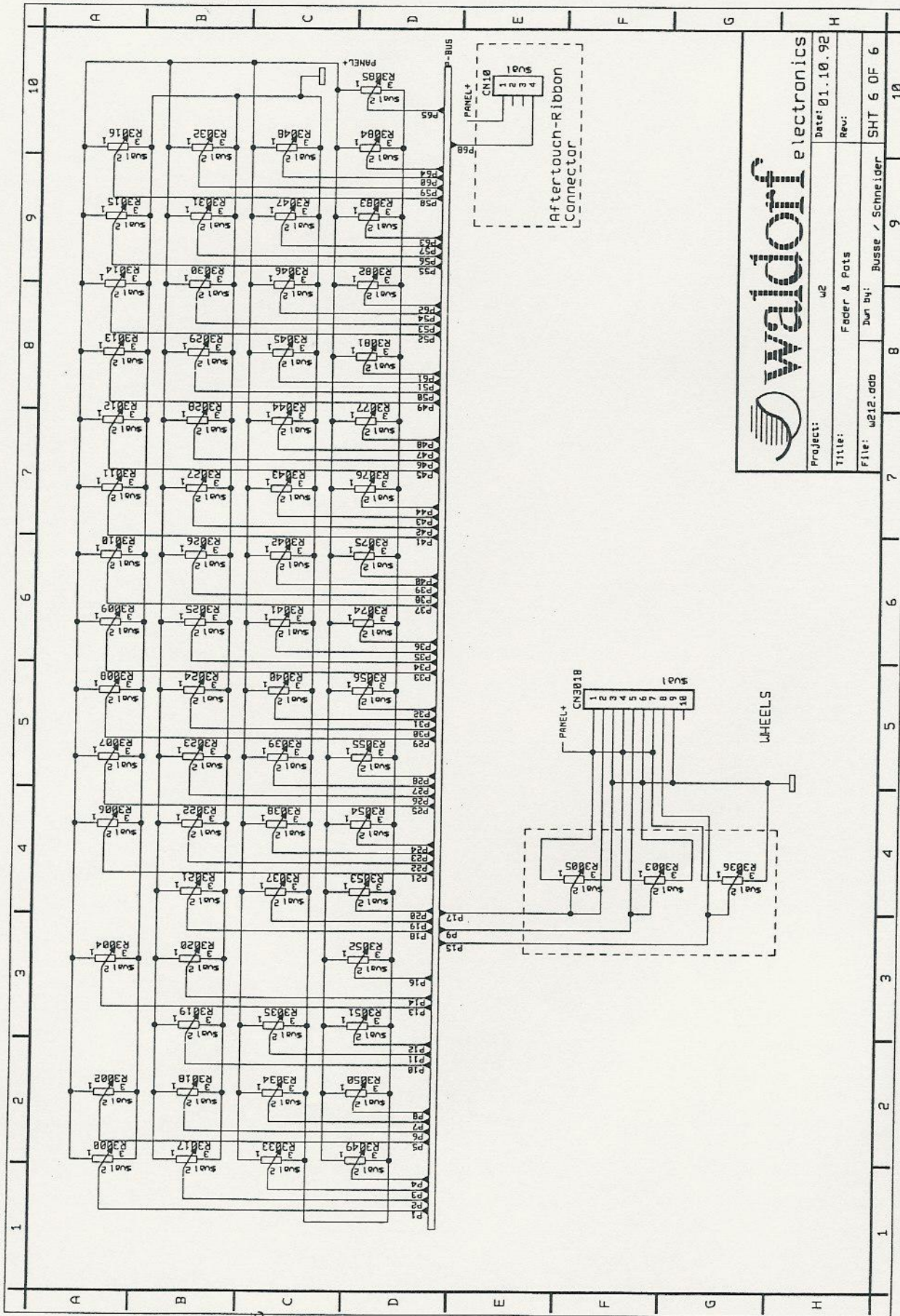

**waldorf** e lectronics

Project: w2  
 Date: 01.10.92  
 Title: Fader & Pots  
 File: w212.dad  
 Drawn by: Busse / Schneider  
 SHT 6 OF 6

# Panel Boards Position Prints





	
Project: WAVE II	BUS-Board
Title: BUS CONNECTION	Rev: REV.1.0
Date: 03.02.93	Drawn by:
File: w2b	SHT 2 OF 2

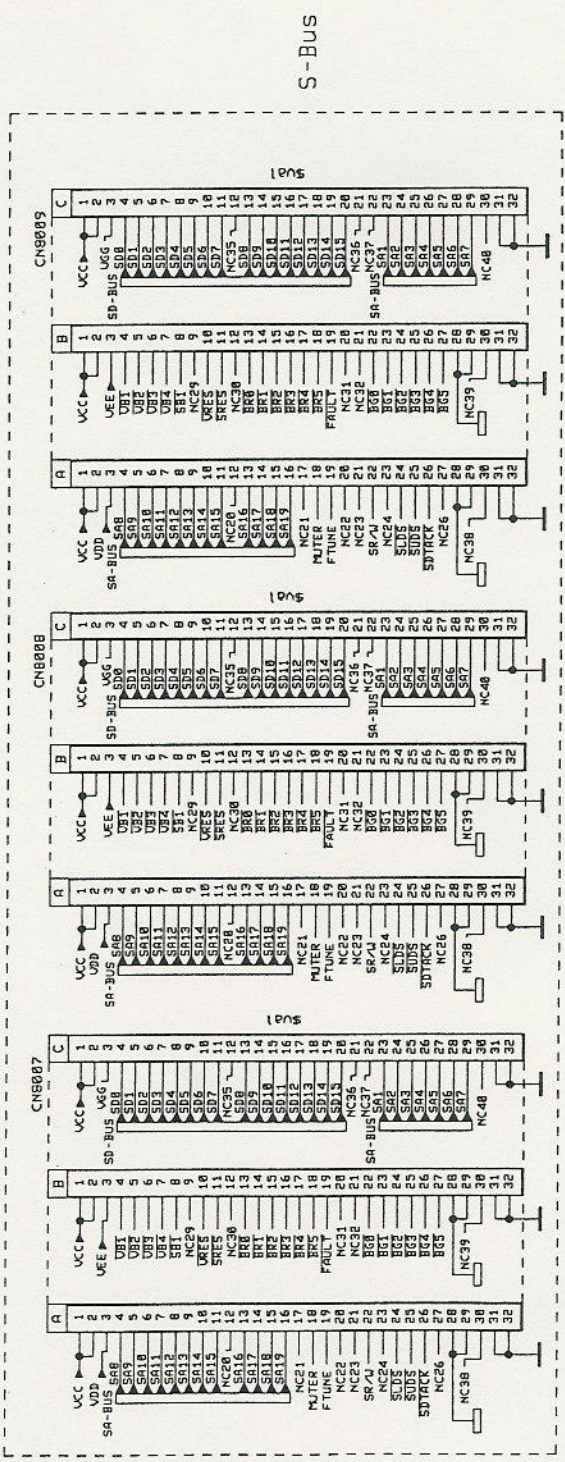
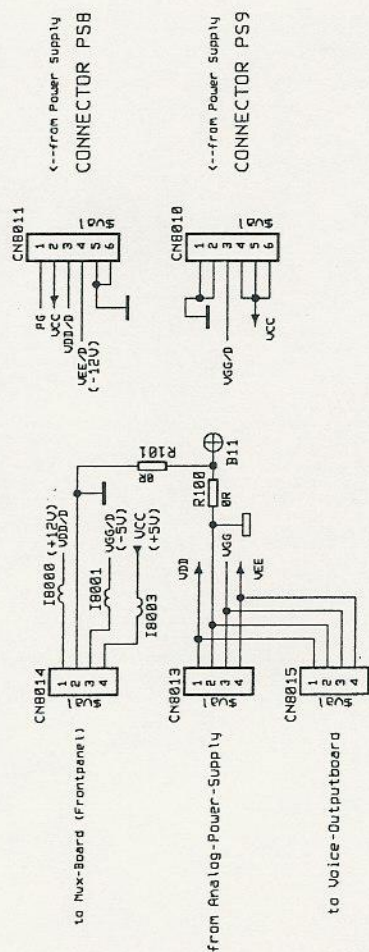

# Bus Board Position



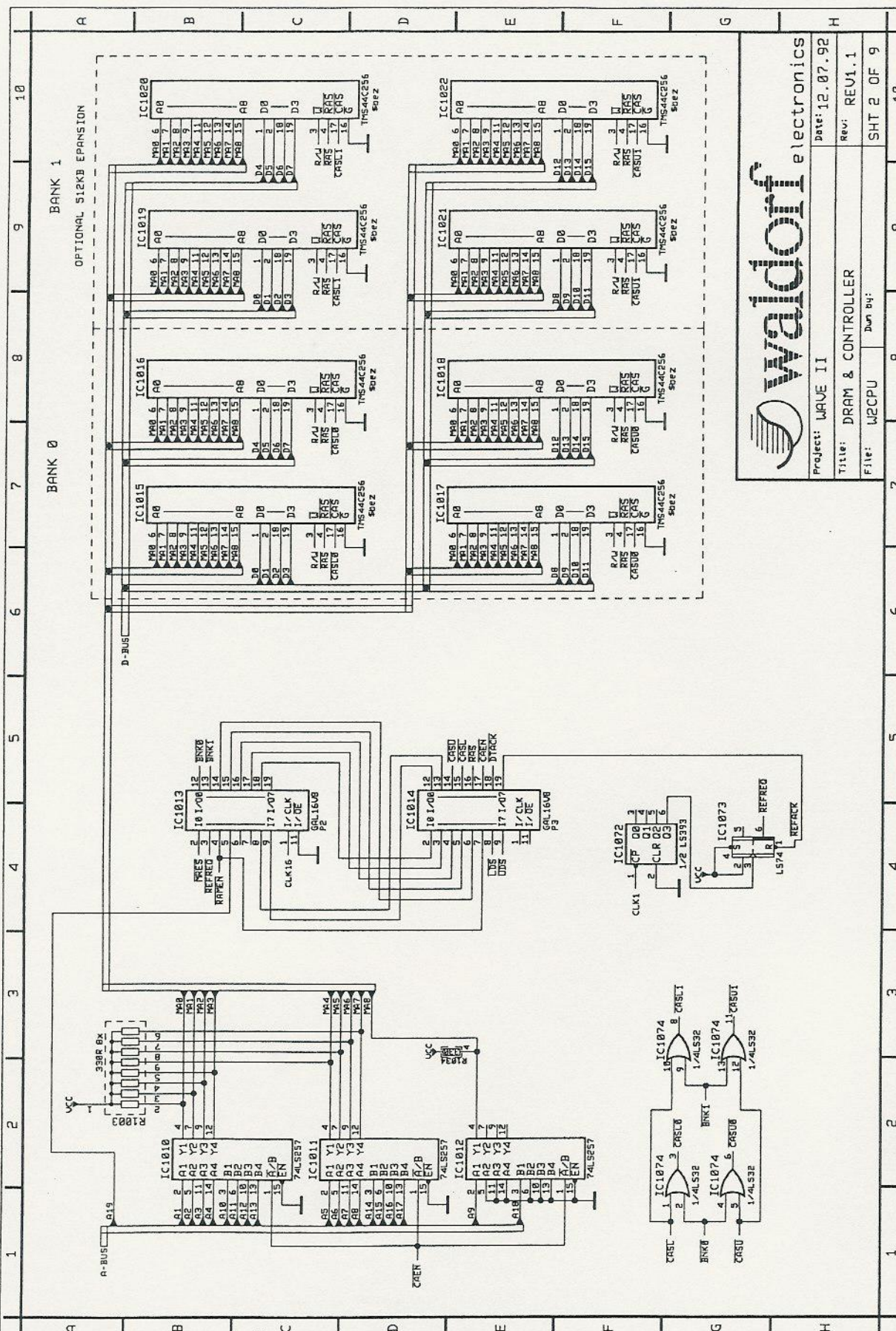

Project: WAVE II Date: 12.07.92  
 Title: DRAM & CONTROLLER Rev: REV1.1  
 File: W2CPU Drawn by: SHT 2 OF 9

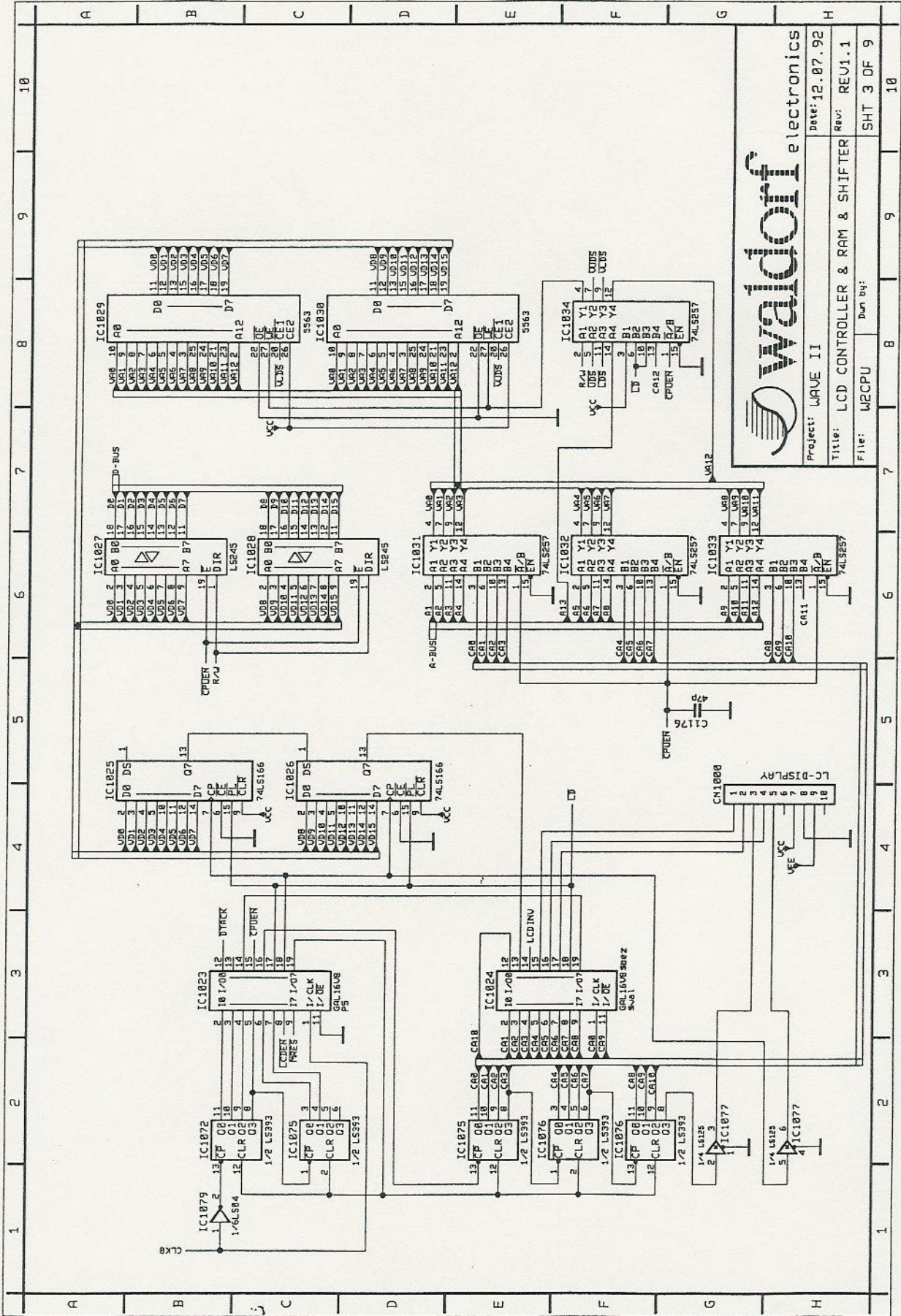

Waldorf electronics

Project: WAVE II  
 Title: LCD CONTROLLER & RAM & SHIFTER  
 File: W2CPU  
 Date: 12.07.92  
 Rev: REV1.1  
 SHT 3 OF 9  
 Drawn By:



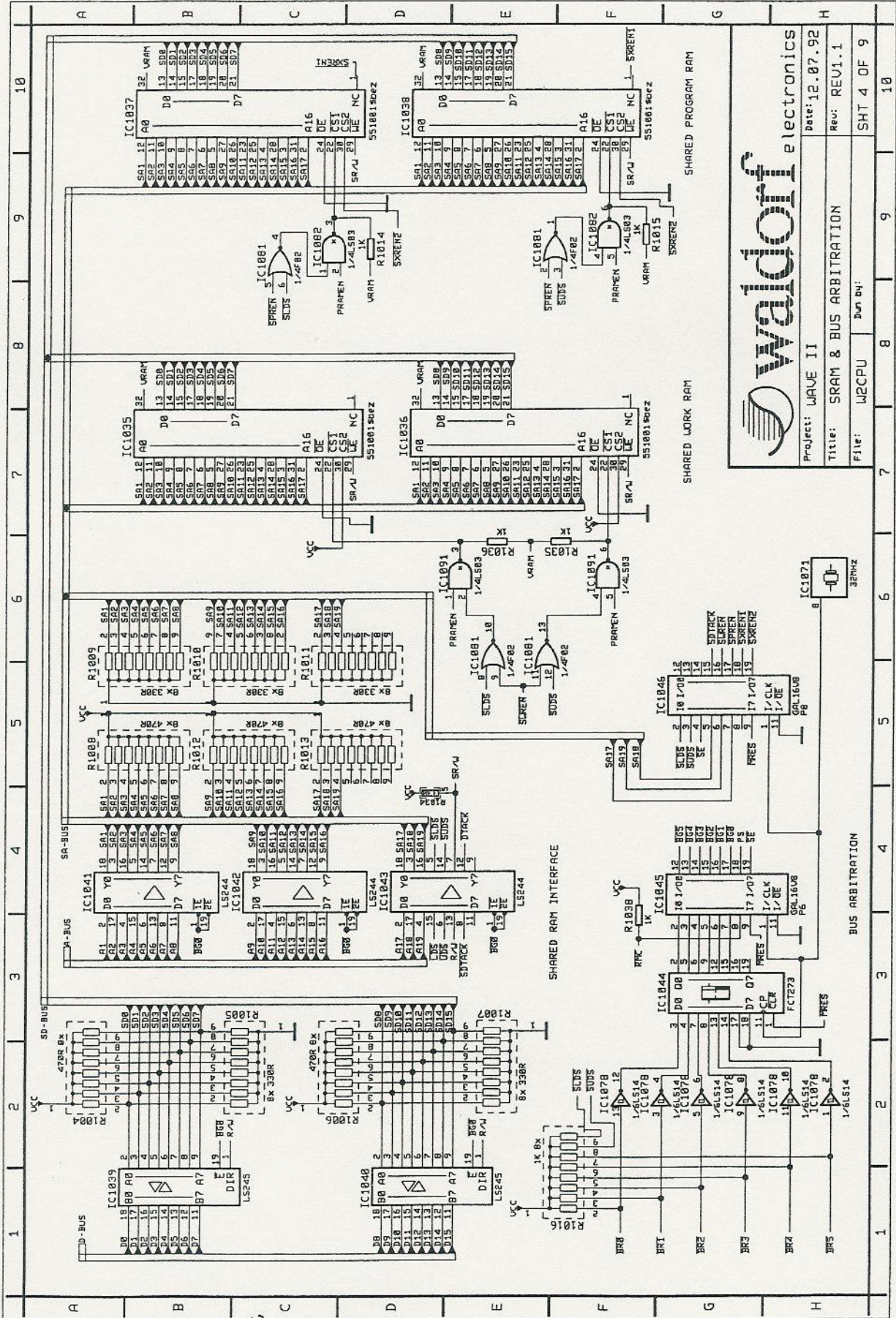

**waldorf electronics**

Project: WAVE II      Date: 12.07.92  
 Title: SRAM & BUS ARBITRATION      Rev: REV1.1  
 File: W2CPU      Drawn by: SHT 4 OF 9

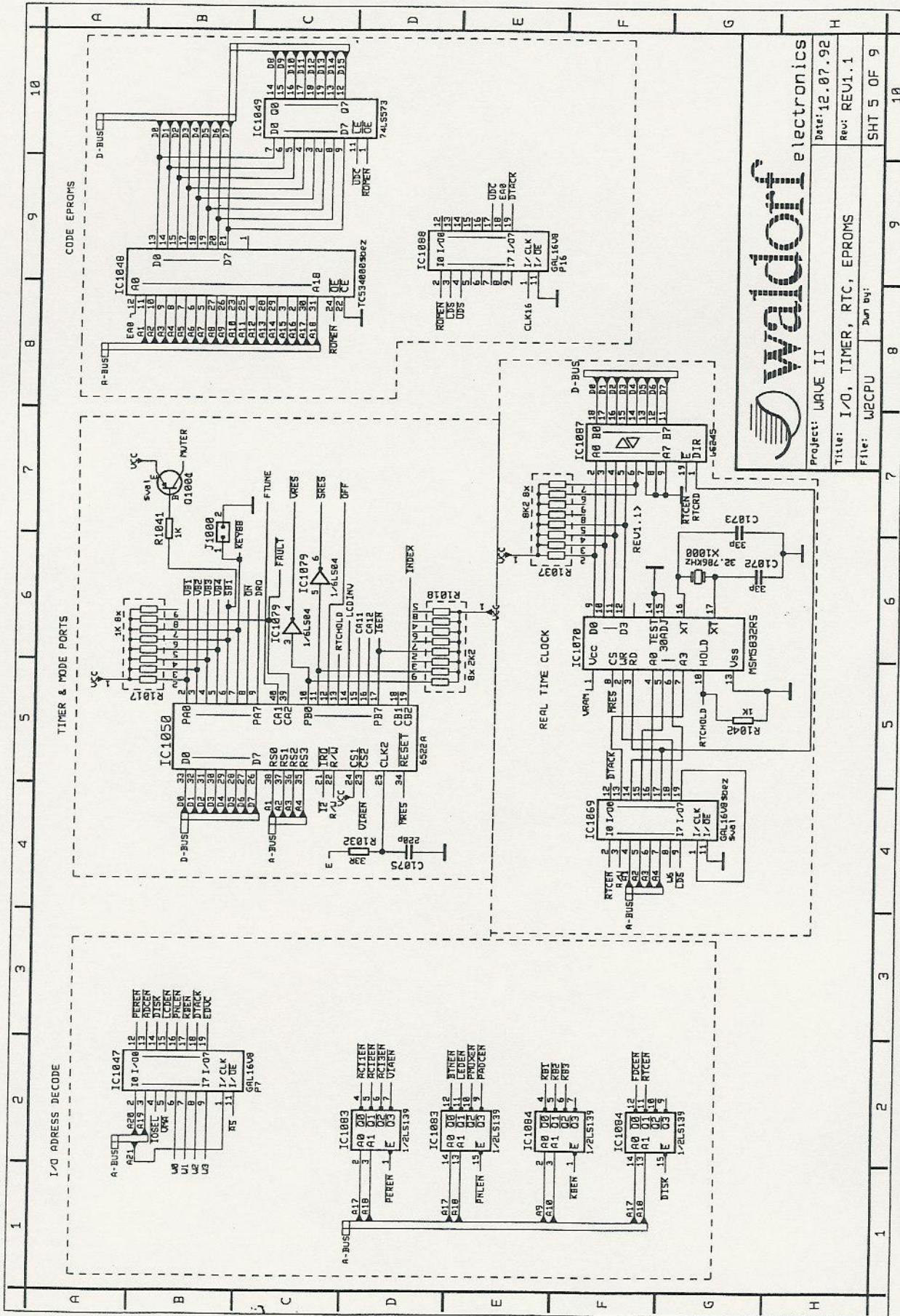

**Waldorf electronics**

Project: WAVE II  
 Title: I/O, TIMER, RTC, EPROMS  
 Date: 12.07.92  
 Rev: REV1.1  
 File: WPCPU  
 Drawn By: SHT 5 OF 9



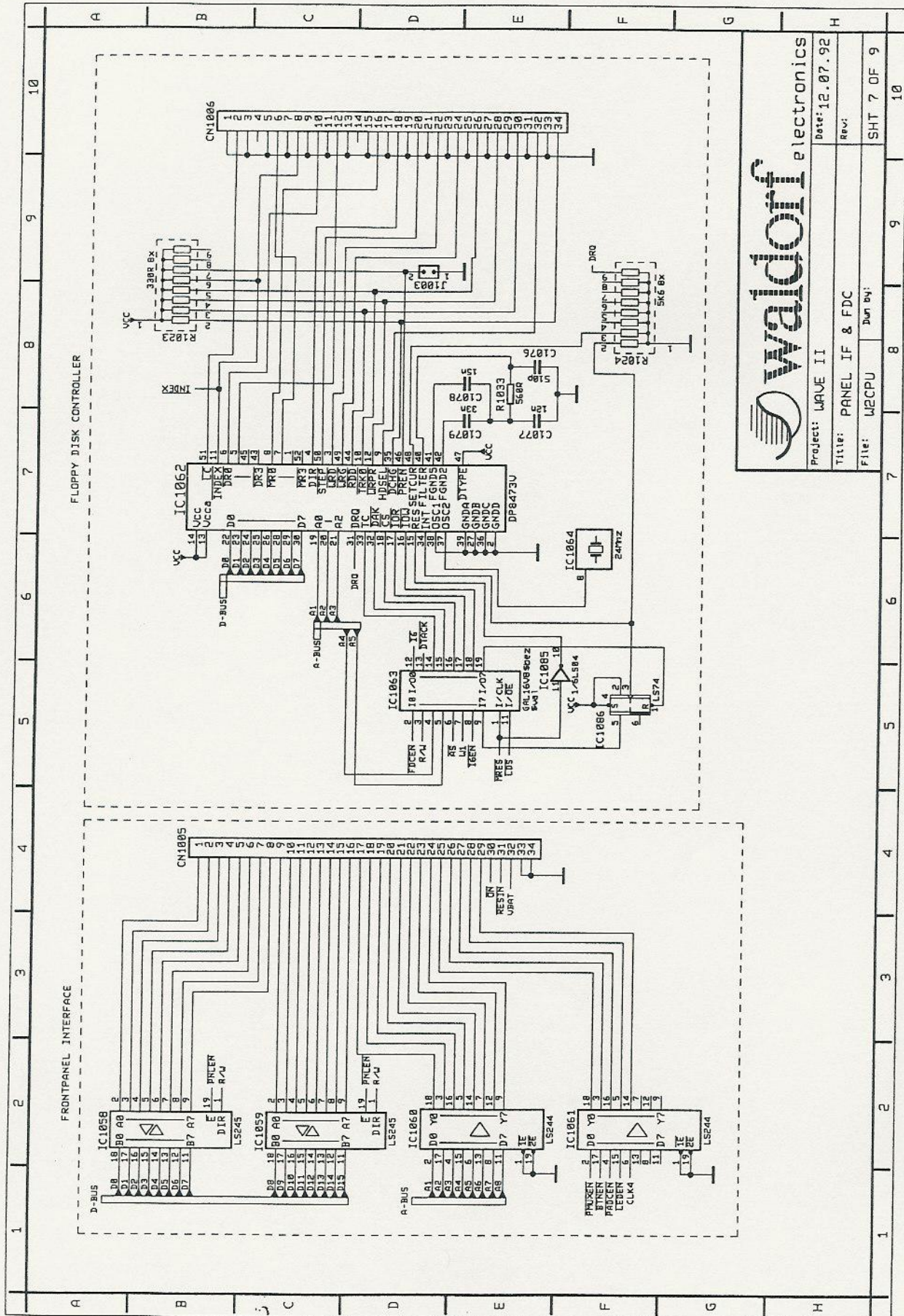

**waldorf** electronics

Project: WAVE II      Date: 12.07.92  
 Title: PANEL IF & FDC      Rev:  
 File: W2CPU      Drawn by: SHT 7 OF 9



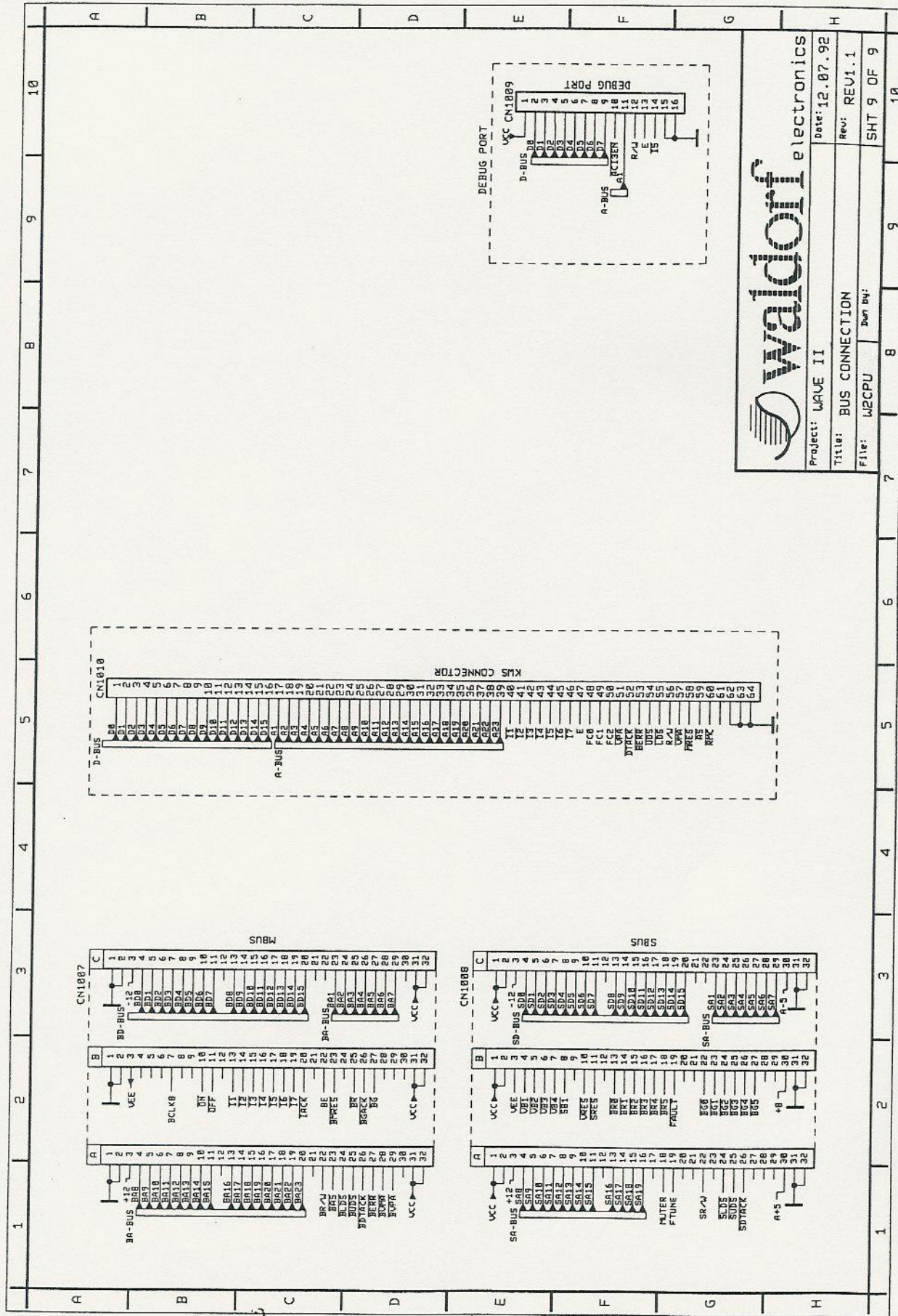

Project: WAVE II  
 Title: BUS CONNECTION  
 File: W2CPU  
 Date: 12.07.92  
 Rev: REV1.1  
 SHT 9 OF 9

# CPU Board Position Print

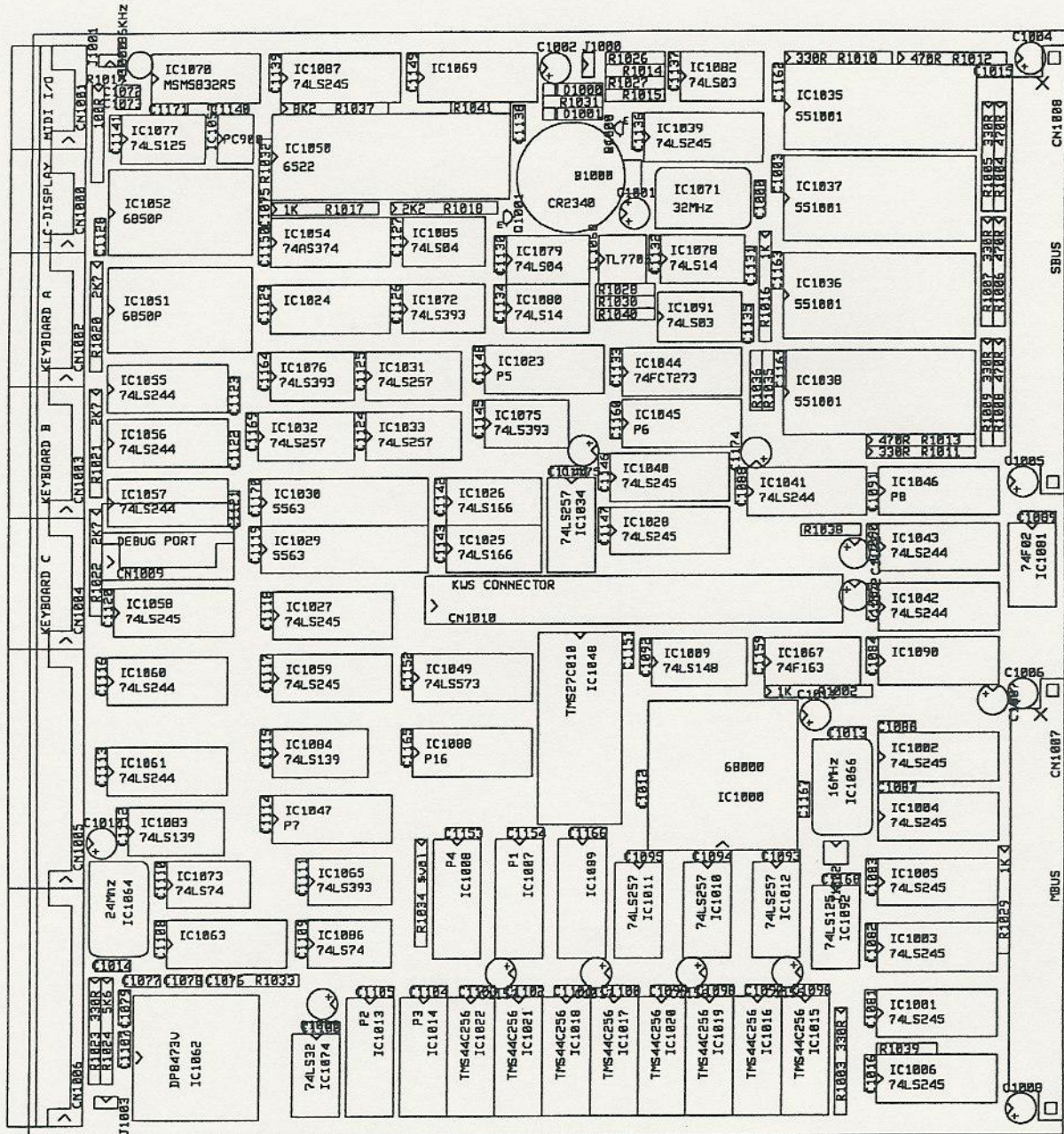

# WDV Board

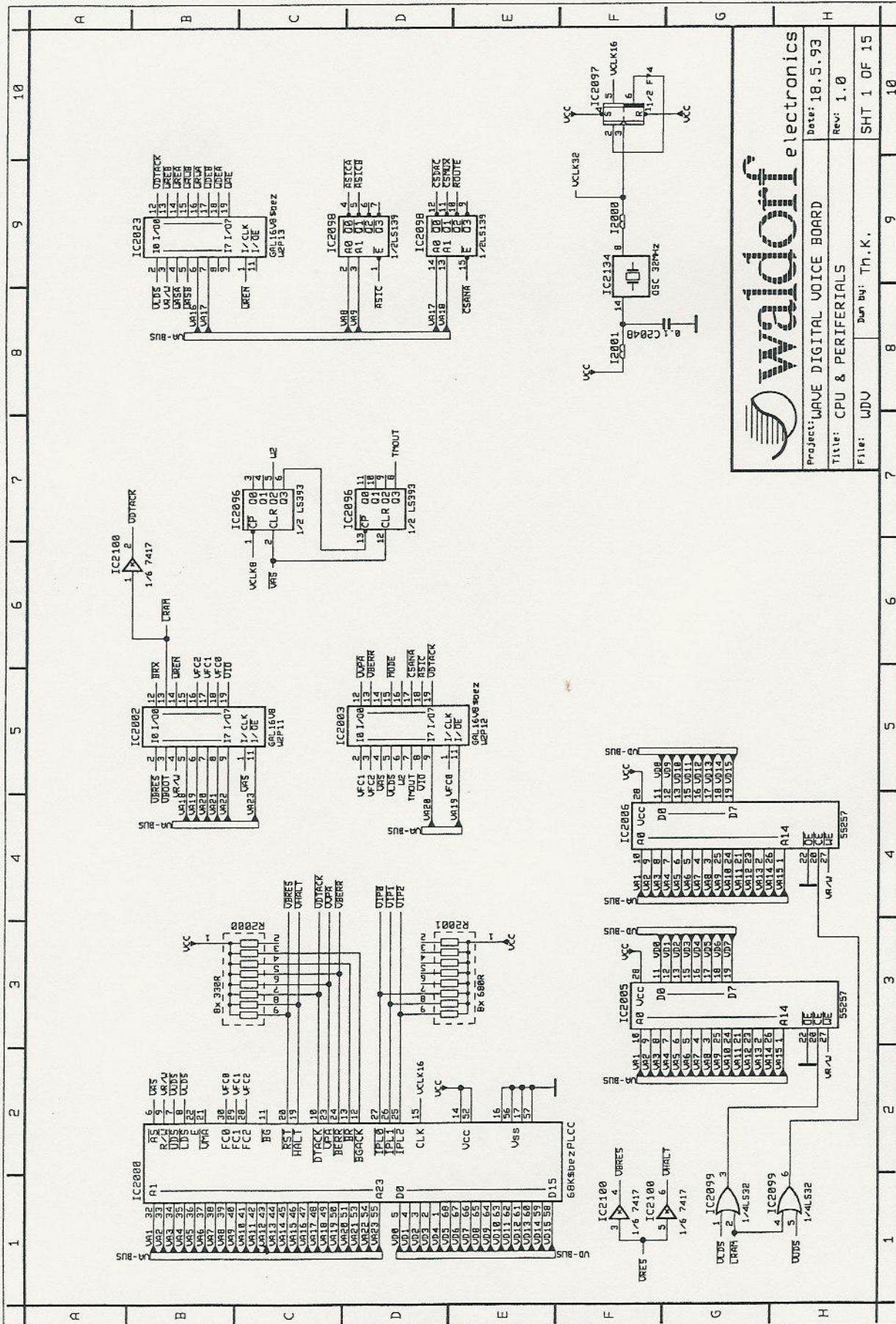

**Waldorf electronics**

Project: WAVE DIGITAL VOICE BOARD  
 Title: CPU & PERIPHERALS  
 File: WDV  
 Date: 18.5.93  
 Rev: 1.0  
 Drawn by: Th.K.  
 SHT 1 OF 15





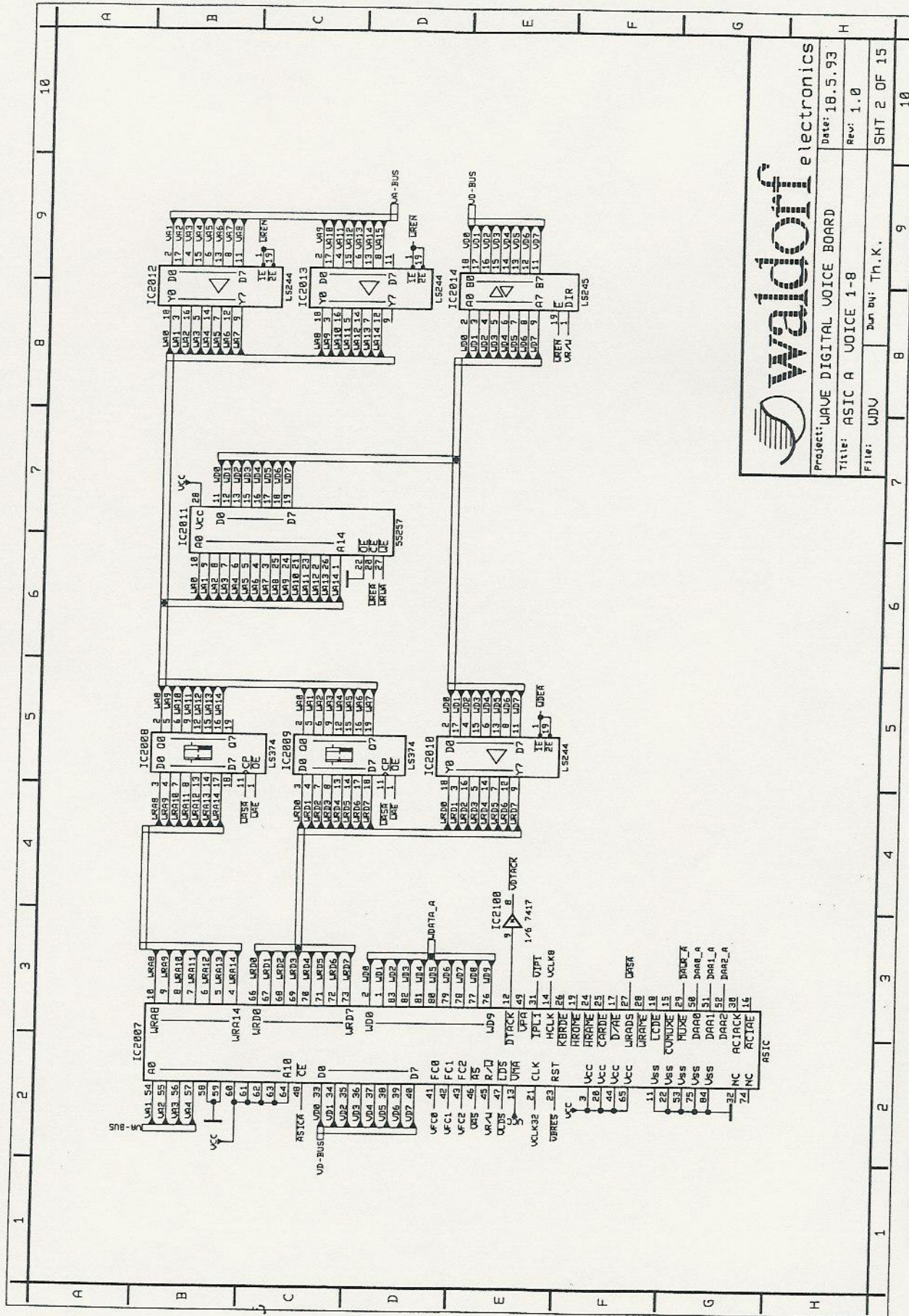

Project: WAVE DIGITAL VOICE BOARD  
 Title: ASIC A VOICE 1-8  
 File: WDU  
 Date: 18.5.93  
 Rev: 1.0  
 SHT 2 OF 15  
 Th.K.  
 8 9 10



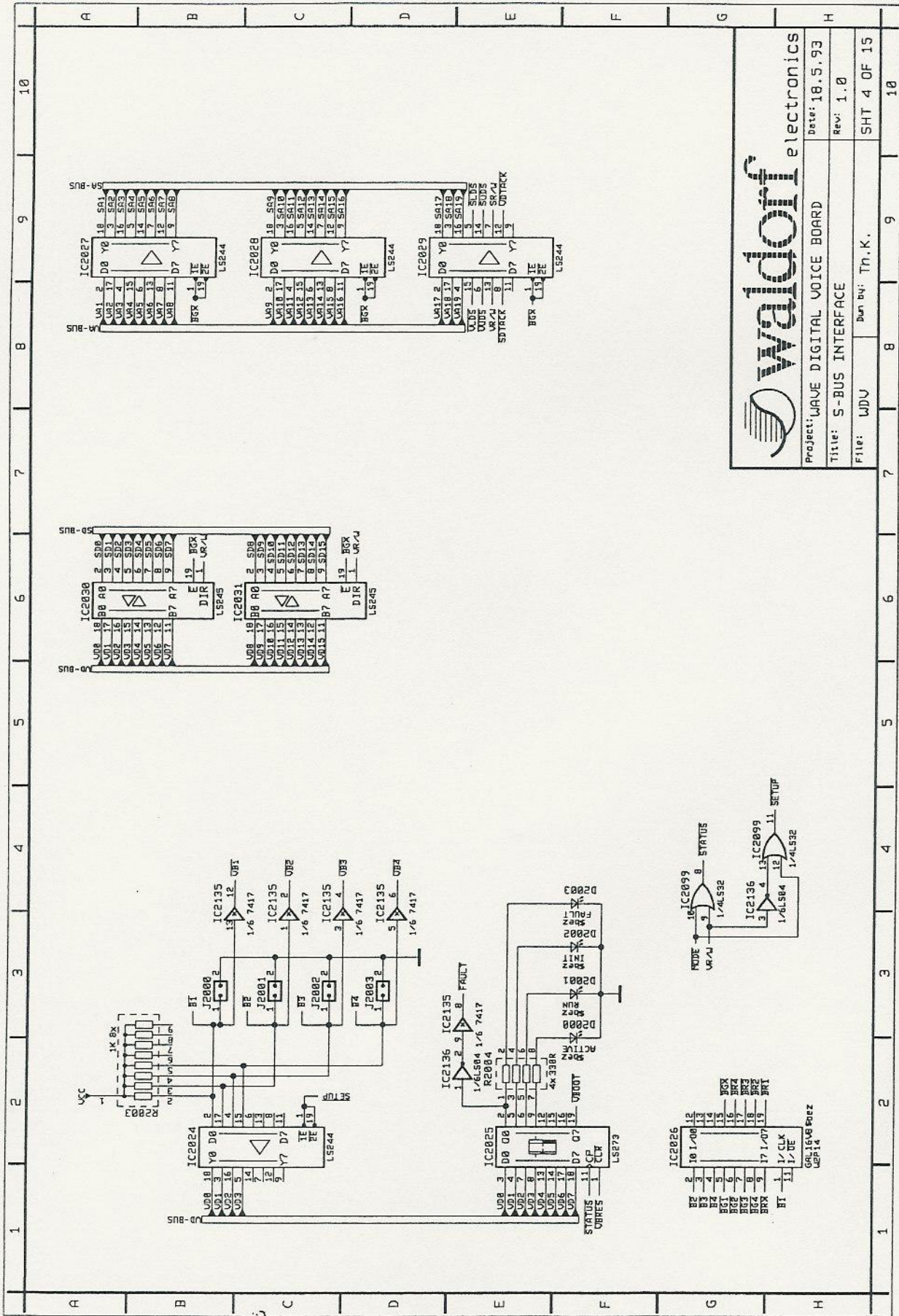

**waldorf** electronics

Project: WAVE DIGITAL VOICE BOARD      Date: 18.5.93  
 Title: S-BUS INTERFACE                      Rev: 1.0  
 File: WDV                                      Des By: Th.K.                      SHT 4 OF 15



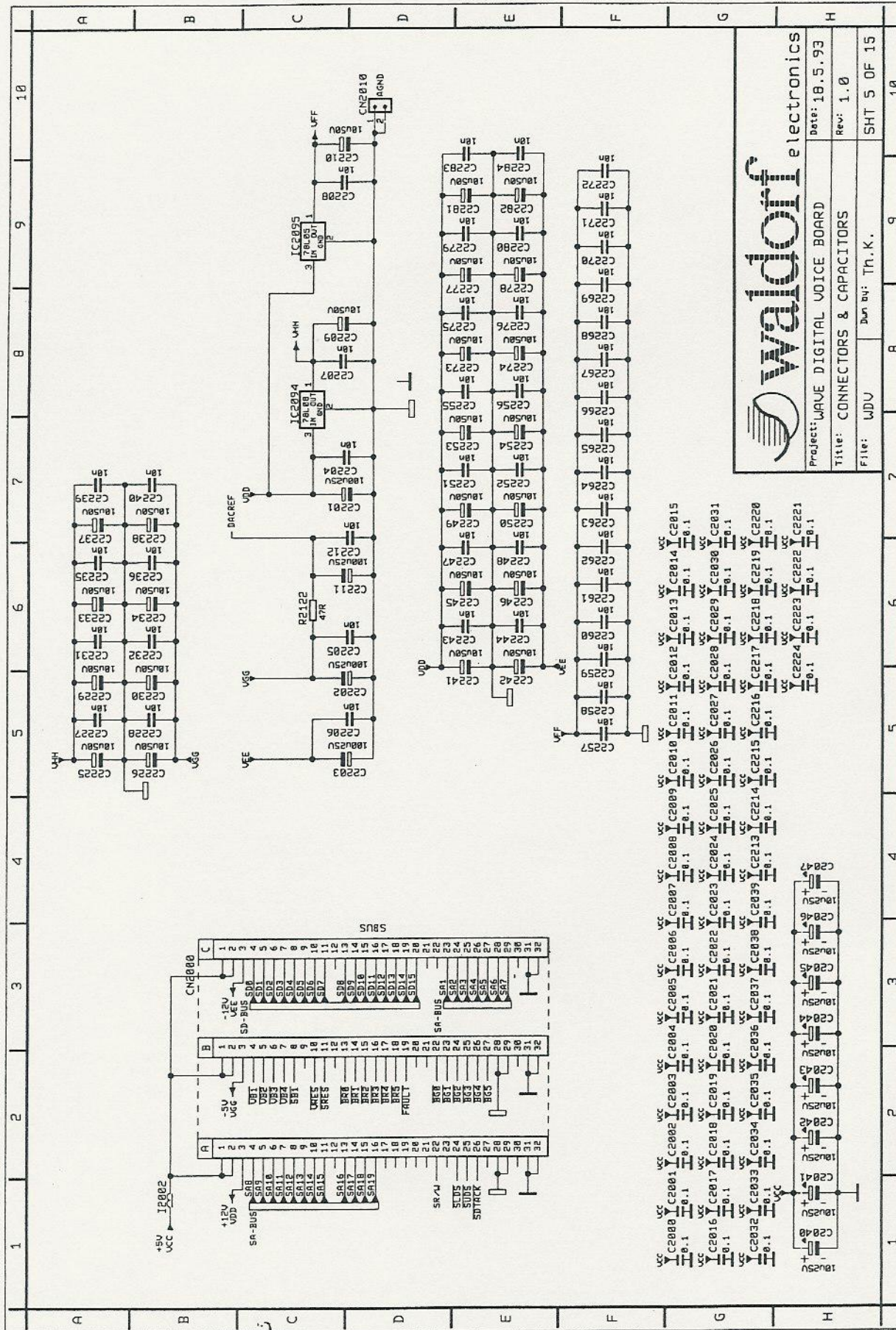

**Waldorf electronics**

Project: WAVE DIGITAL VOICE BOARD      Date: 18.5.93  
 Title: CONNECTORS & CAPACITORS      Rev: 1.0  
 File: WDV      Drawn by: Th.K.      SHT 5 OF 15

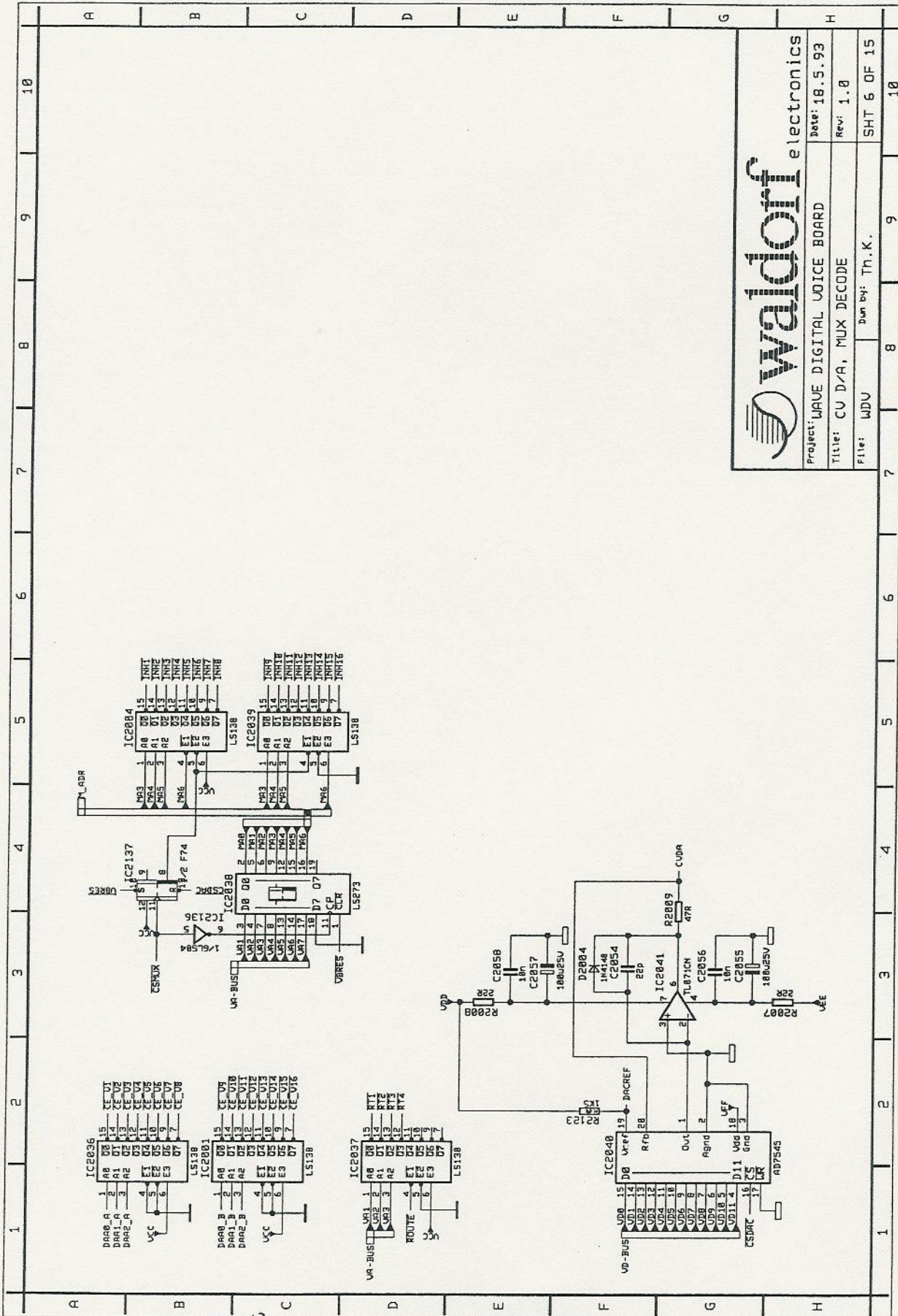

**waldorf** electronics

Project: WAVE DIGITAL VOICE BOARD      Date: 18.5.93  
 Title: CV D/A, MUX DECODE              Rev: 1.0  
 File: WDV                                  Drawn by: Th.K.      SHT 6 OF 15



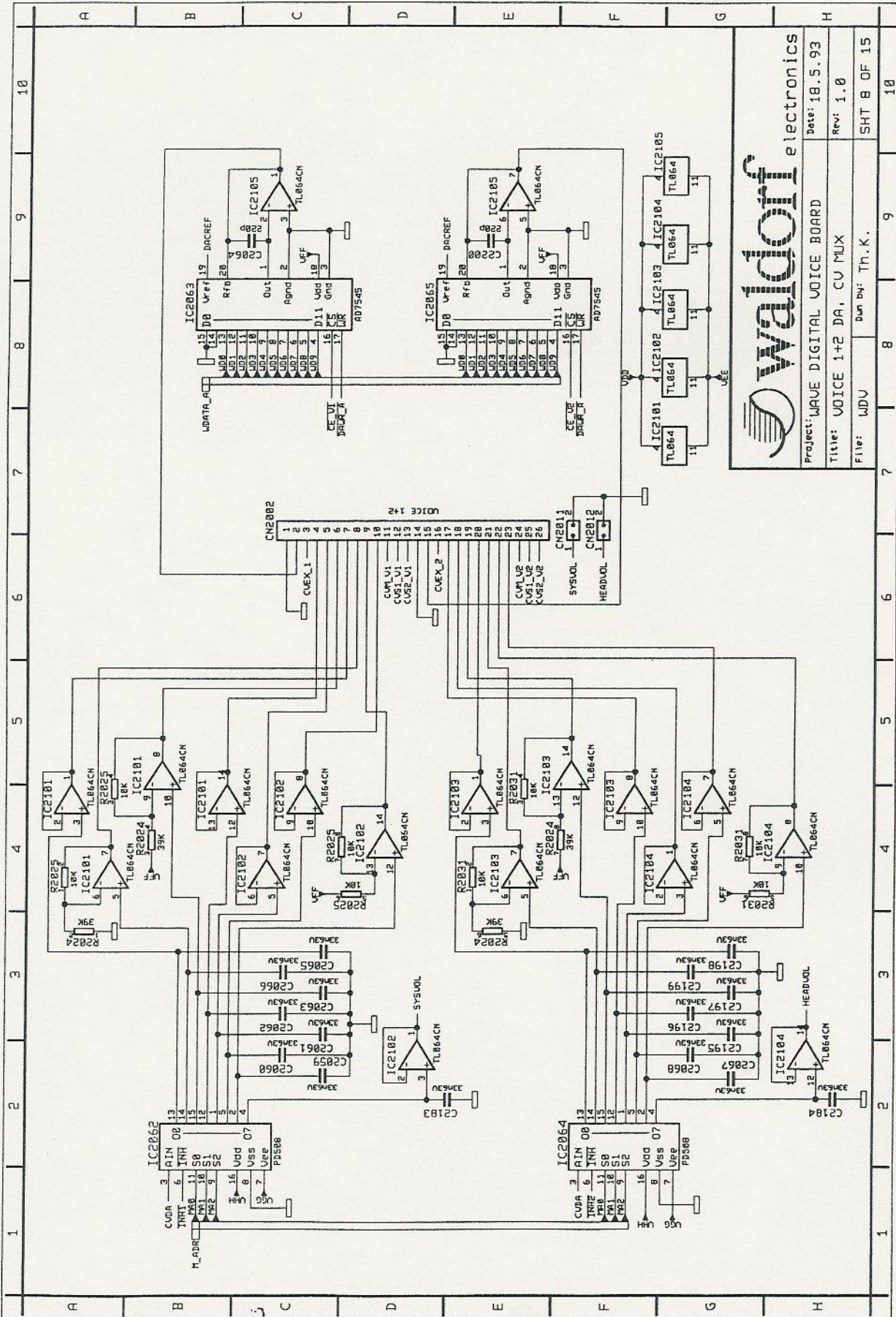

**waldorf** electronics

Project: WAVE DIGITAL VOICE BOARD      Date: 18.5.93  
 Title: VOICE 1+2 DA, CU MUX              Rev: 1.0  
 File: WDV                                      Drawn by: Th.K.                      SHT 8 OF 15









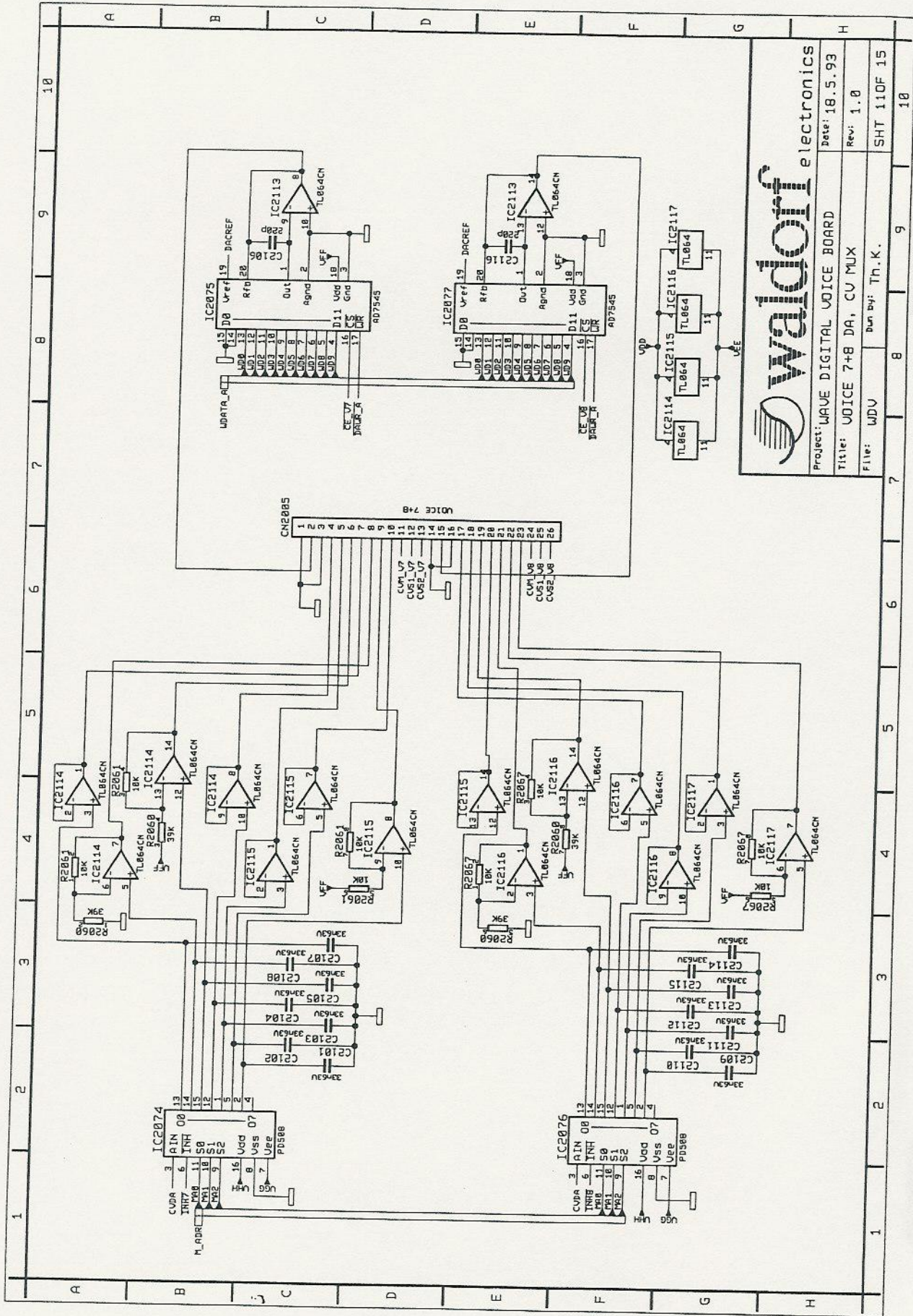

**waldorf** electronics

Project: WAVE DIGITAL VOICE BOARD Date: 18.5.93

Title: UDICE 7+8 DA, CV MUX Rev: 1.0

File: WDV Des by: Th.K. SHT 110F 15

1 2 3 4 5 6 7 8 9 10

A B C D E F G H



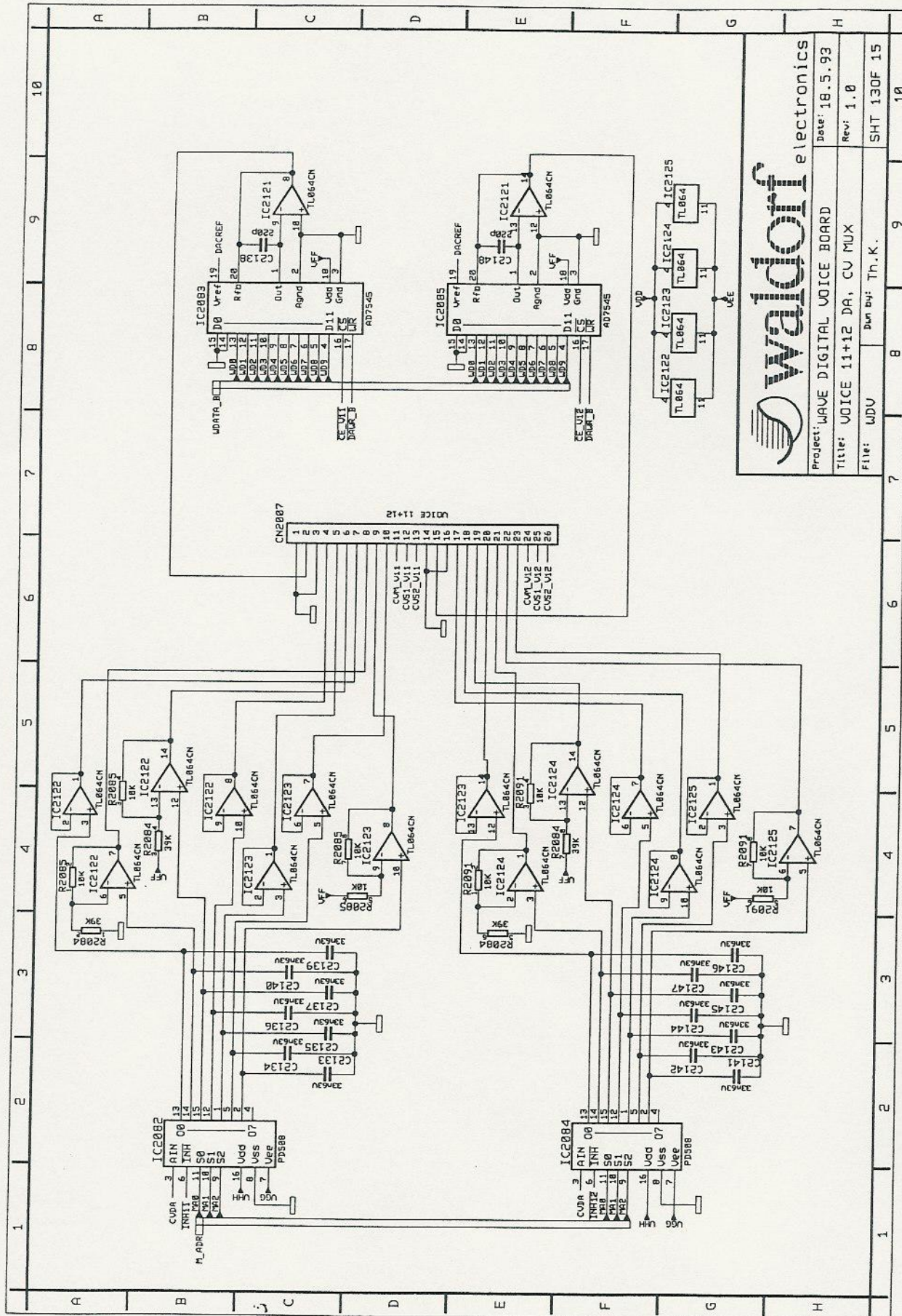

Project: WAVE DIGITAL VOICE BOARD  
 Date: 18.5.93  
 Title: VOICE 11+12 DA, CV MUX  
 Rev: 1.0  
 File: WDV  
 Des By: Th.K.  
 SHT 130F 15



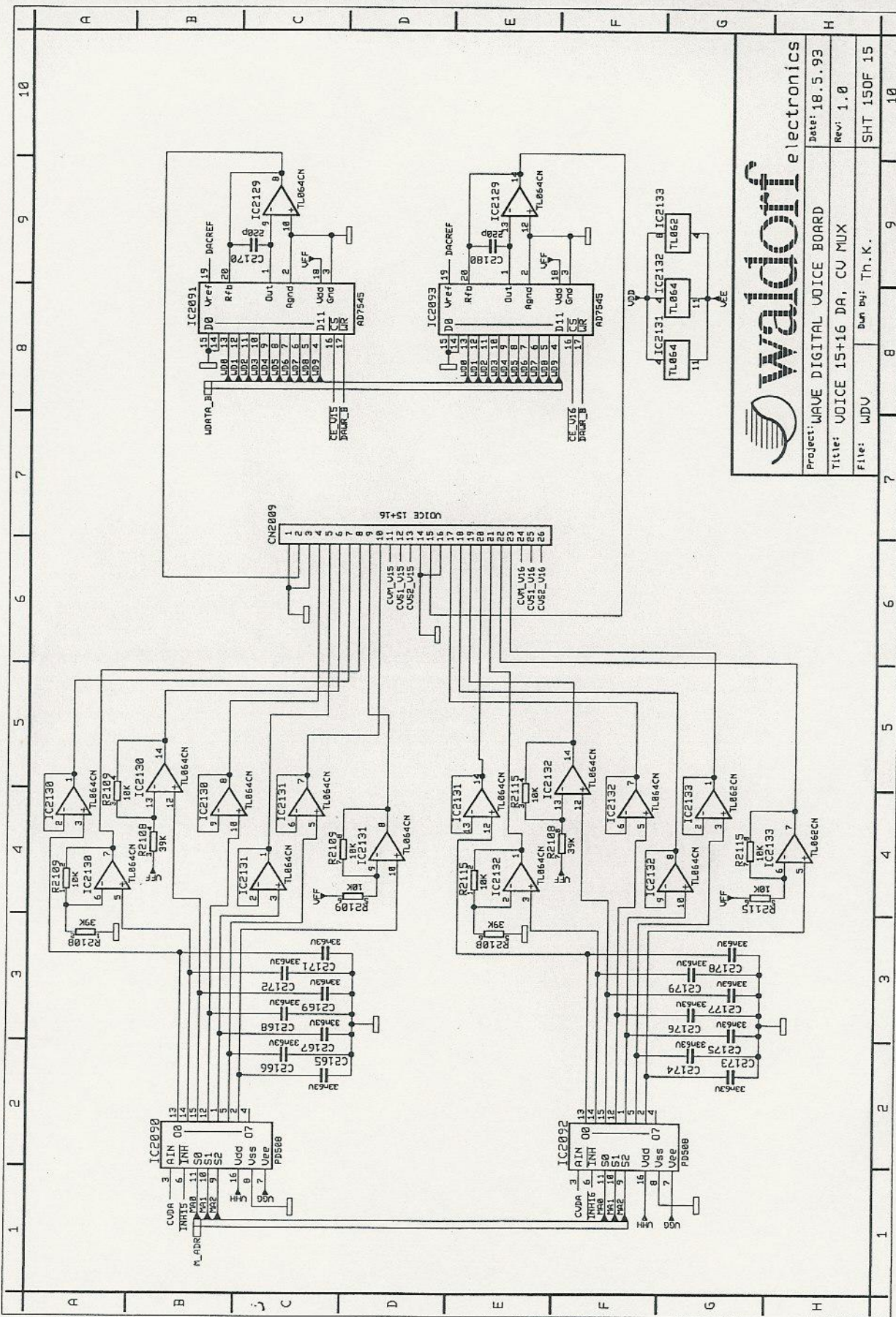

**waldorf** electronics

Project: WAVE DIGITAL VOICE BOARD      Date: 18.5.93  
 Title: VOICE 15+16 DA, CU MUX      Rev: 1.0  
 File: WDV      Drawn by: Th.K.      SHT 150F 15

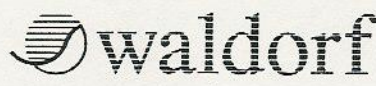







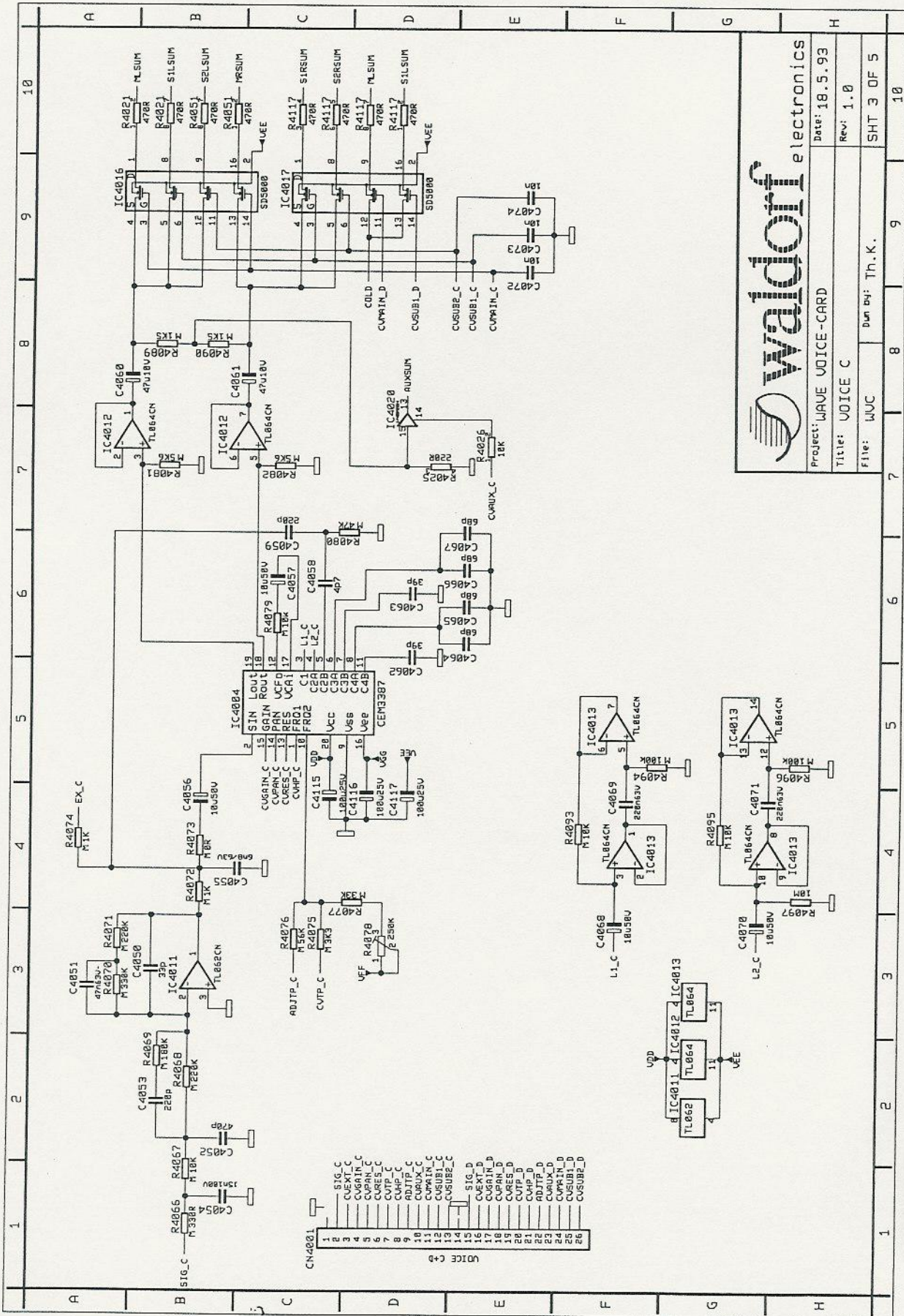

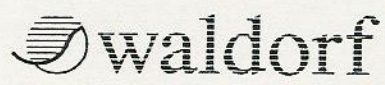

**waldorf** electronics

Project: WAVE VOICE-CARD Date: 10.5.93  
 Title: VOICE C Rev: 1.0  
 File: WUC Dun by: Th.K. SHT 3 OF 5

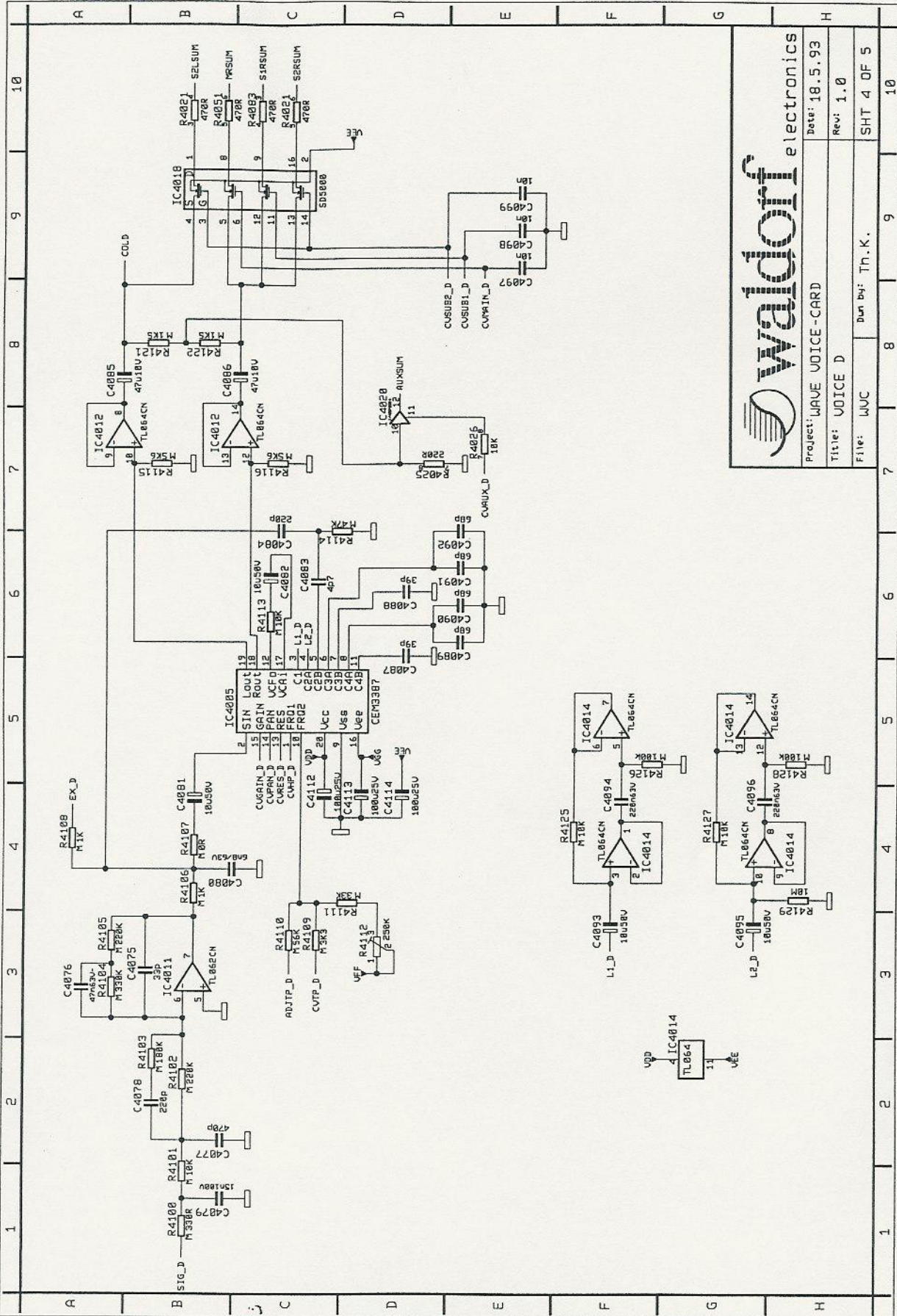





**waldorf** electronics

Project: WAVE VOICE - CARD	Date: 18.5.93
Title: VOICE D	Rev: 1.0
File: WUC	Drawn by: Th.K.
SHT 4 OF 5	

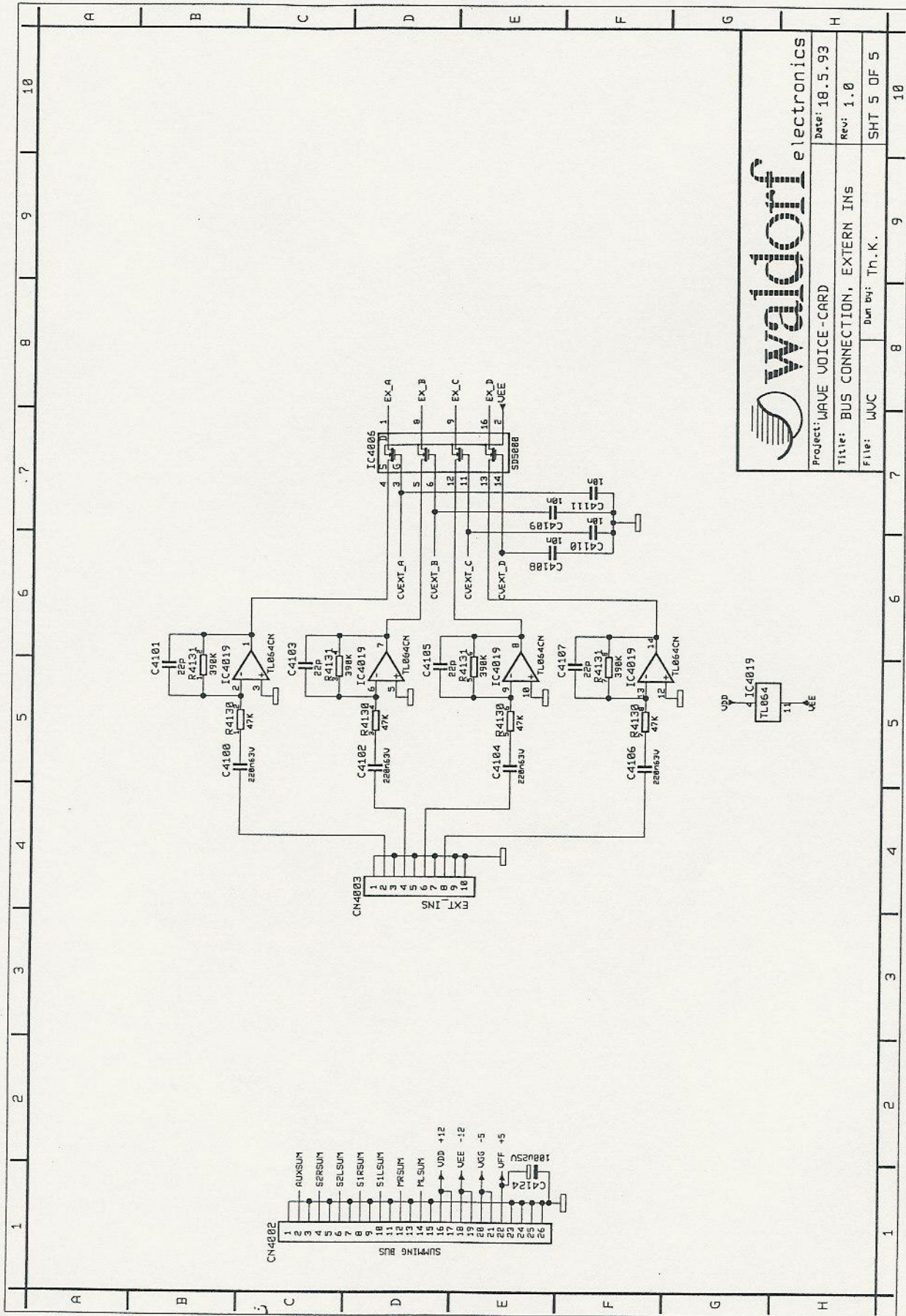

**waldorf** electronics

Project: WAVE VOICE-CARD      Date: 18.5.93  
 Title: BUS CONNECTION, EXTERN INS      Rev: 1.0  
 File: WUC      Drawn by: Th.K.      SHT 5 OF 5



# Appendix

---

## Special MIDI cable for CPU Board I/O Check

The MIDI cable for CPU Board I/O Check is simply a MIDI cable with one MIDI connector on one and two MIDI connectors on the other side.

Date: April 7th 1995

Version: 1.640

## Waldorf Wave MIDI Implementation Chart

Function		Transmitted	Recognized	Remarks
Basic Channel	Default Changed	1 1 - 16	1 1 - 16	
Mode	Default Messages Altered	x x	2 x x	No Modes supported
Note Number	True Voice	0 - 127	0 - 127 0 - 108	
Velocity	Note ON Note OFF	o o	o o	
After Touch	Key's Ch, s	x o	o o	
Pitch Bender		o	o	
Control Change	0 1 7 10 64 0 - 120	o o o o o o	o o o o o o	Bank Switch Mod. Wheel Main Volume Panning Sustain Pedal Assignable to Buttons, Faders and Free Wheel
Program Change	True #	o	o 0 - 127	P.-Change via Editable Maps
System Exclusive		o	o	
System Common	Song Pos. Song Sel. Tune	x x x	x x x	
System	Clocks	x	o	Clock usable as modulator
Real time	Commands	x	x	
Aux Mes- sages	Local ON/OFF All Notes Off Active Sense Reset	x o o x	x o o x	selectable
Notes		Supports MIDI Tuning Standard		

Mode 1: OMNI ON, POLY  
Mode 2: OMNI OFF, POLY

Mode 3: OMNI ON, MONO  
Mode 4: OMNI OFF, MONO

o : Yes  
x : No





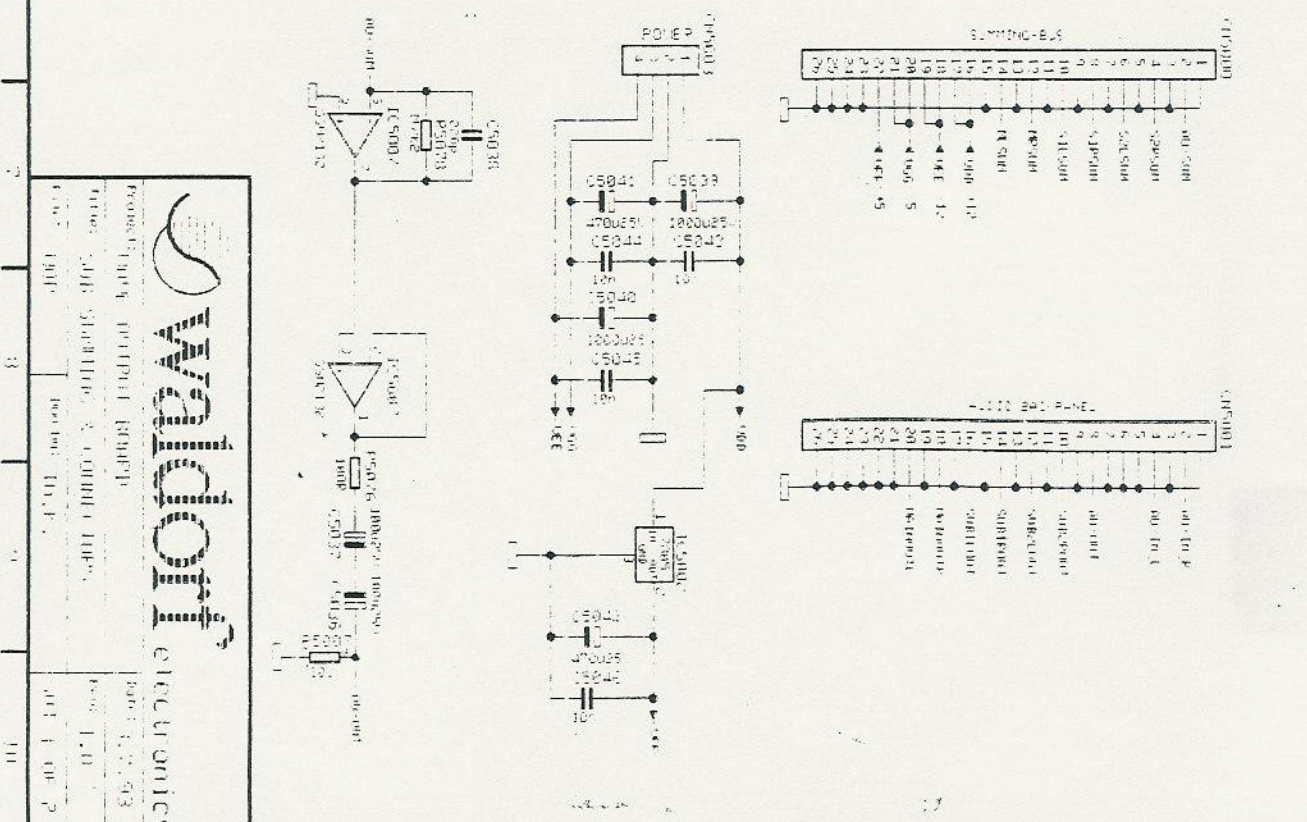
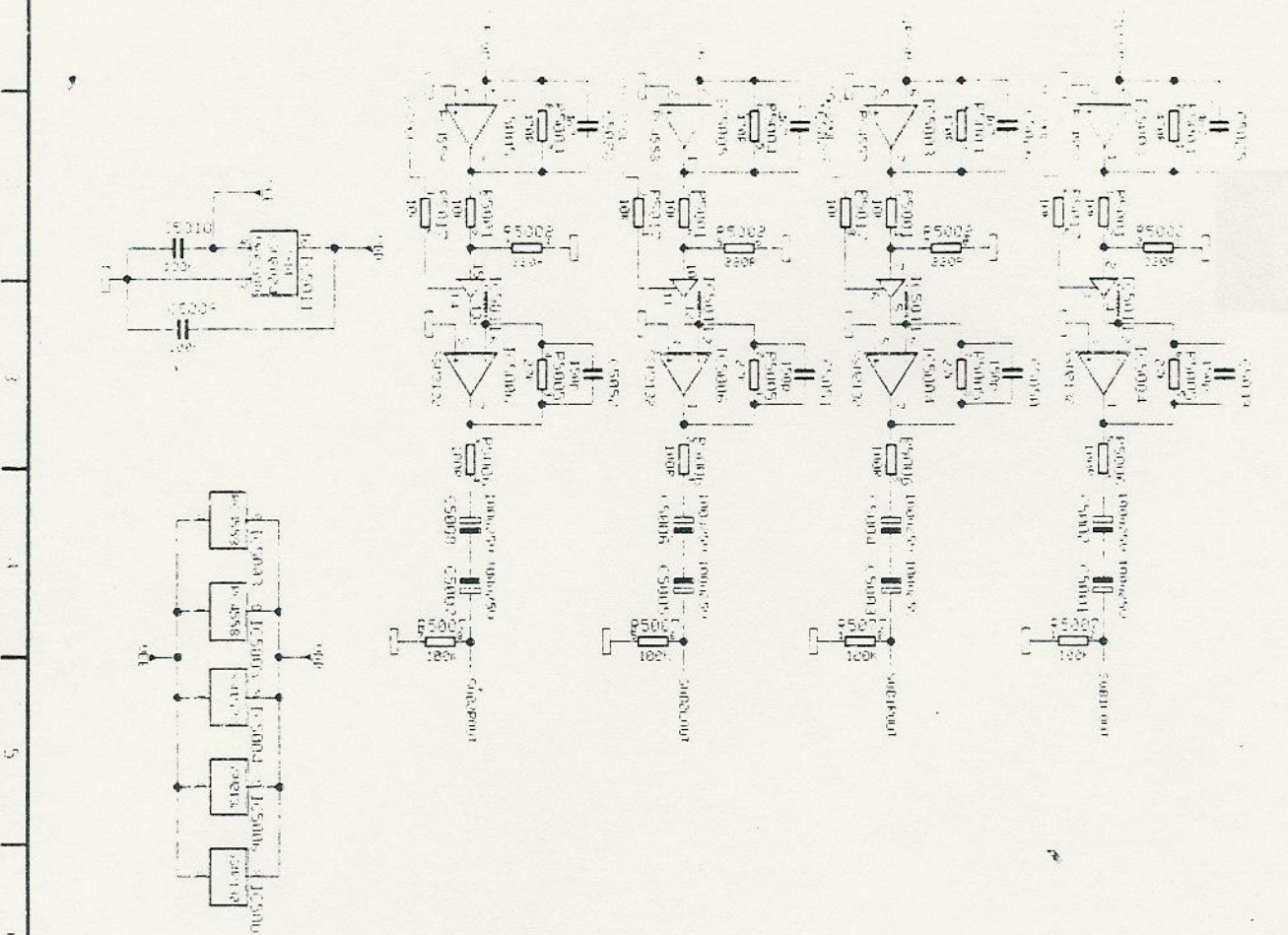





**Waldorf**  
ELECTRONICS

Project: 1904 - 401 Pin IC (8000 P)

Notes: 2016 Stack-Up, 2 x 0.0100 (100P)

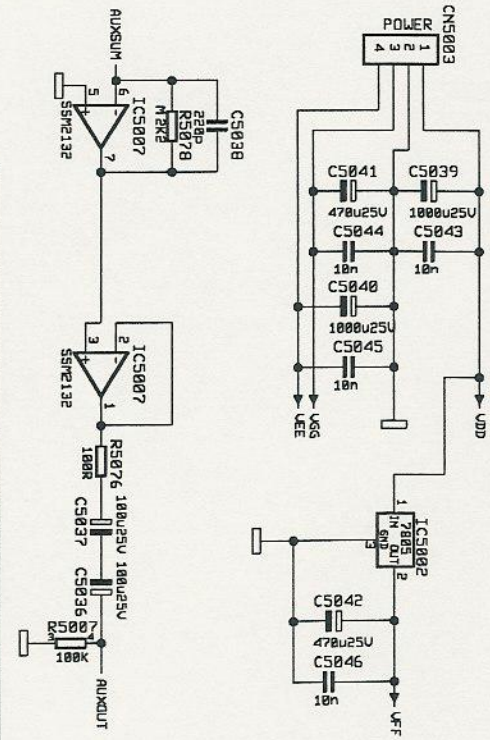
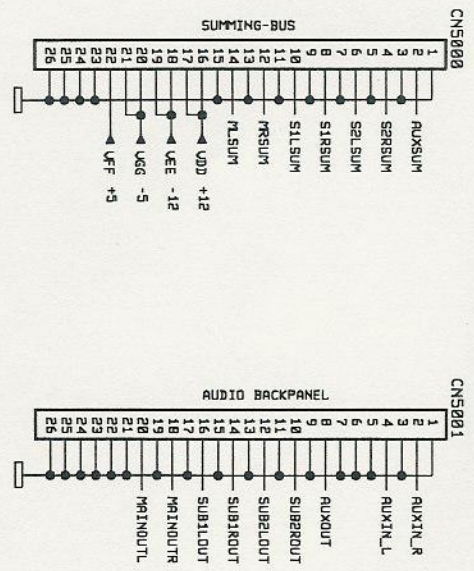
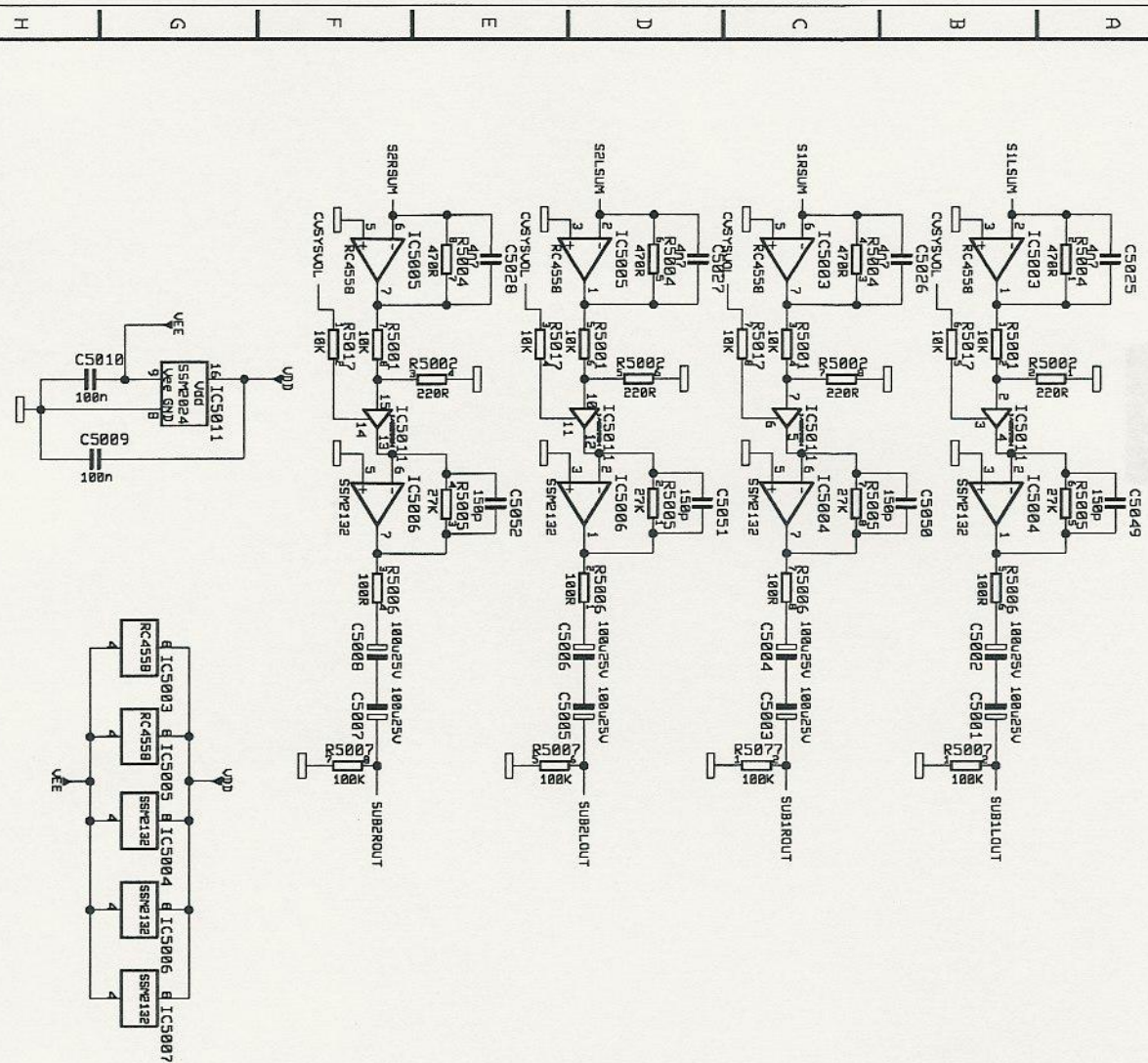
Scale: 1:100      Board: 10.4" x 10.4"      Rev: 1.0      Date: 10/1/83





  
**Waldorf** electronics

Project: WAVE OUTPUT BOARD		Date: 3.7.93
Title: SUB-SUMMING & CONNECTORS		Rev: 1.0
File: WQP	Des by: Th.K.	SHT 1 OF 2

INFO  
 Proj. File Name: WQP  
 Datum: 12.12.94  
 Letterpl.-Preis:

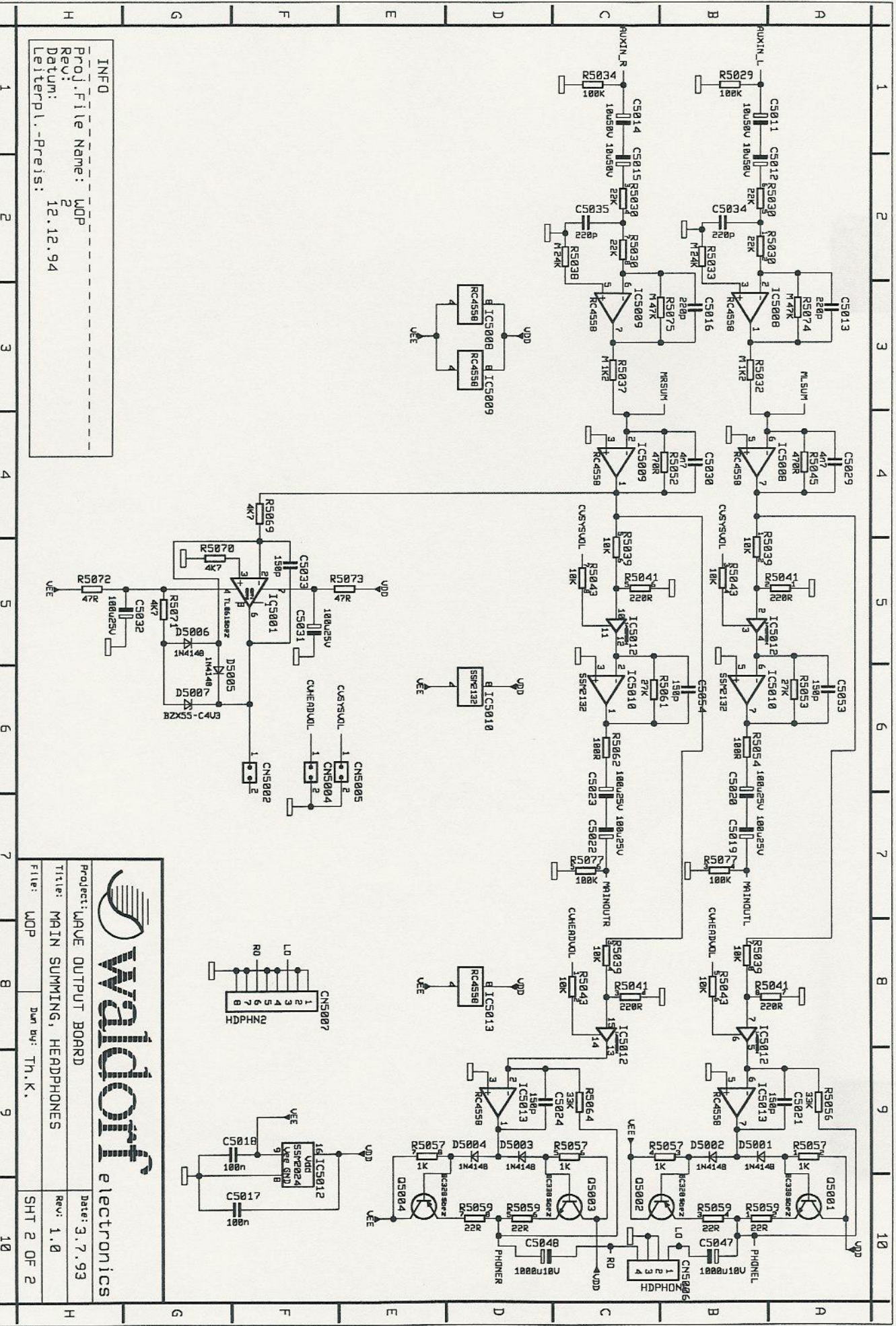
  
 Project: WAVE OUTPUT BOARD  
 Title: MAIN SUMMING, HEADPHONES  
 Date: 3.7.93  
 File: WQP  
 Drawn by: Th.K.  
 Rev: 1.0  
 SHT 2 OF 2



1 2 3 4 5 6 7 8 9 10

A B C D E F G H

Bestückungsplan WOP Rev.2 12.12.94

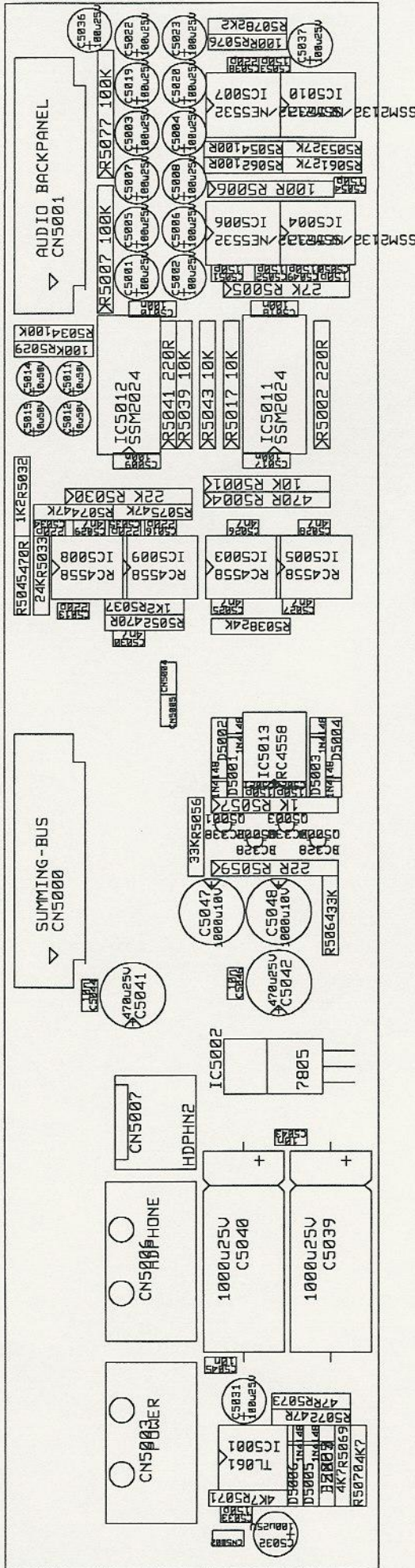



<< 13

>> 76

□ 77

> 84

o 80

in 81

out 82

shift 83

Edit Numf 67

Edit NumEvn 66

Edit Penning 61

Edit F.HER 60

Type 43

Select 75

Edit FILTER 59

S/B

IC

<<	13	3013	28	5att 6
>>	76	3076	93	
□	77	3077	92	
>	84	3099	69	-
0	80	3095	65	Control Delay / 5%TH
	81	3096	64	Control Mixer / Comp
in	81	3096	64	
out	82	3077	67	Ampl Edit
shift	83	3098	66	Ampl Env Edit

Edit Amp 67  
 Edit Am Env 66  
 Edit Panning 61  
 Edit Filter 60  
 Type 43  
 Select 75  
 Edit Filter Env 59

connectors

9 25	9 25
10 25	10 25
11 27	11 27
12 25	12 25
13 20	13 20
14 27	14 27
15 31	15 31
16 30	16 30

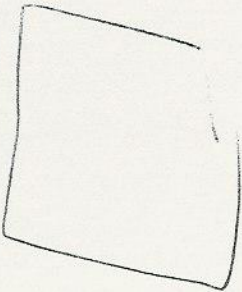



# Musitek

SERVICES

Electronic Repairs for the Entertainment Industry

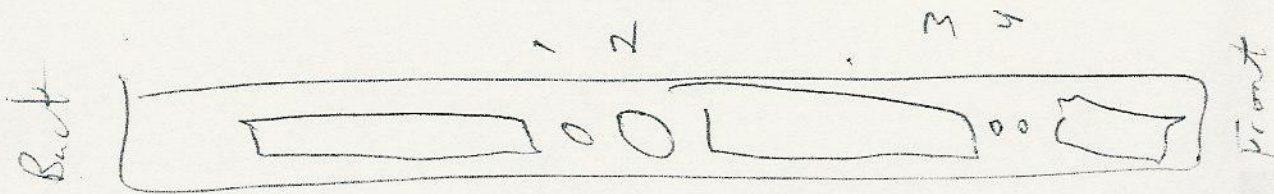

x=remove

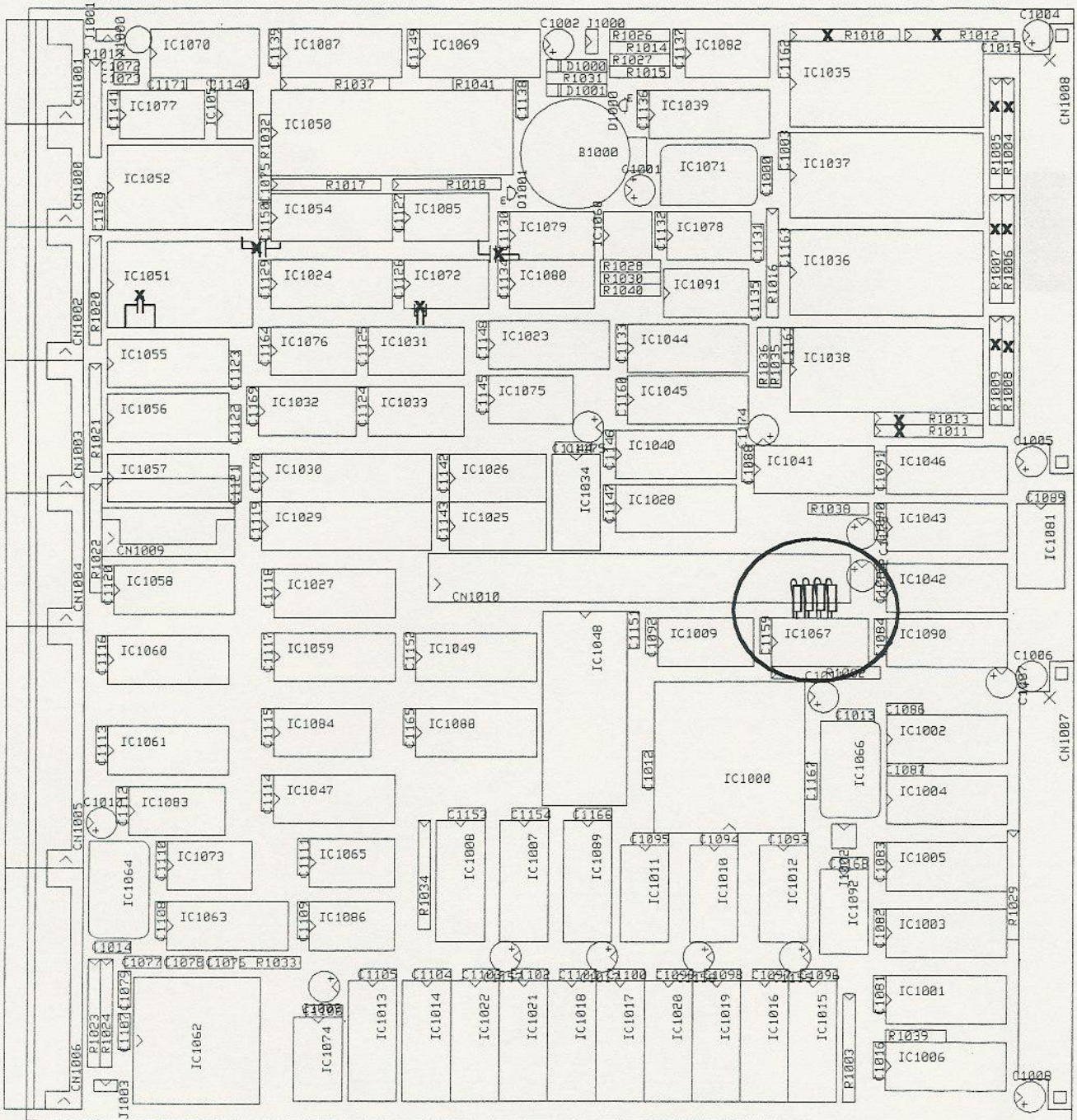



## TECHNICAL INFORMATION OF CHANGE

**PROJECT:** WAVE  
**TIOC #:** 7 / 970630  
**ATTACH TO DOCU:** REV1.0 / 1.1  
**PCB REV:** REV1  
**COMPONENT LAYOUT:** REV1.1

**CHANGED BY:** Th. Kircher

**SUBJECT:** Improvement of System Stability  
**No. of Pages:** 2

---

The following changes should be made on all Waves coming into service.  
The subject to change is the master clock generator on the CPU-Board (W2CPU schematics page 8).

- I) IC1067 must be a LS type (74LS163A) as stated in the schematics
- II) Connect resistors (47 Ohms, 1/8W) in series to the outputs of the LS163 (pin 11, 12, 13, 14) to reduce the reflections on the clock lines. Lift the four pins of the IC out of the PCB and solder the resistors between PCB and IC pins.
- III) On the component side of the PCB there are some caps soldered to IC pins. Remove them all.
- IV) Remove Resistor Packs :
  - R1004
  - R1005
  - R1006
  - R1007
  - R1008
  - R1009
  - R1010
  - R1011
  - R1012
  - R1013

Component locations are marked on the following component layout: