

MODEL 120

WURLITZER ELECTRONIC PIANO SERVICE MANUAL

**PLEASE INSERT THIS IN THE BACK OF YOUR
PRESENT WURLITZER ELECTRONIC PIANO
SERVICE MANUAL**

MODEL 120

WURLITZER ELECTRONIC PIANO SERVICE MANUAL SUPPLEMENT

Introduction

Since the Wurlitzer Electronic Piano was introduced in 1954, our Engineering Department has spent a great amount of time striving to improve this new instrument and incorporate into it suggestions received from our dealer organization.

As a result, we are pleased to present the new Model 120 which is lighter weight, smaller, more attractive and contains a number of other improvements over former models.

This Service Manual has been written to serve as a guide in the proper servicing of this instrument. The manual is of loose leaf construction so that it can be inserted in the cover of the Electronic Piano Service Manual.

The pages and illustrations in this supplement all have "120" as the prefix so as to avoid confusion with the Model 112 section.

In order to avoid repetition and to keep the Service Manual compact when items referring to the Model 120 are the same as those which apply to the Model 112 or a Conventional Wurlitzer Piano, there will be a reference to certain pages of those manuals.



Fig. 120-A

SPECIFICATIONS OF THE WURLITZER ELECTRONIC PIANO MODEL 120

Width	- 39"	110 Volts, A.C.
Depth	- 18 13/16"	60 Cycle
Height	- 7"	AC Wattage Consumption: 60

SPECIFICATIONS FOR BENCH FOR WURLITZER ELECTRONIC PIANO
MODEL 120

Height	- 19 1/2"
Width	- 13"
Length	- 22"

PREPARATION OF THE MODEL 120 WURLITZER ELECTRONIC PIANO
FOR SALE

See Page 2 of Model 112 section of the Service Manual.

1. Unpack and check as outlined on Page 2 of the Electronic Piano Service Manual.
2. Sometimes, during shipment, dirt and foreign materials become lodged between the reeds and the pickups causing noisy amplification. It can be easily corrected in the following manner:
 - a. First turn the volume completely down. Starting from the bass end, strike each key, with a normal blow, three (3) times. It may be necessary to repeat this procedure several times.
 - b. If this does not take care of the noise, please refer to the Electronic Piano Service Manual, Page 7, under Tone Producing Principle and familiarize yourself with the contents. Remove the eleven screws in the top (Fig. 120-F) and remove the top of the piano. Now refer to Page 120-9, Fig. 120-I. Place a piece of white paper between the hammer (25) and the reed (26) and turn a flashlight on the paper. This enables you to see any foreign material that may still be on the reed or pickup (9). You may find that the reed is "off center" which will show up by having more light on one side than the other. This latter condition can be corrected by loosening the reed screw and re-centering the reed. Be sure the reed screw is firmly tightened after the reed has been centered.

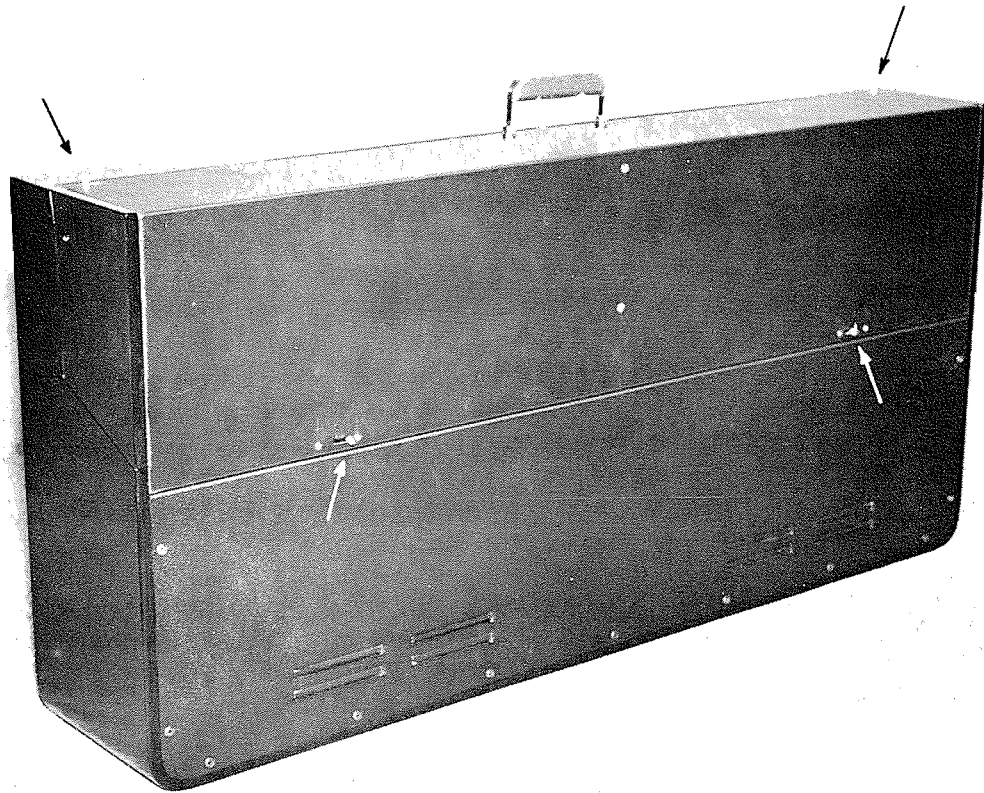

Fig. 120-B

REMOVING THE FALL COVER

The fall cover is fastened to the case by means of four (4) spring-loaded catches, indicated by arrows in Fig. 120-B. Two of these catches are on top of the fall cover and snap into the outer ends of the mounts which support the music panel. The other two catches are on the front of the fall cover and snap into the strikes located on the inside of each rim arm just above the keyclip. See Figs. 120-A, B, C, D, E & F.

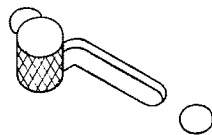

Fig. 120-C

UNLOCKED

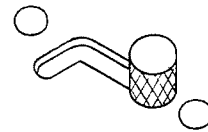

Fig. 120-D

LOCKED

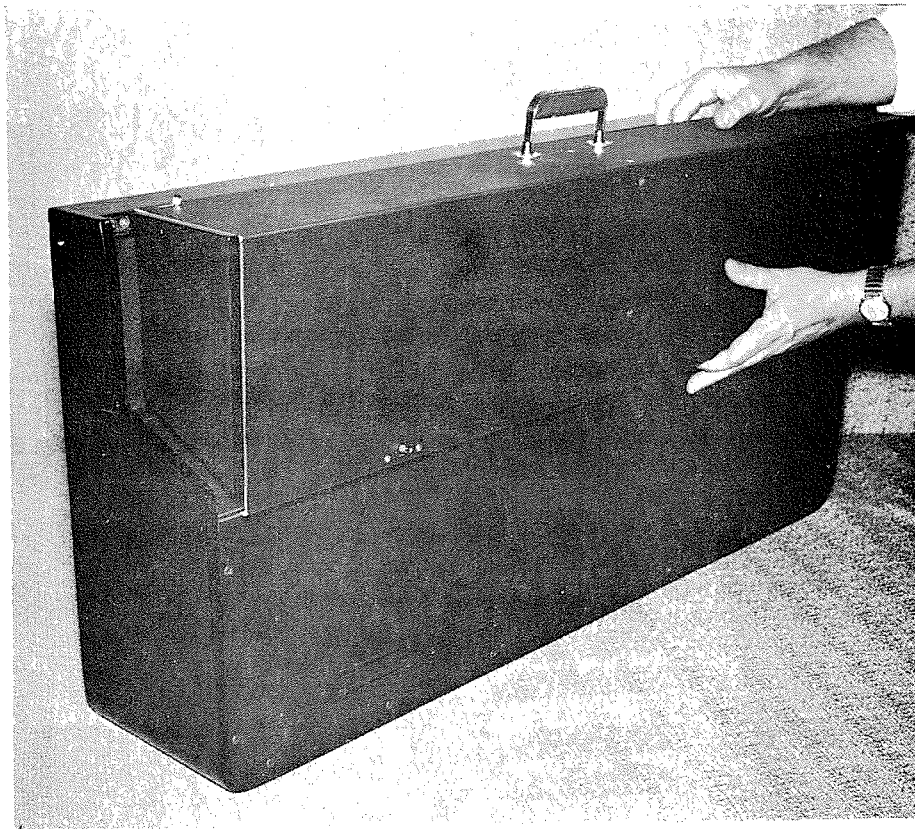

Fig. 120-E

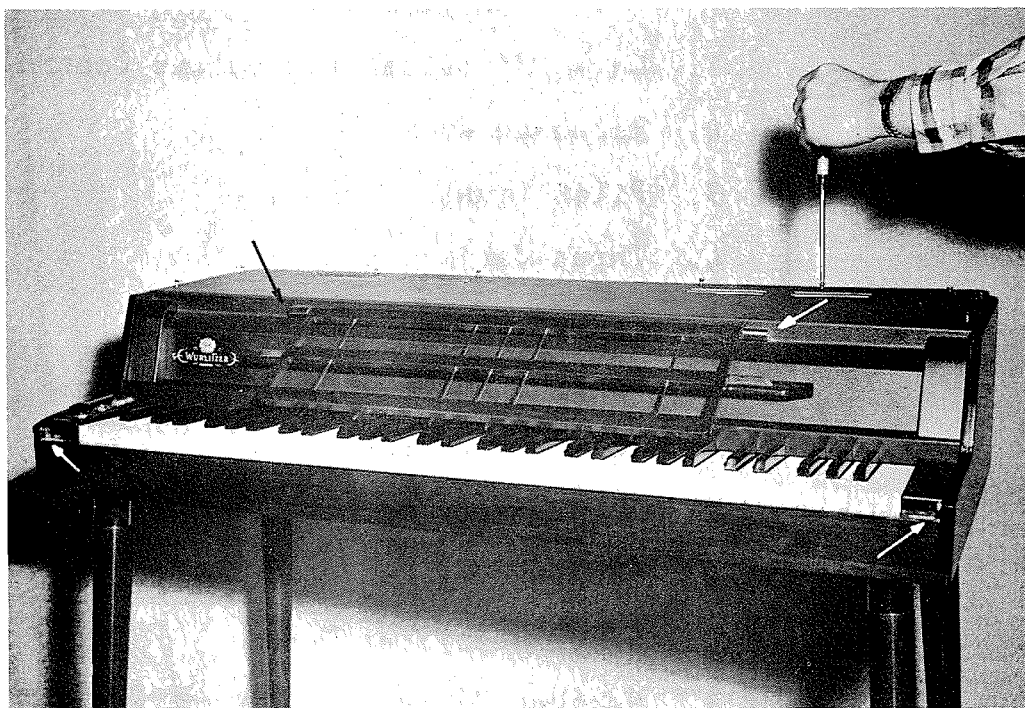

Fig. 120-F

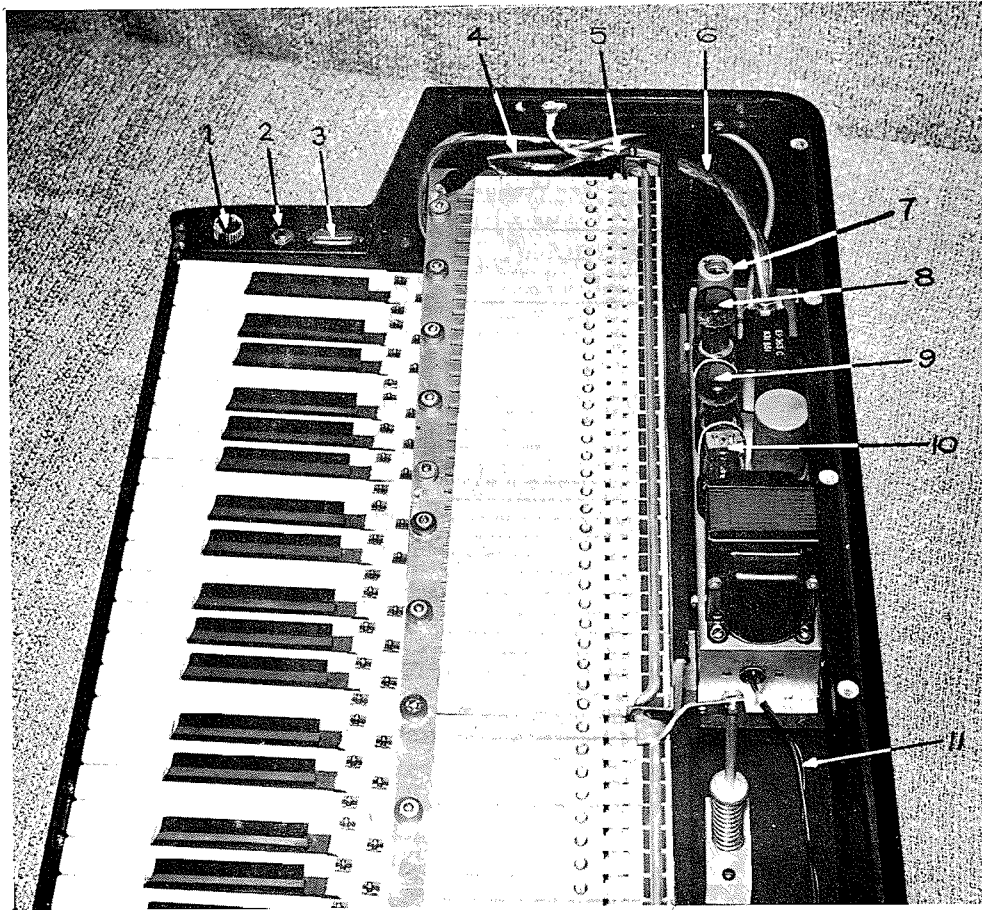

Fig. 120-G

1. On - Off Switch and Volume Control
2. Earphone Jack
3. Pilot Light
4. Input Cable
5. Ground Cable
6. Control Panel Cable
7. 12AX7 Input Tube
8. 6V6GT Power Output Tube
9. 6V6GT Power Output Tube
10. 5Y3GT Rectifier Tube
11. Speaker Cable

CHECKING THE AMPLIFICATION SYSTEM

1. Remove the fall cover. (See Fig. 120-E.)
2. Remove screws from the top and lift top from case. (See Fig. 120-F.)
3. Inspect amplifier to see if all the tubes are mounted securely in their sockets. These tubes are standard types and should be available locally if replacement is ever necessary. (Location of tubes shown in Figures 120-G and 120-R.)
4. Check to see that the following cables are plugged in tightly as shown in Figure 120-G.
 - a. Piano input cable.
 - b. Control panel cable.
 - c. Speaker cable.
5. Fuse: Check 1 amp fuse (Slo-Blo) as shown in Figure 120-H and 120-R.
6. A.C. cord: This cord is a one-piece molded line cord that fits the receptacle on the back of the case as shown in Fig. 120-H.

WARNING! This instrument operates only on 110 Volts, 60 Cycle.
7. Switch and volume control: The line switch is on the keyblock control panel located in the left key block. When the knob is turned counter clockwise as far as possible, it is in the "off" position. Rotating the knob clockwise turns the amplifier on and the pilot light will glow. The amplifier is at full volume when this knob is turned to the extreme clockwise position.
8. The pilot lamp, located on the left keyblock, is Neon and should last indefinitely. It is a normal characteristic of this type lamp to light up and go out rather slowly.

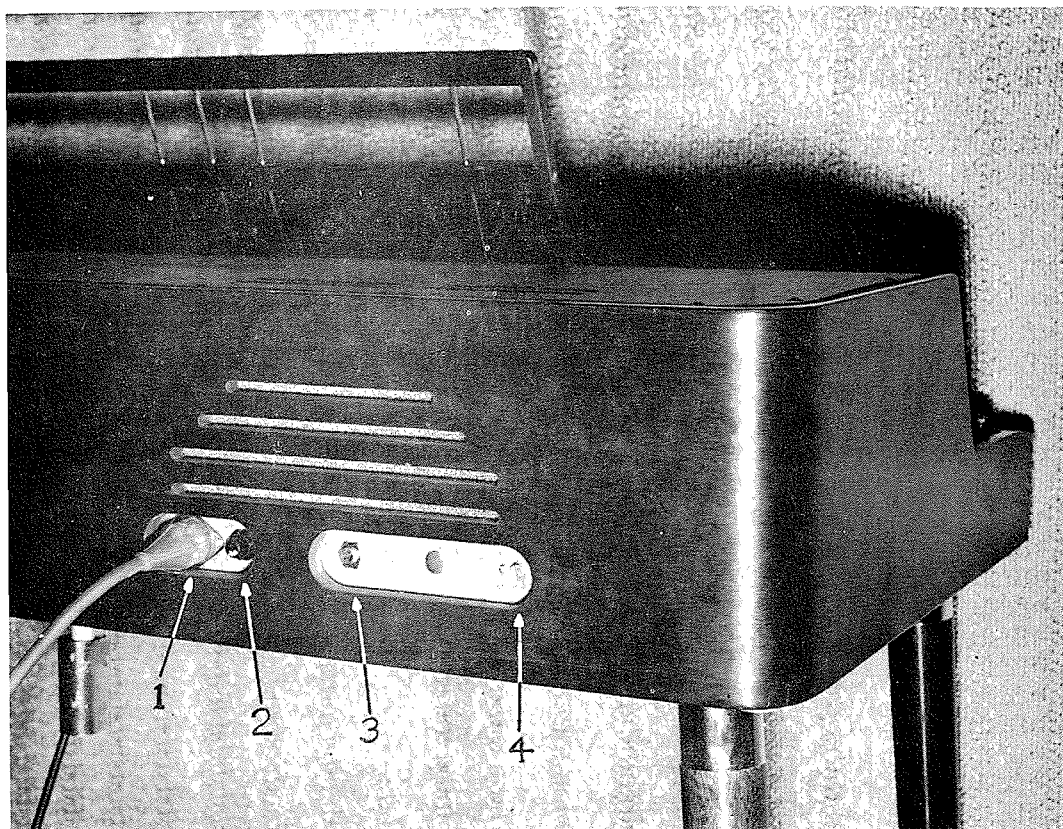

Fig. 120-H

- | | |
|-------------------------|--------------------------|
| 1. Line Cord Receptacle | 3. External Speaker Jack |
| 2. 1 Amp Slo-Blo Fuse | 4. Record Player Input |

TONE PRODUCING PRINCIPLE

See diagram and explanation on Page 7 of Model 112 section.

CHECKING THE BAR AND REEDS

The reed bar in the Electronic Piano must float freely on the two rubber washers located at each end of the bar. Be sure the two large bar mounting screws on each end are NOT screwed down tight against the rubber washers. There should be at least $1/64$ " space between the head of the screws and the rubber washers. (See Fig. 120-J.)

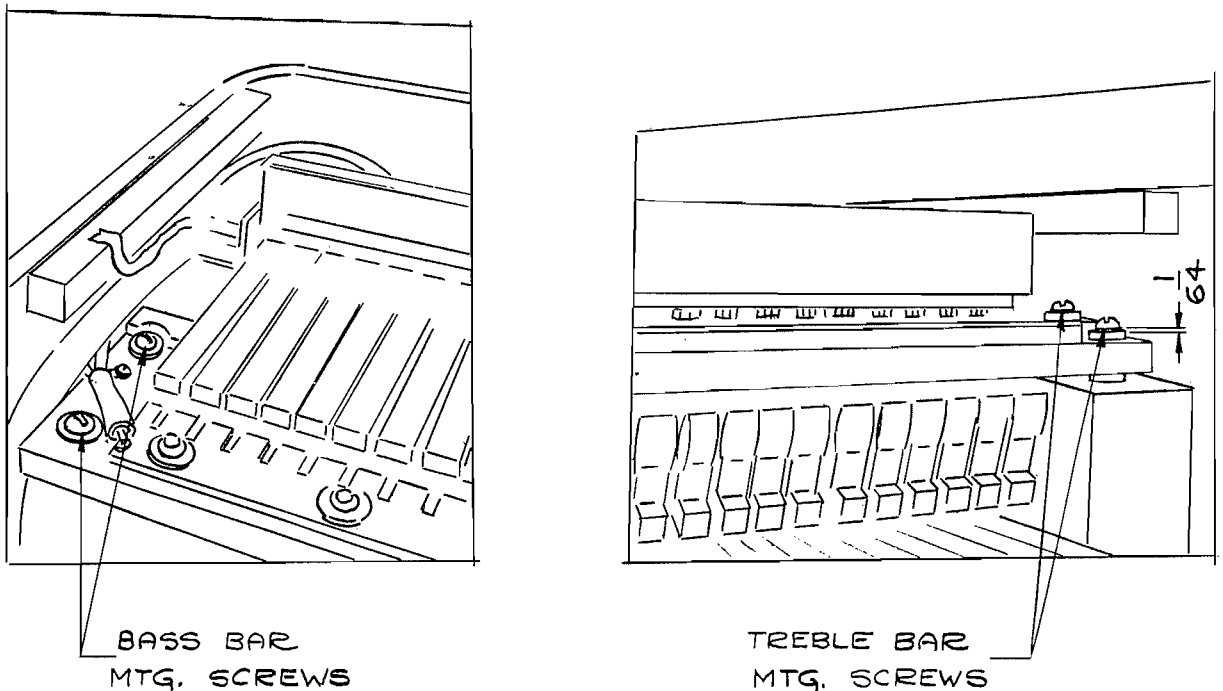

Fig. 120-J

IMPORTANT - A new scale of reed dimensions has been incorporated into the Model 120; therefore, all of the reeds are not interchangeable with reeds of former models. For further instruction see Page 120-17.

KEY AND ACTION REGULATION

Like the conventional piano, the regulation of the keys and action is very important and should only be undertaken by a tuner-technician or a trained service man.

In the event excessive moisture in the air causes sluggish keys or action centers, they should be corrected according to the instructions given in the Wurlitzer Piano Service Manual. "Ease Keys" is described on Pages 4 and 7 and "Shrinking Action Centers" is explained on Pages 12 and 16 of that manual. Before shrinking action centers, turn the instrument on for several hours. The heat from the amplifier may dry out the action sufficiently to make shrinking unnecessary.

REGULATING PROCEDURE

1. LEVEL AND EASE KEYS

If key leveling is necessary, it can be done by removing or adding paper punchings under the felt washers on the balance rail. (See Page 11 of Model 112 section.)

2. KEY DEPTH

The proper key depth is $13/32$ " measured at the front of the white keys. If the key height is correct and the key depth is shallow, it may be increased by removing material from the bottom of the front of the white key. If the key depth is too deep, paper punchings of the required thickness may be glued to the bottom surface of the front of the key.

NOTE - It is best to wait until the hammer let-off has been adjusted before setting the key depth of the sharps.

If all the keys have a shallow depth, it may be better to build up the balance rail either with paper punchings under the keys, or shims under the balance rail.

3. ADJUST CAPSTAN SCREWS (See Fig. 120-K.)

The capstan screws are adjusted so there is $3\ 13/16$ " from the bottom of the key frame to the tips of the hammers. The hammer tip line will be even when capstan screws are properly adjusted. They are not at the point of lost motion as was the case in the Model 112.

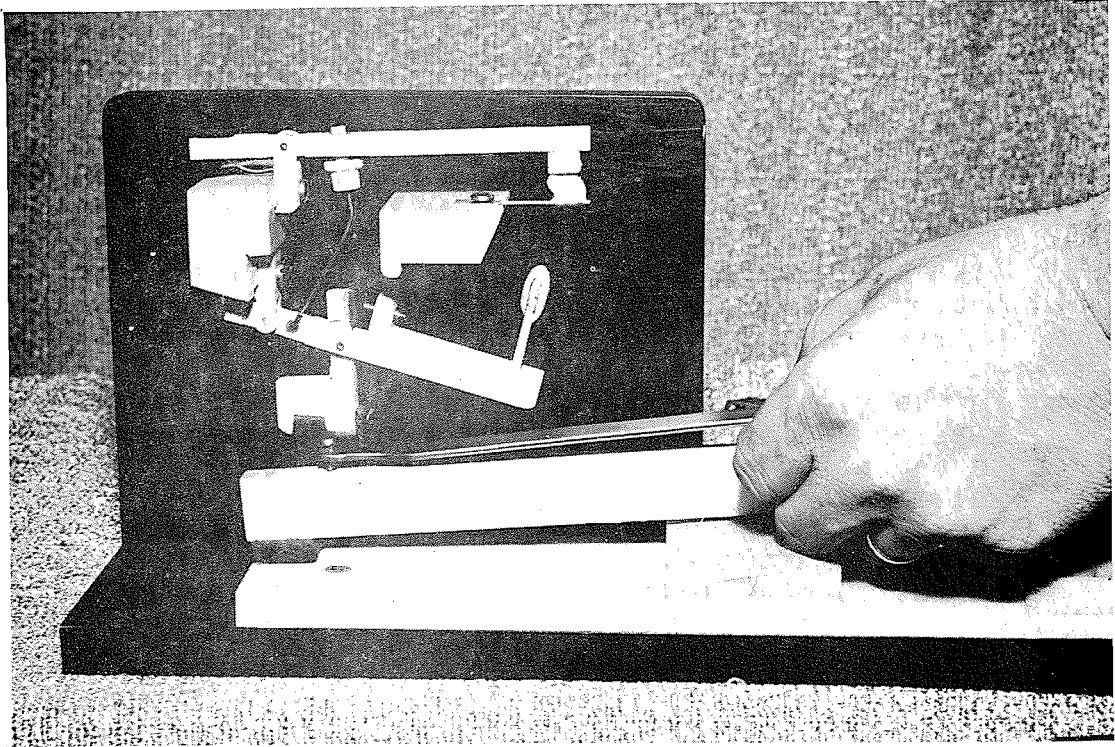

Fig. 120-K Adjusting Capstan Screw

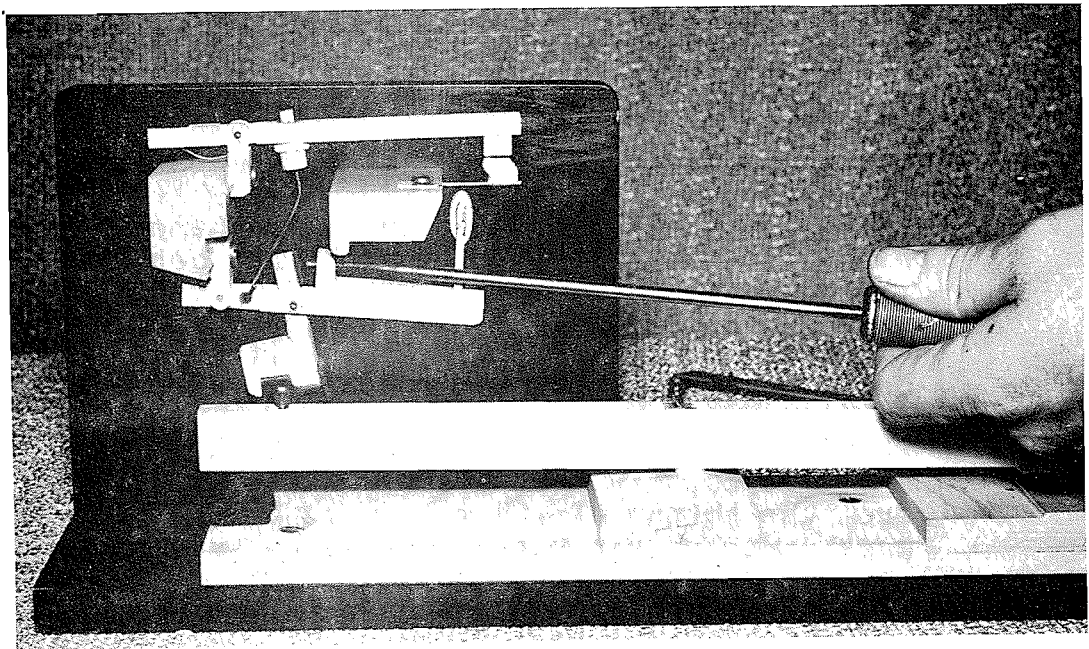

Fig. 120-L Adjusting Let-Off Screw

4. LET-OFF ADJUSTMENT (See Fig. 120-L.)

The hammer should let off $1/16$ " from the reed in the treble and $1/8$ " in the bass. This is the ideal adjustment for a light touch.

IMPORTANT: Experience has proven the felts will pack on a new instrument, so the factory is setting the let-off $1/16$ " greater than the figures in the above paragraph.

This allows about $1/32$ " after-touch or movement of the key after the hammer lets off. The let-off is adjusted by the regulating screw as shown in Fig. 120-L.

NOTE: The let-off screwdriver used for regulation is equivalent to item #4102 (Page 23) in Schaff Piano Supplies Catalog.

If the screw is turned clockwise too far, it will cause the hammer to let off too soon and the piano will not function properly with a light touch. Also, excessive after-touch will occur. If the screw is turned counterclockwise too far, the hammer will not let off and will block against the reed. This results in little or no after touch.

If some of the notes have excess after-touch, the hammer will let-off, check back and then rise high enough to block on the reed. This can be corrected by gluing one half ($1/2$) of a paper front rail punching of the desired thickness to the bottom of the front of the white key.

NOTE: If the whole action is this way, check paragraph on key depth (paragraph 2) and capstan screws (#3) before proceeding.

5. ADJUSTING SHARPS

The key depth and after-touch of the sharps are adjusted by the screw under the front of each sharp. Turning this screw clockwise allows greater key depth and after touch; turning it counterclockwise allows less key depth and less after-touch.

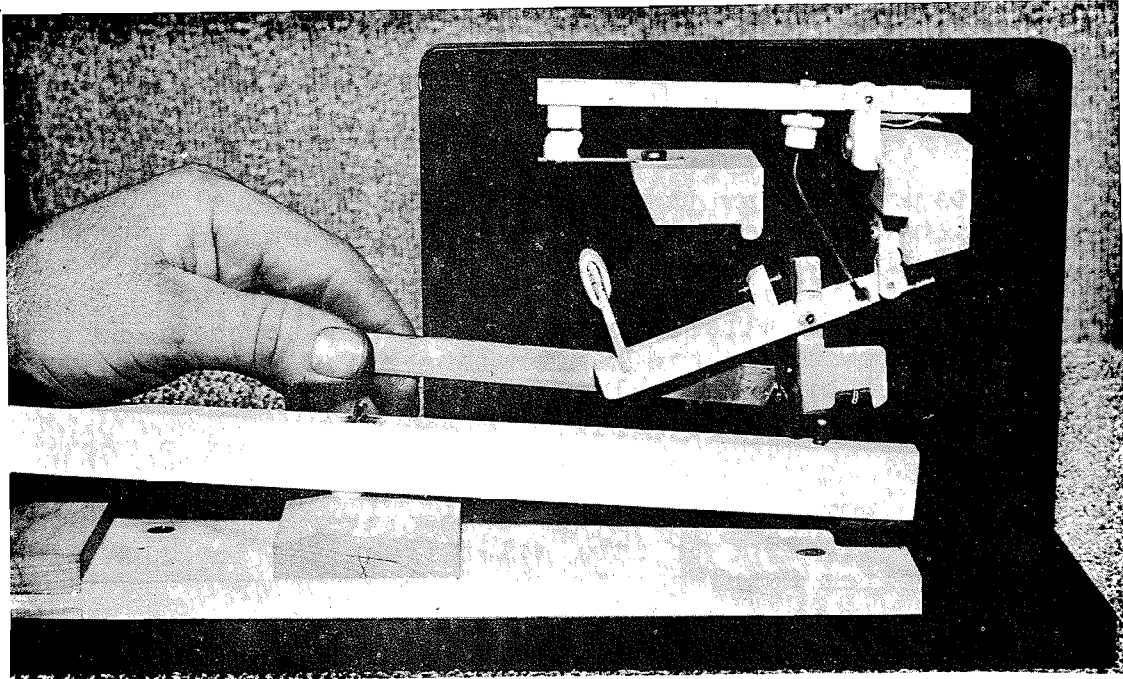

Fig. 120-M Adjusting Spoon

6. SPOON ADJUSTMENT (Fig. 120-M.)

The butt spoon (Item 32, Fig. 120-I) has been factory-set and should not require adjustment. The spoon is bent out just far enough so the capstan screw (Item 36; Fig. 120-I.) will escape to the fly leather. (Item 37, Fig. 120-I.).

The proper setting of the butt spoon is when the spoon clears the fly stop cloth (Item 35, Fig. 120-I.) by $\frac{1}{64}$ " after the key is fully depressed and let-off has been obtained. Proper or full check back will result.

Improper setting of the fly spoon is when the spoon does not clear the fly stop cloth after the key is fully depressed. Full check back will not result and the capstan screw will not bottom on the fly leather.

NOTE: A small circular mirror with a handle, such as dentists use is handy for checking spoon regulation and can generally be purchased from radio supply houses.

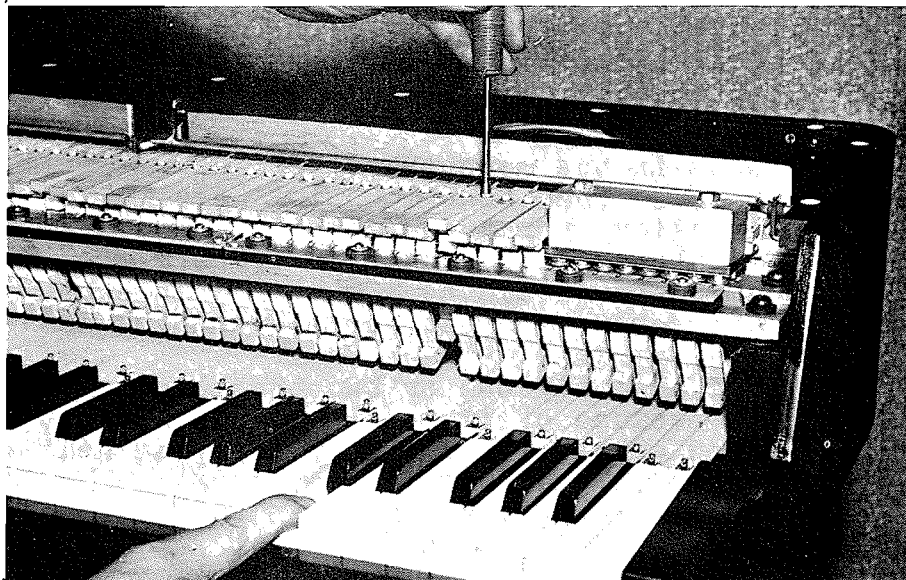

Fig. 120-N Damper Adjustment

7. DAMPER ADJUSTMENT

The dampers are adjusted by the damper lever lift dowel which protrudes through the damper levers. See Fig. 120-N. When the key is fully depressed, the damper should be lifted $\frac{3}{16}$ " from the reed. Turning the slotted dowel counterclockwise causes the damper to be lifted higher.

TONE REGULATING (OR VOICING)

Tone regulating of the Wurlitzer Electronic Piano is accomplished in the same manner as in a conventional piano and should only be done by a tuner-technician.

STRIKING POINT

The striking point of the hammers to the bar is very important just as it is in a conventional piano. The striking point is properly set at the factory and should require little or no adjustment in the field.

In the event the striking point does need adjustment, it is more likely to be in the treble. If some of the treble notes sound "dead" or "woody," first check to be sure the two large bar mounting screws are not down tight against the rubber mounting washers. Then remove the rear large screw and loosen the front one. Turn the instrument on and while striking the treble keys move the treble end of the bar slightly forward and backward until the maximum volume and desired tone is reached. If this location of the bar is such that the rear screw hole in the bar mounting block does not coincide with the center of the rear mounting hole in the bar, plug the

original hole in the mounting block and re-drill a hole for the rear screw. The front mounting hole in the bar is slotted and allows for adjustment. Before putting screws in, be sure the proper washers or spacers are in place. Also remember there should be 1/64" clearance between the heads of the screws and the rubber mounting washers.

If there are only one or two treble notes that do not sound right because of improper striking point, the hammers can be burned either in or out by applying heat with a soldering iron to the shank or moulding of the hammer and at the same time forcing the hammer in the desired direction. See Fig. 120-0.

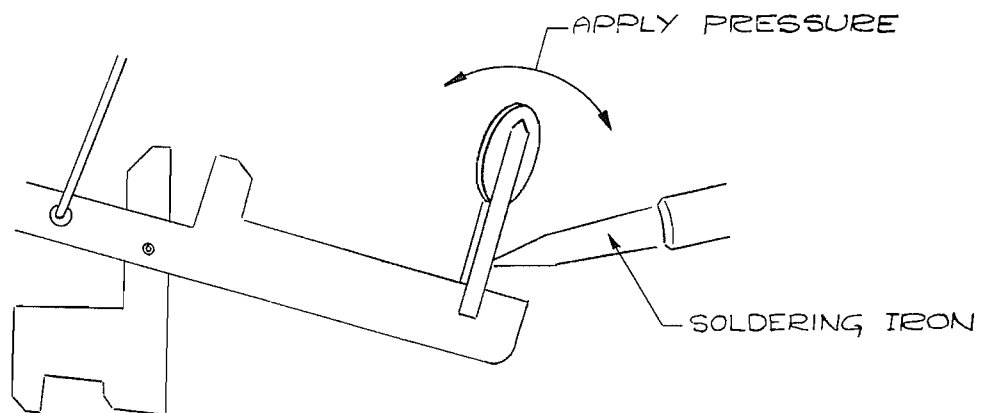

Fig. 120-0 (Burning Hammers)

BLOCKING HAMMERS

Blocking hammers can be caused by either one of four things or a combination of them:

- a. Improper capstan screw adjustment.
- b. Improper regulating screw adjustment.
- c. Excessive key depth.
- d. Excessive after touch.

TONES NOT PRODUCED BY A LIGHT TOUCH

This condition is caused by hammers letting off too quickly or too far from the reeds.

ADJUSTING AND CHECKING REEDS

See Page 12 of the Model #112 Service Manual. The procedure is the same except that the Model #120 does not have a shield over the reeds. The metal top acts as a shield and the interior of the case is covered with an electrostatic shield paint.

ORDERING REPLACEMENT REEDS

The reeds on the Model #120 have been made stronger and should give very good service under any normal playing conditions. However, if it is necessary to order replacement reeds, please comply by the following instructions to insure receiving the proper reeds:

If reeds are desired for the 26th (A#) and the 46th (F#) notes on the electronic piano, order one reed No. 120-26-A# and one reed No. 120-46-F#.

Using the model number of the instrument as the prefix, then listing the key number and name of the note to designate the reeds will aid our Service Department in filling your order promptly and correctly.

IMPORTANT: All replacement reeds are tuned flat intentionally, for it is simple to file or scrape a little lead off the tips to bring them into proper tune after installing them on the bar. (See "Adjusting and checking Reeds" on Page 12 of the Model #112 section for tuning instructions.)

CARING FOR THE FINISH

See Page 12 in Model #112 Service Manual.

CLEANING KEYS

See Page 12 in Model #112 Service Manual.

AMPLIFIER

The amplifier is shown in Figs. 120-G, 120-R, and on the schematic wiring diagram, Fig. 120-Q, which also shows the value of component parts. Voltages are measured on a vacuum tube volt meter (VTVM) and are indicated on the print. The piano volume control and line switch are one unit and is located in the left keyblock. (Note: Fig. 120-P is a schematic drawing of control panel.) All tubes should be checked before working on the amplifier.

Any competent radio service man should be able to check the amplifier with the aid of the schematic drawing (Fig. 120-Q).

EARPHONES

The phone jack is located in the left keyblock as indicated in Fig. 120-G. The speaker is cut out when the earphones are plugged in. Any high or low impedance earphones will work satisfactorily. A second set of earphones may be plugged into the jack marked "speaker" if desired. See Fig. 120-H. The regular volume control in the left keyblock controls the volume for both of these jacks.

EXTERNAL SPEAKER

Any external low impedance speaker may be plugged into the jack marked "speaker" on the back of the case. See Fig. 120-H. Both the speaker in the unit and the external speaker will play when the external speaker is plugged into the "speaker" jack. If the external speaker is plugged into the phone jack, it cuts out the speaker in the piano. In either case the regular piano volume knob controls the volume of the speakers.

EXTERNAL AMPLIFICATION

The amplifier in the Model #120 Electronic Piano may be used as a pre-amplifier to drive a higher powered amplifier by plugging into either the phone jack in the left keyblock (which will cut out the regular piano speaker) or into the external speaker jack in the back of the case which permits the piano speaker to operate also.

Wurlitzer now has a specially constructed external amplifier, Model #920, which contains an 18 Watt amplifier driving a 12" concert speaker. It comes equipped with a 3 speed tremolo control, bass and treble controls as well as jacks for other instruments or microphones.

RECORD PLAYER JACK

Any high impedance phonograph pickup (record player) may be fed into the record input jack of the Model #120. See Fig. 120-H. The volume of the record player may be controlled by the regular volume control on the Electronic Piano.

SERVICE DEPARTMENT

See Page 16 of Model 112 section.

Fig. 120-P

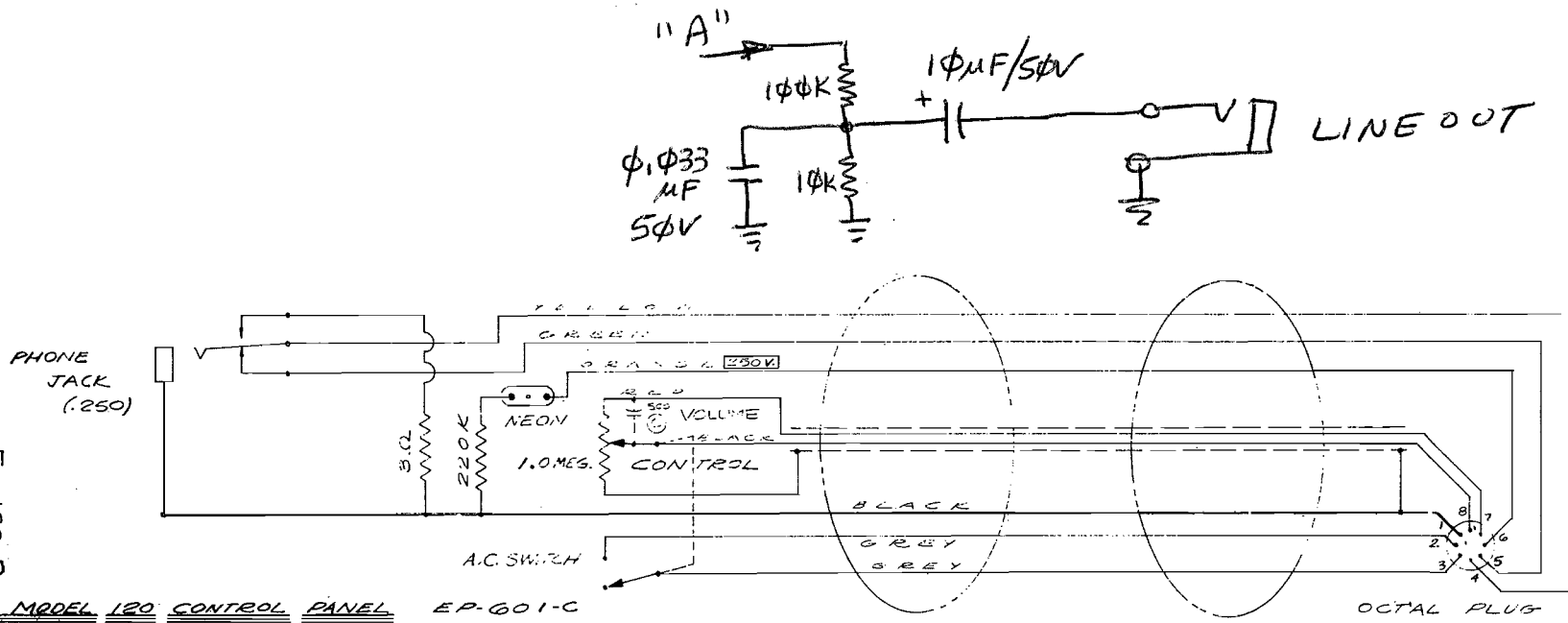

NOTE:
 NO. 2 GREY, NO. 3 GREY,
 & NO. 6 ORANGE WIRE,
 FROM OCTAL PLUG,
 MUST HAVE 1/32" MIN.
 WALL THICKNESS
 INSULATION.

Page 120-19

Fig. 120-Q

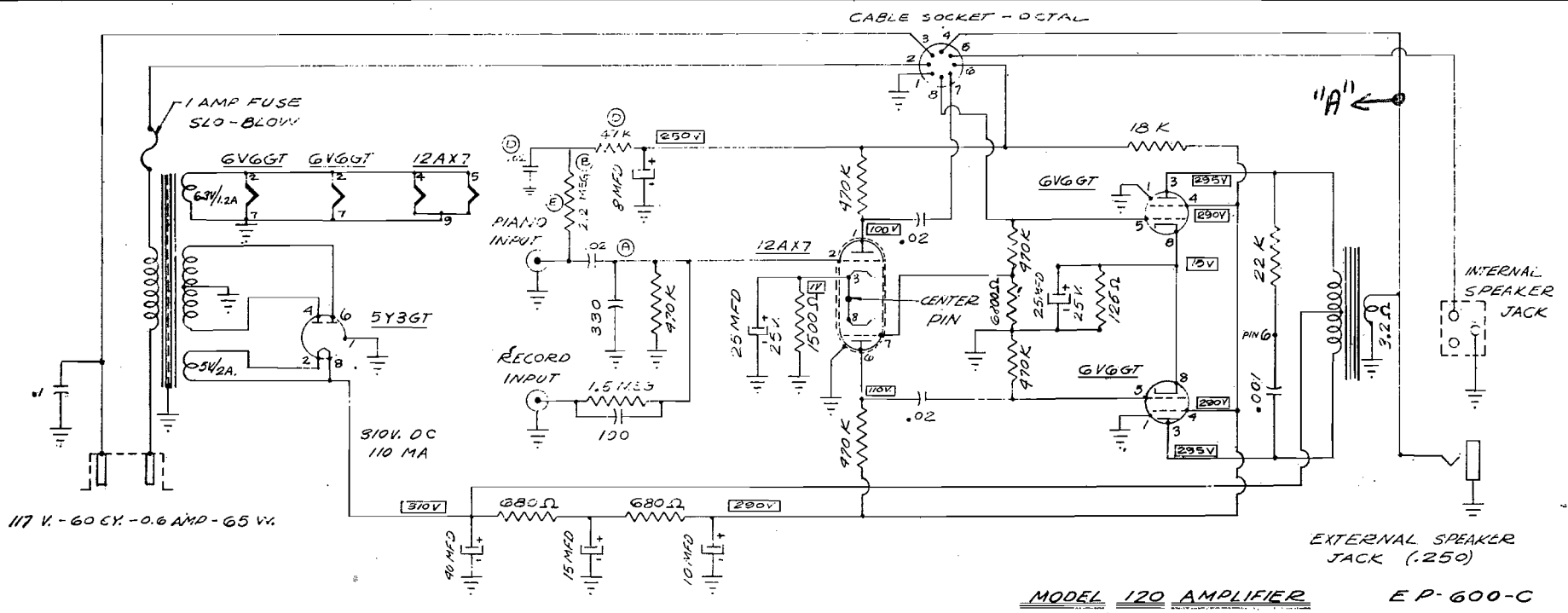

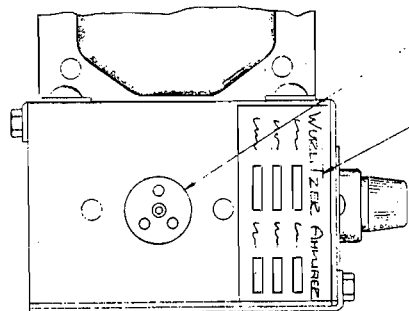
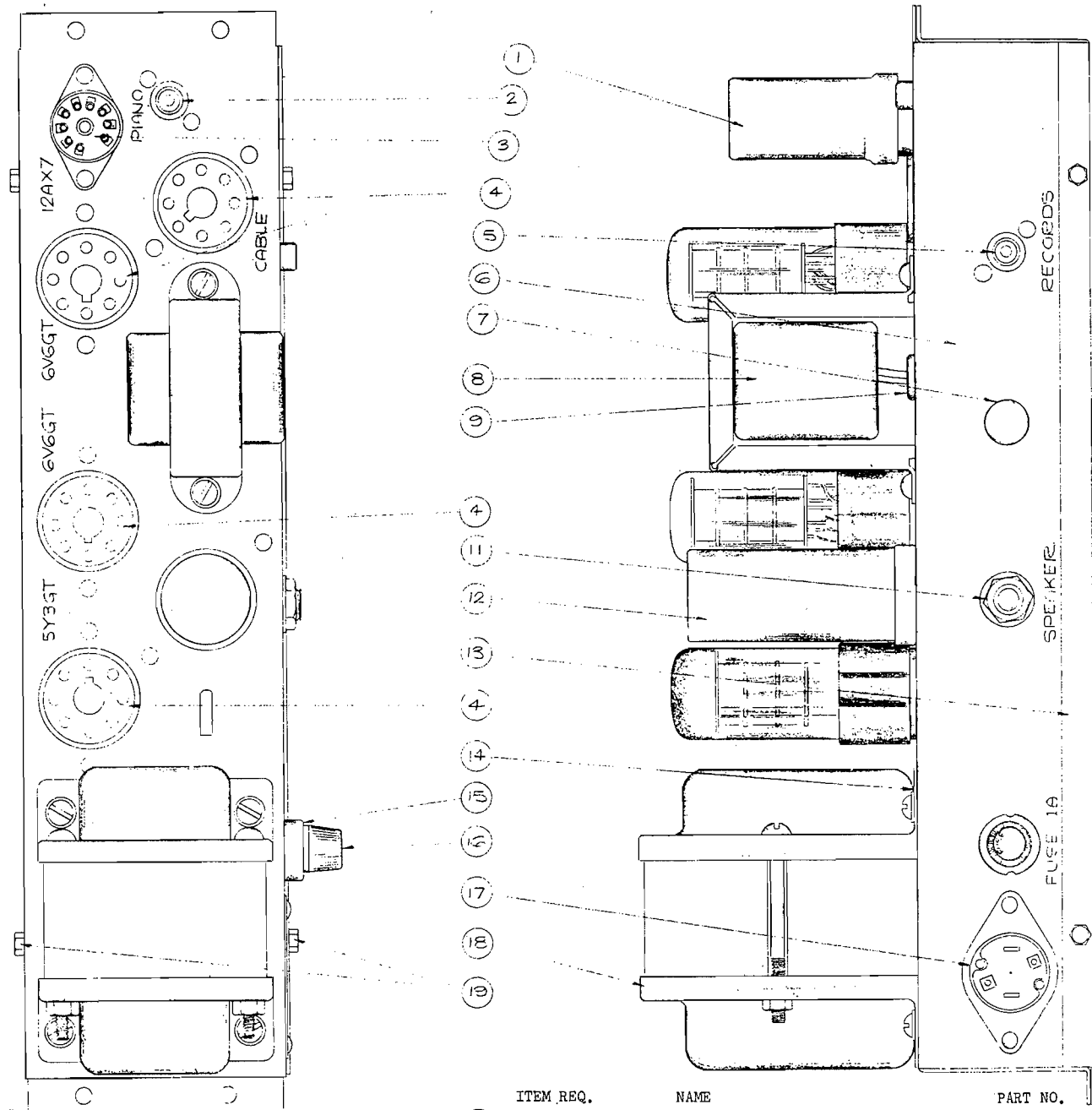

Fig. 120-R
120-20

ITEM	REQ.	NAME	PART NO.
1	1	TUBE COVER -----	EP-623a
2	1	PIANO JACK -----	EP-372a
3	1	NOVAL SOCKET -----	EP-614a
4	4	OCTAL SOCKET -----	EP-366a
5	1	RECORD JACK -----	EP-372a
6	1	CHASSIS TOP -----	EP-610c
7	1	HOLE PLUG -----	EP-633a
8	1	TRANSFORMER OUTPUT -----	EP-613c
9	1	GROMMET -----	EP-374a
10	1	SERIAL NO. PLATE -----	EP-615a
11	1	SPEAKER JACK -----	EP-369a
12	1	DRY ELECTROLYTIC 4 SECT. -----	EP-390a
13	1	CHASSIS BOTTOM -----	EP-611a
14	1	GROMMET -----	EP-377a
15	1	FUSE HOLDER -----	EP-378a
16	1	FUSE -----	EP-379a
17	1	A.C. LINE -----	EP-622a
18	1	TRANSFORMER POWER -----	EP-612c
19	4	1/4 #8 HEX HD. SHT. METAL SCR. -----	
20	1	SPEAKER SOCKET -----	EP-368a

INDEX

<u>A</u>	<u>Page No.</u>	<u>I</u>	<u>Page No.</u>
AC Cord.....	120-7	Introduction.....	120-1
Action; Regulation.....	120-11	<u>J</u>	
Action, Shrinking.....	120-11	Jacks.....	120-18
Amplifier.....	120-7,-17,-19	<u>K</u>	
Amplifier, External.....	120-18	Keys, Cleaning (Page 12 Model 112 Section)	
<u>B</u>		Keys, Damaged (Page 7 Piano Service Manual)	
Bar.....	120-10	Key Depth.....	120-11
(Also Page 7, Model 112 Section)		Keys, Easing (Page 4 Piano Service Manual)	
Bench Dimensions.....	120-2	Keys, Leveling (Page 11 Model 112 Section)	
<u>C</u>		Keys, Spacing (Page 7, Piano Service Manual)	
Cables.....	120-6,-7	<u>L</u>	
Capstan Adjustment.....	120-11	Let-Off Adjustment.....	120-13
Center Pin Replace- ment (Page 16, Piano Service Manual)		<u>P</u>	
Claims, Filing of (Page 26, Piano Service Manual)		Preparation of Model 120 For Sale.....	120-3
Conclusion (Page 16, Model 112 Section)		Pick-Up (Page 7, Model 112 Section)	
Cross Section of Model 120 Electronic Piano..	120-9	Pilot Light.....	120-7
<u>D</u>		<u>R</u>	
Damper Adjustment.....	120-15	Range (Page 7, Model 112 Section)	
Diagram of Wurlitzer Electronic Piano.....	120-9	Record Player.....	120-18
Dimensions.....	120-2	Reeds.....	120-17
<u>E</u>		<u>S</u>	
Earphones.....	120-18	Schematic Diagram of Amplifier and Con- trol Panel.....	120-19
External Amplification.....	120-18	Service Department (See Page 16, Model 112 Section)	
External Speaker.....	120-18	Specifications.....	120-2
<u>F</u>		Spoon Adjustment.....	120-14
Fall Cover, Removing of ..	120-4	Striking Point.....	120-15
Finish, Care of (Page 12, Model 112 Section)		Switch.....	120-7
Fuse.....	120-7	<u>T</u>	
<u>H</u>		Tone Principle (Page 7, Model 112 Section)	
Hammers, Burning.....	120-16	Touch (Regulating Pro- cedure).....	120-11,-12,-13
Hammers, Blocking.....	120-16	Tubes.....	120-6,-20
Hammers, Let-Off (See Regulating Proce- dure, Pages 120-11, -12,-13)			

INDEX (cont.)

<u>V</u>	<u>Page No.</u>
Voltages.....	120-2,-7,-19
Volume Control...	120-2,-7,-19