

SEPTEMBER-OCTOBER 1976 \$1.25

Synapse

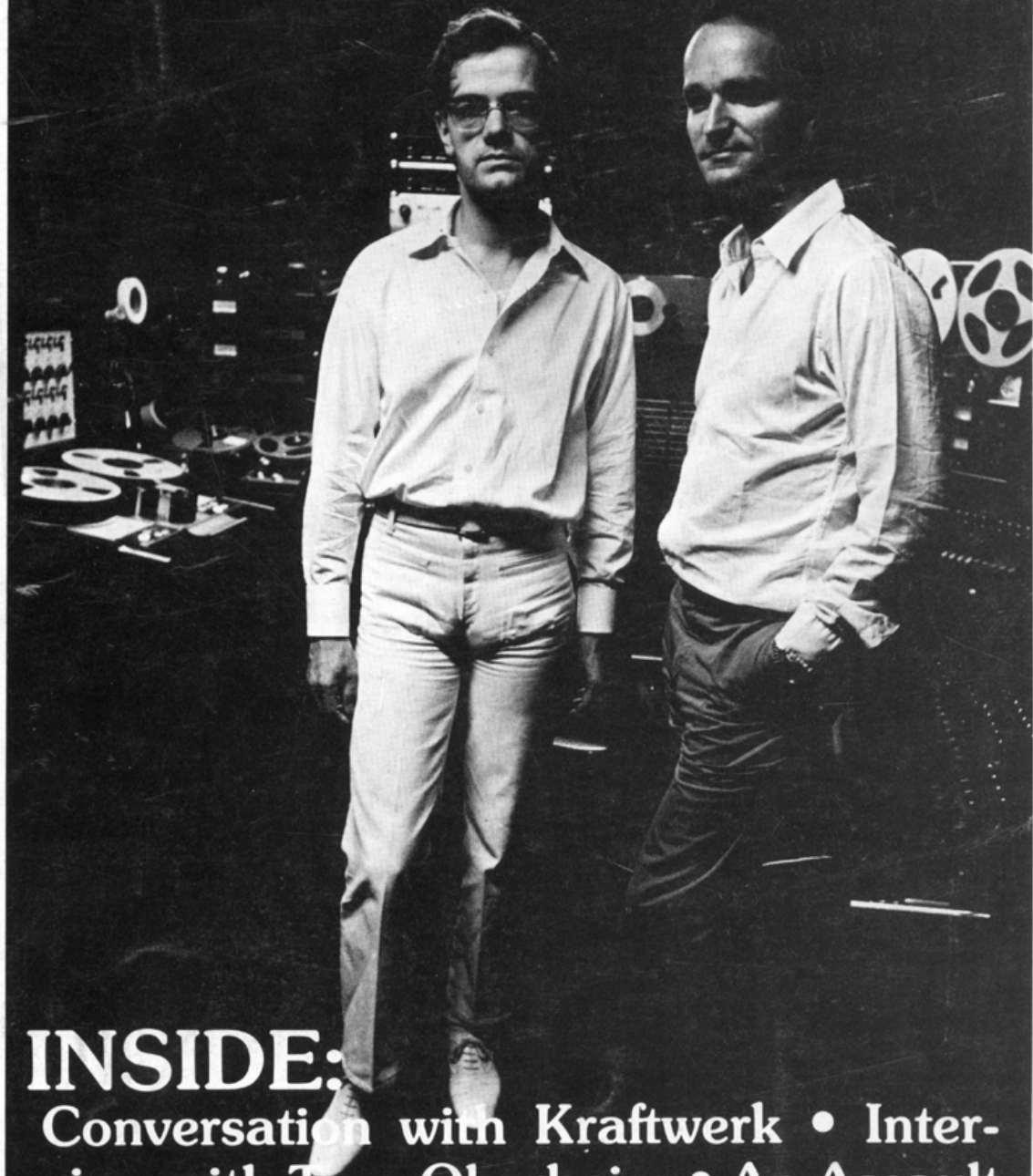

INSIDE:

Conversation with Kraftwerk • Interview with Tom Oberheim • An Assault On New York City • Plus much more.

VOLUME 1

ISSUE 3

THE ULTIMATE KEYBOARD MACHINE

Pictured here is the most incredible development yet for the multi-keyboard artist. At first glance it's an Oberheim Four-Voice Polyphonic Synthesizer — already accepted as the best money can buy.

What's new is the Polyphonic Synthesizer Programmer. It's a memory device that stores patches of your own creative design and allows you to recall any of them at the push of a button. And you're still not locked in because they're all completely variable at your discretion.

Complaints about the inability to patch quickly while on stage or in the studio, the creative barriers of pre-set instruments, and the burden of carrying six or more keyboards are now over.

The problem for most keyboard players isn't getting enough instruments to create on. It's getting one totally versatile instrument to create with.



Oberheim

Some Things Are Better Than Others

Oberheim Electronics, Inc., Dept. B
1549 9th St., Santa Monica, CA 90401

Synapse

SYNAPSE

VOLUME 1

ISSUE 3

SEPTEMBER-OCTOBER 1976

Editors
Angela Schill, Douglas Lynner

Art Director
Chris August

Copy Editor
Diane Levine

Photographer
Bill Matthias

Correspondents
Connecticut: Chuck Scribner
Maryland: Paul Medlock
New York: Randy Cohen

Contributors
Craig Anderton, Arpad Benares,
John Blacet, Gee Chang, Alex
Cima, Randy Cohen, Phil Elwood,
Larry Fast, Peter Hillen, Stan Le-
vine, Bryce Robbley, Danny Sofer,
Phil Terr, Cynthia Brett Webster

Publisher
Angela Schill

Making Music With Calculators	5
<i>It All Adds Up to Music - Craig Anderton</i>	
The Audium	6
<i>Sound in Space - Phillip Elwood</i>	
Taking It to the Streets	8
<i>The Electronic Music Mobile Assaults New York - Randy Cohen</i>	
Kraftwerk Interview	10
<i>With Doug Lynner and Bryce Robbley</i>	
Interview with Tom Oberheim	14
<i>With Cynthia Brett Webster</i>	
The Starmaking Machinery	16
<i>Larry Fast Talks About Synergy</i>	
Constructing an Arabesque Generator	18
<i>The Analog Shift Register - Arpad Benares</i>	
Light with Sound	20
<i>Voltage Control Visuals - Alex Cima</i>	
Build It	21
<i>A Seven-Stage Frequency Divider - John Blacet</i>	
Performance Review	22
Record Reviews	23
What's Happening	2
Computers	3
<i>How Computers Talk to Synthesizers - Peter Hillen</i>	
Sample & Hold	4
<i>Time vs. The Critics or The Wolf at The Door - Stan Levine</i>	
Listings	4
<i>Manufacturers, Consultants, Schools</i>	
Book Reviews	32

SYNAPSE MAGAZINE is published bi-monthly by Schill and Schill Publishing, 1151 Macneil Street, San Fernando, California 91340. (213) 361-6625. No part of this magazine may be reproduced, either mechanically or by other means, without the written permission of the publisher. Copyright 1976 by Schill and Schill Publishing. Printed in the United States of America.

SUBSCRIPTIONS: U.S. and Canada \$6.00 for six issues, foreign subscriptions \$7.50 for six issues. Single copy newsstand price is \$1.25.

MANUSCRIPTS: We cannot be responsible for the return of any unsolicited manuscripts, photographs, artwork, or scores. All contributions are welcome and should be addressed to: SYNAPSE MAGAZINE, P.O. Box 359, North Hollywood, California 91603.

CHANGE OF ADDRESS: Notify SYNAPSE MAGAZINE/SUBSCRIPTION DEPARTMENT, P.O. Box 359, North Hollywood, California 91603. Please send both the old and new addresses, and if possible, the mailing label from a copy of SYNAPSE.

sample & hold

with Stan Levine

...Time Vs. The Critics Or The Wolf At The Door

Dionys Weber didn't like it at all and took every possible opportunity to say so. Anton Schindler said that it was regarded by some critics as "a dangerously immoral composition, much too long, and without unity." (1.) The critic of the *Allgemeine Musckalische Zeitung* described it as, "a daring wild fantasia of inordinate length ... the work seems to lose itself in utter confusion." (1.)

These critics were contemporaries of the composer. They were hearing the music conducted by its creator. There was no controversy over interpretation and the composer's intent. These men had everything on their side and working in their favor, except time.

What might people say of this work, fifty, one hundred, or one hundred and fifty years later? Will it survive the sifting and weathering of time? How will the criticism of time measure not only this musical composition, but the criticisms of the composer's contemporaries?

Well, in this case, the criticism of time was in favor of the composer and against the critics. The composer who had the audacity to create this work was Ludwig Van Beethoven. This "confusing" composition, which some people believe today to be among the most perfectly formed, is "Eroica," Symphony #3 in Eb Major, Opus 55.

Today we are looking at electronic music with much the same handicap that Beethoven's contemporaries had. We lack the perspective of time. Each piece of music is new and jarring. It's not comfortable and familiar. It hasn't had the chance to be heard over and over again to be really well evaluated. The musical vocabulary is new and not completely established yet. Many new works are simply experiments, inspired by new techniques discovered or new instruments that are available. Even the composer is not in a position to evaluate its enduring value.

To confuse things further, we are hearing everything; the best along with the worst. After a few years or decades, the less important works will become apparent and fade into obscurity. The greater works will endure through intense scrutiny and evaluation.

I really try to keep all this in mind when listening to a new piece of music. I try to listen without preconceived notions or expectations. I try not to judge on the first

editor's note

Synapse has undergone great reorganization and growth since the last issue in order to guarantee a more important future. Our purpose in editing Synapse, is to furnish a source of information, as well as providing a forum supportive of the ideas and development of electronic music and related fields.

We strongly encourage our readers to assist us in meeting these goals by way of literary contributions and our "Letters to the Editors."

We see reader participation to be an invaluable aid, as we continually re-examine the ways in which we can best serve this new and vital form of communication.

- Douglas Lynner
Angela Schill,
Editors

hearing, but truthfully, it's impossible. I only hope that none of my gross misjudgments will end up in print so that someone can joke about my opinions in 171 years.

This is the first entry into what I hope will be a regular column in *Synapse*. This column will vary from issue to issue, at times focusing on one specific topic, and at other times covering briefly several divergent topics. At this time there are a couple of areas which interest me especially: the question of developing a universal electronic music notation, the problem of copyrighting electronic music, all the different areas of multi-media and how electronic music relates to them, and the development of new electronic instruments ... what they might be and how they might benefit the music. In choosing future topics, I would also like to ask for your ideas, information, suggestions, criticisms, and general help. Please write to me in care of *Synapse*.

Finally, let me introduce myself. I am Stan Levine; I am a composer and teacher. I write music mainly for films, and teach on the college level and privately. My electronic music studio is equipped with Moog, Buchla, Serge, and 360 systems and related recording equipment.

I have not yet decided on the topic for my next column, a lot depends on you, the reader. I think, though, it might be a collaboration with Serge Tcherepnin about electronic music systems.

Until next time, *sample everything and hold* what you like.

(1.) The Nine Symphonies of Beethoven in Score, Albert E. Weir, Editor. From page 55. Bonanza Books.

computers with Peter Hillen

... How Computers Talk To Synthesizers

Anyone who has ever travelled in a foreign country knows the problems of communication when they do not speak the language. The same problems arise when a computer and a synthesizer electrically try to talk to each other. Fortunately, just as there are interpreters for human languages, there are interpreters for the languages of computers and synthesizers. These interpreters are called, appropriately enough, Analog to Digital (A/D) and Digital to Analog (D/A) converters.

A synthesizer is an analog device. This means that the inputs and outputs are capable of covering a continuous span of voltages with no steps or discontinuities. The hands of a wristwatch are analog in that, as they move around the dial, they point to each possible instant of time.

A computer on the other hand is digital. Everything happens in discrete quantities. There are no continuously variable voltages on the output; everything is represented by a definite number. The new LED watches are a good example of the meaning of digital. To this type of watch, time goes in one-second steps with no finer partitions.

The job of an A/D converter is to take the analog voltage from a synthesizer and convert it to the nearest discrete number the computer will recognize. The job of a D/A converter is to take a number from the computer and convert it to an analog voltage for the synthesizer. Two of the most important parameters in doing a conversion are the Resolution and Sample Rate.

Resolution determines how fine the steps are between consecutive numbers generated by the computer. If the only thing a computer is to do is generate the values of any of the 88 notes of a piano, then only 88 steps are required and they are a half tone apart. If, however, it is necessary to generate control voltages equivalent to running down the string of a guitar, then more steps are needed. The number required is dependent of the ability of the ear to detect the step size, which must be less than a few cents. Typically, the step size is 1/1024 to 1/4096 of the range.

Sample Rate is how fast the computer takes in or puts out numbers. If the sample rate is too slow, the signal being monitored will change too much between samples and the computer will not record an accurate representation of the slowly, the result is a random signal. As the speed is increased, the output will eventually start sounding more like the input. It is necessary to sample at least twice the frequency of signal being sampled to get accurate reproduction.

Now that the synthesizer and computer have been linked up, we can start in the next issue to explore what they can do together.

what's happening

... **Star Inc.**, P.O. Box 71, Stafford Springs, Conn. 06076 will have a new line of synthesizers out on the market this fall ... **Serge Modular Systems** is offering an electronic saxophone and there are rumors about a mysterious electronic reverb ... **John Blacet** has developed a 7-stage frequency divider modification kit ... **ARP** has a new guitar synthesizer and we are all waiting with baited breath for the **Polymoog** ... In a recent interview with *Playboy*, **David Bowie** said that his favorite group was **Kraftwerk** ... **Kraftwerk's** new album, *Europe Endless*, Capitol Records, will be released in the fall and they will be touring the U.S.A. in early 1977 ... **Lem** is finishing the master for their first LP, more soon ... the **Real*Electric Symphony** will be touring the U.S.A. this fall ... **Star Track Recording Studio** recently opened in L.A. and is especially equipped for electronic music ... **Oberheim** has added a patch programming ability to their polyphonic systems ... Here's a computer magazine you may not know about: **The People's Computer Company**, P.O. Box 310, Menlo Park, Calif. 94025 ... **Patchwork Sound** in L.A. has opened with a complete line of synthesizer services ... want a **Synergy T** shirt? Write to: I.R.S., P.O. Box 343, South Plainfield, N.J. 07080, \$4.50 postage included.

NOTE: Please refer to our **Listings** column for any addresses you did not find above.

eye,
ear,
nose &
throat

DESIGN & PHOTOGRAPHY
(213) 986-3951

Playing Music With Calculators: It All Adds Up To Music

by Craig Anderton

One of the nicest aspects of playing with electrical music is that the possibilities for toys are endless. For example, have you checked out calculator music? For this all you need is a calculator, but two calculators are better and scientific calculators are best. You also need a transducer to take the signal out of the calculator and put it into audible form.

Guitar pickups make good trans-

ducers, although the signal is rather feeble and you'll have to add some kind of preamplification. A fuzztone will work in a pinch, since the signal is low enough that the fuzz will probably not be driven into clipping.

A more interesting transducer is an AM radio, tuned to a spot in between stations (or at least somewhere fairly clear). As you move the calculator towards the antenna, you'll hear some strange sounds; the closer you get to the radio, the louder the sounds. The guts of the calculator will frequently give a different signal from the read-outs in the more complex models. Entering different numbers and functions will cause an interesting variety of signals. Not only do you get the original clock pulses and residuals inside the calculator, but the interaction with the AM radio produces all sorts of harmonics and heterodynes, sort of like a polytonic, out of control Theremin.

My Novus "Mathematician" makes the best sounds on overflow or error indications, and the various trigonometric functions. Raising to a power also produces a fascinating sound not unlike the sound track of your average 1950s science fiction movie.

I tried out the same exercise with a "four-banger." While not as dramatic as the "Mathematician," it nonetheless obliged with various boops and beeps. In fact, the two make pretty good harmony together. Due to the variation among the internal oscillators, even the same models of calculators will frequently produce different sounds.

Try some calculator music, it's really fun and will astound anybody foolish enough to wander in while you're waving a couple of calculators around an AM radio. Naturally, like any musician, I hope to move up to a better instrument. I wonder what a programmable one sounds like?

PATCHWORK SOUND



Synthesizer Specialist

- discounts on sales and studio session rentals
- instruction
- modifications
- consultation
- production

14759 Hesby Street
Sherman Oaks, California
(213) 990-2984 91403

listings

MANUFACTURERS

ALAN LABS
Box 434, Van Nuys, Calif. 91408

ARIES INC.
119 Foster St., Peabody, Mass.
01960

ARP INSTRUMENTS
320 Needham St., Newton,
Mass. 02164

JOHN BLACET *
4019 Chico Ave., Santa Rosa,
Calif. 95401

BUCHLA
Box 5051, Berkeley, Calif. 94705

CFR ASSOCIATES *
Box F Newton, New Hamp.
03858

CONCERT COMPANY **
3318 Platt Ave., Lynwood, Calif.
90262

DAVEL
Box 279, Verdugo City, Calif.
91246

EMU SYSTEMS
3455 Homestead Rd., No. 59,
Santa Clara, Calif. 95051

ELECTRONIC MUSIC STUDIOS
(LONDON) LTD.
277 Putney Bridge Road, London,
England SW15 2PT

ELECTRONIC MUSIC
LABORATORIES
460 West St., Amherst, Mass.
01002

FARFISA
West L.A. Music
11345 Santa Monica Blvd., Los
Angeles, Calif. 90025

HAMMOND
4200 Diversey, Chicago, Ill.
60639

HARVEST PRODUCTIONS
Gregory Kramer
135 W. Broadway, New York, N.Y.
10013

IONIC INDUSTRIES
128 James St., Morristown, N.J.
07960

KORG/UNIVOX/MERSON
75 Frost St., Westbury, N.Y. 11590

LYRICON/SELMER
Box 310, Elkhart, Ind. 46514

MOOG/NORLIN
7373 N. Cicero Ave., Lincoln-
wood, Ill. 90646
Customer Service: Box 131,
Academy St., Williamsville, N.Y.
14221

NOTE:

- * manufacturer makes kits only
- ** manufacturer makes both kits and finished product

listings

NOTE:

- * manufacturer makes kits only
- ** manufacturer makes both kits and finished product

OBERHEIM ELECTRONICS
1549 Ninth St., Santa Monica,
Calif. 90401

OCTRON
1346 Bayport Ave., San Carlos,
Calif. 94070

OZNIE/PROCESS ELECTRONICS
Box 7, Centerville, Penn. 16404

PAIA*
Box 14359, Oklahoma City, Okla
73114

POLYFUSION
6 Cindy Dr., Williamsville, N.Y.
14221

ROLAND/BECKMAN
2117 Yates Ave., Los Angeles,
Calif. 90040

SEQUENTIAL CIRCUITS CO
7150 Rainbow Dr., No. 7, San
Jose, Calif. 95129

SERGE MODULAR MUSIC
1107½ N. Western Ave., Holly-
wood, Calif. 90029

STAR INCORPORATED
Box 71, Stafford Springs, Conn.
06076

STEINER-PARKER
2258 South, 2700 West, Salk
Lake City, Utah 84119

SYN-CORDION
32-73 Steinway St., Long Island
City, N.Y. 11103

SYN-KEY
spg 117 W. Hintz Road, Wheeling,
Ill. 60090

SYNTORCHESTRA
see FARFISA

TOTAL TECHNOLOGY
see OCTRON

VAKO SYNTHESIZERS INC.
4651 62nd Ave., N., Saint Peters-
burg, Fl. 33565

YAMAHA
Nippon Gakki Co., Ltd.,
Hamamatsu, Japan
360 SYSTEMS
2825 Hyans St., Los Angeles,
Calif. 90026

CONSULTANTS:

LECTRON MUSIC LAB
Box 1594, Hollywood, Calif.
90028

PATCHWORK SOUND
Jack Howe
14759 Hesby St., Sherman Oaks,
Calif. 91403

STAR TRACK RECORDING STUDIO
8615 Santa Monica Blvd., Los
Angeles, Calif. 90069
(213) 855-1171

SYNAPSE
Box 359, North Hollywood, Calif.
91603

SCHOOLS:

BOSTON SCHOOL OF
ELECTRONIC MUSIC
326 Dartmouth Ave., Boston,
Mass. 02116
(617) 261-1634

CONTEMPO MUSIC GUILD
13273 Ventura Blvd., Studio City,
Calif. 91604
(213) 784-8271

DICK GROVE MUSIC
WORKSHOPS
12754 Ventura Blvd., Suite 2,
Studio City, Calif. 91604

SOUND ARTS
2825 Hyans St., Los Angeles,
Calif. 90026
(213) 487-5148

SHERWOOD OAKS EXPERIMENTAL
COLLEGE
6353 Hollywood Blvd., Holly-
wood, Calif. 90028
(213) 462-0669

lem



For Information and Booking
call or write

Moldar Productions
1670 N. Crescent Heights Blvd.
Los Angeles, Cal. 90069
(213) 654-3755

**SYNAPSE
HAS A
NEW
ADDRESS:
P.O. Box 359
N. Hollywood,
Ca. 91603**

THOMAS HAMILTON:

"PIECES FOR KOHN"

A Recording of Electronic Music

Order from your record store, or send \$6.98 to:

 Somnath Records
6159 Columbia Avenue
St. Louis, Missouri 63139

Audium: Sound In Space

by Phillip Elwood

Stan Shaff and Doug McEachern are sculptors in sound and space. Their creation is called "Audium," an hour-and-a-quarter concert of sounds which the audience experiences sitting in total darkness as 136 speakers in the small, planetarium-like Audium theater project the taped compositions of Shaff.

Audium has been around in various forms since 1960; it was part of the UC Extension Center's Renaissance of the Arts series and then was presented, still as a portable "show," at the Museum of Art auditorium. Many listeners remember Audium's Fourth Street location where Shaff and McEachern developed the fascinating and complex "Theater of Sound-Sculptured Space" which they now present in their elegant, technically superb, headquarters at 1616 Bush Street, just off Franklin.

Not surprisingly, Shaff and McEachern are both musicians. Playing and listening in the 1950s as electronics came to play an increasingly important role in musical creativity they found a common interest in probing the possibilities of compositions in recorded sound, and space.

Shaff composes (i.e., he organizes the taped sounds, effects, space, etc.) and McEachern handles the technical aspect.

Entering the Audium theater — domed, white, with speakers, baffles, walls and ceiling neatly distributed — the audience (about 50 maximum) sits in fixed chairs, loosely placed in concentric circles.



Doug McEachern, engineer, and Stan Shaff, composer, and their "Theater of Sound Sculptured Space" in San Francisco.

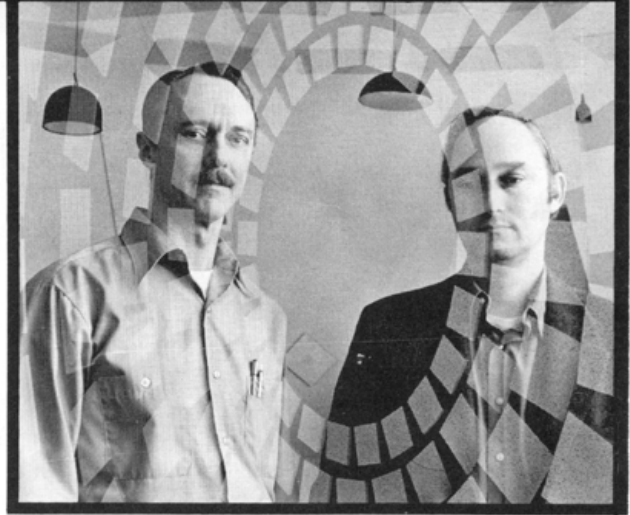

The lights dim, the sounds start. Water bubbles, voices come and go, outer-space audio exotica mixes with familiar musical instruments; the sound of silence is as respected as the bombast of pure noise. Dynamics are carefully supervised and effects come from everywhere, sometimes circling the room, sometimes splatting down hard and fast, sometimes roaring through like a passing U.F.O.

Many in the audience find the concert exciting, others become exhausted; some are tense throughout, some drift with the performance, caught up as in a dream ... or nightmare.

Much of the effectiveness of the presentation comes from the acoustically perfect mini-dome which is the Audium theater. Built in part with National Endowment for the Arts funds, the room itself seems to float in air, and it is, indeed, an enclosure built within a room ... silence, sound, darkness and light are absolute and penetrating.

McEachern "conducts" performances from a console which juts from the wall, guiding the sounds like a remote control navigator.

Reprinted with permission of the S.F. Examiner

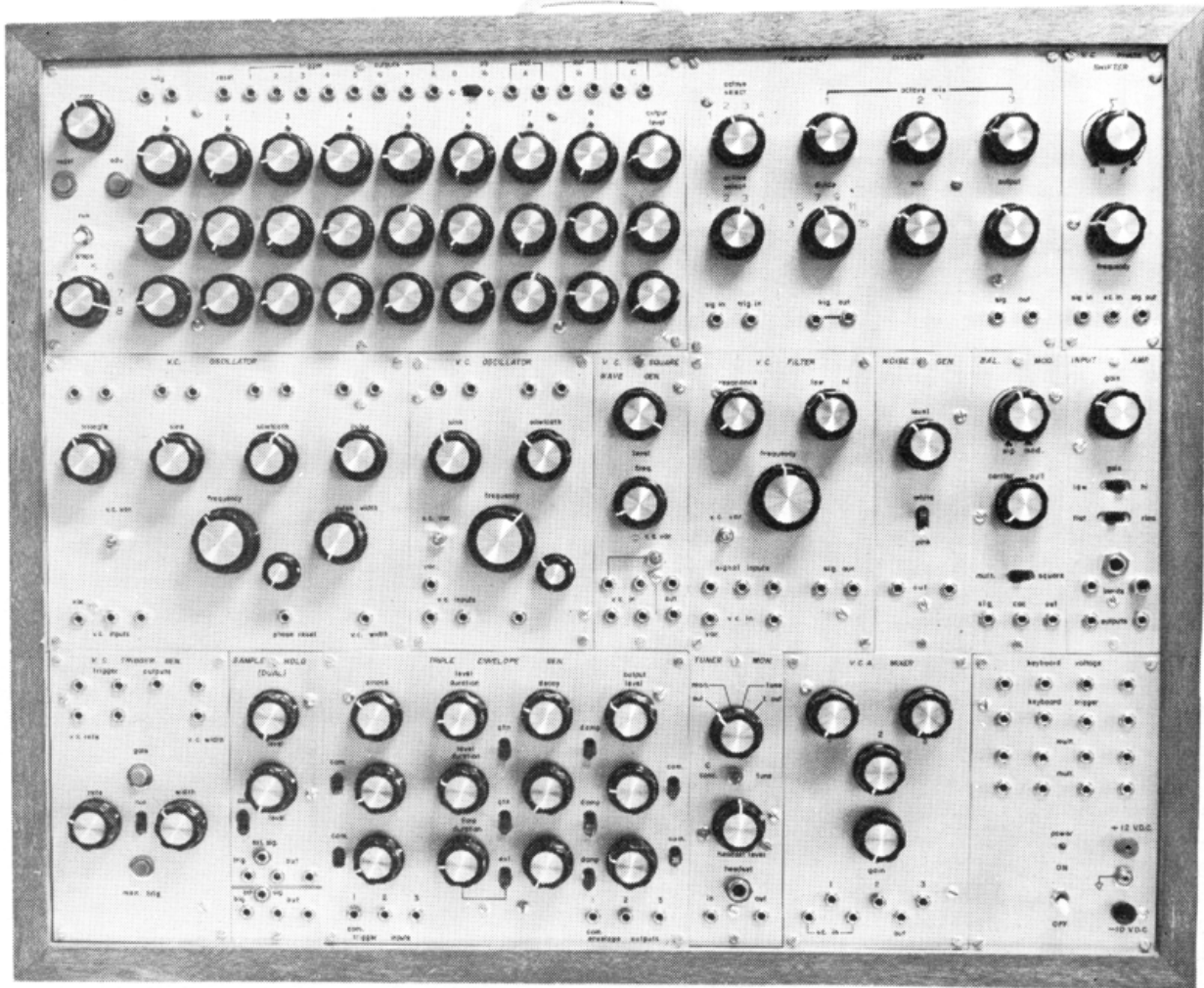

the Synthasystem

**we
have:**

- the Synthasystem
- the Synthacon
- the Multiphonic
Keyboard
- the Electronic Valve
Instrument

STEINER-PARKER 2258 South 2700 West, Salt Lake City Utah 84119 (801) 972-1447

Taking It To The Streets: The Electronic Music Mobile Assaults New York

by Randy Cohen

CBS: "How do people seem to respond to the music?"

KRAMER: "Sometimes they like it which is just as good as when they don't."

CBS: "You don't care?"

KRAMER: "I can't care. The music is going in certain directions and I have to follow those directions."

CBS: "Kramer says that he doesn't care if people like his music, and frankly, Kramer, I don't."

It was the standard Saturday afternoon in the park, with a typically casual group of people gathered around your basic statue of general-on-horseback, watching an atypical activity. The park was New York City's Central Park; the general was William Tecumseh Sherman; the horse, unidentified. A group of musicians were unloading equipment from a yellow econoline van and running cable to a generator in a telephone company truck. General Sherman and his horse were gradually being walled in by a circle of synthesizers for the season's first performance of the Electronic Music Mobile. The crowd was curious, moving in close.

So was the start of the Electronic Music Mobile: five performances by Gregory Kramer in various New York City parks last summer. Kramer has long been interested in outdoor performances. He has given several in California: on the beach at Venice and as part of the 1973 Source Magazine



New Music Festival in the San Bernardino mountains. He has played in the woods of New Hampshire and in the streets of Cambridge. This series marked his first foray into the parks of New York City. Each concert was performed by three synthesists, sometimes accompanied by other instrumentalists. Kramer arranged for necessary permits from the Parks Department. He mustered support from the Department of Cultural Affairs and convinced the telephone company to supply a generator and transportation. He organized publicity, enlisted players, and composed most of the pieces. By the end of the series, the

performances had attracted reviews from several New York papers, as well as filmed coverage on the local CBS news.

His background was appropriate to this project. Kramer was a student of composition at the California Institute of the Arts in Valencia. In addition to his composing and performing work, he manages Electron Farm, a company selling a modified version of the CBS-Buchla 100 series synthesizer. Electron Farm provided several of the systems in this series, as well as offering technical and financial assistance. Kramer is on the faculty of New York University, where he teaches ad-

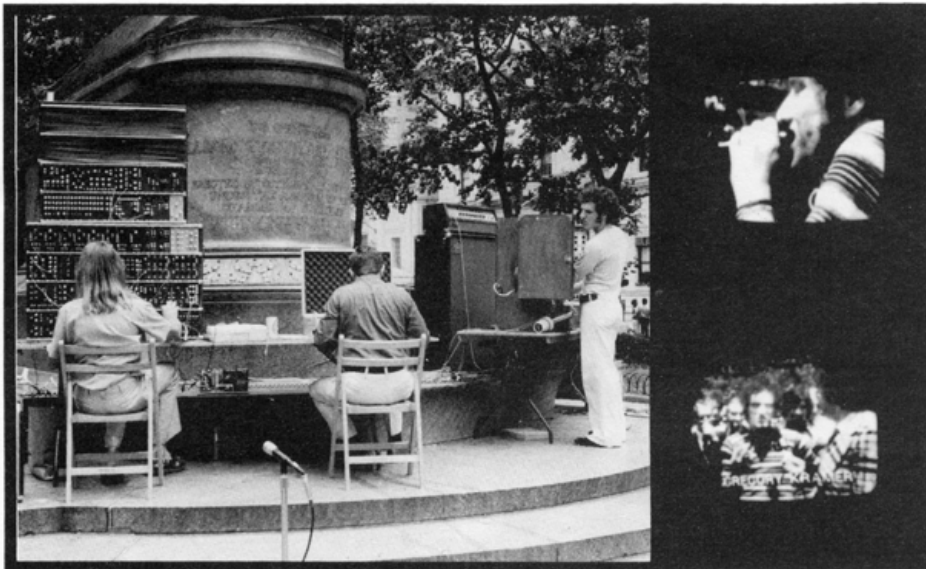

**Low art seeks to attract, high art seeks to repel:
Gregory Kramer (standing, above) and the Elec-
tronic Music Mobile at Washington Square.**

vanced synthesizer technique. He is currently involved in a venture to establish public access to an electronic music studio in New York. He spoke about the motives behind Electronic Music Mobiles:

"Mostly, I just wanted to play with other electronic music people. There was little activity in New York at that time, and I wanted to see more. I like hearing music outside the concert hall. That setting is not really appropriate to electronic music, and besides, you draw that audience anyhow. This way, you also get a random sample of the populace, and they can come and go as they please."

Although that afternoon in Central Park was successful as a social event, the music itself (a group of improvisational pieces), never really worked well. Kramer, along with players Rhys Chatham and Jim Burton, agreed that the pieces had not been given adequate rehearsal time. Chatham said, "I felt pleased about doing this in the park and I was especially happy that the audience was in no sense captive. But I felt that the music was not very successful." The third concert in the series was held in Battery Park, at the tip of lower Manhattan. Kramer was joined by Suzanne Ciani, using Buchla 200 series modules, and Ralph Jones, using Moog equipment.

The fourth concert took place outside of Co-op City. It was performed

by Kramer along with Jan Hall and Ralph Jones. The heat grew unbearable with the temperature reaching 100 degrees. The telephone company van containing the generator failed to arrive, forcing the players to power their synthesizers from an AC tap in a lamp post. This line struggled to produce 80 volts, far from the 120 required by these machines. If the players were made uncomfortable by the excessive heat, the synthesizers were made mad by the inadequate electrical supply. The machines seemed to be teetering on the edge of nervous collapse, triggering themselves at random. Whenever one player raised the volume of his sounds, the frequencies would drop on the sounds of the other two players. The afternoon culminated in the theft of Kramer's watch.

There was only one concert remaining in the series. It was at this event, held in Washington Square Park, that the Electronic Music Mobile was to vindicate itself. Musically and socially, it was the best performance of the series.

There are several vaguely musical methods of crowd control. Getting a crowd to rush the stage seems to be the main pre-occupation of pop groups. At the Electronic Music Mobile's Washington Square concert, the crowds were made to back up. This may be the primary difference

between low art and high art. Low art seeks to attract; high art seeks to repel.

Keshavan Maslak, a woodwind player, was given a long flute solo in Kramer's piece "Kes." The volume of that solo moved the crowd backwards. Seldom has there been such an enthusiastic retreat from musical expression. He drove them backwards with sheer esthetics, back to the edge of that park's famous fountain, back until they could retreat no further if they were to hold any park ground at all.

Another player, Boris Police Band, clad in black leather, performed on a Fender violin covered with black polyurethane paint. The violin was plugged into a fuzz-tone which was plugged into an anonymous black box, which was plugged into another, etc. He played "Unrequited Violence" and it was magnificent, the strongest statement of the entire series. It was a tremendously powerful mix of violin and vocal sounds. Police Band displayed incredible control over complex, dense textures. He played with clarity, wit, and precision. It was striking and exciting, both musically and visually. The crowd tumbled over each other in their efforts to escape it.

The entire Washington Square event was the strongest presentation of the series. The logistical and musical problems had been worked out in the previous concerts, and the players had grown familiar with one another's styles. The pieces were well rehearsed and well received. In addition to those mentioned above, the players were Jan Hall, using a large system he designed and built himself and Marc Battier, a composer from the University of Paris, using Electron Farm gear. The concert included compositions by Kramer, Battier, and Police Band as well as several sections from Stockhausen's "The Seven Days."

Gregory Kramer applied the experience of that series to his plans for future summer concerts. Rather than using a different group of performers for each concert, he will work with the same people for most of the events. He allowed more rehearsal time than he did last year. This year's series began in the first half of July and several of the concerts were presented as a part of New York City's Bicentennial celebration. In addition to the concerts within the city, Kramer plans to mount performances all around New York State, provided he can acquire the necessary funding.

**A
CONVERSATION
WITH
RALPH HUTTER AND
FLORIAN SCHNEIDER
OF
KRAFTWERK,
with
Doug Lynner and Bryce Robbley
of Synapse**

This conversation reflects many of Kraftwerk's current musical and philosophical concerns. Kraftwerk is: Ralph Hutter, Florian Schneider, Wolfgang Flur, and Karl Bartos. They have toured Europe and the United States with great response. This conversation took place on August 28th, 1976, in the fitting atmosphere of Star Track Recording Studio in Los Angeles.

Special thanks to Karin Glaser for her help.

Doug: *"How did Kraftwerk begin? And what were you doing at that time?"*

Ralph: "We had been getting together at the musical academy and then started to perform live concerts of amplified music in '68 and then directly getting into what we call repeat music and from then on we started to continually work. In 1970 we opened our studios, Kling Klang Studios, Dusseldorf, just with some tape recorders and that was the beginning of our recording activities. From then on we worked in our studio, progressing from one thing to the next."

Doug: *"You and Florian started Kraftwerk?"*

Ralph: "Yes."

Doug: *"When did you add the other members?"*

Ralph: "We have always worked with different people according to the music we have been writing. Sometimes we have 6, 4, 5, 3 members. We even played a series of concerts with just the two of us. There was an album of that period. We have two electronic drummers in our new group, which has been the most consistent so far."

Doug: *"Could you explain what kind of instruments the electronic drummers play?"*

Ralph: "Self-designed electronic drums that are manually operated. We

also have, of course, automatic electronic sequencer drums. It is not a great invention in a sense but the way it effects our psychological performance has been very strong. There is no member in our group producing direct acoustic sounds, we create loud speaker music, direct loud speaker impact."

Doug: *"When you were at the academy, were you studying music and composition?"*

Ralph: "Yes."

Doug: *"Who were you studying with?"*

Ralph: "Nobody of any stature."

Doug: *"Were they teaching electronic music there?"*

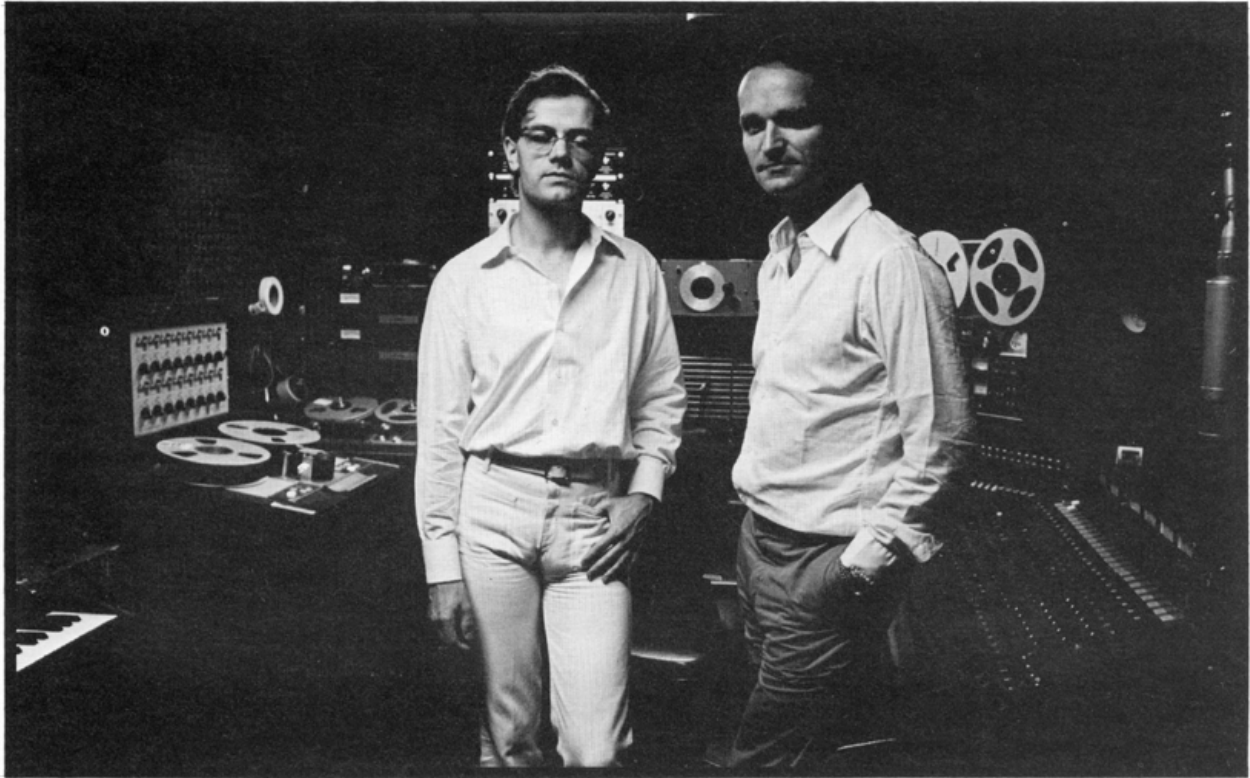

Chris August

“We create loud speaker music, direct loud speaker impact.”

Ralph: “No. It was classical training. What you would call very basic classical training.”

Doug: “When Kraftwerk first started, did you have any problem arranging concerts and having them attended by audiences?”

Ralph: “Yes and no. Germany is very open to new music. It is not like America, where there is strong entertainment thing. Everything in America is measured by its entertainment value. If you do not draw a sell out, then you are nobody.”

“In Germany, it’s not measured this way, so it’s rather for the pure interest people really come and listen and sit down. Florian and I have done some concerts for very long periods, also with close relation to visual arts. We’ve worked with some artists and done all kinds of things like lying on the floor or playing from other positions. It’s not really an entertainment show, it’s an Avant-Garde music scene and the whole scene is very open to anything that comes out and brings some information.”

Bryce: “Why do you think that is the case in Germany, as opposed to

America or other places?”

Ralph: “Well, there’s this cultural tradition. On one hand we have the same that you have with official entertainment. We could say we have this with state music which is classical music supported by the state radio stations and state cultural opera houses. They all get money from government tax. I pay tax and this money is used to produce classical music concerts which might be good but I do not really want to support them but I have to because they cannot exist on their own. It is a dictatorship of the established musical culture but again there is a very strong movement against this with any open new musical culture, so as soon as somebody comes up and tries to do something, then he gets support from very many people who also feel disillusioned with this repeating classical operas over and over again for the hundredth year. It’s really of no use at all.”

Bryce: “Do you think Stockhausen had a lot to do with the way the Avant-Garde developed.”

Ralph: “Yes, but it’s not just one

person that stands out in the general spiritual movement/attitude.”

Doug: “Is Europe on the whole generally open to this sort of music?”

Ralph: “Well there is always the chance for outsiders, because it is not so big. You travel for one hour then you come into a completely different country. We live a half hour from Holland and Belgium. If you travel another hour, you go right into France. So it’s a mixing of different cultures on the Rhineland and this makes possible for different spiritual things to happen.”

Doug: “Have you found yourself being influenced by this cross culture availability?”

Ralph: “I think yes on the conscious level but also subconsciously from our general history and kinetic existence. My passport says I’m a German but in reality, the Rhine where we live has been German, has been Rumanian, French, has been Dutch, even Russian. The country has been taken over and over again by different cultures so we are really like a cultural supermarket.”

Doug: “Do you normally in the
continued on page 24

SERGE MODULAR

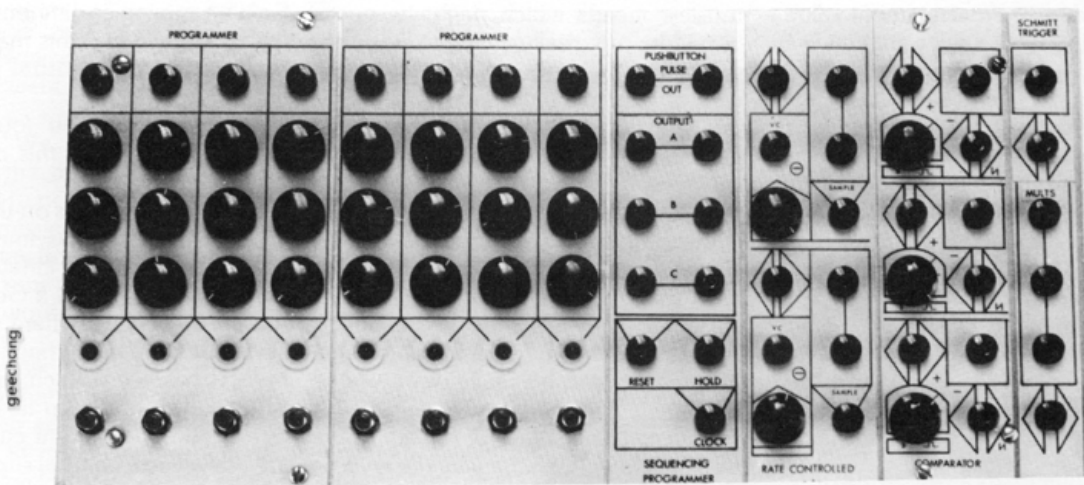
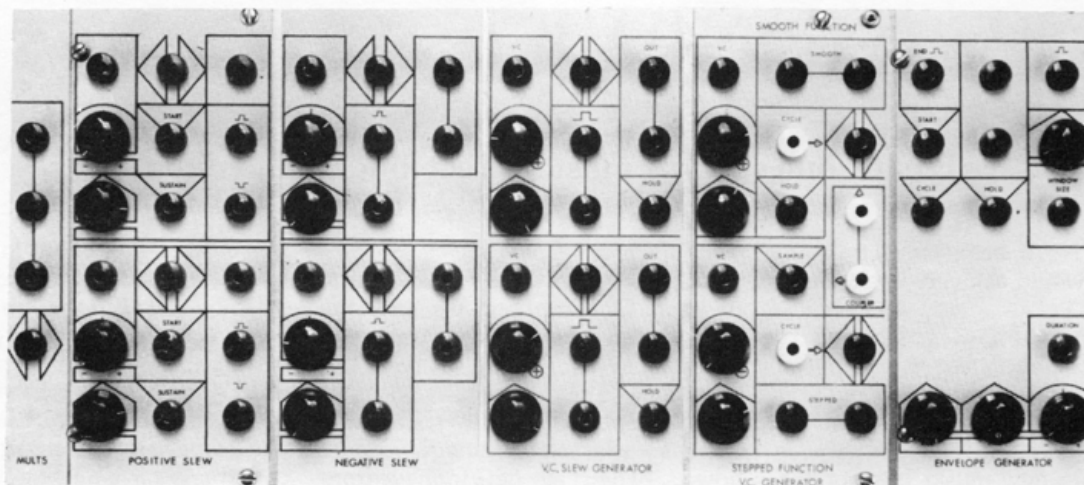
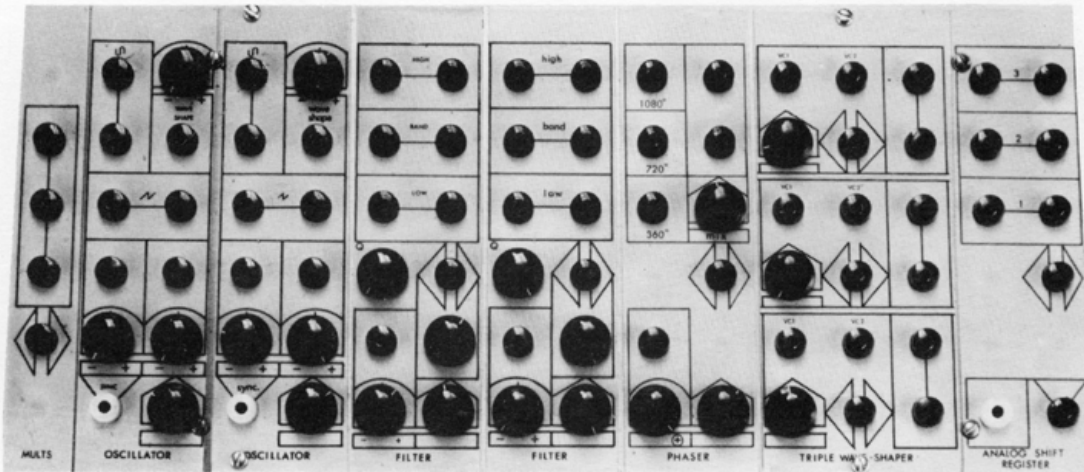

geechang

MUSIC SYSTEMS

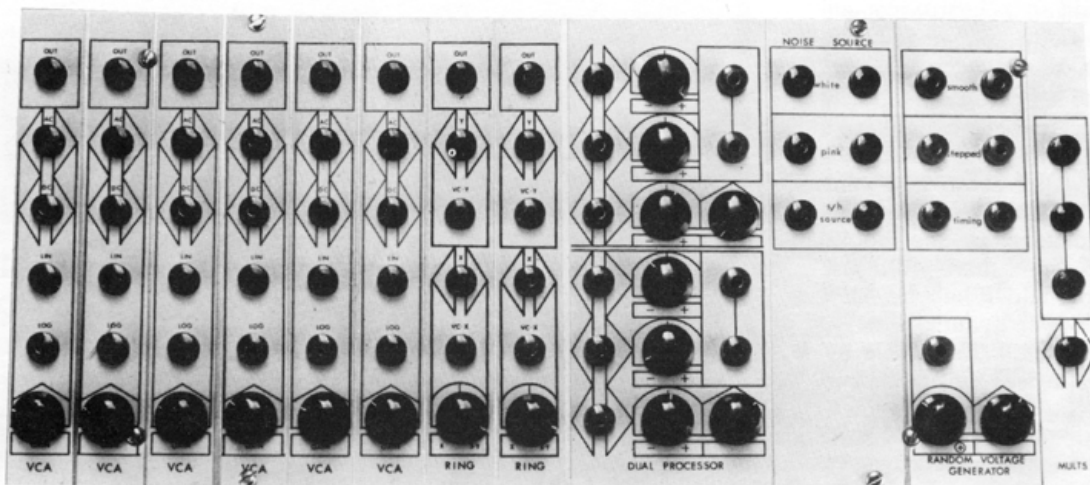
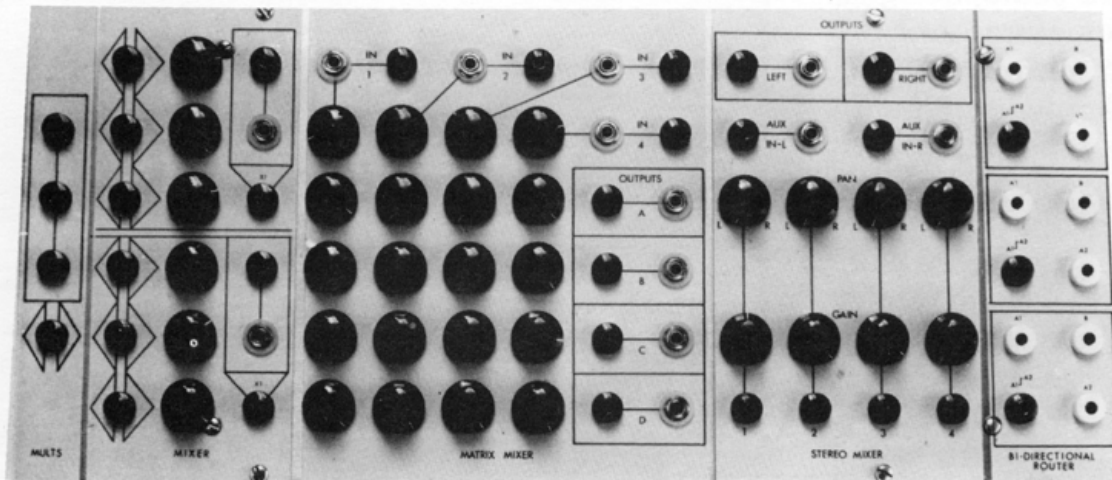

The Affordable Studio Music Synthesizer

THE SERGE MODULAR MUSIC SYSTEM represents the state of the art in voltage controlled electronic music equipment. A large selection of modules is available, many of which feature multi-functionality not found on any other system. All systems are made to the specifications of the purchaser and are available either in kit form (with preconstructed P.C. cards) or fully

built and tested at the factory.

THE SERGE SYSTEM is affordable. Module for module, one of our systems costs less than half the cost of a comparable commercially available modular system. Send us a dollar for our newest catalog (refunded with your first purchase) or call 213-461-7987.

SERGE MODULAR MUSIC
1107½ N. WESTERN AVE.
HOLLYWOOD, CA. 90029

Oberheim, a computer engineer of 13 years, designs and manufactures one of the first commercially successful polyphonic synthesizers. Oberheim discusses his design concepts, motivations, and opinions on the electronic music world around him.

Synapse: "How long have you been involved with electronic music?"

Tom Oberheim: "My company was started in the fall of 1969 when I decided to earnestly go into business building ring modulators. I had a friend who was the leader in a rock band and one day she asked me, "Why don't you build us a ring modulator?" I said that I didn't know what that was but that I'd look into it. I didn't know much about electronic music then. I wasn't involved with it when it first started. I went up to the UCLA library and went through books and magazines looking up ring modulators. In the books where I found them, there were just circuit diagrams, and I had no idea what to do with them in audio. Finally, I found an article, a 1960 article by Harold Bodie. It was on electronic music equipment; really a very interesting article for the day, it discussed modules and ring modulators. So I went home, hooked it up and it worked! I showed it to a friend and he loved it. He played the piano through it and it freaked him out. I built a fancier one that had a built-in oscillator, somebody else saw that and they wanted one too. Then finally, the word got around to one of the big movie composers. He called me and said, "I want to use your ring modulator for the soundtrack of *Beneath the Planet of the Apes*. I took the ring modulator into the movie set and several of the musicians playing in the orchestra saw it and wanted one also. So because of all this, I started the company."

"Although the company started in 1969, I continued working as a computer engineer for a few more years because it certainly didn't support me in the beginning. I started computer engineering in 1959 and all together

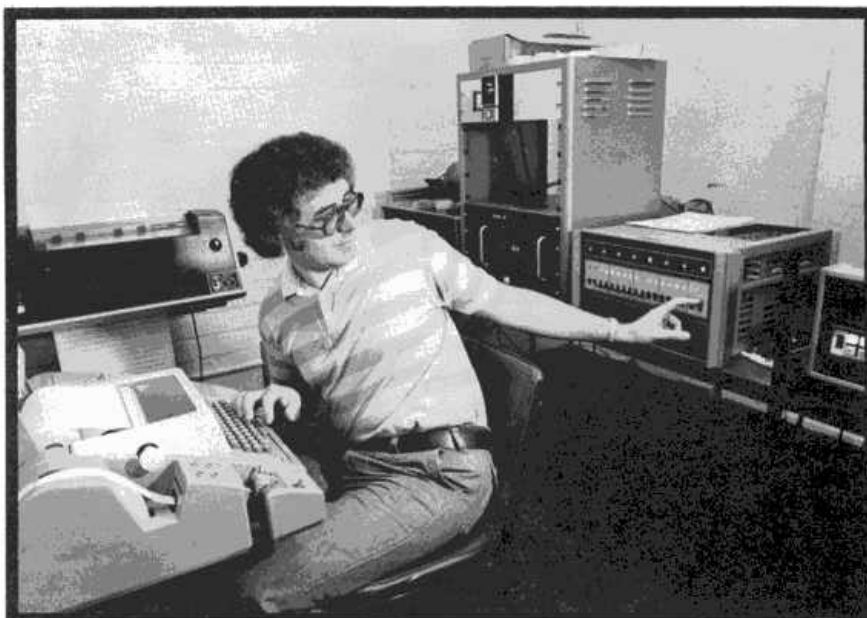

Bill Matthias

AN
INTERVIEW
WITH
TOM OBERHEIM
founder of
Oberheim Electronics
with
Cynthia Brett Webster

I've worked as one for about 13 years. People keep asking me about computers and synthesizers, but I'm willing to wait until I see what possibilities really develop in that area. That area, oddly enough, doesn't interest me too much yet."

Synapse: "Why is that?"

Oberheim: "Because I don't see any fantastic potential in it. Only now is the potential being realized but only in an automatic patching sort of way."

Synapse: "Are you a composer?"

Oberheim: "No, I've never really sat down and composed anything. I had all my degrees in physics, but I also have about three years toward a music degree. I was in the music department at UCLA for many years."

Synapse: "What was your instrument?"

Oberheim: "I was a choir singer. I didn't play an instrument at that time. I did do some performances for a while though. When I built the first ring modulator, I showed it to a very close



Bill Matthias

“I build synthesizers because it’s such a fun thing to do. I’m not convinced that they’re going to take over the world. I enjoy it from a technological sense combined with the gratification of seeing something I build being used musically by a musician.”

friend of mine, Richard Grayson. He’s a composer, performer, and an incredible keyboard improvisationalist. He came over to my house one afternoon, I hooked the ring modulator up to the piano and he played a couple notes and a couple chords then he just started playing this new instrument instantly. I had a pedal hooked up to the ring modulator so that the ring modulator could be varied. On preceding evenings, I hooked up my Revox tape recorder to get some tape delay and tape echo effects. That added to the whole thing and Richard was composing on the spot while I’d fiddle with the echo and other stuff.”

“At that time, Richard was starting to put on these noon concerts. Finally on one of these concerts, we did a little

electronic piece together. We had a couple speakers, I hooked the ring modulator up to the piano, had a little tape delay and people loved it. We actually had pieces where there was a lot going on by the both of us, I wasn’t just bringing up the gain. Richard would play a chord and I’d add echo or some kind of reverb. He would react to that and then I’d react back; we really had fun. That went on for three years. Richard continued with them, and he has just given his seventh annual concert, so we started this seven years ago. I considered myself a performer because of what Richard and I did. I’m certainly not a composer, and I’m not actively a performer anymore, I just build equipment now.”

Synapse: “Right now, you are one of the few polyphonic people on the market, out of maybe five or so at the most...”

Oberheim: “Yes, there’s EMu, Oberheim, and Moog has the Polymoog, which is not completely a synthesizer but a polyphonic instrument. Moog has ten or fifteen pre-production prototypes that they’ve let artists use to get feedback on. It’s not a voltage-controlled synthesizer as we normally speak of it, but it’s a fantastic keyboard instrument, there’s no question about that. There have been some one-of-a-kind polyphonic synthesizers here and there. Now of course, Bob Easton is certainly in the polyphonic business, but not from a keyboard point of view. His guitar synthesizer is last but by no means least. I would like to think that Oberheim is the forefront of the polyphonic market. I’m convinced that this position is going to be very short-lived. Judging from the reactions of musicians that play synthesizers, I’m sure that more polyphonic machines will be here shortly.”

Synapse: “Do you think that polyphonics are what we are really striving for?”

Oberheim: “No, it’s just another sideline. On my machine I like just playing it monophonically, then flicking a switch and going to polyphonic. It’s just a totally different instrument.

“A lot of us who started out just scratching away at electronic music learned a little, and learned a little more, and built it up slowly. Design-wise, Dave Rossum, the president of EMu, is close to being a genius. Three years ago, I don’t think Dave even knew anything about synthesizers. He was a Cal Tech graduate with a biology degree who got together with some people and they built a crude synthesizer. A year later, he’s designing the best.

“Dave wrote an article in *Electronotes* on the problems of the polyphonic keyboard. The two extremes of monophony and polyphony are a voice. A single-voiced synthesizer — ARP 2600 or a typical Moog or any other, has basically one VCA and one filter. The oscillators aren’t the limiting factor. It is the VCA that is the ultimate limiting factor, even if you have just one voice or many voices. Usually you

continued on page 26

The Star Making Machinery: ... Larry Fast Talks About Synergy

Synergy is a property of any reaction where the sum exceeds the combination of the parts. A metal alloy which is stronger and more durable than any of its component parts is an example of Synergy. So would a recording done on 16- or 24-track recorder that ends up sounding like a 150-piece orchestra. That is why I adapted Buckminster Fuller's central physical-ecological theme to my music.

Going back to 1971-72, I became acquainted with the members of Yes while doing a college radio interview. Around this time I was becoming involved in my own electronic music design and was asked to build some custom modules for Rick to use. These modules were used in concert and ap-

peared scattered through most post-Fragile Yes albums, though they got their best workout on the "Six Wives" track on Yessongs.

In the Winter-Spring of 1973, I formed my own group, Essence, an American progressive space-rock band. We recorded our demo tapes and I brought these with me to England in the Summer of 1973. I was given much help in getting through record company doors by Jon, Rick and their manager Brian Lane. Though Essence never worked out as hoped (a Warner Brothers demo of an almost complete album exists), Synergy probably would have taken a lot longer to happen without their original push for Essence. Synergy is directly descended from the business contacts

and musical inspiration provided by Yes.

John Anderson and Rick Wakeman had no direct connection with any aspect of the writing or recording of the Synergy album. My thanks are extended to them though for helping me to get started in the business end of the recording industry.

From July through December 1974, I recorded 4-track demo versions of all the material on a TEAC 3340 recorder. These started as small sections which eventually were revised and expanded into the original pieces that appeared on the first album. During the latter part of September, in a fit of frustration, I recorded the entire length of "Slaughter On Tenth Avenue," one of my old favorites, just so that I could have a complete piece of electronic work under my belt. Producer Marty Scott liked the piece so much that we decided to use it on the LP. Following the demo version of "Slaughter," the other pieces began to fall into place. During December, I recorded timing and reference tracks at home to be dubbed onto the 2-inch 16-track master.

All track recording was done at House Of Music Studios in West Orange, N.J. I did all recording using my own synthesizer equipment set up next to the control room board so that I could act as engineer and tape-op. The recording was done using Ampex 406 2" tape on an MCI 16-track machine connected to an MCI 18 in/16 out board. DBX noises reduction was used. All instrument lines were, of course, direct. Recording was fairly unaltered except for some UREI compression on the mellotron.

Since it became imperative that a computer mix be done, it also became necessary to do a tape transfer to convert DBX noise reduction over to Dolby A. This was done at Bearsville Sound in Bearsville, N.Y., using two Ampex MM-1000 16-track recorders

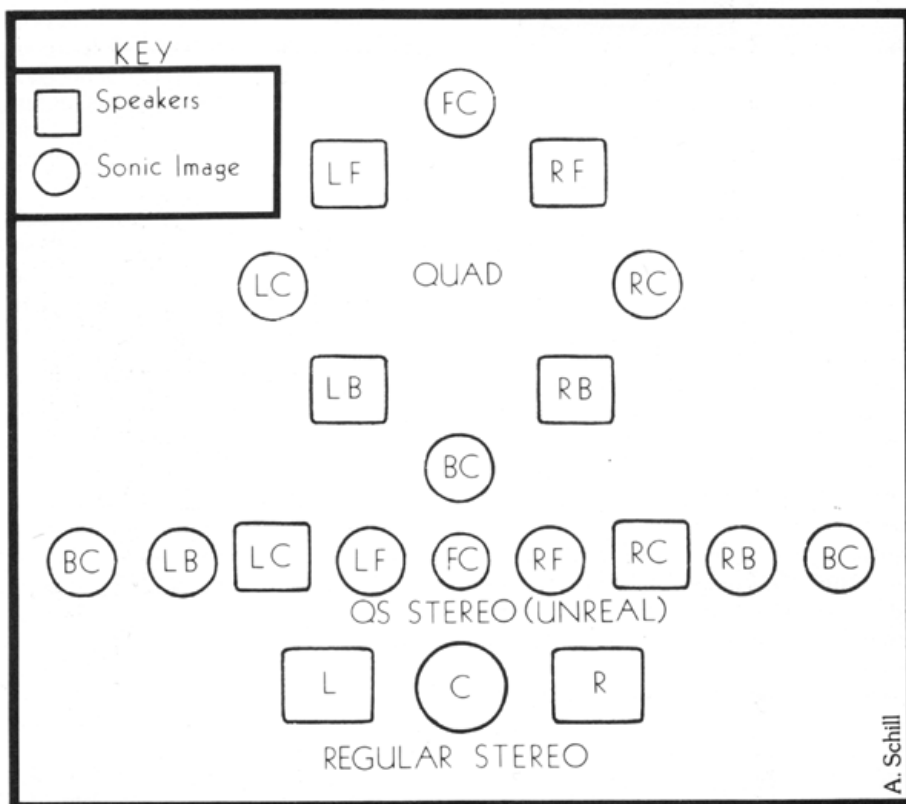

Comparison of regular stereo sonic image location and QS stereo (QS) quad sonic image.

with the appropriate noise reduction devices. The copy was onto Scotch 250 2" tape.

Mixing was done at Media Sound in New York. It was the first mix done on the API/Allison 32-input computerized mixing board at Media. The playback machine was an Ampex MM-1100 24/16 track; Mixdown was in quad with a simultaneous QS encoded two-track master (from which the LP was cut) and four-track 1/2" discrete version made for safety purposes and Q8 cartridges. The mix was monitored on the quad sets of both Altec studio speakers and KLH home speakers. The mix was onto Scully two- and four-track machines. Mastering was done at Sterling Sound in New York by Robert Ludwig using the two-track QS, Dolby master mix.

Many people are curious about the special equipment used on this album. One of these is the Galvanic Skin Response Voltage Controller. More questions have been asked about this toy than all of the other instruments put together. It is a custom device that I built which sends a small current through the player's skin. Varying the pressure of any skin surface on a pick-up plate causes variations in skin reactance causing a corresponding change in the controller's voltage output. It is surprisingly easy to control. When patched for VCO pitch control it gives sweeping frequencies much like a ribbon controller.

The Oberheim Expander Module, another piece of special equipment, is a nice little box made by Tom Oberheim in California, which has two voltage-controlled oscillators (VCO's), two envelope generators, one low-frequency oscillator (LFO), one multi-mode voltage-controlled filter (VCF), and a voltage-controlled amplifier (VCA) which can be wired into a standard Mini-Moog or directly to Oberheim's sequencer. The expander module was used mostly to get more sound out of the Mini-Moog onto a single tape track rather than having to use several multi-tracks of the Mini to get the same sound. The expander was a great help in organizing the most economical use of the 16 tracks available.

Oberheim's DS-2 Digital Sequencer is another magic box that serves as a control voltage and timing memory

using computer memory techniques. When properly wired into the existing Mini-Moog circuitry, the DS-2 will "remember" up to 72 events (notes, triggers, filter changes, etc.) on command, and play them back as needed. On playback, voltage outputs can be varied to provide several octaves of transposition, and the timing can be speeded up or slowed down by a factor of several thousand times. This is one of the most advanced pieces of synthesizer hardware on the market today. It also is one of the first commercial pieces of digital equipment which will most likely gradually replace our current analog-based synthesizer designs over the next five to ten years.

The 360 System's 20/20 Frequency Shifter, another magic device, has input and output jacks and a large control knob. If a signal is applied at the input, the control knob can be adjusted so that the output will appear the same, except shifted up or down in frequency by up to 5000 Hz. Great for turning a baritone into a soprano or a set of bongos into timpani. On *Synergy*, I used it mostly for its built-in ring modulator circuit rather than its frequency shift capabilities which are more suited to working with conventional instruments.

The Mellotron is the standard 400D with the usual flute, strings, and cello tapes. It actually appeared on only about 4 to 6 percent of the total tracking on the album since most of the time synthesized strings and flutes are much cleaner and crisper than the Mellotron's primitive tape playback systems. (All Mellotron sounds are controlled tape playbacks of conventional instruments rather than totally electronic sound generation as with a synthesizer.)

The album was recorded in Quad. After looking over the several quad systems available, QS seemed to meet most of the requirements for releasing the record in quad better than the other systems. For a start, it is completely compatible. All of the *Synergy* records are quad; there is no separate stereo release. If you bought it at all, you bought it in quad. The QS quad plays in quad, on a stereo turntable with no damage to the record, and into mono with no problems if the mix was done right. QS broadcasts on FM with all quad encoding intact. It costs no

more to press the records than stereo; and with Sansui's Variomatrix quad decoders it gives up to 20 db separation in all directions (which is damn good). It also does a neat little trick with stereo image when played back in stereo by spreading the stereo channels out wider than the speakers due to the phase encoding used to differentiate the four channels. (See diag.)

As a postscript, I might add a note about the back cover of the album, which has attracted many comments. It is an infrared color photo done without any filters of an old (ca. 1955) Brook hi-fi power amplifier. The amplifier puts out a whopping 10 watts which was considered pretty powerful back then for a home unit. For the photo the tubes were all polished up and the amplifier run in a dark room for an hour or so. A series of photos were taken from different angles and with a variety of exposures. The one finally used was taken with a Nikon F camera with a standard 50mm lens with a +1 diopter. The exposure was about 55 minutes at f. 16 on Kodak Ektachrome Infrared film.

expert
SYNTHESIZER
programming
and
instruction

STATE-OF-THE-ART EQUIPMENT
(213) 463-8772

Constructing An Arabesque Generator ... The Analog Shift Register

by Arpad Benares

In the Serge Modular Music System, the module called the Analog Shift Register (ASR) performs the invaluable function of providing a simple means of creating arabesque-like forms in musical space. Arabesque is a word often applied to oriental arts to describe the travel in graphic space of two or more like forms, for example: leaf with leaf, vine with vine, etc. in a perpetually intertwined manner.

Fig. 1

Contemporary musical examples of arabesque-like forms can be found in the music of Terry Riley, where they arise through the combining of modal-melodic riffs with their tape-delayed echoes. Oriental and Western musical traditions offer an incredible variety of examples of similar or related forms of the process of arabesque: accompanied melody (homophony) as in Chinese music, inter-locked motives as in Javanese music, the canonic and motivic forms in Western music, etc. . . . What is the ASR? The Serge System catalog description runs as follows: "The Analog Shift Register . . . is a sample and hold with a twist. Whenever pulsed, the previously held voltage is sent down the line of three outputs, yielding thereby the electrical equivalent of canonic musical structure. A special pulse output permits linking two or more ASRs together to form longer units." To give a musical example of this operation, let's assume that the voltage output of a keyboard is plugged into the analog input of the ASR, and the keyboard's triggers used to give sampling commands for the ASR. Furthermore, assume that the ASR's three outputs are patched into three oscillators.

Fig. 2

The results of this patch are shown below, both in terms of voltage levels and hypothetical musical tones:

Fig. 3 + Fig. 4

Replacing the keyboard's trigger by a pulse generator (clock) yields an effect very similar to "accompanied melody," since all ASR-controlled

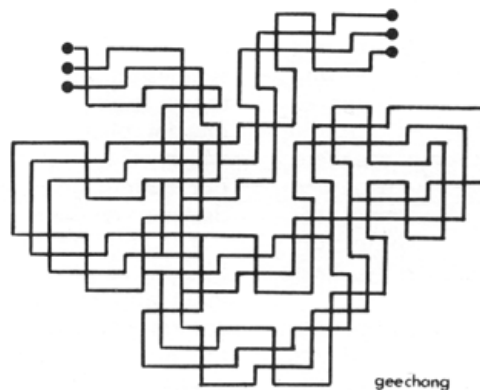

Figure 1: An arabesque design



Figure 2.

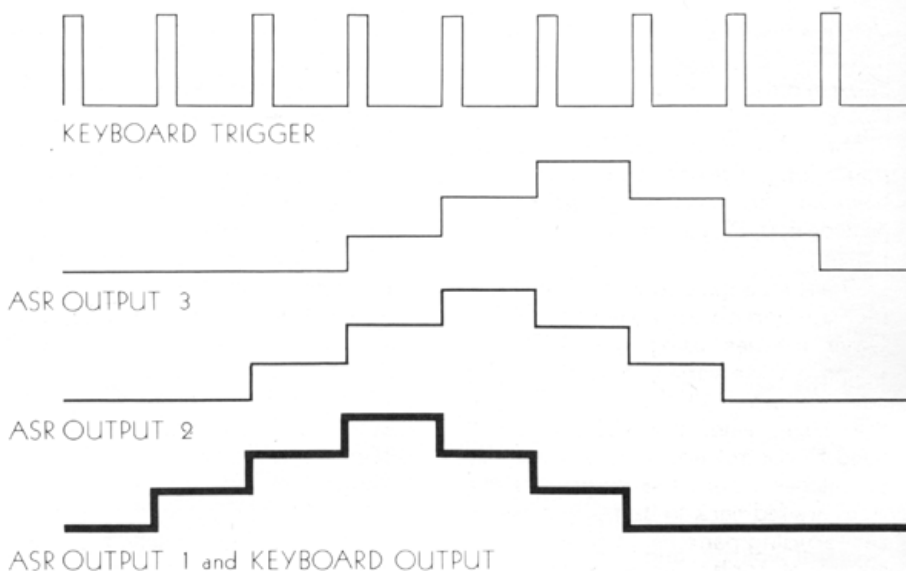

Figure 3.

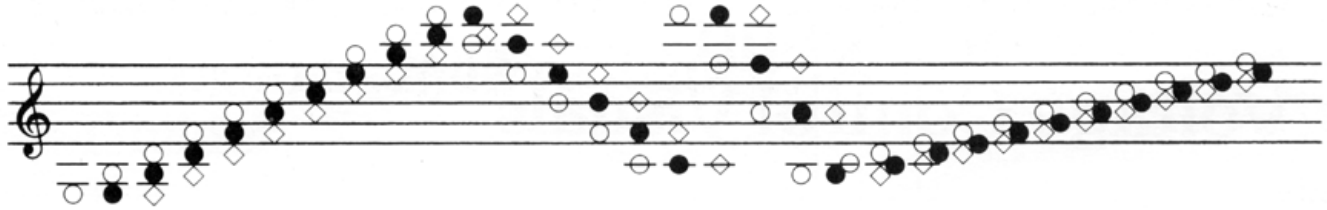

Figure 4.

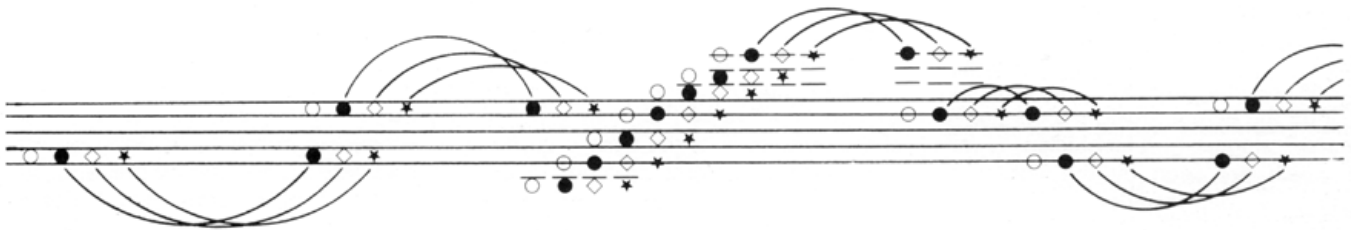

Figure 5: ASR effect with four voices.



-Clock.



-Two of the four voices in conventional notation.

Diagrams: A. Schill

VCOs always end up on pitch with, however, a staggered and variable delay in time:

Fig. 5

The basic ASR module is three stages long. Two or more ASRs may however be hooked together to provide 6, 9, 12, etc., stages

Fig. 6

These examples show the most elementary and obvious use of the ASR. Other patches using the ASR can obtain a wide variety of patterns, for example, when VCOs are not used at the unison, when the ASR's output is used to control envelope slopes, and in patches where the outputs of the ASR are fed back to its input to create self-recycling patterns. In general, as a source of control voltages, the ASR will perform many of the effects obtainable with an Echoplex or digital

delay line, but it has many exotic quirks of its own.

How does the ASR work? Basically it consists of a string of three sample and hold circuits which are sampled sequentially last stage first. In operation, S/H-3 is activated first and acquires the voltage held at SH-2; S/H-2 is then triggered and acquires the voltage held at S/H-1, thereupon S/H-1 is triggered and acquires whatever voltage is present at the ASR's input. This process is performed very fast (about 3 Ms.). The S/H circuits consist of bi-directional gates (CD 4066) configured for minimum leakage, feeding storage capacitors (10,000pf.) read by voltage followers (CA3140s). The triggering circuit consists of a monostable and two half-monostables in series (pulse widths of 1 Ms.) with the remaining amplifier of

the quad op-amp (LM3900) being used to provide an end-of-cycle pulse suitable for hooking ASRs in series. The diodes in the schematic function to drop the 12V. power supply voltage to about 10V. which is optimum for minimum leakage of the S/H circuits. Operation off a 15V. power supply is feasible by replacing these diodes with a 4.7 V. zener diode. Note here that the ASR works only with positive voltages from zero to about 8 Volts.

Fig. 7

Construction of the ASR is relatively straightforward. The critical points of the circuits is the meeting point of the gates, storage capacitors, and the voltage followers (pin 3, CD 3140). These points ideally should have a guard band connected as shown in the schematic (to counteract stray leak-

continued on page 30

Light With Sound . . . Voltage Control Visuals

by Alex Cima

The artistic collaboration between electronic musicians and visual artists often yields surprisingly synergistic results. Broadly defined, visuals may include the actual musicians on stage, dancers, singers, and technicians . . . all of which are seen by the audience during a performance; given the nature of tape concerts, musicians on stage adopt the characteristic of "visuals." In a narrower sense, visual elements include film, film with score, rear projections, slides, and sound sculptures . . . all of which are usually not subject to voltage control. Now technology such as lasers and voltage controlled equipment forecast a new era of increased cooperation between auditory and visual artists.¹

Scriabin's last orchestral composition called for piano, organ, chorus, orchestra, and color organ (Prometheus: The Poem of Fire). However, not until the dissemination of electronic concerts throughout the world, has the adoption and concern of a visual element become a crucial factor. Sound sculptures may involve the simplicity of a structure small enough to be carried by one person, or the complexity of a Nicholas Schoffer work such as the 150-foot cybernetic tower for which Pierre Henry wrote a score in the 1950's. The Los Angeles Triforium is an example of a far more complicated structure for which the "performer," in addition to music skills, must possess knowledge of computer programming in order to run this exotic sound producing sculpture.

In view of the strengths of voltage controlled equipment, compatible visuals: those which could be subjected to voltage control of some parameters of the visual product offer unique opportunities. A familiar example is the color organ predominant around the 1960's and popular in discos, where the glow of the colored lights follows the amplitude of the music.

These type of visuals are commercially available and are generally quite expensive considering their function.²

A relatively simple voltage controlled visual is a neon laser beam projected on a small mirror attached to the cone of a speaker, when the speaker is activated the push and pull of the cone reflects the light in such a way that the patterns created on the wall or screen follow the sound. More elaborate designs such as Laserium incorporate tape and voltage control devices which operate on similar principles, but are far more sophisticated and expensive since they utilize a multiple color laser system. The recent Exploratorium show in San Francisco offered a number of unique sound/visual works.

Two voltage controlled visuals used by LEM are the Electro-Rotary Optical Sculpture (EROS) developed by Courtenay Heater and Jim Yurchenco, respectively, an engineer and sculptor from Stanford University. These instruments consist of a tripod on which are secured a motor and an arm about 40 cm long, the arm rotates like a fan at a rate of 10 Hertz (600 rpm); at the tip of the arm, a ping pong ball with a xenon lamp inside will flash when energized by a pulse wave. The oscillator can be one built in the system or one from a synthesizer . . . the rate of flashing will depend on the rate of the vco, the pattern produced by these flashes depends on the rate of the vco, its waveshape and modulation products, and the rotation of the arm. In a darkened room, once the arm is rotating, flashes can be induced to create a spherical object rotating against a dark background, when the rate of the vco is increased, fusion (similar to the effect created by motion pictures) will create several interesting patterns moving in space. These patterns are now being placed under micro-processor control so as to develop a dictionary of patterns which can then be easily retrievable during a performance. The color assumed by

the ping pong ball depends on the bulb, and in this case they have chosen a bright orange . . . phosphorescence created by the ball adds a dramatic blueish/green trail to the pattern. The diameter created is approximately 60 to 70 cm, the circular pattern often distorted by the eye into an ellipsoid . . . they are currently working on an EROS with a 1.5 meter diameter.

Another voltage controlled device is a photoresistor patched to the triggering device in a synthesizer. When light of the appropriate intensity hits the photoresistor, an envelope is triggered allowing whatever is patched into the vca to be heard . . . LEM uses this device to trigger programmed source material from a distance, by darkening the room and using special flashlights with a powerful collimated beam.

The coming video revolution parallels the development of computer music. Several video systems have been designed with music in mind. For example, the video synthesizer built by Electronic Music Studies, London, or the video systems developed by Nam June Paik. Color, shape, modulation, and integration of previously recorded images are now possible. Such systems prognosticate an incredible development in the integration of audio and visual arts. In the near future, video and sound synthesizers may well be common sights at concerts. The computer graphics developed by John Whitney prove that the future has a clear area waiting for the full exotic use of the digital computer as the ultimate sound/visual instrument.

¹ Mumma, Gordon. "Live Electronic Music." In J.H. Appleton and R.C. Perera (Eds.) *The Development and Practice of Electronic Music*. New Jersey: Prentice-Hall, 1975, pgs. 286-335.

² Roctronics, 22 Wendell St., Cambridge, Mass. 02138.

Build It: A Seven Stage Frequency Divider

by John Blacet

This simple circuit will produce seven octaves of square waves below the input frequency and allow you to select which ones you want as well as mix them with the regular output. This is accomplished with a single low current CMOS I.C. along with a few other components. The square waves are a pleasant sounding 50 percent duty cycle.

Although the instructions here are for the PAIA "Gnome" micro synthesizer, it should work with any other device having a square wave above ground available. More on this later.

The circuit works by taking the VCO square wave directly from the collector of the transistor producing it, and dividing it by 2, 4, 8, 16, 32, 64, or 128. These are selected by the dip switch and attenuated by the miniature pot before being fed back into the VCA.

If you want to add the frequency divider to another synthesizer, connect it internally to the square wave source. The CMOS device requires direct coupling. You can also use a schmitt trigger between your VCO and the frequency divider. The Cd 4024 will operate from 3 to 15 volts.

Construction:

1. Remove the top section of the Gnome. Carefully drill and file holes for the pot and dip switch as shown in the photo (Fig. 1).
2. Using the pattern shown (Fig. 2), fabricate the p.c. board. Resist lacquer or pen is the simplest method. Etch the board and drill component holes.

3. Observing polarity of capacitors and I.C., mount components on the board and solder, using a 25 to 35 watt iron and rosin core solder.
4. Connect a 4 1/2" wire to the p.c. board +9. Also a 5" wire to VCO in, and a 3" wire to VCA out.
5. Because space is limited inside the Gnome, it's a good idea to wire the p.c. board, pot, and switch together outside.

The miniature pot will mount with the lugs oriented toward the dip switch. Connect the top lug to the p.c. board ground. Also attach a 2" wire to the top lug. This will attach to ground at lug 5 of TSZ. Connect the center lug of the pot to the p.c. board (Fig. 3).

continued on page 31



Figure 1: Gnome with pot and dip switch.

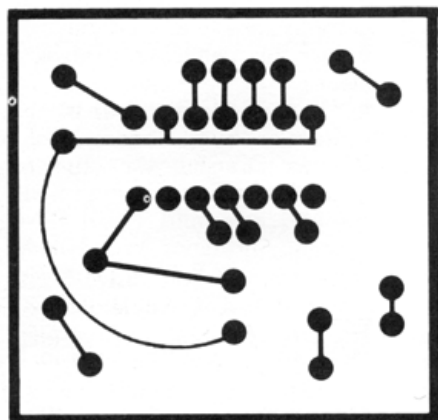

Figure 2: Foil side of p.c. board.

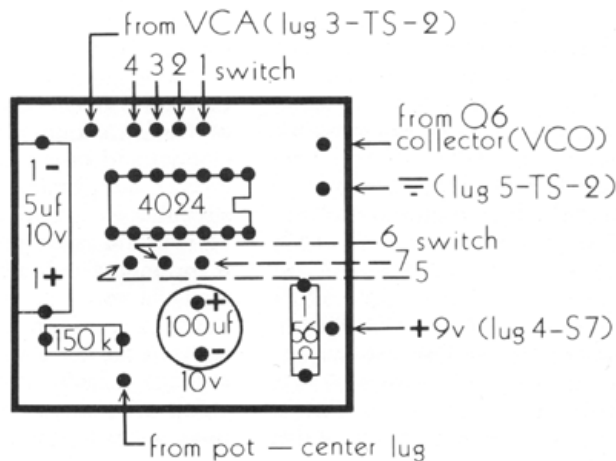

Figure 3: Top view.

Diagrams: A. Schill

PERFORMANCE REVIEW

A Concert of Avant-Garde Compositions by Jasun A. Martz with the Neoteric Orchestra July 16th, at the Brand Library in Glendale, California.

Before the concert began, Jasun Martz introduced himself to the audience and briefly outlined some of his performance techniques. In his compositions, Martz aims more at the development of esthetic sound rather than the achievement of a perfectly noise-free audio.

This technique was apparent in the majority of his tape pieces, but would not be considered bothersome at any time because of its conceptually correct usage. In one specific piece entitled "The Box," a very noticeable amount of hiss was combined with a traditional German music box tune that had been scrambled piece by piece using tape overdubs.

The first half of this two-hour concert was devoted mainly to tape pieces, produced between 1971 and 1976. These were: "The Audience 1," "I (I think I know exactly what I think I know)," "Ha-Wa," co-written by Martz and Bill Bottrell, "Perimeters," "The Box," "Sears," and "The Verge."

"I (I think I know...)" consisted of one male (bass voice) with one female (treble voice) seated facing each other, while a twenty-foot tape loop spun around them. The two performers spoke into separate microphones which recorded their voices at intervals on either of the two loop threaded machines. All sounds on the tape were recorded live during the performance and the effectiveness of the piece relied on the performer's exact timing and articulation.

The second half of the concert consisted of two other tape pieces, "Ecneidua," and "The Audience 2" along with one very good piece titled "The Pillory" performed by Martz and all 15 members of the Neoteric Orchestra. This piece was by far the best work of the evening compositionally, and performance-wise, it was very tightly rehearsed. At many points during the orchestra's tutti sections, I had the suspicion that the auditorium would



explode at any minute because of the extreme force inside. Although these sections were quite loud, "The Pillory's" real effectiveness lay with the sheer intensity of layers upon layers of percussion, choir, mellotron, horns, woodwinds, synthesizers, and strings.

"Pillory" began with Martz on mellotron playing a melancholy motive in a minor key, while being accompanied by John Luttrell on synthesizer. After developing this theme melodically, Luttrell and one of the percussionists switched to wind hoses, and Martz moved to the baby grand piano adding some very nice atonal arpeggios. Little by little the rest of the Neoteric joined in, producing overall a very good rhythmic interplay between piano and orchestra similar in style to the works of Ginastri. Luttrell then moved to clarinet and began playing a beautifully lazy, very bluesy solo. One of the saxophonists joined him, then Martz on soprano sax, then another sax and a trumpet. Gradually everyone came in while some sample and hold was interjected into the sometimes quiet spots. After the last of about eight tutti sections (which seems to be the Neoteric's specialty), the music returned once again to low volume with some players using finger cymbals to accompany the vocal clusters and Martz's

initial melancholy mellotron motive.

For this piece, Martz seemed to use the string section (consisting of two violinists, one violist, and one cellist) a bit sparingly, orchestrating them in chiefly for augmentation. This in turn made the music very thickly textured. During one of the last crescendos in "The Pillory," one of the percussionists got so enthusiastic that as he was playing, he knocked his metal thunder-sheet right off the frame and onto the floor adding an interesting improvisational crash.

Martz shows an intelligent approach compositionally and an effective technique for getting his ideas across visually.

The Neoteric Orchestra is:

Vocals: Sue Reed, Jeff Taylor, Warren Ormsby, Dan Esteras, and Cinde Martz. Saxophones: Brian Floyd on alto sax, and Mike O'Neal on soprano and tenor. Woodwinds: Mike O'Neal on alto flute, and Francie Dellefave on flute. Strings: Karen and Teri Dellefave on violin, Dave Henry on viola, and Bill Bottrell on cello. Percussion: Byl Carruthers and Don Swanson. John Luttrell played synthesizer, electric piano, and clarinet.

Jasun Martz played piano, electric piano, recorder, soprano sax, and mellotron.

- Angela Schill

ALBUM REVIEWS

Evening Star by Robert Fripp and Brian Eno

Island Records HELP 22 Import

Side One: Wind on Water; Evening Star; Evensong; Wind on Wind.

Side Two: An Index of Metals

Turn of the century French Impressionism and electronic drone music are the major influences in this second collaboration of ex-King Crimson Robert Fripp, and ex-Roxy Music Brian Eno.

The album opens with "Wind on Water," a group of synthesizer tape loops, forming a drone that breathes like calm ocean waves, very serene. In fact, the result is very much the same as that created by the opening glissandi of Ravel's "Daphnis and Chloe"; similar chordal composition, all sorts of synthesizer sequenced twinkles reminiscent of piccolo trills, a similar palate of timbres.

This dissolves to "Evening Star": arpeggios played by Fripp on guitar and then looped by Eno; to which Fripp plays a cello-like fuzz guitar, at times through a tape delay. The background loops change gradually adding synthesizer and piano parts to create a continuously moving cloud of sound, all consonant and very soothing.

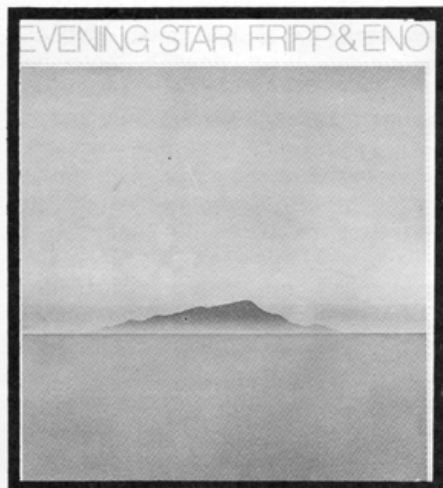

Side two, "An Index of Metals," is a bit more harsh. Where the waves are calm on side one, they are choppy on this side. There is dissonance and more tension here. I hear perhaps a train station where all the engines are

fired up but the passengers are still boarding. The structure of this side is the same, sound loops dissolving into each other — synthesizers (synthi/ AKS), guitar, pianos ... but the psychological effect is more intense.

Anyway, this is a nice change of pace; a good album for spacing out and losing oneself in the drone zone.

- Danny Sofer

Pieces for Kohn by Tom Hamilton

Somnath Records KH 120

Side One: Modhera, Bonampek

Side Two: Girnar, Fatehpur

On side one, Modhera opens into an unrestricted space ornamented with bell-like events, effectively and naively interacting in time. Repetitive events limit the space until it's compressed to such an extent, that the core explodes in the opposite direction hurling you through an ever widening space.

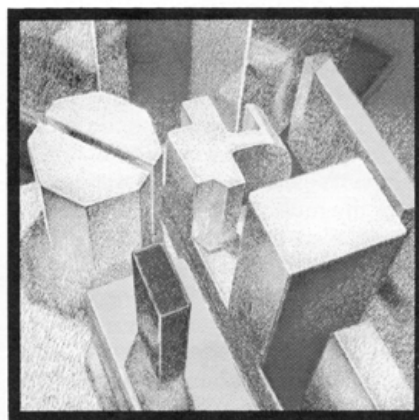

The composer of *Pieces for Kohn* is Thomas Hamilton; he is the director of Washington University's Electronic Music Recording Studio.

When I first got the album, I mentioned it to a friend who remembered a concert in the midwest where the audience applauded enthusiastically for a piece by Hamilton before the piece was actually over. The tape machine operator felt the drama was so complete that he shut the tape off without playing the rest of the piece. It may be that Tom's frustration at that point influenced the second cut on the album.

Bonampak is a collage of wildly

rhythmic sounds, both schizophrenic and disjointed. Layers are added, subtracted, and substituted to such a point that space is an element only in its absence.

Pieces for Kohn manifests itself largely in space and rhythm or the negation of these elements. Timbre, unlike much electronic music, is not a very active element here.

So who is Kohn? Bill Kohn is a painter and printmaker who teaches at the Washington University School of Fine Arts. Four of Kohn's paintings: Madhera, Bonampak, Girnar, Fatehpur, are the conceptual partners to this album. Thomas Hamilton says on the cover: "In each of the four pieces, I have considered expression of both the general style and the specifics of that painting."

As important as these paintings were in the making of the record, it would be helpful to see these works to fully understand the composer's concept. On the back cover is an unidentified graphic, is this Kohn's work?

- Phil Terr

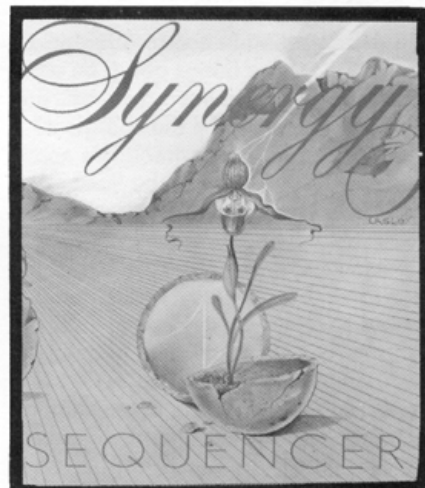

Sequencer by Synergy
PPSD 98014

Side One: S-Scape; Chateau; Cybersports; Classical Gas.

Side Two: Paradox; Part A of Largo from the New World Symphony; Icarus; Sequence 14.

Sequencer is an album of mostly original music by Larry Fast. It also includes two works by other composers, realized by Fast. It is a record that would be of interest to those new to

continued on page 31

More: Kraftwerk
from page 11

shows you're doing now, involve visual arts on the stage?"

Ralph: "We've worked three or four years with Emil Shult. He is a graduate of the Dusseldorf Art Academy. We work together on the composition of lyrics, poetry, sound poetry, and also visually. He does album covers and things we discuss together and work at together, but he's the one who does this actually. And also, projection of pictures. It's not a light show but it's rather static ... sound paintings, we call them sound paintings."

Doug: "Do you have any visuals that are interfaced with your electronics by means of voltage control?"

Ralph: "No, nothing which goes directly but rather it goes through the people. First it goes through a human being, and then into the audience."

Florian: "In the past we have made some comics."

Bryce: "Comics?"

Ralph: "Yes, we also designed comics ... musical comics and we are working this year and maybe we will finish during the end of the year a music book to give instruction and present more aspects of our music than are just possible on record or in a live concert. Things that we have when we talk together, sitting in a cafe or somewhere and all these things going on all the time ... Music coming out of coffee cups or anywhere ... All the sounds in general from the environment. We are working on this ... it might be finished by the end of the year."

Doug: "Could you describe what the comic was?"

Florian: "It's a story with these small plug-in systems trying to get in the inputs and outputs ... trying to make ..."

Ralph: "Contact! In electronics, always you have different components trying to get in contact and form things. It's like people meeting, and we have a story of these small, different electronic components meeting each other and getting together and making up something forming a special group, It's hard to illustrate by talking but when you see it ..."

Doug: "Has this been released publicly?"

Ralph: "Yes, but only part of it and when we have this book together, there will be more of these stories."

Doug: "When you started recording

in your studio, how did you interest a company in distributing your record?"

Ralph: "We did not go to any companies, or anything like this because it was not on our mind but it was rather, we did what we did and we played at universities and old cinemas and art galleries and sometimes we played some festivals. The longer we played, more and more people were coming up to us and handing us business cards saying this or that. We were not really interested in producers or any people that wanted to sell themselves to us, or sell some ideological thing that we should do. We knew right away what we wanted to do so we went to our studios and produced tapes and then later played for some people and they just took off from there. So we produced ourselves right from the beginning. There was never any outside producers or anything like that involved in taking over our lives or our mind, telling us to play in C# or C minor."

Bryce: "Do you still maintain that same freedom now?"

Ralph: "Yes, then when we go somewhere and we have a failure, then we can always say who it was. We can't say it's the fault of the producer so and so, he told me to play in C."

Florian: "It is always our decision."

Ralph: "Yes, we have full responsibility for the music we put on."

Doug: "Recently, I saw in Billboard that Radio Activiity was the #1 LP in France."

Ralph: "For two months."

Doug: "Has it been the kind of success you've been having in general across Europe?"

Ralph: "Well, it's hard to say. It's the first time we've gone to anything like number 1. What does it mean? I do not know but we have always found a positive reaction in general to our music. As I explained before, we do not stand alone in putting this (music) across. There are many people who play electronic music at home and build hobby radios. The Germans have a very strong technical culture and a heavily mathematical attitude which is even brought up in schools, so engineering is rated very high. Many young people make their own radio and speak to their friend next door and things like that."

Doug: "So the whole culture would seem to be a lot more supportive of the music that you're currently making. In this country, there has recently been a radio boom but because of the advertisement that's been done about it."

Ralph: "Yes, in America we find many things are purely rated for their commercial value. A radio station is more than just advertising to me. Maybe it's a very important aspect but if it's the only aspect, it's so boring. It's not worth the time you spend. I mean what is life going to be if you just value these terms? You lose everything else. For one thing, you lose all the rest and you have to reconsider if it's really worth spending 60 or 80 years just looking at one thing. I don't think it is worth it. We don't even consider music the only thing we can do. We do all kinds of things. Everything circles around music but there are many, many aspects."

Doug: "Have you built much of your own equipment or has some of it been bought from commercial manufacturers?"

Ralph: "Well some are from commercial manufacturers, but some things are custom built, some things are rebuilt, and others are just put together from different components which are not meant to be put together that way. We always work with another friend, an engineer who is still in the technical college. It is not the thing itself, it's also the use. Like a microphone. What does it mean a microphone? You can record birds singing or you can record a motor race or you can record the human voice or interviews. It's only a medium. A good electronic music studio doesn't make good electronic music. So that's why we've created this word "The Human Machine" or the "Man Machine" or "Kraftwerk," which it stands for. At one time we are machinery but at the same time we are human. So we're neither simply humans or machines. It's a symbiosis."

Bryce: "Do you think we will become cybernetic. Cybernetic meaning that there will be an interface between electronics and the physical nature of human beings?"

Ralph: "Oh yes."

Florian: "It becomes more ... more ..."

Bryce: "Where do you think that will take us futuristically?"

Ralph: "Well, more . . . maybe more fun. The thing is not to be afraid. I think sometimes people are so afraid. Just scared away and would rather stick to cowboy music."

Bryce: "Do you consider yourselves pioneers in that respect?"

Ralph: "I don't know, but maybe sometimes we're not so much afraid to try something new and just take a risk. I find it boring to go back to 1848 and try to sing about this. I mean, what does it mean today? We are 1976. There are different things in the air today which we have to speak about to have any value at all other than being a living museum."

Doug: "Your album *Autobahn* got to number 5 in the charts here. Was it a surprise that that would happen in this country?"

Ralph: "This is one major turning point in our lives when we first crossed the Atlantic with our electronic equipment. We arrived with some old suitcases in New York City. Before in Germany we went from our studio to some place and then did something and went back out then we went somewhere and suddenly the world was round. It was a different psychological situation too. I think this shows in our music that we have been doing since then. It is another dimension."

Doug: "How do you feel this reflects in your music?"

Ralph: "Well, there is this continuity which we call . . . well, endless you could say. Our new album is called *Europe Endless*."

Doug: "Cyclic, so you're never coming to the end?"

Ralph: "Right, that's what the music is also like. We have to start the concert at 8:00 and we have to stop sometime because the halls are rented for a certain time but the music goes on in your mind before and after you play. It's really just an agreement you make to stop at a certain time. On record, it goes for 40 minutes because an album has these dimensions. It's just an agreement. But really the music goes on. That's what we want to do to open up people's ears to everyday sounds so that they can find more music and are not so much dependent on just three-minute records."

Doug: "I can't help but think of

John Cage."

Ralph: "Yes."

Doug: "One thing he tries to get across is that we don't have to be organizers in order to have music; that music exists without us. We only need to be open and listen."

Ralph: "We call it Tape Consciousness."

Doug: "What is Tape Consciousness?"

Ralph: "Your mind is like a blank tape, and so whatever comes in is recorded."

Bryce: "Who invented this phrase?"

Ralph: "It just came. This is possible since the '40's when magnetic tape was introduced in Germany. So this is not just an object but it effects your mind. It's not just outside on tape but it is also here (pointing to himself). You know when you push the red button, that you live in a different situation."

Doug: "Do you find people like John Cage, Stockhausen, and Leggetti to be influences on your thinking?"

Ralph: "Yes, because they had official status and we were the next generation we would hear their music on the radio. It was very natural. It seems in America on one hand, things are very advanced with all this technology but on the other hand . . ."

Florian: "The hardware in America is very advanced but the software is very often antique."

Ralph: "You have modern TV systems and then you put on a cowboy show. It should be that the program is adequate to the technology of the apparatus. That's what we try to do. If we succeed I don't know."

Bryce: "All of Europe isn't like that I'm sure. It seems their as susceptible to the entertainment factor as we are."

Ralph: "Oh sure, I can watch *Bonanza* if I have nothing else to do. I feel ways there are so many things that we should do and have to do that I don't take the time. But there is a very large portion of people that are lazy and they take whatever is on television for given. Once you realize how it's done and what it really means, you come even to the point that you cannot watch it because you get physically sick. It makes me sick."

Florian: "I can't stand American TV."

Ralph: "We never watch TV here

or very rarely. It conditions your mind. You do not talk to everybody in the street so why should I listen to everybody on television just because he's on television, it doesn't mean he has anything to say. Just the status of being in the medium does not mean the information has any more value. I'd rather listen to a friend who I meet and who might not be on television that has something to say to me."

Bryce: "What kind of response did you get in America?"

Ralph: "We have had a very positive reaction to our music because I think in America there is also this consciousness that people want something different, new, instead of something routine."

Bryce: "Most of your music is black and white keyboard oriented. Other composers are into a more esoteric music where the black and white keyboard is almost taboo, they're into touch sensitive, modulation, skin response and alpha waves."

Ralph: "This for us is also a realistic problem. In order to record alpha waves we have to have some academic status to be able to get the necessary equipment and we do not really go for academic status. We were lucky to get in touch with these things and expose ourselves to such news."

Doug: "We were talking before about the symbiosis between the environment we can technologically create for ourselves and what we are as people and how they affect each other and form a symbiosis. How do you see computers entering into this? Do they interest you for your performances?"

Ralph: "Yes, we use a lot of computer components although we don't have a big computer system, but we use computer storage like a sequencer."

Doug: "How have you evolved from *Radio Activity* to *Europe Endless*? What has changed, what's new?"

Ralph: "It's hard to say, we do not have the distance to talk freely about it. It's still very, very close. As far as I can say, now, it's dealing more with this psychological aspect we were talking about whereas some of our former albums were dealing with certain outside things like *Autobahn*. On there we

continued on page 26

More: Kraftwerk
from page 25

have this story of our music being played over the car radio while we are sitting in the car and driving. This is what actually happened while we were in America. We were driving from the airport to the hotel and turned on the radio and our music was coming out. The composition was about this and it is reality for us.

Doug: "And it's cyclic. It comes out of the radio, goes into you and onto your next record."

Ralph: "Yes, we just have to stop because it is a record. The new album is more self-reflective of our cultural standpoints."

Bryce: "Are you involving as much if not more vocal material on Europe Endless as you have in the past?"

Ralph: "Yes, but for nine years we were afraid to put our voice on tape."

Bryce: "Why is that?"

Ralph: "I don't know, it's some kind of . . ."

Florian: "Paranoia."

Ralph: "Tape paranoia."

Doug: "And yet, it's such a way to achieve that symbiosis."

Ralph: "Yes, once we were able to put these voices out and find a positive reaction it has happened more and more. Now we have . . . I shall not say overcome, that is not right but we have . . ."

Bryce: "You don't feel as paranoid."

Ralph: "Yes we do, but we can handle it. Because it is still there, it would be wrong to deny our tape paranoia as you have noticed with something in America called "Watergate Tapes." This is also tape consciousness. It is present in all parts of everyday life. I don't know if in America tapes are legal if somebody records you. How about what we had to say to you so that you could print this. So it would be wrong to deny tape paranoia. It would be a lie. We can work with this in such a way as to help us . . . our existence. It discovers things within ourselves we wouldn't have known before."

Bryce: "On your pre-Autobahn album there were acoustic instruments pictured on the cover. Do you plan to utilize acoustic instruments in the future?"

Ralph: "We are totally electronic apart from voice. It's just that the means for producing our ideas is ideal

in electronics. When we have something we want to say on a violin, we will then use a violin to say it, but rather what we want to say in the last two or three years was purely through electronic mediums."

Doug: "Is there a special way you use voices? Is it semantic or used for its sound value?"

Ralph: "For both. We always compose what we call sound poetry where the words are chosen, or come out of a special sound pattern so that even if we sing in German, which we did on *Autobahn*, we were understood in America and in Japan because the words sound like what they mean, although they may have a more semantic or logical meaning. Most of our lyrics we compose out of sound, also some of the lyrics are composed strictly for meaning, then they also are spoken. We use the voice in all different aspects."

Florian: "Vocal painting . . ."

Doug: "Have you done any works using vocal sounds as the only sound source?"

Florian: "Not yet, but we think about that."

Ralph: "We also make most of the music out of singing so we make the oscillator sing and breathe. It's not that all the things are purely mechanical or very detached, but some of our compositions are like airwaves so the airwaves sing."

Doug: "That seems like a continuation of the symbiosis concept where the technology and the human being become . . ."

Rolf: "One."

Doug: "We were talking earlier about the power of the entertainment media. Popular music seems to be one of the largest manifestations of that idea in this country. Kraftwerk is able to exist on that level too. How do you see yourselves in relation to popular music? Would you consider your music as being a popular music or do you see it any way contradictory to the medium?"

Ralph: "No, it just happened to be popular."

Doug: "It wasn't your intent to make it popular?"

Ralph: "We just want to speak to other people with our music but we can't force anyone to like it or not like it."

Florian: "When you've found something you think is true, you try to make it popular."

Ralph: "We consider ourselves not so much entertainers as scientists. The idea of the scientist or mad scientist finding something that is true within its definition. We work in our studio/laboratories and we find something, we put it on a tape, it is there and we present it. We find that many people like the way we work."

Doug: "In my thinking I would say that Kraftwerk is an ensemble and that seems to be part of your musical intent. Yours is not a synthesis trying to create orchestral grandeur, but a group of four, an ensemble. What do you think about Tomita, Larry Fast (Synergy), and Walter Carlos who are trying to do an orchestral electronic music, where they do not relate as a performer but mostly as a master controller. What is your feeling about that sort of usage of electronic music?"

Ralph: "Very good, but it's like you said, a master controller and they do not write about any experience they just adapt the technology to something. I think Walter Carlos only wrote music on one album about the seasons and I think on all the other records he only adapted the music to the technology. You can just listen to the record at home, but when we play the music comes out different, it's like we take the risk . . . We have one piece called "Electric Roulette" because our electronic equipment is very breakable. From time to time, after a series of concerts something breaks. We have to take these risks. The records you were talking about do not take that risk, they just stay in the studio behind closed doors and release a finished tape."

Doug: "It doesn't seem to work towards symbiosis."

Ralph: "No, we go there and stand in front of other people and we make up the music. I think that's why our music has also found good reaction. People like to see people doing something, not just pretending. If we play a tape, we play a tape, and we show that we play a tape. Most conventional entertainment is just playing a tape but people pretend to be very live, they shout and sweat but if you come to the essence of it, it's just a tape that's being produced. We we play a tape, we play a tape, we do not sweat and when we

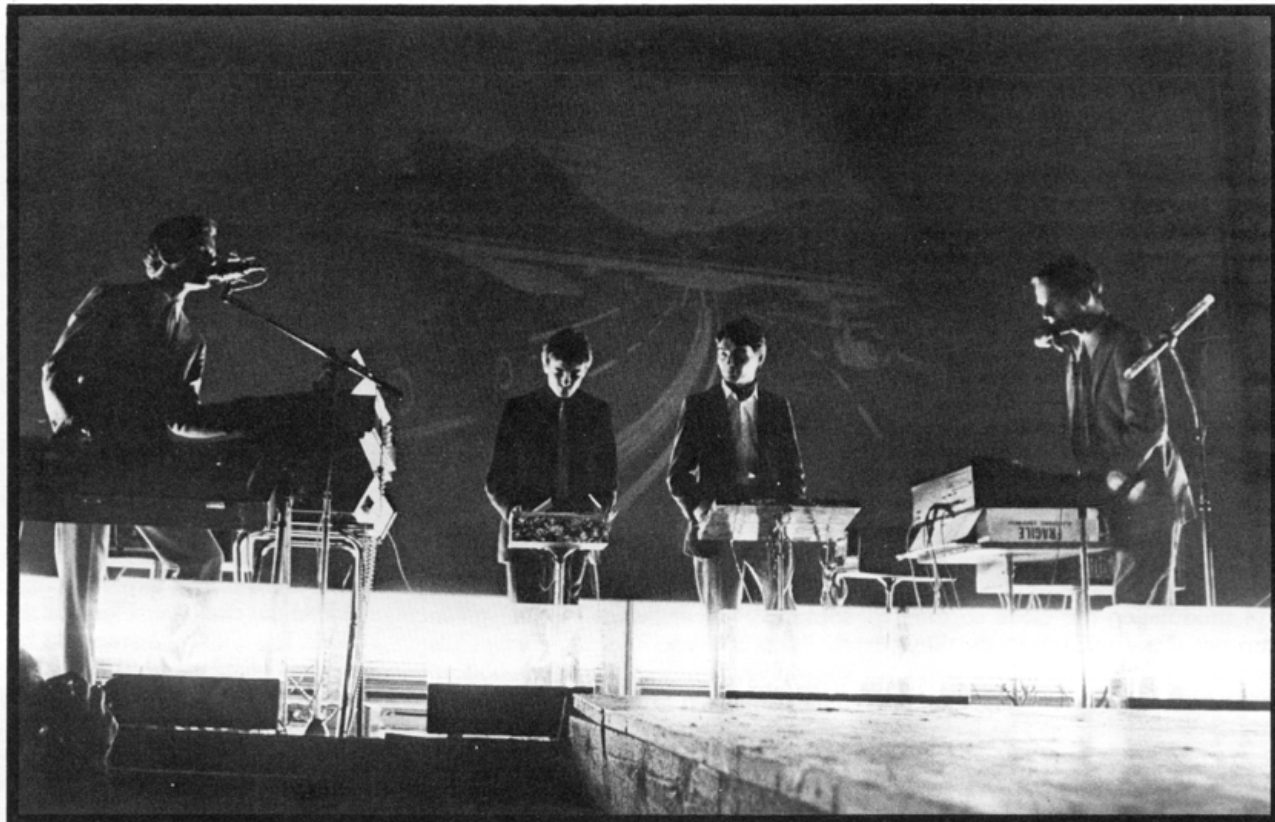

“We were driving from the airport to the hotel and turned on the radio and our music was coming out.”

play music or make up music then we make up music and show what we do.”

Bryce: *“What was the thing that involved you with electronic technology to begin with?”*

Ralph: *“Tape consciousness.”*

Florian: *“The limitations of traditional instruments.”*

Ralph: *“What happens when you turn on the tape is the basic question.”*

Bryce: *Are many composers in Europe approaching music in other than a black and white keyboard approach?*

Ralph: *“Most electronic musicians are afraid of tonality. When you see the world of frequencies there is tonality, you cannot deny it. The dictatorship of tonality or the dictatorship of non-tonality, is the same.”*

Florian: *“The outer musical world.”*

Ralph: *“So when we feel harmony we play harmony, when we feel disharmony, or free tonality or openness*

we play open. It makes no difference, it’s the range of frequencies.”

Bryce: *“What did you mean by ‘the outer musical world?’”*

Florian: *“It’s what happens on the street. It’s all you hear. I hear a lot of cars playing symphonies.”*

Ralph: *“They play in harmonics, they play free harmonics. Even engines are tuned.”*

Florian: *“The 60 hertz tone from the AC outlet.”*

Doug: *“And these lights.”*

Bryce: *“The air conditioner.”*

Doug: *“Are there any instruments you would like to see that are not in existence so far?”*

Ralph: *“One where you can instantly hear what you think.”*

Bryce: *“So immediate transfer from thought process to sonic process.”*

Ralph: *“Without time delay, like thinking of something, writing it down and going the next day to the studio to spend hours and hours to produce*

something.”

Bryce: *“Do you think it can be developed at this time?”*

Ralph: *“Yes, it happens between us.”*

Florian: *“We’ve worked together for eight or nine years and sometimes it takes just one word and I know what he means. Sometimes you see people and you know what they play, you know what they sound like.”*

Bryce: *“So you feel that art and music will be transmitted telepathically in the future?”*

Florian: *“Definitely.”*

Ralph: *“What else is there to do?”*

Florian: *“Think about Rosemary Brown.”*

Bryce: *“Who’s Rosemary Brown?”*

Florian: *“She is a medium living in England.”*

Ralph: *“She receives visits from classical composers.”*

Florian: *“She writes in this way.”*

More: Oberheim from page 15

have several oscillators, and then you end up with one filter and only one VCA. Everything has to go through the VCA. You can make it happen with really one note in essence. So that's the ultimate monophonic instrument; a one voice synthesizer.

"The ultimate at the other end is when you've got a synthesizer voice for every key, so that there can be no confusion as to where the key goes. In terms of reducing this confusion, of what happens if you've got a synthesizer for each key; that you have no question when you play a certain key that goes to a synthesizer. That's essential to the Polymoog; that's the approach they take. They developed oscillatory signals with organ technology using organ top octave generators and dividers. They take digital signals and they get sawtooth waves. They've got ways of modulating the clock so that you can get vibrato. Each of the key signals goes through an integrated circuit that has a simple VCF, VCA, and two envelope generators. The filter is simple; it's not a fancy voltage control twenty-four db with resonance like you normally find. It's a somewhat simpler filter. In their system, there's no question if you play middle C where it goes: it goes to its own chip. There's a chip on each note; so there's 72 or 76 integrated circuits. Each one has a filter and an envelope generator. In between is where we get into what Oberheim is making. You've got a situation where you have a multitude of keys but you don't have as many synthesizer voices. Obviously, if you're going to have a polyphonic instrument, you've got to have more than one synthesizer voice. When I talk about a synthesizer voice; a 2600 is a single voice, a Minimoog is a single voice, and an expander module is a single voice. That's a monophonic situation even though you've got more than one oscillator, you still have one VCA."

Synapse: "Isn't the 2600 now two-voiced?"

Oberheim: "It's got the ability to play two pitches, but it's still only got one filter, and only one VCA. You can play two notes on a 2600 and hear two pitches, but only one of these notes can control the VCA."

Synapse: "And they'll both be processed the same way?"

Oberheim: "Yes, one or the other or the summation of the two will

control the VCA, so they're not independent voices from a musical sense. It's like saying: you sing tenor, and I'll sing baritone, but you can only sing when I sing, well that's not true contrapuntal music. So the 2600, because of its single VCA, and single filter, is a one-voice synthesizer. What we do is: we have a bunch of expander modules which give us the one voice, you still have the problem where you have only a given number of voices but you've got a lot of keys. You have to have some sort of assignment; algorithm is the word.

"It's a process of rules to accomplish a task. Computer programmers use algorithms to solve problems. In this case, it's a fancy word for what rules you follow to assign the depression of a key to a given voice.

"In a four-voice system, it would be nice if always the top note (the soprano voice) went to a given module so you could control its soprano-type timbre; and if the bottom note went to a given module so you could control its bass-type timbre, and if the alto and tenor voices went to their respective modules. The only system for this that seems to make sense, is one where you've got to assign the voices according to the time in which they're played. The most important rule that we can make is that, once your finger depresses a key, it gets assigned to that voice and that assignment is fixed; you can't destroy it without lifting your finger. I'm sure that as polyphonic systems advance, there will be rules that are more sophisticated with the influx of micro-processors, there will be flexibility given to the keyboard. If you're going to build a thick system out of so-called "hard wire logic," I think that the time assignment method is the one that makes the most sense.

"I'm sure that time will advance whatever algorithms we use. It's conceivable that you could have a voltage-controlled synthesizer some day for every key. But what if you wanted the ability to make each voice different? Can you imagine having seventy-two voices? Because I think in terms of expander modules, imagine having 72 modules there, or 37 modules, or even 30? There are synthesizers with 30-note keyboards; 30 expander modules? Whew! I mean you couldn't, it's impossible!"

Synapse: "What relation did the polyphonic scanning keyboard have to

the development of your system?"

Oberheim: "The thing that put us into polyphonic synthesizers was more than the development of the keyboard; which is crucial. However, the thing that really allowed us to relatively painlessly go into the polyphonic business was more the development of expander modules. The keyboard was crucial, but the polyphonic scanning keyboard has been built before. They are not new. ARP and Moog, I'm sure, sometime in their deep dark past have used them. If you build a polyphonic keyboard — something that puts out a multitude of control voltages and gate combinations, you end up having to run each one through a complete synthesizer, or a bunch of modular components. That gets expensive, bulky, inconvenient and very unwieldy. With the expander modules, you've got the basic element that you need. The expander module by itself, makes a nice little synthesizer. We conceived of that originally, we built our machines around that. By the time the expanders were well along in development, it occurred that this was perfect for a polyphonic synthesizer. The success of the unit at the moment, is because of the fact that the expander module is just the right product for doing that. I'm surprised at how nicely it turned out. That's the one I'm most proud of, and that's the instrument that I personally enjoy playing the most."

Synapse: "When electronic music first started, it was a very mysterious thing. Some people like the mystery, and want to hold onto it. Some people want to get away from it; like ARP with a synthesizer in every house or whatever. How do you feel about this mystique?"

Oberheim: "I think that there are at least two divergent areas of electronic music. The dividing line between these two, I feel to a large extent, is Buchla and Moog. I'm talking both historically, and contemporarily. I was at UCLA at that time, in 1961 and it was just starting to be done in universities. You couldn't really go out and buy a synthesizer at a store, but you might have heard about them. Chances are, all you'd have heard about was the tape music. There is the electronic music thing that grew up essentially in the classical music area, the musique concrete and its extensions, and tape music of various kinds. That was

expanded and refined and then Don Buchla came along and had exponents like Subotnick. Someone like Subotnick is the product of the classical music world. Certainly he's not a pop musician. Bob Moog and Buchla were doing their thing at roughly the same time, from what I understand. But the Moog thing, for whatever reason, Walter Carlos notwithstanding, first stimulated a completely different area of the musical world. When synthesizers first started to be used by pop musicians, they always started using Moog synthesizers. Walter Carlos gave it its impetus.

"So there are these two areas and I think, when you talk about the mystery of electronic music, I would consider that more in the classical area."

Synapse: "So you think that the mystique lies in the Avant-Garde?"

Oberheim: "Yes, I don't think there is too much mystery left in the area of synthesizers."

Synapse: "When synthesizer music started, say in Rock, people would listen to it and say: 'Wow! What's that sound?' That sound was undefinable. Nowadays, everybody says: 'Oh! of course, it's a synthesizer.' It's like an expressive thing right now. Do you think when everything is synthesized, that people will get bored of it because we don't have that different sound to jump into?"

Oberheim: "Well, I don't see people becoming bored of synthesizers."

Synapse: "I'm speaking specifically about the polyphonic sound. Where everything is synthesized and you don't have that completely different sound."

Oberheim: "What happens with polyphonic synthesizers, I'm finding, is that you've regenerated the synthesizer fame. You've generated a whole new set of sounds. I don't think that the monophonic has reached its peak yet by any means. We think of synthesizers as reaching some high state of development when they've already been around now for 10 or 11 years. People are just now learning to use them. I build synthesizers because it is such a fun thing to do. I'm not convinced that they are going to take over the world by any means. I enjoy it from a technological sense combined with the gratification of seeing something that I build being used in a musical sense by a musician."

Cerwin-Vega

GRAPHIC EQUALIZER

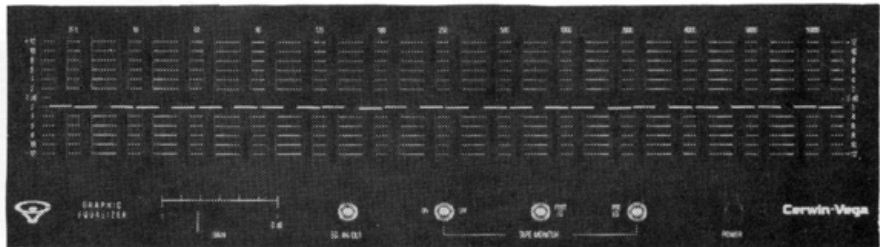

- 13 frequency bands covering entire audio spectrum
- "Active Gyrotor" circuitry — no inductors to distort or pick up hum
- Tape monitor circuit — pre or post equalizer
- Built in subsonic filter and turnon delay circuits
- Wide input and output overload margins
- Rugged, rack-mountable steel chassis with plug-in circuitry

Write for more information on the GE-2 and Cerwin-Vega power amplifiers, mixers, and speaker systems.
6945 Tujunga Avenue/North Hollywood/California 91605



Ultra stable oscillator with foot selectable preset frequencies • automatic squelch inputs for optional pressure sensors (pedals) controlling the amount of modulation (0-100%) and/or glisses of the modulating frequency • long 9v. battery life.

Cost: \$150.00 C.O.D. only, Calif. residents please add sales tax. Pressure Sensors are \$32.00 each.
SYNERGY ASSOCIATES
1107½ N. Western Ave.
Hollywood, Calif. 90029

More: Analog Shift Register
from page 19

age). Use of an etched PC board is the easiest manner to achieve this guard band. Note: substitution of

components in this circuit will not work!

The ASR is available in a semi-kit form consisting of a completely built and factory-tested PC card with panel

graphics and hardware for \$88.00 from Serge Modular Music Systems, 1107½ N. Western Ave., Hollywood, Calif. 90029. California residents must add 6 percent sales tax.

Figure 6.

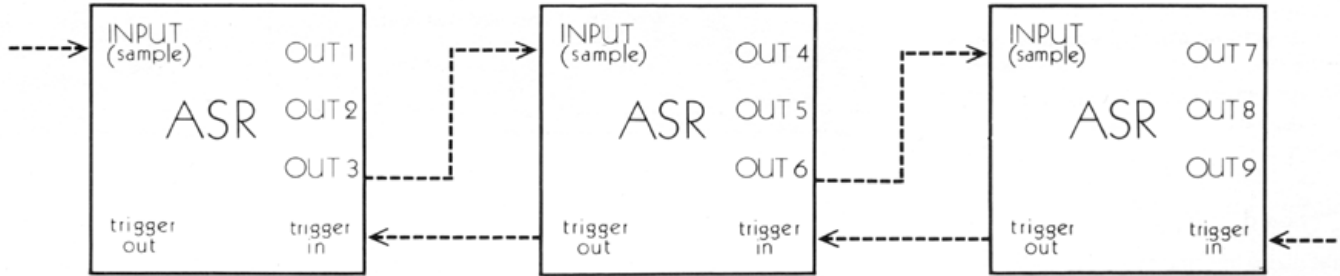
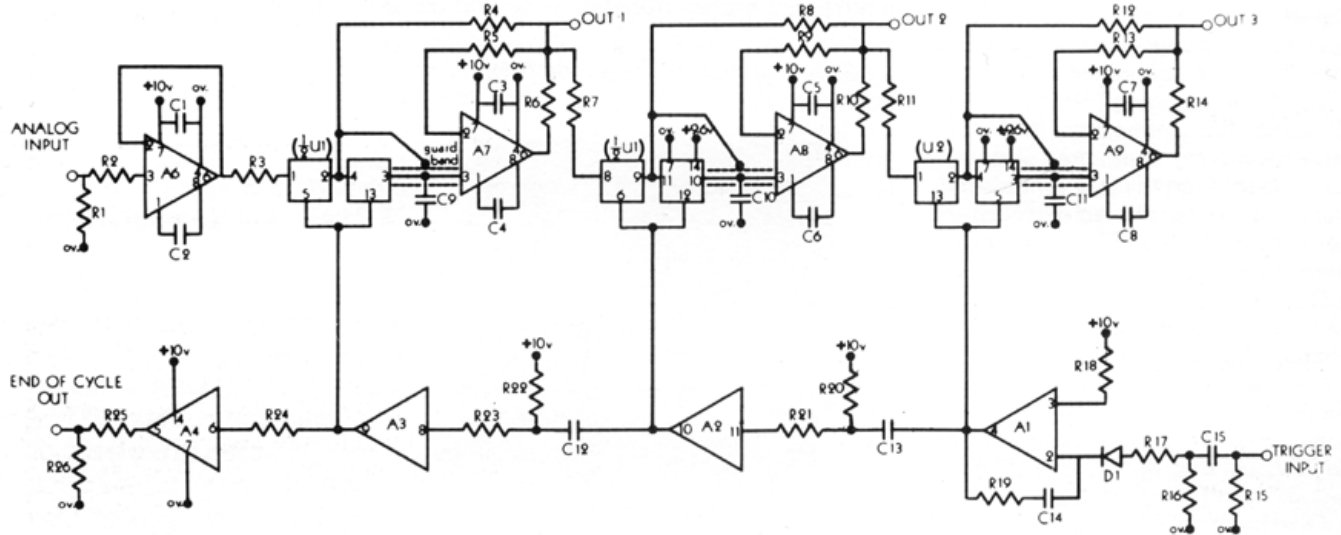

Figure 7: Circuit diagram for the Serge Analog Shift Register.



Analog Shift Register = PC1075SR = Serge Modular Nov. 75

R1, 15, 16, 17, 24	68k
R2, 4, 5, 8, 9, 12, 13	33k
R21, 23, 25, 26, 27	10k
R18	680k
R19, 20, 22	330k
R3, 6, 7, 10, 11, 14	3.3k
D1-5	1N914
A1-4	LM3900n
A5, 6, 7, 8	CA3140
U1, U2	CD4066
C1, 3, 5, 7, 12, 13, 15	.01mF ceramic
C2, 4, 6, 8, 14	.001mF ceramic
C9, 10, 11	10,000pF polystyrene

Note: replace d2-4 with one 4.7 V zener for circuit operation on a 15V power supply.

Diagrams: A. Schill

More: Gnome
from page 21

6. Run a piece of bare wire between all the top pins on the dip switch and attach the end to the bottom lug of the pot. Run short pieces of wire between the outputs (switch 1-7 on p.c. board) and the corresponding pins of the dip switch (Fig. 4).
7. Using a piece of thin cardboard or foam to insulate the back of the board from the Gnome chassis, install the assembly. Mount the pot; then using epoxy or rtv, mount the dip switch.

Complete by attaching +9, VCA, ground, and VCO leads to the Gnome. The VCO connection to the circuit board is shown in the photo (Fig. 5).

Parts List:

- CD 4024
- 7SPST dip switch
- 1 100 mfd 10v radial
- 1 5 mfd 10v axial
- 1 56 ohn 1/4 watt
- 1 150 K 1/4 watt
- 1 miniature 10 k pot
- knob, wire

A kit of parts including p.c. board and wire is available for \$10.40, California residents add 6 percent sales tax, from:

John Blacet
4019 Chico Avenue
Santa Rosa, California 95401

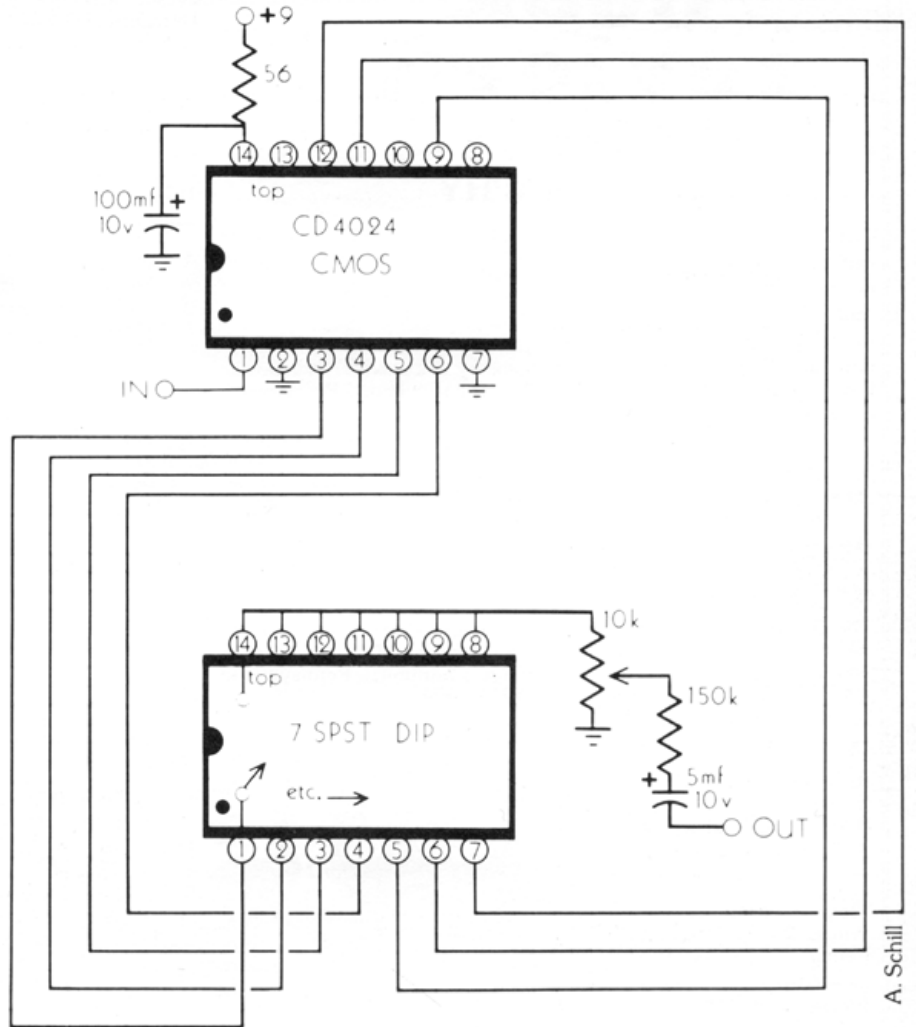

Figure 4.

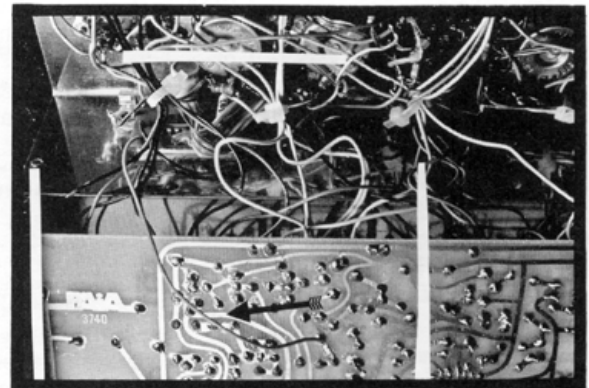

Figure 5:
VCO connection.

More: Reviews
from page 23

Electronic Music, for its style and organization is that of the 20th century Pop music.

On the other hand, for those with an Electronic Music background, it would be of interest because it is well executed and unique.

Of special interest are two works, "Classical Gas" by Mason Williams

and "Largo" from "The New World Symphony," which Larry Fast has realized. If the reader is familiar with any of the works of Tomita or Walter Carlos, he will find Fast's style much different and more viable. Fast does not use the same orchestra.

The cut which I would especially recommend, is the last one on the album entitled "Sequencer." It is an example of what Fast might have done

with the other works. The color and dynamics were diverse and changed frequently in "Sequencer." The lack of change in color and dynamics was the only thing I found lacking in the other cuts on the album. I would definitely recommend this album and also Fast's first album, *Synergy*. He has created his own style; he is a good composer, and I am sure we will hear much more from him.

- Stan Levine

book reviews

ELECTRONIC MUSIC BIBLIOGRAPHY

This column will feature reviews of newly released books on electronic music and related topics. However, in order to provide the reader with a broader view of existing literature, we have compiled this bibliography. Ed.

Guide by E. Schwartz. Praeger Publishers. 111 Fourth Avenue, New York, N.Y. 10003. 1973

Electronic Music Circuit Guidebook by Brice Ward. Tab Books. Blue Ridge Summit, Pennsylvania 17214. 1975

Electronic Music for Young People by F. William. Center for Applied Research in Education, 521 Fifth Avenue, New York, N.Y. 10017. 1974

Electronic Music Production by Alan Douglas. Tab Books. Blue Ridge Summit, Pennsylvania 17214. 1974

Electronic Music Synthesis by Hubert Howe, Jr. W.W. Norton and Co. New York, N.Y. 1975

Electronic Projects for Musicians by Craig Anderton. Guitar Player Productions, P.O. Box 615, Saratoga, California 95070

An Electronic Studio Manual by

Ronald Pellegrino. Ohio State University College of the Arts, Hitchcock Hall, 2070 Neil Avenue, Columbus, Ohio 43210. 1968

Experimental Music by Michael Nyman. Schirmer Books, division of Macmillan Publishing Co. 866 Third Avenue, New York, N.Y. 10022. 1974

A Guide to Musical Acoustics by H. Lowery. Dover Publications, 180 Varick Street, New York, N.Y. 1956

International Electronic Music Catalog by Hugh Davies, Editor. M.I.T. Press, 28 Carleton Street, Cambridge, Massachusetts 02142. 1968

Introduction to the Physics and Psychophysics of Music by Juan G. Roederer. Springer Verlag, 125 5th Avenue, New York, N.Y. 10010. 1973

Learning Music With Synthesizers by David Friend, Alan R. Pearlman and Thomas D. Piggot. Hal Leonard Publishing Corp. 320 Needham Street, Newton, Massachusetts 02164. 1974

The Liberation of Sound by Herbert Russcol. Prentice Hall, Inc. Box 500, Englewood Cliffs, New Jersey 07632. 1972

The Modern Composer and His World by John Beckwith and Udo

Kasemts, Editors. University of Toronto Press. 33 East Tupper Street, Buffalo, N.Y. 14208. 1961

Music, Physics and Engineering by Harry F. Olson. Dover Publications. 180 Varick Street, New York, N.Y. 1966

Music, Sound, and Sensation by Fritz Winkel. Dover Publications. 180 Varick Street, New York, N.Y. 1967

The New World of Electronic Music by Walter Sear. Alfred Publishing Co. 75 Channel Drive, Port Washington, N.Y. 11050. 1973

Principles and Practice of Electronic Music by Gilbert Trythall. Grosset and Dunlap, Inc. 51 Madison Avenue, New York, N.Y. 10010. 1975

Synthesizer Primer. Electronic Music Laboratories, Inc. P.O. Box H, Vernon, Connecticut 06066

The Technique of Electronic Music by Thomas Wells and Eric Vogel. University Stores, Inc. P.O. Box 7756, Austin, Texas 78712. 1974

The World of Sound (for use in elementary and junior high schools) by Sir William Bragg. Dover Publications. 180 Varrick Street, New York, N.Y.

The Acoustical Foundations of Music by John Backus. W.W. Norton and Company, Inc. 500 Fifth Avenue, New York, N.Y. 10036. 1969

The Development and Practice of Electronic Music by Jon Appleton and Ronald Peresa. Prentice Hall, Inc. P.O. Box 500, Englewood Cliffs, New Jersey 07632. 1965

A Dictionary of Electronics by Samuel Handel, Editor. Penguin Books, Inc. 72 Fifth Avenue, New York, N.Y. 10011. 1971

Electronic Music by Allen Strange. Wm. C. Brown Publishing Co. 2460 Kerper Blvd., Dubuque, Iowa. 1972

Electronic Music — A Listener's

classified ads

20 words/\$1.00

SYNAPSE

P.O. Box 359

N. Hollywood,

Ca. 91603

Electronic Music Schools and Programs

Please send us a description of your courses, services, philosophies, and equipment status to Synapse. Be part of our Electronic Music Education listing.

SYNAPSE
P.O. Box 359
North Hollywood, Calif. 91603

WANTED: Ads for this classified section, under the headings of:

Services Job Offers
For Sale Jobs Wanted
For Rent

Composers and Performers

Let us know who you are and what it is that you are doing out there with electronic music. We are compiling a reference file on all electronic music composers and performers. We need your help to be complete. Send all information to:

SYNAPSE
P.O. Box 359
North Hollywood, Calif. 91603



Con Tempo

Music Guild

ELECTRONIC MUSIC WORKSHOPS
PRIVATE INSTRUCTION

(213) 784-8271
13273 Ventura Blvd., Suite 104
Studio City, Calif. 91604

(SUBSCRIBER'S FORM)

• PLEASE PRINT CLEARLY •

Name: _____
Address: _____
City _____ State _____ Zip _____

1 year/six issues \$6.00 - in U.S.A. & Canada
1 year/six issues \$7.50 - foreign rate

(SUBSCRIBER'S FORM)

• PLEASE PRINT CLEARLY •

Name: _____
Address: _____
City _____ State _____ Zip _____

1 year/six issues \$6.00 - in U.S.A. & Canada
1 year/six issues \$7.50 - foreign rate

(SUBSCRIBER'S FORM)

• PLEASE PRINT CLEARLY •

Name: _____
Address: _____
City _____ State _____ Zip _____

1 year/six issues \$6.00 - in U.S.A. & Canada
1 year/six issues \$7.50 - foreign rate

**SUBSCRIBE
TO**

Synapse

the
electronic music
magazine

ONE YEAR/SIX ISSUES = \$6.00 U.S.A. & Canada
to: SYNAPSE MAGAZINE/Subscription Department

P.O. Box 359
North Hollywood, California 91603



— make checks payable to SYNAPSE MAGAZINE



THIRD CLASS MAIL



Synapse

the
electronic
music
magazine

