

CIDALIA

VOLUME 1 NUMBER 5

JANUARY-FEBRUARY 1977/\$1.25

THE ELECTRONIC MUSIC MAGAZINE

# Synapse

Gary Wright  
Page 17

---

INTERVIEW:

**Patrick  
Gleeson**

---

---

N.Y.C.:

**Liz  
Philips**

---

---

MORE

**Guerilla  
Electronics**

---



## THE ULTIMATE KEYBOARD MACHINE

Pictured here is the most incredible development yet for the multi-keyboard artist. At first glance it's an Oberheim Four-Voice Polyphonic Synthesizer — already accepted as the best money can buy.

What's new is the Polyphonic Synthesizer Programmer. It's a memory device that stores patches of your own creative design and allows you to recall any of them at the push of a button. And you're still not locked in because they're all completely variable at your discretion.

Complaints about the inability to patch quickly while on stage or in the studio, the creative barriers of pre-set instruments, and the burden of carrying six or more keyboards are now over.

The problem for most keyboard players isn't getting enough instruments to create on. It's getting one totally versatile instrument to create with.

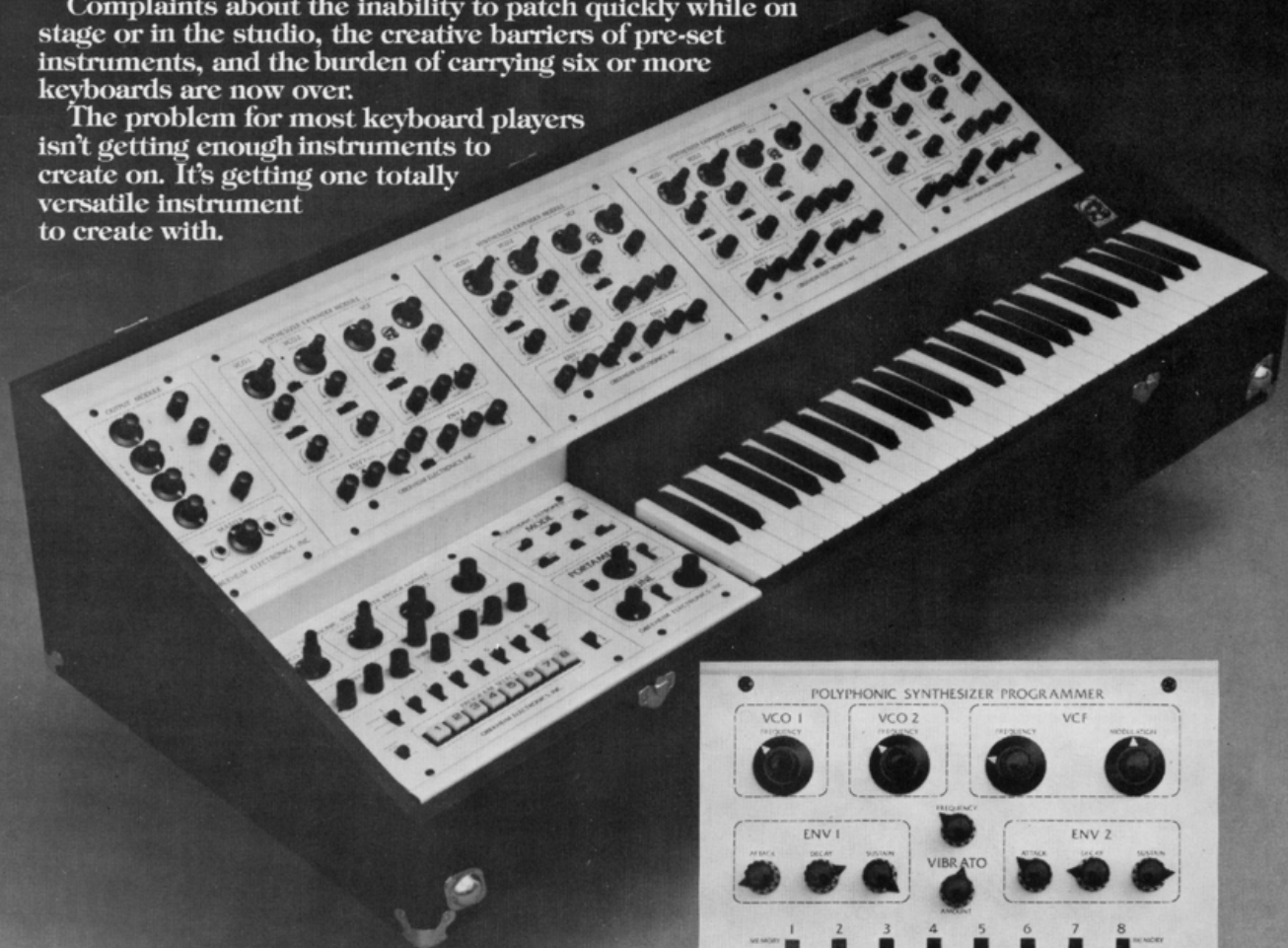

# Oberheim

Some Things Are Better Than Others

Oberheim Electronics, Inc., Dept. B  
1549 9th St., Santa Monica, CA 90401

Volume 1 Number 5

Editors

Angela Schill, Douglas Lynner

Design and Production

Chris August

Photography

Bill Matthias

Correspondents

Northern California: Phil Loarie

Connecticut: Chuck Scribner

Maryland: Paul Medlock

New York: Randy Cohen

Contributors

Craig Anderton, Arpad Benares,

John Blacet, Alex Cima,

Randy Cohen, Tom Davey,

Bob Davis, Sue Denim, Rich Gold/..

Peter Hillen, Jeff Janning,

Prentiss Knowlton, Mary Lucier,

Virginia Quesada, Danny Sofer

Carolyn Mittman

NOTE:

SYNAPSE has moved to 2829 Hyans St., Los Angeles, California 90026. (213) 383-7933

SYNAPSE MAGAZINE is published bi-monthly by Synapse Publishing Co., 2829 Hyans St., Los Angeles, Cal. 90026. (213) 383-7933. No part of this magazine may be reproduced, either mechanically or by other means, without the written permission of the publisher. Copyright 1977 by Synapse Publishing Co. Printed in the United States of America.

SUBSCRIPTIONS: U.S. and Canada \$6.00 for six issues, foreign subscriptions \$7.50 for six issues. Single copy newsstand price is \$1.25.

MANUSCRIPTS: We cannot be responsible for the return of any unsolicited manuscripts, photographs, artwork or scores. All contributions are welcome and should be addressed to: SYNAPSE MAGAZINE, 2829 Hyans St., Los Angeles, Cal. 90026.

CHANGE OF ADDRESS: Notify SYNAPSE MAGAZINE/SUBSCRIPTION DEPARTMENT, 2829 Hyans St., Los Angeles, Cal. 90026. Please send both the old and new addresses, and if possible, the mailing label from a copy of SYNAPSE.

# THE ELECTRONIC MUSIC MAGAZINE Synapse

JANUARY-FEBRUARY 1977

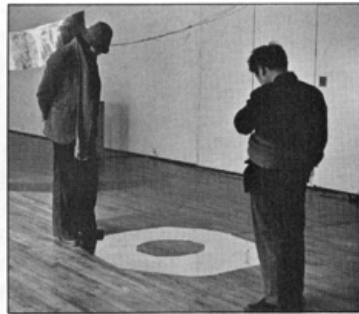

page 14



page 17



page 21



page 26

What To Do Until The 4-Track Arrives  
Craig Anderton ..... 8

Computer Meets Keyboard  
or "Look Ma, No Hands"  
Prentiss Knowlton ..... 10

Walking Ring Sequencer  
John Blacet ..... 13

Liz Philips — New York  
Sound Articulates Space  
Randy Cohen ..... 14

Gary Wright — Interview  
Doug Lynner ..... 17

Pop Goes The Synthesizer  
Jeff Janning ..... 20

Interview With Patrick Gleeson  
Danny Sofer and Doug Lynner ..... 21

A Touch Responsive Keyboard  
Arpad Benares ..... 25

Guerilla Electronics — Part Two  
... Monkey Business Continues  
Bob Davis ..... 26

## DEPARTMENTS

Letters ..... 2

Editors' Note ..... 2

What's Happening ..... 3

Computers ..... 4

Composer/Performer ..... 5

Performance ..... 6

Listings ..... 12

Discola ..... 30

Equipment Review ..... 33

Classifieds ..... 36

# LETTERS

## Guts

Thank you for sending the latest issue of *Synapse*. Earlier, I had come across one of the first issues of your magazine and to be truthful, I was not overly impressed. After reading your November/December issue, however, I can see that a great deal of evolution has taken place.

I read the entire magazine from cover to cover and found something of interest in every section. The interviews were especially well done. Many magazines that deal totally or partly with electronic music seem to be concerned only with the equipment an artist uses and how he hooks it up. After reading your articles on Bob Easton, Malcom Cecil, and Sound Arts, however, I have a good idea of where they are at philosophically and what they're trying to accomplish.

I also appreciate the way you go about reviewing equipment. It's good to explore the negative as well as the positive aspects of a new piece of hardware without being concerned about losing potential advertisers. It takes guts to say the Polymoog "does not possess the vivid 'fat' sound of the Oberheim or even Moog's own monophonic Minimoog" and to refer to the \$4500 price tag as being "stiff." An objective evaluation of equipment is refreshing compared to the glowing comments extracted from manufacturers' brochures that most other

magazines feed their readers.

Although it's overused, the old cliché "keep up the good work" best expresses my sentiments.

Lee Blaske  
St. Cloud, Minnesota

## Tangerine Dream Defended

Just incidentally I came across a copy of your magazine. How ecstatic I was to see someone actually treating a synthesizer as an instrument

of superb capabilities. The insights into the equipment are truly awesome and helpful. However this doesn't preclude that all that glitters is gold. Mr. Richard Wadholm's review of Tangerine Dream's "Ricochet" is largely unfair. I wonder if Mr. Wadholm noticed that "Ricochet" as the title suggests has a bit of everything Tangerine Dream has done, with Electronic Meditation, Alpha Centauri, Zeit, Atem, Phaedra, and Rubicon.

I do believe it is highly unfair to compare a leader with a follower, especially one whose sights are humane and loving, (as T.D. demonstrates in the beginning and end of every album). Kraftwerk, Sensations Fix, Agitation Free, are mere copies, granted with lots of influence, as you say "nebulous tape effects of old Pink Floyd." It is indeed amazing that a rock oriented group has to break the ground along with Paul Beaver and Bernard Krause.

Your other review was fair, rather good. It was Atem that I first woke up to and I remember that I hated it at first, and loved it afterwards.

Aside from a common disagreement of opinion, one should never forget Frederic Gulda, KarlHeinz Stockhausen, Karlheinz Housemann, as German musicians that all along have been working with synthesizers in the classical form. This type of work, I fear has influenced most the like of Kraftwerk (not as good as their first material, nowadays), Sensations Fix, Agitation Free all of which are 2nd rate powers. The real strenghts are indeed Tangerine Dream, Tomita, Beaver and Krause, Can, all of which carve a ground of their own, not to mention Pink Floyd, and Amon Duul 2, the two most liberl and intellectual bands on earth.

Pedro August DeSerra  
Santa Barbara, California

## EDITORS' NOTE

As we step forward in this new year of 1977, our second year of publication, we will be bringing you more and more reading and interesting ideas.

On this issue's cover is rock keyboardist Gary Wright, formerly of Spooky Tooth but now quite solidly making a name for himself in the pop synthesis world. "Dreamweaver" has now been followed by "Light of Smiles," his interview is on page 17.

On page 21 is an interview with Patrick Gleeson, EMu synthesist, producer and programmer. Pat talks about the creative process employed in his realization of Holst's "The Planets," re-titled "Beyond the Sun."

Special features of this issue include two

construction projects — a "Walking Ring Sequencer" by John Blacet and Serge Tcherepnin's "Touch Responsive Keyboard" by Arpad Benares.

Two very innovative artists featured here are Liz Phillips and Maggi Payne. Maggie's recent Bay Area concert is reviewed in "Performance."

This leaves you the reader with two interviews, two construction projects, two underground synthesists, and back by overwhelming popular demand — three more electronic guerillas.

This should keep you busy for a while. There is still time to enter the "Synare" Percussion Synthesizer Giveaway, as seen in issue number 4. And "keep those cards and letters coming in."

# WHAT'S HAPPENING

.. The fourth **Explorations in Electronic Media** concert will take place Saturday evening, March 5, 1977 at 8:30 at the Brand Library, 1601 West Mountain Street, Glendale, Cal. 91201, (213) 956-2051. The program will consist of tape works by **Barry Schrader, Peter Grenader, Tom Wells and John Waddell**, and performances by **LEM** with visuals by **James Yurchenco** and **Courtenay Heater**. It is strongly suggested that you arrive early. Admission is FREE.....

.. **Technical Hardware Inc. (THINC)** has released the MMC-1 digital memory system. An integral keyboard/control panel is used to program pitch voltage, control voltage, 7 on-off functions, and both on and off times for each note in a 256-note digital memory. Any section of the memory can be quickly accessed to play back different compositions.....

.. Have you heard about the **Advanced Tools for the Arts, Studio One?** It's a nicely stocked, keyboard performance synthesizer. One interesting feature is that the patch cord jacks are separated from the control

panels allowing easy access to the knobs.....  
 .. **Harvest**, a non-profit New York corporation will soon be opening **PASS - Public Access Synthesizer Studios**. Several of **Electron Farm's** CBS Buchla Synthesizers, an Electro Comp, and a small Serge Modular System will be available for as-cheap-as-possible rental (\$3.00 per hour with block rates available). Some recording and test equipment will also be available. **PASS**, located in downtown Manhattan,

library (contributions invited), various meetings, seminars and classes (slowly developed) and possibly a small concert space. See manufacturing listing!.....  
 .. The recent curious release of two electronic versions of **The Planets**, one by **Patrick Gleeson**, the other by **Isao Tomita**, has greatly disturbed the estate of the late composer Gustav Holst. The Holst estate has countered by blocking the issuance of publishing licenses for the recordings. It appears that they have been successful in

**Records**. Two principals of the project are **Peter Gabriel** (once a member of Genesis) and **Larry Fast** of Synergy. Sources say the opera will depict a performing group that tours from city to city trying to motivate their audience to use the new technology to leave earth and find a fresh environment.....

.. There is still a little time to enter the **Synapse/Star Instruments Synare Percussion Synthesizer Giveaway**. All entries must be postmarked no later than January 31, 1977 and include your name, address and phone number. Don't forget the zip code.....

.. **Mitchell Waite, Henry S. Dakin, Virginia Quesada and Jim Wiseman** are writing a book called **HANDBOOK OF VOLTAGE-CONTROLLED OSCILLATORS**, for Howard Sams and Company. It will be a guide to the design and use of all kinds of voltage-controlled oscillators (VCOs). An important part of this book will be a list of names and addresses of commercial sources for VCOs, books and schematic diagrams, and individual circuit designers who have specialized in VCO design. They are collecting a wide variety of oscillator designs for many different applications, including data conversion, electronic music, and generation of precise waveforms. If you have either a commercial VCO product, or a schematic design that you would like to share with their readers, please write to the authors at 3101 Washington Street, San Francisco, California 94115, 931-2593.



Along with the recent release of two competing productions of Holst's "The Planets" comes international licensing controversy.

funded by the public and Electron Farm, will be directed by **Gregory Kramer** and **Gerald Lindahl**. There's a tape li-

blocking the release of the two albums worldwide with the exception of the United States.....  
 .. **NAAM Magazine** has published its first issue this month. NAAM covers both traditional and contemporary organ technology and practices. It features a stereo sound sheet insert that accompanies the articles as well as construction projects and an electronic music column. NAAM is available from NAAM, Box 2338, Hollydale, California 90280 for an introductory rate of \$18.00 for 12 issues/year.  
 .. A new rock opera is being produced for **Passport**

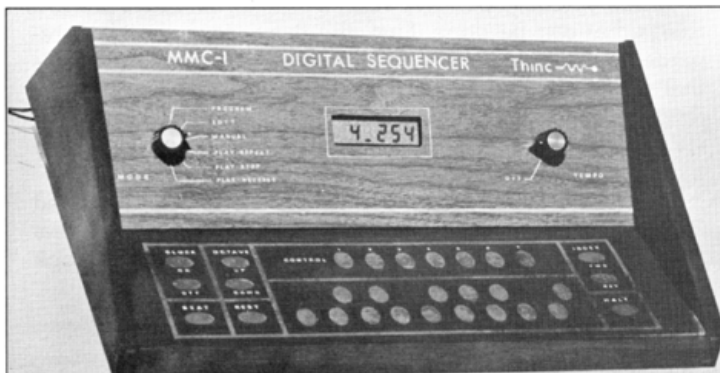

The MMC-1 Digital Sequencer featuring a 256 note memory from Technical Hardware, Inc. (THINC).

# COMPUTERS

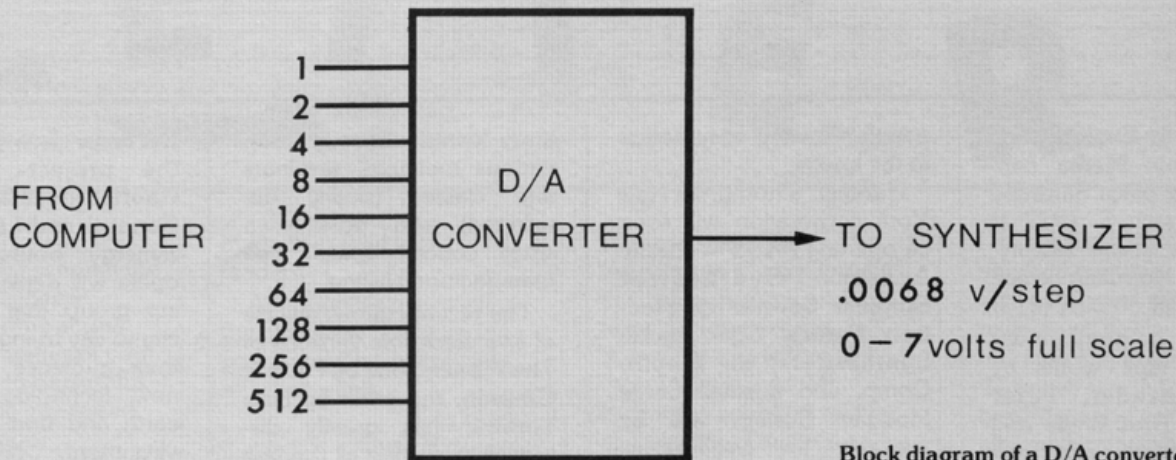

Block diagram of a D/A converter.

ILLUSTRATION BY SUE DENIM

## THE LINK BETWEEN COMPUTERS & SYNTHESIZERS

with PETER HILLEN  
PART I

From last issue's column, we know that a computer represents number values in vastly different ways than from an analog instrument like a synthesizer. Computer number values are stored as binary numbers which are an ordered series of one's and zeros. From the electrical side, this is a series of output lines with some combination of high and low voltages. It is the job of the digital to analog (D/A) converter to take all of the lines which make up a digital number and convert them to a single analog voltage for use by the synthesizer.

Before launching into the mechanics of the conversion two terms need to be defined. The first, FULL SCALE, is the span of output voltage that the converter must provide to the synthesizer. Most synthesizers work on a lv/oct system and have a usable range of about 7 octaves. A converter which can cover the 7 octave range must have a full scale of 7 volts.

The next term is RESOLUTION. A yard stick is good for measuring how tall you are but not the size of a penny, because it does not have enough resolution. Resolution is related to the interval between known points. On the yard stick the resolution is 1/8 of an inch because that is the smallest interval on the stick. In a D/A converter it is the step size of the analog output between two consecutive binary numbers on the input.

These two concepts work together to determine how well a converter can approximate an analog voltage. Let's use them

in an example to further specify the D/A converter that is needed in an Electronic Music System.

The first thing we need to do is determine what is necessary to fool the ear into thinking a control voltage is continuous. This is equivalent to making the converter have more resolution than our ears. Our ears are quite sensitive and we are capable of hearing a variation of just a few cents in the frequency of a tone. A cent is 1/100th of the frequency difference between two frequencies a semitone apart. In a lv/oct. system, the interval between any of the 12 semitones is 1/12 volt (.083v). Let us assume that we cannot hear anything less than a 10 cent change in frequency. That corresponds to a .0083v change in control voltage. Next, we need to find out how many of these steps are in the 7v full scale. It is 7v/.0083v which is 843 steps.

So, to produce a 7 octave "continuous" sweep of frequencies, it is necessary to divide the range up into 843 steps of .0083 each.

The final item to be determined is how big must the binary word be so it can cover these 843 steps. Remember, the digits in a binary word are related by powers of 2 (1, 2, 4, 8, etc.), so each digit which is added doubles the maximum count of the number. A 10 digit binary number has the fewest number of digits, yet is still capable of counting to at least 843. Actually, a 10 digit number can count to 1024 ( $2^{10}$ ). In the figure is shown the binary number and its decimal equivalent.

We only needed 843 steps and we got 1024. There are two things that can be done. First, the extra steps can be disregarded by never counting above the 843. Second and best is that we can compress the 1024 steps into the 7 volt range, thereby making the step size smaller, and the resolution better. By doing this, the step size is .0068v (7v/1024) which is only a variation of 8.2 cents.

Also in the figure is a block diagram of the newly defined D/A converter. Next time we will derive a mathematical formula which will show how the converter works and look into some actual methods of implementing a real one.

$$1024 \text{ STEPS} = \text{////////// (BINARY)} = 2^9 + 2^8 + 2^7 + 2^6 + 2^5 + 2^4 + 2^3 + 2^2 + 2^1 + 2^0$$

Maximum count of a 10 digit binary number.

# COMPOSER/PERFORMER

## PHILIP SPRINGER

by ALEX CIMA

On May 1st, 1976 in the Fine Arts Auditorium at the Wilshire Ebell Theatre Dr. Philip Springer put on a one-man concert as an electronic music composer-performer. Springer operated synthesizers, played piano, and pushed and pulled endless attenuators that evening. He also organized the entire production, including advertising, ticket printing, publicity and the like . . . " . . . spectacular . . . ingenious . . . and, of great poetic sensibility", were among the adjectives *High Fidelity* magazine (November 76) used in describing "The Space Watch Murders" and "American Fantasy," two quad works of the evening.

Springer was commissioned to compose a work for the opening of UCLA's new alumni center. Springer considered the topic of the evening's lecture, the architecture of the building, and the makeup of the audience, and composed "Black Holes." In this work, the hum of the audience before and after the lecture was converted to a voltage which controlled phasing and filtering of four twelve-tone chords which are mixed with the output of an ARP 2600, on which every single module was tied up in a complex real time network; Springer performed three

fantastic space patches and panned them randomly around the building.

Springer is probably the only PhD. who has composed four songs, each of which sold over a million records (for Cliff Richard, Frank Sinatra, Frankie Laine and Eartha Kitt). Far from esconcing him in the "commercial" field, Springer feels that this pop background puts him in touch with the emotional responses of mass audiences. He resides in Pacific Palisades where he divides his time between designing and building modules for his lab, already one of the more advanced facilities in the area, and composing and arranging electronic music and film scores (Tell Me That You Love Me, Junie Moon). He teaches electronic music at UCLA and UC Irvine Extensions.



## THE SYSTEM A SYNTHESIZER

A BASIC INSTRUMENT FROM THE 2000 SERIES

### INCLUDES:

- 1 RANDOM SIGNAL GENERATOR
- 3 VOLTAGE CONTROLLED OSCILLATORS
- 2 VOLTAGE CONTROLLED AMPLIFIERS
- 1 VOLTAGE CONTROLLED LOW PASS FILTER
- 2 ENVELOPE GENERATORS
- 1 KEYBOARD
- 1 POWER SUPPLY
- 3 FOUR INPUT MIXERS
- 1 CABINET
- 20 PATCH CORDS

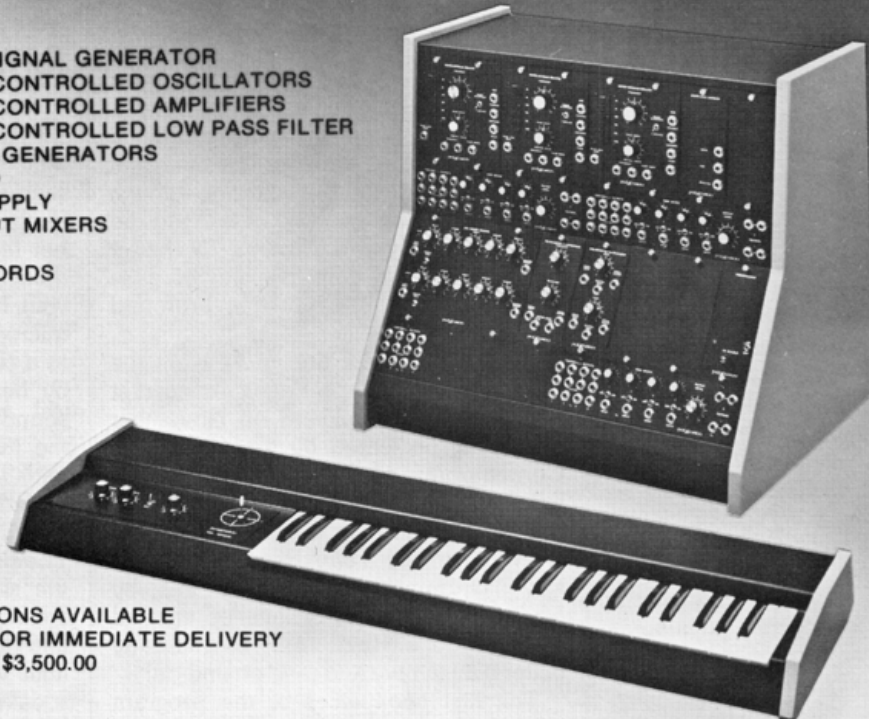

- MANY OPTIONS AVAILABLE
- IN STOCK FOR IMMEDIATE DELIVERY
- LESS THAN \$3,500.00

PLEASE WRITE TO:  
POLYFUSION, INC. 160 SUGG ROAD, BUFFALO, NEW YORK 14225

# SUBSCRIBE

Fill out this card, include a check or money order payable to Synapse and send it to Synapse/Subsription Dept., 2829 Hyans St., Los Angeles, Cal. 90026.

Enter my name on the Synapse subscription list. Enclosed is \$6.00 for a 1 year/6 issue subscription.

I want to know more about Synapse. Enclosed is \$1.25 plus 50 cents postage for the current issue of Synapse.

Name \_\_\_\_\_ City \_\_\_\_\_  
Address \_\_\_\_\_ State \_\_\_\_\_ Zip \_\_\_\_\_

# SUBSCRIBE

Fill out this card, include a check or money order payable to Synapse and send it to Synapse/Subsription Dept., 2829 Hyans St., Los Angeles, Cal. 90026.

Enter my name on the Synapse subscription list. Enclosed is \$6.00 for a 1 year/6 issue subscription.

I want to know more about Synapse. Enclosed is \$1.25 plus 50 cents postage for the current issue of Synapse.

Name \_\_\_\_\_ City \_\_\_\_\_  
Address \_\_\_\_\_ State \_\_\_\_\_ Zip \_\_\_\_\_

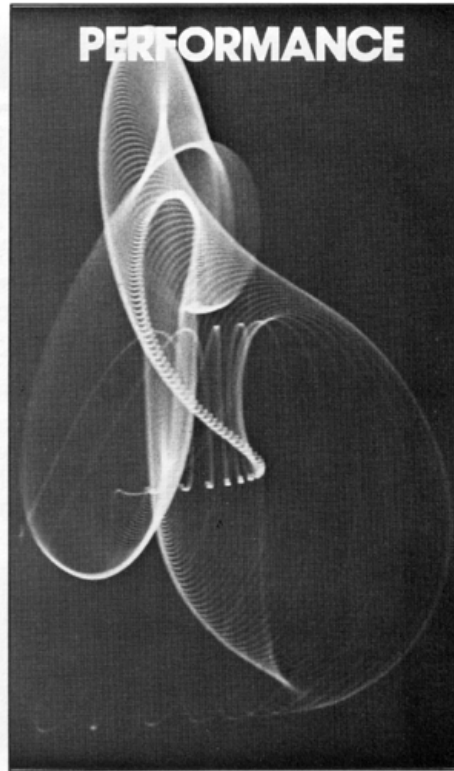

© 1976 MAGGI PAYNE

## MAGGI PAYNE

AT

## MILLS COLLEGE

How often can you leave a concert of new and/or electronic music and recommend it without qualification to anyone you meet? When was the last time that you were saddened by the thought that a tape piece would soon be over? And did you ever find yourself unable to chatter with friends at a concert's end because the music had made such a profound impression?

All three of these and more were the result of hearing Maggi Payne's concert at Mills College in Oakland on November 20, 1976, presented by the Center for Contemporary Music. This was an experience which will rank in my mind with the first time I heard "In C" or "Rainbow in Curved Air" by Terry Riley, or when I saw "Drumming" performed live by Steve Reich and Musicians or entered David Tudor's "Rainforest." (Is there any better way to rave and rave on and on?)

The first two pieces of the program were for tape and slides. The opening was entitled "Fare Well." A tape of

Maggi's flute playing was accompanied by visual images of deserts and sand. The pictures were shot with a creativity of camera angle and sensitivity to texture that added an otherworldly quality to the subject's simple reality. The mark left by a raindrop on the sand became a crater on the moon. A piece of straw was captured with the power and essential being found in a Zen watercolor master's single stroke painting.

Next came "Spheres." The sounds here were all electronically generated and were very sharp and agitated whereas the other piece had been whistling and airy. Rather than use a great variety of timbres for each piece, the range was distinctly limited. For long periods one type of sound would hold the fore and when the glass-like beads of sound gave way to clickings and boimps it was a purposeful transition as controlled and surprising as any of the "great modulations" which send theory teachers into rapture as they analyze the works of Wagner, Debussy, or Beethoven for their less-than-fascinated students.

The slide screen showed miraculously well chosen shots of various circular shapes, all of which seemed to gain a revolving quality from the music. All of these slides were made by Maggi from pictures of oscilloscope patterns. The patterns were generated mostly with Moog equipment. Some slides had been manipulated and recopied in the dark-room. The images were so intricate and beautiful that it seems staggering that they were produced with as common a device as the oscilloscope. What no digitally controlled anything?

"Hum" for four-channel tape of flute with live flutist followed. Maggi played the flute into a microphone set at what seemed an exceptionally high gain. What happened was like a dance. She rooted her feet in front of the microphone and then she would begin playing a sound with her body swung back beyond the microphone's reach. She then moved into a closer position to the mike, followed by her fading back again. Most of the sounds were just breath running through the flute. Sometimes the taping of the pads or vocalizing while blowing was added. The rush of air in the flute produced beautifully colored white sound. The skillful adding of notes on the flute or the singing created the idea of several sounds; white sound in the foreground and half heard melodies beyond. The live flute was routed through the two front speakers first and then to the rear with a 40m/sec. delay done in an analog manner.



The final work of the evening was "Allusions" for "four channel tape, dancers, special lighting, and video-processed film." This work began with another electronic tape and three women dancers on stage (Robin Kirck, Peg Ahrens, and Maggi Payne). There were 10 foot lights of various colors which cast shadows of the dancers on the wall-size projection screen behind them. Not just shadows, but colored shadows. It was as though each dancer had a corona or aura which the lighting disclosed. Sometimes there would be as many as three distinct and differently colored images of a dancer. The movements were slow and solemn, creating statuesque profiles on the wall.

On some indiscernible cue the lights went out and the dancers left the stage. The tape which had been playing continued, becoming the soundtrack for the film. The film itself was a swirl of colors with small vague areas moving within the patterns. These moving areas were from a video tape of two dancers (Carla Blank Reed and Maggi Payne). This video was processed so that only the lightest areas would be visible. For instance, things like the black leotard or the dancer's eye sockets wouldn't be visible at all, but parts of an arm or leg as it caught the light during a turn would be seen. These would then fade into the darkness as the dancer continued her movement and then the side of her face might catch the light.

Maggi accomplished this effect by first making a black and white video tape of her and Carla dancing. From that she made a black and white tape using video feedback which gave expanded sets of coronas around the figures. This was then colorized and filmed. After that followed optical printing and some processing manipulation, the result being what the audience saw that night.

This concert was not perhaps the most adventurous or Avant-Garde. The music was not experimental by many definitions. The techniques used (synthesizers, the analog delay, four channel sound, video processing) have passed from being "state of the art" to perhaps what could be called "state of the popular media." What this concert showed was that this music or music made with these means can be accessible without relying on the cliches of the musical past either popular or classical. That there's a world still to be discovered that's not rock or jazz exactly nor Avant-Garde "art" music precisely. It may partake of these and more, but it's truly a total that's more than the sum of these parts. — Bob Davis

# SERGE MODULAR MUSIC SYSTEMS

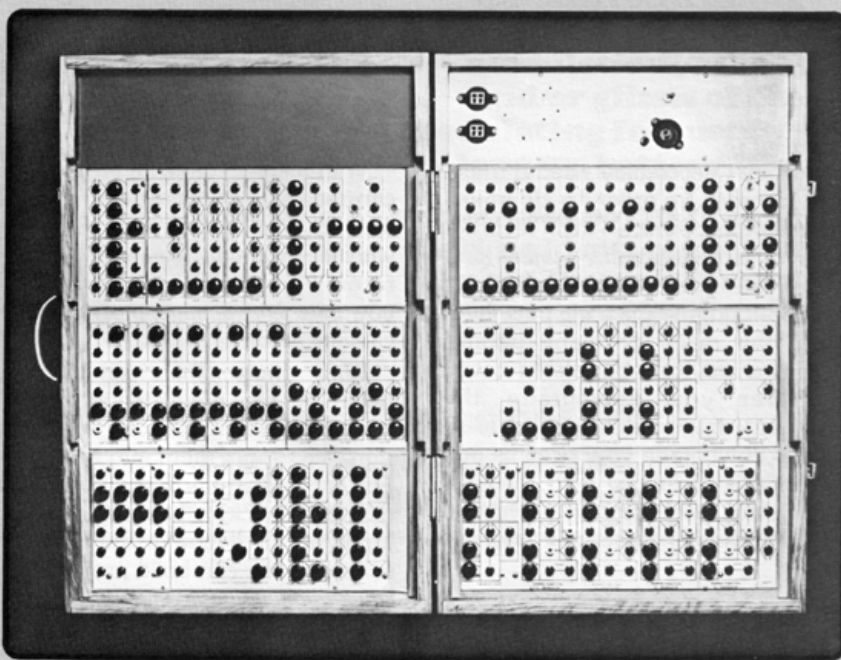

## THE AFFORDABLE STUDIO MUSIC SYNTHESIZER

*If you are shopping around for a synthesizer or thinking of expanding your present system with some new modules, be sure to check us out. We are SERGE MODULAR MUSIC and we manufacture the SERGE MODULAR MUSIC SYSTEM. Our systems represent the state of the art in voltage controlled equipment. Many of our modular functions are unique to the SERGE SYSTEM, and not available from any other source. Moreover, the SERGE SYSTEM is affordable. Module per module our systems cost from half to a third of the cost of comparable commercially available modular systems. Our systems cannot be bought at stores, we sell direct to musicians, commercial installations and schools. Furthermore, we can save you even more money if you buy our systems in kit form. (Note too that our kits are like no other kits. Most of our kit-modules are shipped complete with pre-assembled and tested P.C. boards, therefore ensuring that our modules will work for you right off the bat after you have finished wiring them up).*

*Send us a dollar for our newest catalog (refunded with your first purchase) or call 213-461-7987.*

*We think you will be pleasantly surprised about what SERGE MODULAR MUSIC can do for you.*

### SERGE MODULAR MUSIC

Marketing Dept. G

1107½ N. Western Ave., Hollywood, CA. 90029

# What To Do Until The 4 Track Arrives

by CRAIG ANDERTON

You don't necessarily need a multi-track recorder in order to do multi-track recording. Sure, a 4 track recorder with sync is a wonderful device; (and one of the surest cures for musical frustration) but the price tag puts them out of the reach of many people. There is a way out, but also a catch. Whenever you downgrade the equipment involved, you have to similarly downgrade your dreams and expectations of fidelity with the final product. But there are several ways to hear more than one track at a time.

FIGURE 1

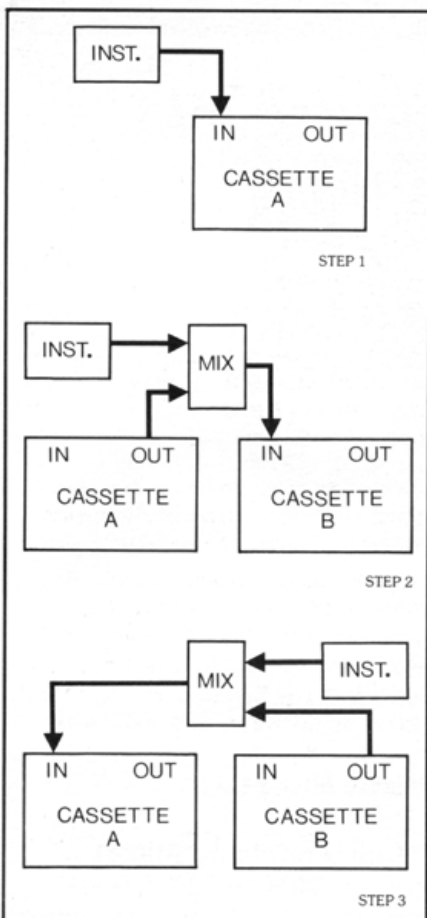

With a cheap cassette recorder, you can record your instrument, then play back that recording and play along with it. Granted, you can't make a recording of this combined sound, but you can if you have more than one cassette recorder...

With more than one cassette recorder, we need to introduce a mixer, something that can take several signals and mix them into one output. For our budget purposes, you can use a Radio Shack or Lafayette type four input mixer. If you're the do-it-yourself type, you can build project #18 in the book "Electronic Projects for Musicians" (8 in, 1 out mixer) and get excellent performance for a comparable price.

Having obtained a mixer, you may now record onto cassette A, then (see figure 1) add your instrument along with the output of A on to B. Then, you can take this composite B track, and your instrument, and record into A. The limiting factors are: 1) the amount of noise you build up, as you layer track upon track, 2) the amount of distortion you accumulate (2% distortion repeated five times is kind of nasty sounding), and 3) the aggregate wow and flutter. All of these affect the first tracks the most, since they are subjected to repeated degradation every time you bounce from one recorder to another.

The better the cassette recorder you use, the better off you are. Two high quality consumer type decks, equipped with Dolby and using good tape, can actually yield some pretty good results. You can even do the process in stereo, using two mixers as shown in figure 2.

With a three head machine capable of sound-on-sound, you can also build up about five tracks before the noise becomes unbearable. What you're looking for is a good reel to reel

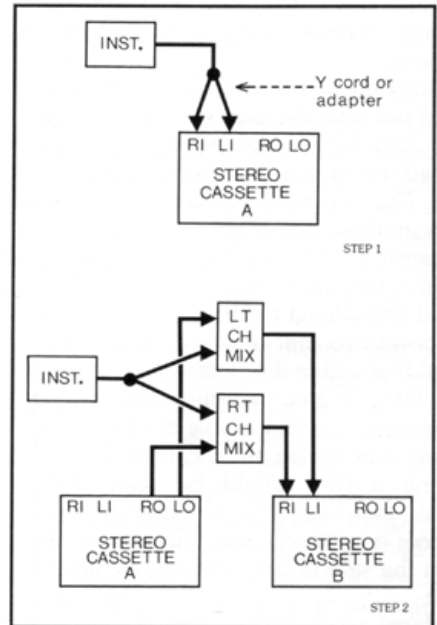

FIGURE 2

machine, that can go to 7.5", and which can listen to one track while you're recording in another. Some decks can do this, some can't. If there is a switch that switches the output of the recorder from *TAPE* (from the playback head) to *SOURCE* (the signal arriving at the tape recorder), and if you can engage the record function separately for each channel, you're golden. See figure 3 for how to hook up the mixer; some machines have an internal mixer with a sound-on-sound level control. Any instructions provided with the machine will detail quirks peculiar to that unit if it deviates from the description here. As you ping-pong from track to track you will build up some fine sounds and some first-class white noise.

With any of these methods, you are looking at long odds on making a perfect tape. But there are some steps you can take to get the most out of

what you're doing, to the point where the tapes will have acceptable to good quality. Keep the heads cleaned; (every time you sit down to use the recorder, clean them . . . if you're a fanatic, which you probably are). Tape heads must also be routinely demagnetized. Demagnetization is not as easy as it sounds; read the instructions that come with your demagnetizer. Turning the unit on or off too close to the heads, or failure to use a random, circling motion as you back the demagnetizer away from the head, can actually make things worse. Several passes are inadvisable; do it right once every 20 hours of use or so and you'll be fine.

Use the best tape possible, especially the extended range kind, then make that tape do its job by hitting it with the highest signal level possible. This has a disadvantage: you increase the chance of crosstalk, where some of the signal

TURN TO PAGE 34

FIGURE 3

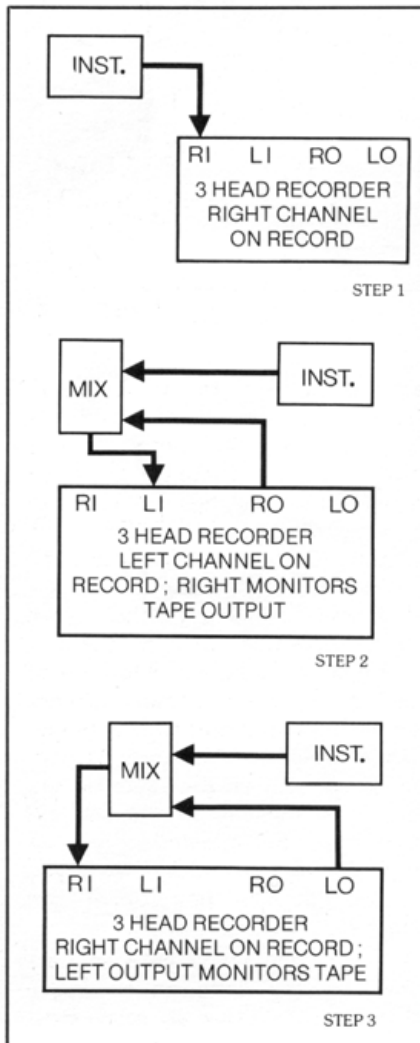

**Ultra stable oscillator  
with foot selectable  
preset frequencies •  
automatic squelch  
inputs for optional  
pressure sensors  
(pedals) controlling  
the amount of  
modulation (0-100%)  
and/or glisses of the  
modulating frequency •  
long 9v. battery life.**

**Cost: \$150.00 C.O.D. only,  
Calif. residents please add  
sales tax. Pressure Sensors  
are \$32.00 each.**

**SYNERGY ASSOCIATES  
1107½ N. Western Ave.  
Hollywood, Calif. 90029**



**SYNARE**  
\*percussion synthesizer

The beat goes beyond. The world of electronic percussion is yours with the Synare P.S.™ . . . the first fully integrated percussion synthesizer.

Put thunder, lazy days, chimes, brake drums, gongs, jackhammers, rain, rush hour . . . under your sticks. Designed for use with or without a drum set, the Synare P.S. is played with sticks like a drum, has bounce, and requires only a conventional sound system.

P.S. Write for information about the Synare P.S., the first fully integrated percussion synthesizer, and the dealer nearest you.

Suggested retail \$695.00



**STAR INSTRUMENTS INC.**  
Dept. S, Box 71, Stafford Springs, Ct. 06076 tel.(203)684-4421

# Computer Meets Keyboard or "look ma, no hands"

by PRENTISS KNOWLTON

A new computer music system is available which brings together a pipe organ and a small computer. The system in its most basic form includes a small pipe organ, a Digital Equipment Corporation PDP-8 computer, and a Teletype. More recently, over the last two years, the PDP-8 has resided at All Saints Episcopal Church in Pasadena, California, connected to their large (in excess of 5000 pipes) classic organ. Ordinary (preferably extraordinary!) sheet music is programmed onto paper tape using the Teletype paper tape punch. Programming of sheet music can be learned by anyone in less than an hour. The PDP-8 reads the music with its high speed paper tape reader and plays it on the pipe organ. At All Saints Church, selection and control of organ stops was added to the system. The music can be as complex as desired and played at any tempo.

The present system has placed emphasis on long distance remote control of the organ pipe by the computer. A multiple conductor cable of up to 300 feet coming out of the computer connects to a box full of digital logic to perform pipe addressing and selection. The interface box has 30 computer connectors. Each connector can handle 24 functions, such as pipe or organ stop. By keeping the computer distant from the organ, noise due to such things as the Teletype or ventilation fans on the computer is easily eliminated.

The operation of the system is much like the operation of an ordinary player piano. One merely mounts the desired roll of paper tape on the high speed reader and starts the computer. The typing in of various simple commands allows the performance to be varied. In addition, the computer typically reads a dozen measures ahead of where it's playing; so it is possible to start rewinding a music tape long before it is finished playing.

Certain philosophical goals have influenced the development of this computer system. In contrast to previous computer music work which used the computer to synthesize various electronic sounds, this system uses the computer to control a real mechanical sound or natural sound. Natural sounds produced

by a pipe organ are very complex and difficult to imitate. Thus, it seems much easier to control a natural sound directly. Electronic sounds of corresponding complexity for the duration of only one second can take the biggest computers available today as long as a minute to compute. So, as much as an hour of computer time is sometimes needed for a minute of tape recorded music. On the other hand, very little computing is required to control a pipe organ, since the complex sounds of the pipes are available to be turned on and off like switches. So, it's a very simple matter to play the organ live.

In contrast to previous computer music work which used the computer to

compose music, this system focusses on human compositions. As has been wisely stated: "Computers are capable of producing great quantities of trivia in a short time."

The computer accompaniment of a silent movie is an exciting and now imminent possibility, for since December 1, the computer has taken residence at the soon to be reopened Crown Theatre in Pasadena, where there is installed a genuine "Mighty" Wurlitzer Theatre Pipe organ. Because the computer in the present system times notes to an accuracy of one-ten-thousandth of a second, it would be possible to cue, for example, the beginning of a musical scene to synchronize with the 5,683rd



Prentiss Knowlton with his pipe organ, teletype and PDP8 computer.

frame of a film. Pratfalls would be a simple matter. Similarly, musical background on the soundtrack of a sound film could also be accurately cued.

The use of this computer music system to play music of arbitrary complexity opens the door to new horizons for experimental composers. Imagine, for example, six independent melodies being played on each of six independent ranks of pipes and in six different rhythms. Such a composition would pose no difficulty for the computer. In fact, it would pose little additional trouble to the computer if each of the six ranks of pipes were microtonal, based on say, 31 notes per octave.



A key circuit from Knowlton's interface system.

Finally, the use of this music system as a composer's aid is promising. Fig. 1 suggests an elaboration to the current system by adding an interactive keyboard, CRT display, and hard copy plotter. For example, an orchestral composer could interactively enter and preview sections of a piece without a real orchestra. He could, by hearing his piece played at actual tempo, perhaps gain greater insight into the overall cohesiveness of a section. By having a tireless virtuoso at his fingertips, he might be more encouraged to experiment with various changes and evaluate their effect on the composition as a whole.

We have just started opening new vistas in the field of music for this creation. At the outset it offers great, even unlimited potential when applied commercially. The system can be adapted to various methods of operation, and in compact form it can be used anywhere.

For those desiring a more concrete picture of the systems capabilities, a record album has been produced on the 90-rank pipe organ at All Saints Church entitled "Unplayed by Human Hands."

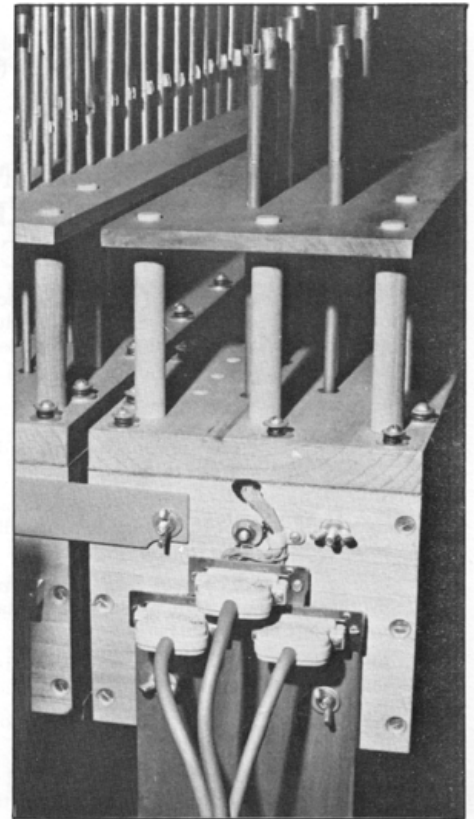

Detail shot shows computer interface connection with organ pipes.

## SCCS isn't growing, it's exploding ...

"If the SCCS continues to grow at its present rate [from 2 members to 8000 the first year], in four years all mankind will be dues-paying members."

*Popular Science, December 1976.*

The microcomputer is the most significant, exciting, fast moving, technological advance of our times...

### JOIN SCCS

*The international computer society*

Annual dues \$10

includes SCCS Interface Magazine.

Southern California Computer Society

P.O. Box 54751 Terminal Annex  
Los Angeles, California 90054

### Computers in Music Symposium

February 19

Orville Wright Auditorium

Send \$4 for tickets

(Open to members of SCCS and IEEE and their guests and to subscribers of SYNAPSE).

## PATCHWORK SOUND



### Synthesizer Specialist

- discounts on sales and studio session rentals
- instruction
- modifications
- consultation
- production

14759 Hesby Street  
Sherman Oaks, California  
(213) 990-2984 91403

THE LOS ANGELES CENTER  
FOR ELECTRONIC MUSIC  
announces  
**THE FIRST ANNUAL  
LOS ANGELES  
ELECTRONIC MUSIC FESTIVAL**

An electronic gathering of the tribes is scheduled in the month of September, in Los Angeles, to celebrate the phenomenon of Music and technology with five (5) classes of entry:

1. Tape alone
2. Tape and instruments
3. Synthesizers alone
4. Synthesizers and instruments and/or voice
5. Film with electronic scores.

A distinguished panel of electronic music composers and designers of state of the art equipment will select the entries to be performed at the festival.

Live performance entries selected will be performed by LEM, the Synthesizer Band with other guest artists and must contain appropriate scores and parts.

All entries **must** be submitted by May 14, 1977 and entrants selected will be notified by June 15, 1977.

All tapes, scores and proposals must contain the composer's name, address and phone number.

Please include a self-addressed stamped envelope if tapes and score are to be returned, otherwise all tapes will become the property of the LACEM library.

All are invited to enter, attend and participate.

**Address all entries to: LACEM FESTIVAL  
8615 Santa Monica Blvd.  
Los Angeles, Ca. 90069**

expert  
**SYNTHESIZER**  
programming  
and  
instruction

state-of-the-art equipment  
**(213) 463-8772**

# LISTINGS

## MANUFACTURERS

ADVANCED TOOLS FOR THE  
ARTS  
P.O. Box 825  
Tempe, Arizona 85281

ALAN LABS  
Box 434, Van Nuys, Calif. 91408

ARIES INC.  
119 Foster St., Peabody, Mass.  
10960

ARP INSTRUMENTS  
320 Needham St., Newton, Mass.  
02164

JOHN BLACET\*  
4019 Chico Ave., Santa Rosa, Calif.  
95401

BUCHLA  
Box 5051, Berkeley, Calif. 94705

CFR ASSOCIATES\*  
Box F. Newton, New Hamp. 03858

COMPUTONE INC.  
P.O. Box 433  
Norwell, Massachusetts 02061

CONCERT COMPANY\*\*  
3318 Platt Ave., Lynwood, Calif.  
90262

DAVEL  
Box 279, Verdugo City, Calif. 91246

D.B.L. ELECTRONICS  
502 Sherman  
Canton, Mass. 02021

EMu SYSTEMS  
3455 Homestead Rd., No. 59, Santa  
Clara, Calif. 95051

ELECTRONIC MUSIC STUDIOS  
(LONDON) LTD.  
277 Putney Bridge Road, London,  
England SW152PT

ELECTRONIC MUSIC  
LABORATORIES  
P.O. Box H, Vernon, Conn. 06066

FARFISA  
1330 Mark St., Elk Grove Village,  
Ill. 60007

HAMMOND  
4200 Diversey, Chicago, Ill. 60639

HARVEST PRODUCTIONS  
Gregory Kramer  
135 W. Broadway, New York, N.Y.  
10013

IONIC INDUSTRIES  
128 James St., Morristown, N.J.  
07960

KORG/UNIVOX/MERSON  
75 Frost St., Westbury, N.Y. 11590

MOOG/NORLIN  
7373 N. Cicero Ave., Lincolnwood  
Ill. 90646

Customer Service: Box 131,  
Academy St., Williamsville, N.Y.  
14221

M M ELECTRONICS  
French's Mill, French's Road,  
Cambridge CB4 3NP, England

MUSITRONICS CORPORATION  
Sound Lab 10, Rosemont, New  
Jersey 08556

OBERHEIM ELECTRONICS  
1549 Ninth St., Santa Monica,  
Calif. 90401

OCTRON  
1346 Bayport Ave., San Carlos,  
Calif. 94070

OZNIE/PROCESS ELECTRONICS  
Box 7, Centerville, Penn. 16404

PAIA\*  
Box 14359, Oklahoma City, Okla.  
73114

POLYFUSION INC.  
160 Sugg Road  
Buffalo, New York 14225

ROLAND  
2925 South Vail St., Los Angeles,  
Cal. 90040

SEQUENTIAL CIRCUITS CO.  
7150 Rainbow Dr., No. 7, San  
Jose, Calif. 95129

SERGE MODULAR MUSIC  
1107 1/2 N. Western Ave.,  
Hollywood, Calif. 90029

STAR INCORPORATED  
Box 71, Stafford Spring, Conn.  
06076

STEINER-PARKER  
2258 South, 2700 West, Salt Lake  
City, Utah 84119

STRIDER SYSTEMS  
P.O. Box 2934, Norman, Oklahoma  
73070

SYN-CORDION  
32-73 Steinway St., Long Island  
City, N.Y. 11103

SYN-KEY  
spg 117 W. Hintz Road, Wheeling,  
Ill. 60090

THINC- TECHNICAL HARDWARE  
INC.  
P.O. Box 3609  
Fullerton, California 92634

VAKO SYNTHESIZERS, INC.  
4651 62nd Ave., N., Saint  
Petersburg, Fl. 33565

WASATCH MUSIC SYSTEMS  
P.O. Box 9175, Salt Lake City,  
Utah 84109

YAMAHA INTERNATIONAL  
Box 6600, Buena Park, Calif. 90620

360 SYSTEMS  
2825 Hyans St., Los Angeles,  
Calif. 90026

### NOTE:

\* manufacturer makes kits only

\*\* manufacturer makes both  
kits and finished product

# Walking Ring Sequencer

by JOHN BLACET

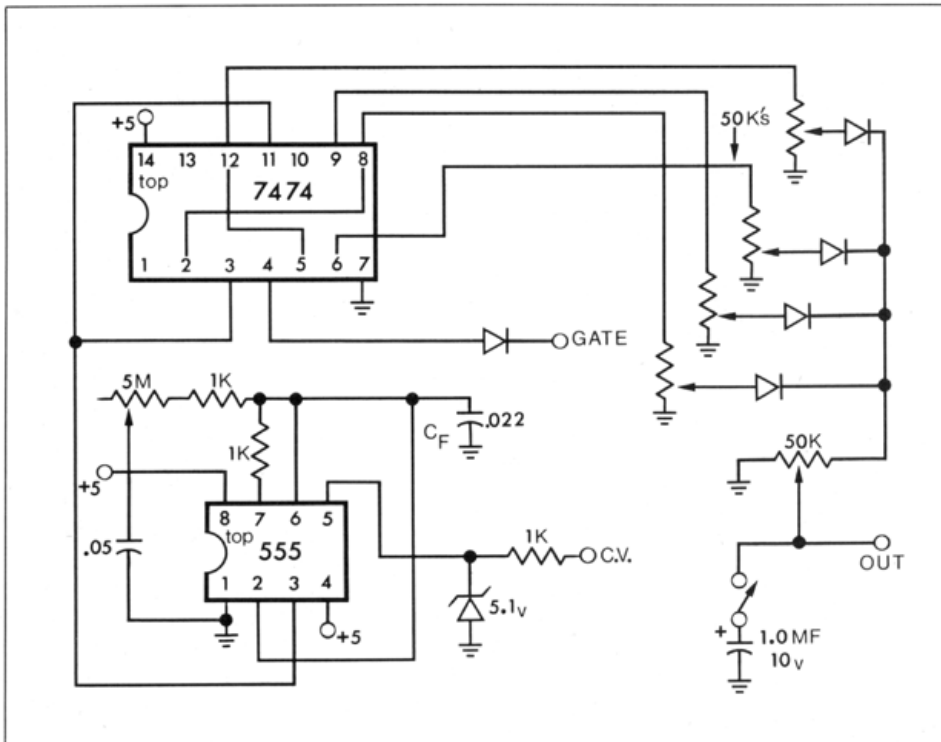

Walking ring sequencer schematic.

This simple circuit is quite useful for generating a number of functions. It can be used for trilling, vibrato, or higher frequency FM. It will also provide voltages for note sequences, gating, controlling filters, VCA's, or any other V.C. module.

A 555 timer is used as a simple V.C. clock, with the 5 meg. pot. determining sequence speed along with the voltage at the C.V. input. This input will vary the speed with a positive voltage applied. This function is non-linear, has a 3:1 range, and increases speed as the voltage decreases. With the component values shown (5 meg. and .022), the range is 2 Hz to 7K Hz. Larger values of  $C_F$  will result in slower rates, and smaller values, faster ones.

A 7474 flip-flop is wired as a walking ring counter. The outputs overlap, so the final output is apparent as four steps and moving one of the four level controls

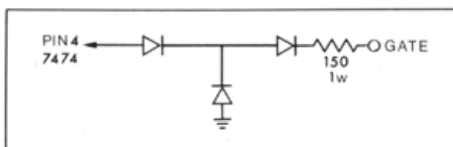

Optional gate protection circuit for negative voltages

moves the whole sequence. The primary disadvantage here is that individual notes are difficult to tune accurately, so that sequence should be run fairly fast in order to minimize note inaccuracies when controlling a VCO.

The sequencer can be turned off at the gate input with a ground. No connection or a positive voltage here will allow the circuit to operate. This input is protected from normal synthesizer positive voltages; but negative voltages should not be applied here, unless you use the optional gate protection circuit.

The 50K pot. on the output controls the level from 0 to 3.5 volts. The 1.0 MF capacitor and switch are used to provide a slide function.

The circuit can be assembled using a P.C. board, or as shown in the photo, a perf. board and wiring pencil or wire wrap. This is simpler and more compact especially if you are only building one. A discussion of these wiring techniques is provided in the April, 1976 *Popular Electronics*. This magazine is also a good place to look to for parts.

I used some unusual miniature 50K pots. for compactness. These are quite usable without knobs, but regular pots

can be used for better control. The miniature pots are available from Poly-Paks Inc.

Note the power supply is 5 volts and must be regulated. Higher voltages may destroy the 7474 I.C. If 5 volts is not available use a LM309K, LM340T, or LM340K, 5 volt voltage regulator.

Finally, if you have any ideas for unusual modules that you would like to see plans for in *Synapse*, or would be interested in a parts kit for this project, write to me in care of *Synapse*, P.O. Box 359, N. Hollywood, Cal. 91603.

## PARTS LIST:

- 1 7474 Flip-Flop
- 1 555 Timer
- 5 General Purpose Diodes
- 1 5.1V Zener Diode
- 1 .05 Ceramic Disc
- 1 .022 Mylar
- 1 1.0 MF 10V Electrolytic
- 3 1K Resistors 1/4 Watt
- 5 50K Potentiometers Linear
- 1 5 Meg. Potentiometers Linear
- 1 SPST Switch
- 3 Jacks

## OPTIONAL CIRCUIT

- 3 General Purpose Diodes
- 1 150 1 Watt Resistor

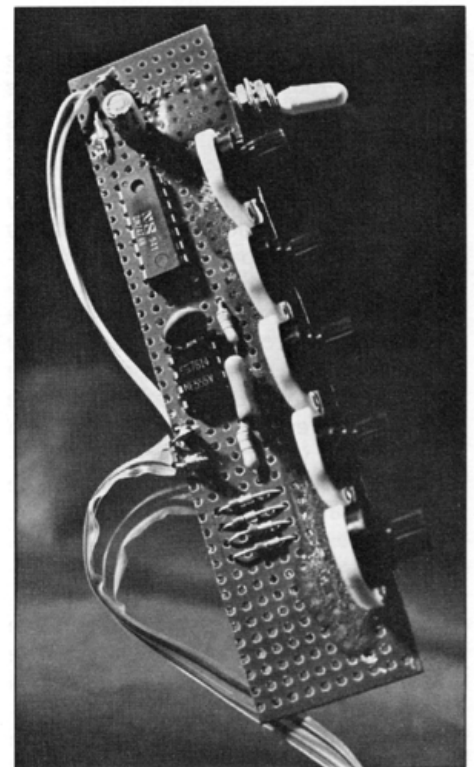

One possible way to construct the sequencer. Some parts, including the 5 meg. pot, are not shown.

# Liz Philips In New York City Sound Articulates Space

... perhaps the most important aspect of her work: that space is not only expressed as sound, it is, in fact, *made of sound*.

by RANDY COHEN

Nineteenth century composers wrote works to be played in laboratory conditions. The concert hall functioned as a carefully controlled setting to shield the audience from all sounds other than the composition itself. In much the same way, nineteenth century scientists studied individual phenomena in isolation from the environments such phenomena regularly occurred in. More recently, particularly since the influence of John Cage, composers have taken their work outside of these neutral spaces and allowed it to exist in a larger acoustic context. Likewise, contemporary scientists examine phenomena as they interact with their surroundings.

The works of Elizabeth Phillips not only co-exist comfortably with their surroundings, but, in a large measure, they are *created* by that interaction. Ms. Phillips creates spaces articulated by changing sounds responding to the presence of people within those spaces. They are three-dimensional spaces, approximately the size of a six-foot cube, created by radio frequency capacitance fields, somewhat analogous to giant theremin antennas. The activity of people within the field modifies electronic sounds made by a synthesizer. These are spaces to be explored with the ears more than with the eyes. They are sensitive to variations in people: their volume, surface area, conductivity, weight, distance from the ground, shape (especially sharp edges). Most of these parameters are time determinate.

She says of her work:

"In my sound installations, the presence and movement and/or the absence and stillness of the audience in areas of the room determine the combinations of tones of the sound-space. The audience finds — at the same time — that those sounds function to reveal changing three-dimensional forms which vary in depth and time."



PHOTOGRAPHS BY MARY LUCIER

An interactive R.F. capacitance system, Nam June Paik participating, the Kitchen, N.Y.C.

As you move through the space you discover its properties, perceive its edges, notice certain sensitive areas, and you learn all of this in the form of changing sounds. You are immersed in an acoustic space, in a system that is responsive to your actions.

Ms. Phillips designs her works for a variety of settings. She has composed pieces for dancers, for outdoor public gatherings, and for galleries. She installed "Broken/Unbroken Terracotta" at the Lions Gallery of the Senses in Hartford, Connecticut, in September of 1975. The composer, Earl Howard, a sometime collaborator with Ms. Phillips, described the work:

"Here is a fluid composed of sounds, whose shape is determined by its container. I will say only that a container is anything which actively holds sound. When there is stillness in the room one may notice that there are eddies, currents, some internal motions, which seem to flow independently. If one should move to interrupt a particular movement of sound he will find himself in a position of

partial or total control over the substance of his space (this sound fluid)."

Her pieces function as coherent musical entities, but Ms. Phillips cautions that: "It would be ridiculous to tape it, listen, and analyze my work as music. You would only be dealing with half of the piece." The other half, the spatial aspects, are discovered by physically exploring the space. However, her work can not be regarded simply as sculpture, as painter Cora Cohen indicates: "It isn't music or sculpture. You could treat it like music, and just listen, but . . ."

Her work is to be approached by involving yourself directly and actively with the space, by moving through it and experiencing its dimensions, its changes of sound and shape, and the underlying systems that determine these interactions. As you do this, you find that the sounds articulate the space, but not as a secondary characteristic, rather, in many ways, the sounds are the space, or, as Cora Cohen described it: "The sounds and the space, in a big way, are meshed."

Ms. Phillips created a space that was





"It would be ridiculous to tape it, listen, and analyze my work as music. You would only be dealing with half of the piece."

influenced in many ways by the Breugles painting of the wheat gatherers. She was interested in the proportions, edge placement, and scale of the painting. While this was a legitimate source of compositional material, it seemed unlikely that anyone in the audience would perceive the origins of her piece in the Breugles work. The systems that are employed to generate patterns are often inaccessible to a person exposed only to the final work. The inductive reasoning required to abstract such a system is quite difficult. However, after exploring this work of Ms. Phillips, Cora Cohen approached her and suggested that Liz should see the Breugles painting of wheat gatherers.

Cora acknowledged perceiving the similarities of proportion in both works, but felt that the relationship between the two was more intimate, one of tone, of atmosphere, and of texture. She noted the textural equivalent of the "fluffiness of the wheat" in the Breugles to the internal structures of the sounds in the Phillips work. In the painting, Ms. Cohen commented, "It is difficult to tell where the air is ending and the solidness of the ground

is beginning." Likewise, in the Phillips work, Ms. Cohen found a similar ambiguity of edges between the sounds and the physical boundaries of the space, a merging of the acoustic and the physical: tactile sounds. She added: "What I love about her work has to do with how close you can get with sound and space."

---

**They despise it. Engineers like to make systems closed. I am taking closed systems and making them unstable. What I'm doing is a very hard thing for them: making my fields unshielded.**

---

There is a point where they almost meet." This is a central issue in the work of Elizabeth Phillips, perhaps the most important aspect of her work: that space is not only expressed as sound, it is, in fact, *made of sound*.

Liz Phillips built her first responsive space when she was still in high school, in Englewood, New Jersey. She composed a piece using electric timers, lights, and pressure sensitive floor switches to turn on taped sounds. She has gone on to become a self-sufficient artist-technician, designing and building most of her own equipment. She learned her electronics at what was primarily a defense lab, as an artist in residence at the Riverside Research Laboratories. She has often worked in advanced technological settings, including a stint at the Center for Advanced Visual Research at the Massachusetts Institute of Technology.

The capacitance fields she now uses are of her own design, and are larger than any comparable fields in existence. However, the engineers she learned from were not always sympathetic to the problem of designing larger interactive fields.

"They despise it. Engineers like to make systems closed. I am taking closed systems and making them unstable. What I'm doing is a very hard thing for them: making my fields unshielded. I have to

**The motion of the people eating dinner, as they raised a glass, or moved a knife, was sensed by the field, and resulted in a change in the pitches of several oscillators.**

tune very high frequencies to a narrow range of sensitivity.”

It is only by making her fields unshielded that she is able to create spaces responsive to their surroundings. She is concerned with: “A system open to the environment. Extract a changing structure, as a sculptor extracts a shape from a stone, but structures that can change as radically as the environment changes.”

She is also concerned that her works exist on the human scale, that they: “Don’t become monumental — that you can understand small distances and proportions.”

When Liz began working with responsive spaces, she explored three basic technologies: light, radar, and RF capacitance fields. The light works relied primarily on lasers, both as a sensing device, and to display changing shapes and colors. She rejected this approach, believing that the lights imposed themselves too strongly on the space, making the shapes too overt, too apparent. The radar sensed motion by measuring the doppler shift in micro-waves reflected from objects. It was an excellent system to cover very large areas, and very broad motion. However, it could not distinguish between a person and a thing, as could the capacitance fields, nor could it operate with enough sensitivity to reflect small gestures, and so this system was also rejected. It was in the applications of the RF capacitance fields that she has found her greatest successes.

There has been a progression in the sophistication of her musical materials. Her early works used only a few tuned oscillators that varied in pitch, while recent works use a complex synthesizer of her own design and construction. One such early piece was the “Electronic Banquet,” performed at the New York Avant Garde Festival in 1971. People were invited to attend a formal dinner. The antenna of a capacitance field ran along the dinner table, under the table cloth. The motion of the people eating dinner, as they raised a glass, or moved a knife,

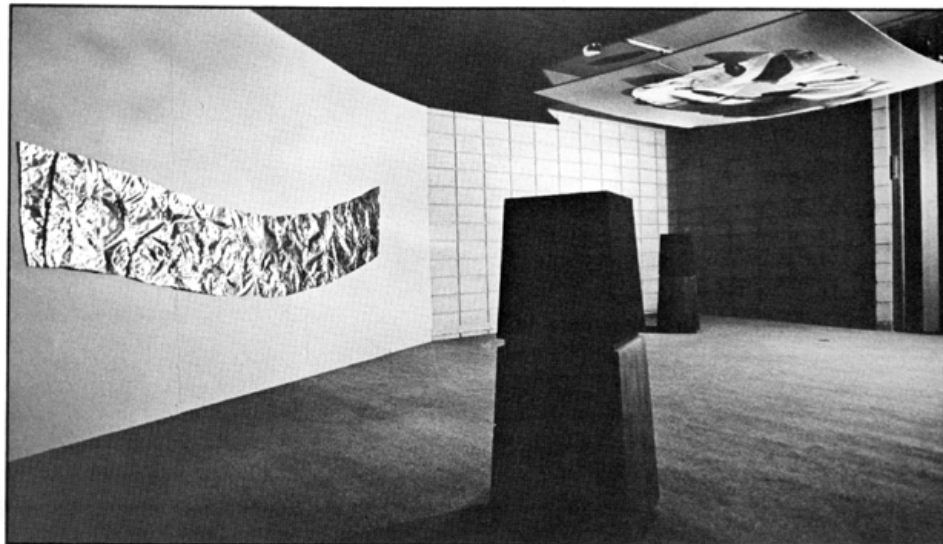

*A view of Ms. Phillips' installation at the Wadsworth Atheneum Museum, Hartford, Connecticut, November 1975.*

was sensed by the field, and resulted in a change in the pitches of several oscillators. Her first opportunity to use complex synthesizers came the following year. Joel Chadabe, the director of the electronic music studios at the State University of New York at Albany, invited Ms. Phillips to work at his facility. She now builds most of her own sound equipment, as well as the capacitance fields.

Her work is, perhaps, best experienced in galleries, where, she says: “You can see it if you move inside and explore it or if you sit outside and watch others move. Since the sounds are produced by the sum of the movements of many people, it is sometimes easier to tell from the outside. John Baldassari (the conceptual artist) came and wouldn’t go inside the field, he sat for several hours. I think he understood the space . . . or he was taking a nap.”

She is currently working on a large piece to be installed for the entire month of April, outdoors, at the City University of New York Graduate Center on 42nd Street between 5th and 6th Avenues. This piece, “City Flow,” uses time intervals determined by traffic light patterns throughout the city of New York. It will include an interactive space created by two overlapping RF capacitance fields to define near space, and a doppler shift radar unit to create the far space. The fields will be sensitive to people moving within them, and the sounds will be further modified by the information flow of the traffic lights.

“The Traffic Bureau is now using sonic scanners to sense car speed and density on main streets. These details travel as pulses on phone lines to high-speed com-

puters where the information is automatically accumulated, sorted and resolved. The resulting decisions are fed back, separately, to each individual traffic light within the system. Through this particle/global approach, traffic, in essence, controls its own rate of speed, as the lights are constantly adapting to the changing environment. The city, thus, can act as a living organism whose fundamental structure is a composition of physical modulations and dynamic transformation. Each musical composition will directly employ clusters and intervals of this city traffic information, and directly transform them into fundamental pitches, overtones, harmonic content, loudness, durations and rhythms. There will be constant flow/change; green lights are traveling up and down the avenue — somebody is always moving — there is always change.”

Liz is presently working on the problem of the specific sound material to be used, under a grant from the National Endowment for the Arts. The material will include concrete sounds in the area, particularly the sounds of traffic, and also electronic sounds and the saxophone playing of Earl Howard. All of the sounds will be subject to modifications triggered by activity within the fields, and the information flow from the traffic lights. In addition, the electronic sounds will be automated to respond to the concrete sounds, playing against the saxophone and the ambient noise. Despite the grand scale of this work, Liz Phillips hopes that it will not be a loud piece:

“I’m not going to fight the traffic. I have to live here. It will be as quiet as it can be . . . I hope, real quiet.” 

# GARY WRIGHT

---

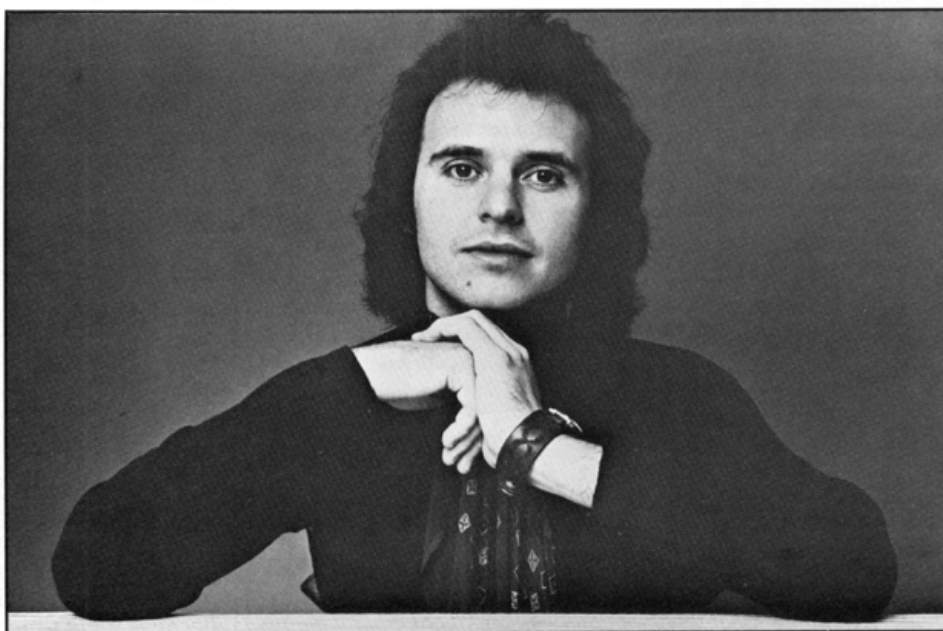

---

After the tremendous success of "Dream Weaver", Gary Wright has developed further his keyboard band format on "Light of Smiles", a newly released Warner Brothers L.P.

In this interview, Gary Wright discusses his success, musical techniques and opinions concerning the phenomenon of electronic music.

---



## GARY WRIGHT

by Doug Lynner

**Synapse:** "How did you first become interested in the possibilities of synthesizers?"

**Gary Wright:** "I think it came about through my having produced quite a lot and knowing a lot about techniques in the studio and also in the last stages of Spooky Tooth, getting involved with synthesizers and multi-keyboard playing rather than just playing one keyboard. From there it was just going out and buying some keyboards and putting them all to work. I made the demos for the *Dream Weaver* album in my basement with different keyboards, just with a little Sony mixer and then decided to do the whole album on keyboards. From there, it just kept snow-balling into newer keyboards, more keyboards. I would never go out and buy a keyboard because it's new or something like that. Only if it really relates to my music. So I think for the kind of music I write, it was just the perfect kind of marriage."

**Synapse:** "When you started going completely with keyboards, did you feel you were more in control of the total outcome because you were a keyboard player?"

**Wright:** "Yes, because I played on the *Dream Weaver* album basically all of the overdubs that were done. I played most of the instruments with the exception of the clavinet on a few tracks and the Rhodes. Quite a bit was that I wanted to do something totally different. I was tired of making albums with guitar, bass, drums."

**Synapse:** "One thing that especially interested me on the *Dream Weaver* album was that the single "Dream Weaver" was the biggest single from the album and yet was the piece on the album that used the most unusual effects. At one time people were saying these sounds aren't even music and now it's grown to the point that you can put this out on AM radio and people really accept it."

**Wright:** "That knocked me out too because it gave me so much more space to create in. When you have a #1 single that has so much electronic stuff on it, it shows that there's really an area where people are digging it and that's great. The important thing is that I interfaced it with music. It wasn't just electronics. Most experimental types of electronic albums, Morton Subotnick, people like that, have been just electronics and they tend to sound really cold, I think, and a bit off to a lot of people unless you're just into that kind of thing. But for the masses, when you can use both of the things together, you've bridged a gap."

**Synapse:** "Were you aware of the seeming contradiction between elements when you were putting together *Dream Weaver* in that on one hand you were writing a commercially viable song and on the other hand you were using what were non-commercial effects? Was it conscious?"

**Wright:** "It's funny, because now that I recall, I don't remember if when I finished the album, the title was going to be *Dream Weaver* or not, but when I put the song on the album, I didn't make it as a single. As a matter of fact, that was one of the most progressive tracks on the album. So I consciously didn't create it to be a single. As a matter of fact, it's 4½, 5 minutes long in its unedited form. When the album was done, people started saying they liked "Dream Weaver" so it turned out really nicely. The first single that was produced was "Love is Alive" and it didn't happen the first time it came out. Everybody was saying 'the most played track on FM radio is "Dream Weaver" so we had better go with it.' That seemed like the best thing to do at the time, so we released it. It was really a left field thing. I didn't plan it like that."

**Synapse:** "What is the name of your new album?"

**Wright:** "It's called the *Light of Smiles*."

**Synapse:** "How has your music changed from *Dream Weaver*?"

**Wright:** "Well, I think the songs are better, the production is better, the

playing, the singing . . . it's just a better album. It's got a lot more electronic things on it."

**Synapse:** "Is the album dealing with any sort of thematic concept?"

**Wright:** "Not as a total concept, no. There are three songs linked called "Time Machine," "I Am the Sky," and "Who Am I," which deal with a person going back through past incarnations in search of his true identity in a time machine. That's the biggest theme really, but it's just three songs; not the whole album."

**Synapse:** "What kind of instruments are you using now? Is it still a totally keyboard band?"

**Wright:** "Yes. The Oberheim polyphonic is basically featured, creating all the orchestral sounds, the woodwinds, some of the string sounds, the flutes, things like that. The ARP string ensemble I used again, the Rhodes, an acoustic piano this time, the clavinet. I did all the basics on a Mini-moog. My solos were about 50/50 Moog and Oberheim."

**Synapse:** "You mentioned before Morton Subotnick. He seems to represent one extreme of electronic music accepted by the record market. It seems that Tomita, Larry Fast, and Walter Carlos represent the other extreme. They use electronics to the same degree except their approach and vision of it is polar. Tomita, for instance, creates quasi orchestral works with a rather mainstream sense of drama while Subotnick seems more introspective. Maybe the drama is more personal."

**Wright:** "My own personal taste is . . . well, I would probably put on a Tomita album instead of a Subotnick album, only because there's more warmth in the music and warm music appeals to me. I think Tomita's "Snowflakes are Dancing" is a feat because he recorded it on just a sony mixer and a Sony tape recorder. I like the first album more than the later two. I think, too, that the more far out electronic things like Subotnick's "Sidewinder" are very interesting. I think in terms of visuals a lot. I can see "Sidewinder" in a Salvador Dali sort of film whereas Tomita is more like "Fantasia." Both are valid, but you're right, they are on opposite poles of the spectrum. Tomita, to me, being more warm and Subotnick more towards the abstract."

**Synapse:** "Do you use visuals much in your stage performance?"

**Wright:** "I will be. I've been using them, but only to a limited extent because I wasn't really headlining, but this year I'll be headlining when I go out. We'll be

using video and rear projections; the music really lends itself to that."

**Synapse:** "Do you think there's any one person responsible for getting synthesizers out there and accepted in the commercial record market?"

**Wright:** "I can only judge from my own influences and they basically came from Stevie Wonder and Tomita. I was aware of Rick Wakeman and Keith Emerson's things and Yes but I don't think there was any one person. All of the people I mentioned contributed to a certain degree. You hear loads of synthesizers on a lot of black records too. The Commodores, the Ohio Players, a lot of black groups use synthesized bass and things like that. Even the Bee Gees use synthesized bass but personally on a lot of those records, the synthesized bass is too obvious. I prefer mixing them more subtly so you're not really sure that it's a real bass or what kind of instrument it is. It's hard to say; I think it's been more of an evolution because when all those keyboards first came out, they were so expensive that you had to be almost a superstar to be able to afford to use them. Gradually, as they became more marketable, little bands, club bands, things like that, are now starting to be able to go out and buy them. They're more accessible. I think now with my having played so many concerts in this country with a portable keyboard, you probably will start to see a lot of bands now with that kind of aim or where at least a piano player who's a good singer and song writer, who lacks his communication with the audience due to being restricted to having to sit down all the time, will be able to walk up and stand up and sing and that's important."

**Synapse:** "I've been hearing a lot of people saying that synthesizer is the same as guitar was in that they're so available and popular that a lot of people play but few are really very good at it."

**Wright:** "That might be true. I don't know. You see, when you're talking about a good synthesizer player, there are two facets. There's the programmer and there's the player. You can be both but it takes time and you can't change the color of sound you're using quickly if you're playing. You have to stop and switch things around unless you're using preset techniques. I think if you have a tasty keyboard player you're alright. It's the same keyboard, you're just using it to play synthesizer so that's the bottom line of judging someone's playing abilities. Regarding the programmer and how well he can program, it's another thing because a lot of people are excellent

programmers but they're lousy players. I don't know too many people who are both brilliant programmers and brilliant players."

**Synapse:** "Do you program your own instruments?"

**Wright:** "I program my Moog, all the bass sounds and the solo sounds. I didn't program the Oberheim on the album because I wasn't that familiar with the instrument. Certain things I programmed but to get more of the orchestral kind of sound, I used Gary Melkie from Oberheim. He's a really brilliant programmer. There are a lot of players around who will see an instrument like that and it will look so complicated they'll fool around with it a little bit and then start playing it and be happy with the sound. Really, with synthesizers, a person's good ability is determined by his knowledge of sound and the kind of sound that he wants and knowing how to get it and not just settling for "well, that's

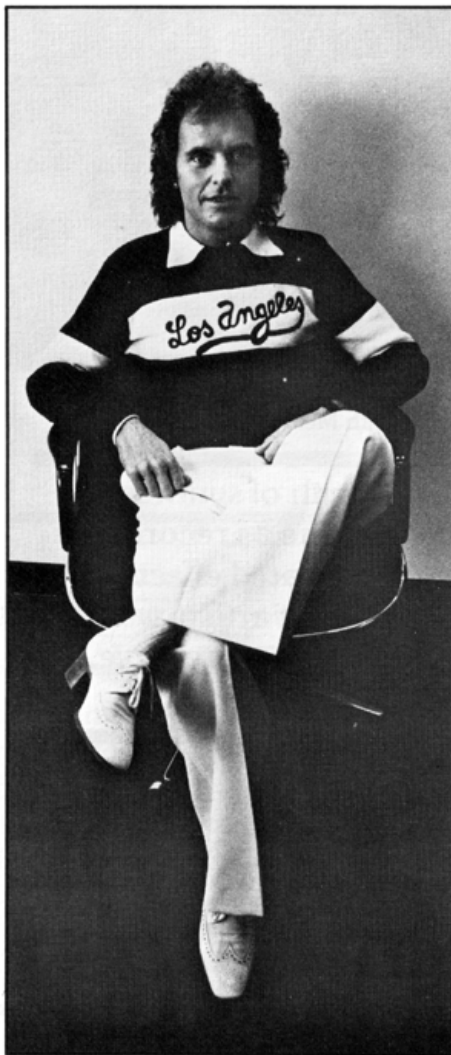

PHOTOGRAPHS BY BILL MATTHIAS

"I can see Subotnick's 'Sidewinder' in a Salvador Dali sort of film whereas Tomita is more like 'Fantasia'."

okay." That's really important and I think in my own instance I can relate to it just because of having produced so many albums in the studio and knowing quite a lot about sound. I know what each knob does and I know what kind of sound I want."

**Synapse:** "Where do you feel that the use of synthesizers in popular music will take popular music?"

**Wright:** "I think it will just add different dimensions of color to the sound. I think music will always stay basically the same because that's the emotional level you're communicating to people on. I think the strata of sound you put on top of that is going to be the difference; whereas before, it was acoustic guitar, piano, organ, I think it will get more towards polyphonic synthesizers or whatever electronic device you want to add to it. I think that's the change that's going to be. I don't know whether in fact you can generate a specific kind of music like 'synthesized rock' as opposed to say 'Reggae rock.' It's hard to say. But I really think the bottom line is always the music. You'll probably find though you'll have more things like Tomita; people getting interested in that kind of thing, there will be more instrumental albums out."

**Synapse:** "Have you started dealing more orchestrally with your music as a result of using polyphonic synthesizers?"

**Wright:** "Oh yeah. I know now when I write songs that I have a lot more creative space. As a matter of act, on my new album I have little sections in songs where everything will just drop out and it will be a totally different sound section."

**Synapse:** "Has the acquisition of these new instruments created new problems that have to be solved in order to get your performances to work?"

**Wright:** "Yeah, you need to have someone around other than the player. In other words, each player has his own road manager that knows the settings for each song and at the end of each song, he's right there switching everything around for the next song because in order to play and do that yourself, it would take too much time. We're trying to simplify things as much as we can. For instance, having a programmer built into the Oberheim so rather than having to switch all the dials yourself, you just hit a button and you've got the next sound."

**Synapse:** "What sort of performance set-up do you use to pull this off? How many instruments will be on stage?"

**Wright:** "Probably about 10 or 11 keyboards and there're three keyboard players other than myself, a drummer and two back-up singers." 

# POP GOES THE SYNTHESIZER

by JEFF JANNING

Modern recording and today's electronic technology are intertwined and really quite inseparable, much like life and taxes. This current phenomenon started in the 50's with the advent of a pop/country/blues hybrid "Rock'n'Roll." However, the highbrows of the day called this form of music everything from degenerate noise to bastardized music, and that's being kind. There are still many people who have not turned on to this art form even in its current state, which is far removed from its humble beginning. These people, unfortunately, listen with their predetermined prejudice rather than with their ears. This is most unfortunate as they merely rob themselves of one of life's greatest pleasures.

The growth of the electronic art form came from accidents and experiments in the recording studio. Echo was one of the first effects to come to the attention of the public. One can easily pick out the resounding ring on early Sun Records recordings of Elvis, Jerry Lee Lewis, and Johnny Cash. The next phenomenon came in the form of an accident on a recording called "The Big Hurt." Somewhere in the process of transferring the recorded signal, the two tape machines were running at slightly different speeds causing a wind-like sound which is now commonly referred to as flanging. These studio sounds along with stage electronics (which were confined to the electric guitar, the organ, and a few signal processing devices on early amps like reverb and tremolo) pioneered the path for today's synthesizers and various sophisticated electronic hardware for both stage and studio use.

The growth of synthesized sound came as recording studios created effects on records that recording artists wanted to duplicate in their live stage appearance. The race was on and the winner was the listening audience who enjoyed a million dollars in electronics for the price of an album.

Today, most of these effects: echo, reverb, sirens, wind, surf, tremolo, vibrato, wah-wah, pitch bending,

modulation, glide, plus the more standard sounds of various horns, strings, and keyboards are virtually at the fingertips of any musician who invests in a synthesizer. You will find a wealth of examples of the synthesizer's usage in new LPs released monthly by record companies. I have chosen the following albums to demonstrate a variety of applications in various diverse contemporary musical forms.

Disco/Soul music served up a large helping of synthesizer on Donna Summer's "A Love Trilogy" (Oasis Records OCLP5004). On side two is "Prelude To Love" the synthesizer plays a secondary role as it almost growls out a low pitched wah-wah effect in the song's instrumental introduction. On "Wasted" there is a good example of a string synthesizer being used to fatten the live string section. The string sound is well blended as the two entities are carefully mixed, but a close listen will offer a slightly cool sound that a synthetic string section often has. There is also a very well defined growl hovering just below the surface on "Come With Me."

---

## The growth of synthesized sound came as recording studios created effects on records that artists wanted to duplicate in their live stage appearances.

---

English Rock has been one of the more progressive musical forms, as the British record industry seems to anticipate new directions with a more understanding attitude than does its American counterpart. After all, Hendrix had to go to England to be discovered in America.

Styx new LP "Crystal Ball" (A&M Records SP-4604) offers a direct sampling of the synthesizer, as keyboard player Dennis DeYoung is very frontal in his application. There is no mistaking the intro on "Put Me On" as a synthesized passage. The apparent "horns" on the

cut are more electronic keyboards. The giveaway is a little vibrato that DeYoung throws in for good measure. "Jennifer" has a touch of keyboard strings that can be easily detected in the last few bars of the cut. The title track "Crystal Ball" offers a great touch of synthesizer on an extended solo after the first chorus. The ending passage of "This Old Man" on side two incorporates the wind effect leading into the next song.

Use of the synthesizer in Jazz has also come to full front. Chick Corea has used electronic keyboards to enhance his creative level. "Romantic Warrior," his latest album, (Columbia Records PC 34070) is filled with tasty electronic embellishments that explode, as in "Medieval Overture" or cascade like a soothing stream in "Sorcerer." Chick Corea uses a straight ahead approach and does not delegate the synthesizer to a secondary role in any way. On the other hand, "Karma" on the "Celebration" LP (A&M Records SP 713) places the synthesizer into a secondary coloring position. The tendency is to punctuate the standard line up of instruments rather than take the electronic leads.

Major breakthroughs have come in the classical field as well, where the synthesizer has awakened a new interest in an old art form. The new awareness started with "Switched On Bach" by Walter Carlos; a classical album comprised entirely of synthesizers. Another classical musician, Japan's Isao Tomita has an unequalled musical fluency. You will forget you are listening to synthesizers.

The next major step for electronic music is the recent breakthrough of the polyphonic keyboard. New technology keeps expanding the musical field, pushing previous barriers into oblivion. What used to be found only in the environment of the recording studio is within the grasp of all who reach for it. What will tomorrow bring with the recent advances brought by the new IC chips?

I'll bet when you get to heaven, Angel Gabriel will have forsaken his horn for a fully polyphonic . . . 

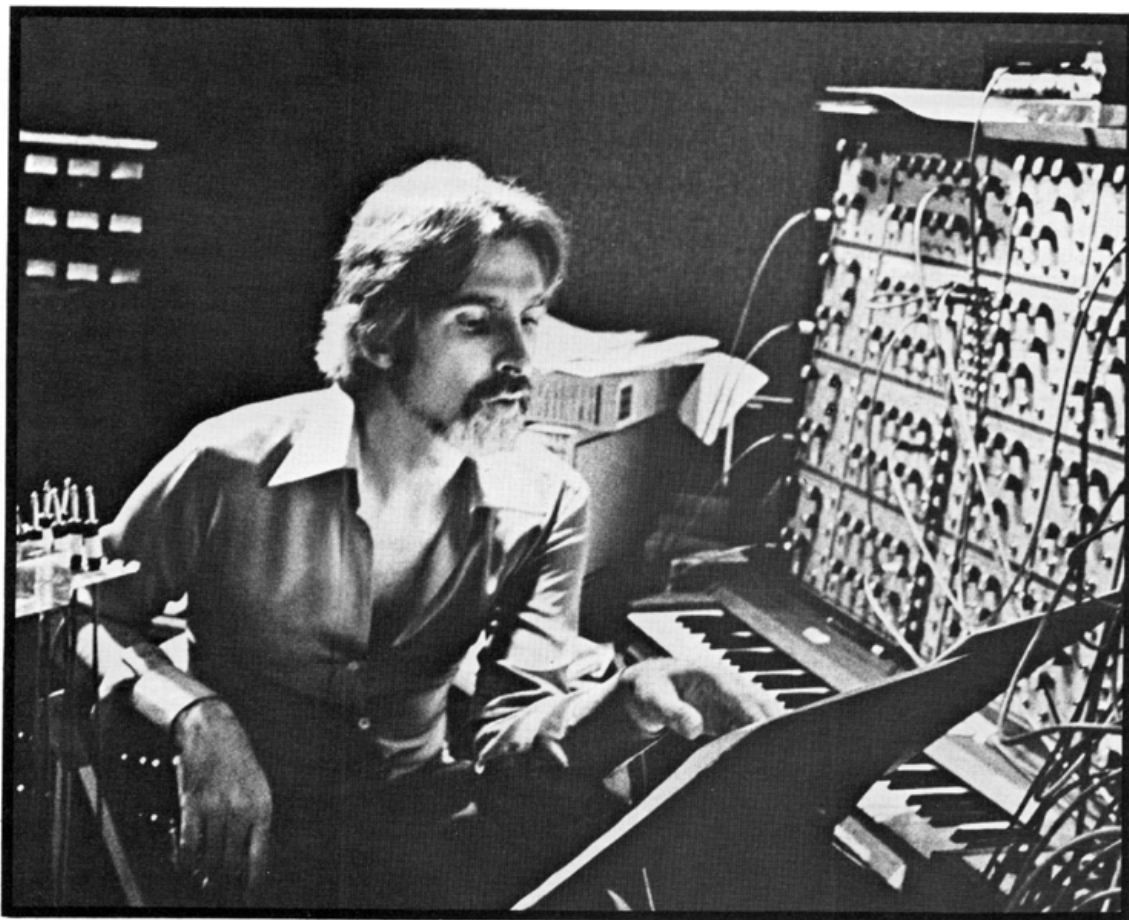

---

# Pat Gleeson

---

Pat Gleeson is a dedicated man. As if directing Different Fur Music, his San Francisco recording studio isn't enough, he also actively produces, programs and performs. His credits include performing on two Herbie Hancock albums, "Head Hunter" and "Crossing," and touring in Hancock's group. Gleeson has recorded with Lenny White, Freddy Hubbard and Julian Priester among others.

Gleeson's first album, "Beyond the Sun," an electronic portrait of Holst's "The Planets," represents an ambitious project exhibiting great discipline and restraint in interpretation.

---

---

# Pat

---

by Danny Sofer and Doug Lynner

---

**Doug Lynner:** "How did you get started in Electronic Music?"

**Pat Gleeson:** "That's usually an interesting question because we all came to it in weird ways. I was an amateur pianist and an English professor. I went down to Mexico in 1963 to visit my ex-wife and she said, 'There are some people I want you to meet.' When I asked what they were into, she said they were using a new drug called lysergic acid diethylamide. That was the beginning. From that, I found out two things; one was that I was 'okay,' and secondly, that everything has to do with music. Later on, I went to the audio-visual library and took out three tape recorders and started taping fountains, lawn mowers and so on.

"By this time, it was 1965. I remember I was living in an A-frame and I had all these pieces of tape hanging loose from the side of the wall. I loved it. I was immersed in all this sound. At that time if you had anything at all to say, you could gather three or four hundred people to hear it. It's not at all like today. So I started giving these concerts and people came. It wasn't just the music; it was pretty primitive and uninformed, but people were very responsive because we were all coming from the same place. We were all trying to recreate this acid experience. It was the early days of Scotch splicing tape and I finally threw the stuff away because all the splices were oozing apart. From then on I think my career became a little more conventional. In '68 I stopped teaching college and I started doing a few little sessions."

**Lynner:** "Were you using synthesizers at that point?"

**Gleeson:** "Yeah, what I did was I added to a small system another \$5,000 and a cat and I went together; he had tape recorders."

**Danny Sofer:** "Was that Moog modular equipment?"

**Gleeson:** "Yes, I used that until I went with Herbie (Hancock) in 1970. Then I used a 2600 because I couldn't use the Moog on stage. It was too big and cranky; everytime we transported it, we would have to pull a module out and I knew I couldn't do that on the road, so I started using ARP's."

**Lynner:** "When did you get your EMu system?"

**Gleeson:** "They came to me before they had actually built a production unit and in fact, I was selling ARP then. They came in right in the middle of an ARP 2600 sale announcing that the 2600 was a piece of crap and that they had something which was much better. But they were right, not that the 2600 was a piece of crap but that they had something that was much better. I didn't believe these guys but then I went down and I looked and just by the boxes and face panels I could see where they were at. I played it a while and placed my order.

That was in late '74 but it wasn't until the middle of '75 before I stopped using the 2600 for studio dates. Then what happened was I started using the EMu. It's so complicated compared to the 2600 that I began to get a negative feedback from producers about how long it was taking me to get the program together. As a result of that I've changed the way I do things. I don't do it by the session hour at all anymore. I do it for a \$1,000 a day. I work my ass off as long as they want me to but I tell them, 'Look man, I'm not going to rush.' That doesn't stop people from pressuring me but it makes them feel a little less like they've

---

**I think you get to a certain point in your life and you say now is the time to make what I'm going to make because I can't prepare to make it anymore.**

---

got to get it all out in one hour or three hours."

**Lynner:** "Were you with Different Fur Music by the time you got your EMu?"

**Gleeson:** "Yeah, well that existed in some way or the other all the time I was on the road. John just took it over and ran it for me."

**Sofer:** "Where did it really start?"

**Gleeson:** "It started in John's house; we had a multiple two-track studio and the control room was literally a walk-in closet. The control room window was a hole we cut between the closet and the living room which John hung a picture over so the landlord wouldn't notice that we had put a window in a closet. Then we moved into the warehouse in 1970."

**Lynner:** "Has the synthesizer ability

and equipment you have always been a big part of the studio? Is it a major thing that people came in for?"

**Gleeson:** "No, not so much in the sense that people came to use the studio for that purpose. What it's really been is my doing that has made the money to take the studio from stage to stage. I've been producing more and more seriously over the last two years so now I'm getting to the point that my income is pretty good from producing.

"It's funny, I've come to this point with the EMu where I realize what I've got is an analog instrument with some digital help. I'm falling out of date but I'm really content with it. I think that's where I'm going to stay. Maybe get more and more help from digital stuff but stay with analog instruments. I might have to change my mind, but the way I feel now it's taken me so many years to find out what I know about these instruments. Now I've got this vocabulary and I just want to use it. I don't feel like experimenting as much as I did. I feel more like realizing all the ideas that I have. I think you get to a certain point in your life and you say now is the time to make what I'm going to make because I can't prepare to make it anymore. I've seen other artists do that where they've been very Avant-Garde to a certain point and then they just lock in. When I was younger I thought of it as some kind of loss of something but now I don't think it is. It's just a change, and you almost have to, I think, if you're going to really develop what you've worked on. You just can't keep expanding the parameters of interest."

**Lynner:** "Did the work you did on *The Planets* suggest any further digital developments you could make to help facilitate the use of so many lines happening simultaneously?"

**Gleeson:** "Well, two things have happened. EMu has come out with a new keyboard which I am going to get."

**Sofer:** "The one with the micro-processor?"

**Gleeson:** "Yes. So that's going to get me into some new areas because that's 16 tracks digital."

**Sofer:** "That will remember 16 voice simultaneously?"

**Gleeson:** "Uh huh. I'm not clear yet about how I'm going to lock it to the click track but I know I'll find a way."

**Sofer:** "I was told that it was going to be real time like the synthi keyboard (EMS AKS) in the sense that you just play the notes and press play and it gives it back to you."

**Gleeson:** "Yeah, but because it's an



EMu product I'm sure it will be possible. The other thing is that after finishing *The Planets*, the logical next thing for me to do in terms of a record deal would be *The Rite of Spring*. The reason I did *The Planets* was that I knew it would be a popular piece but also because it's easier to perform than *The Rite of Spring*. I thought, well this would be the undergraduate course and *Rite of Spring* would be the graduate course but I now feel like dropping out. I think I want to do something now which is more involved

That means a common fugue is just a matter of displacing it some number of addresses or positions downstream."

**Sofer:** "Or reading the same memory with several different clocks."

**Lynner:** "It sounds like a Serial approach."

**Gleeson:** "What I want to do with it is a little different than Serial music. I want to make commercial music. By commercial I don't mean pop music, but I do want to make something a lot of people can hear. I'm very frank about that in my own mind and with other people. For the first time

in some other direction, that would be exactly what I wanted to do. I'm sort of free to choose, I feel and I want to choose the options that are going to work for me financially and in terms of a career. In terms of the whole record market, I'm still way out in left field anyway."

**Sofer:** "Does your relationship with Mercury Records allow you to put anything you want to do within reason or are you really limited to put out certain kinds of music?"

**Gleeson:** "I'll find out when Irwin Steinberg says 'no.' He's the president of

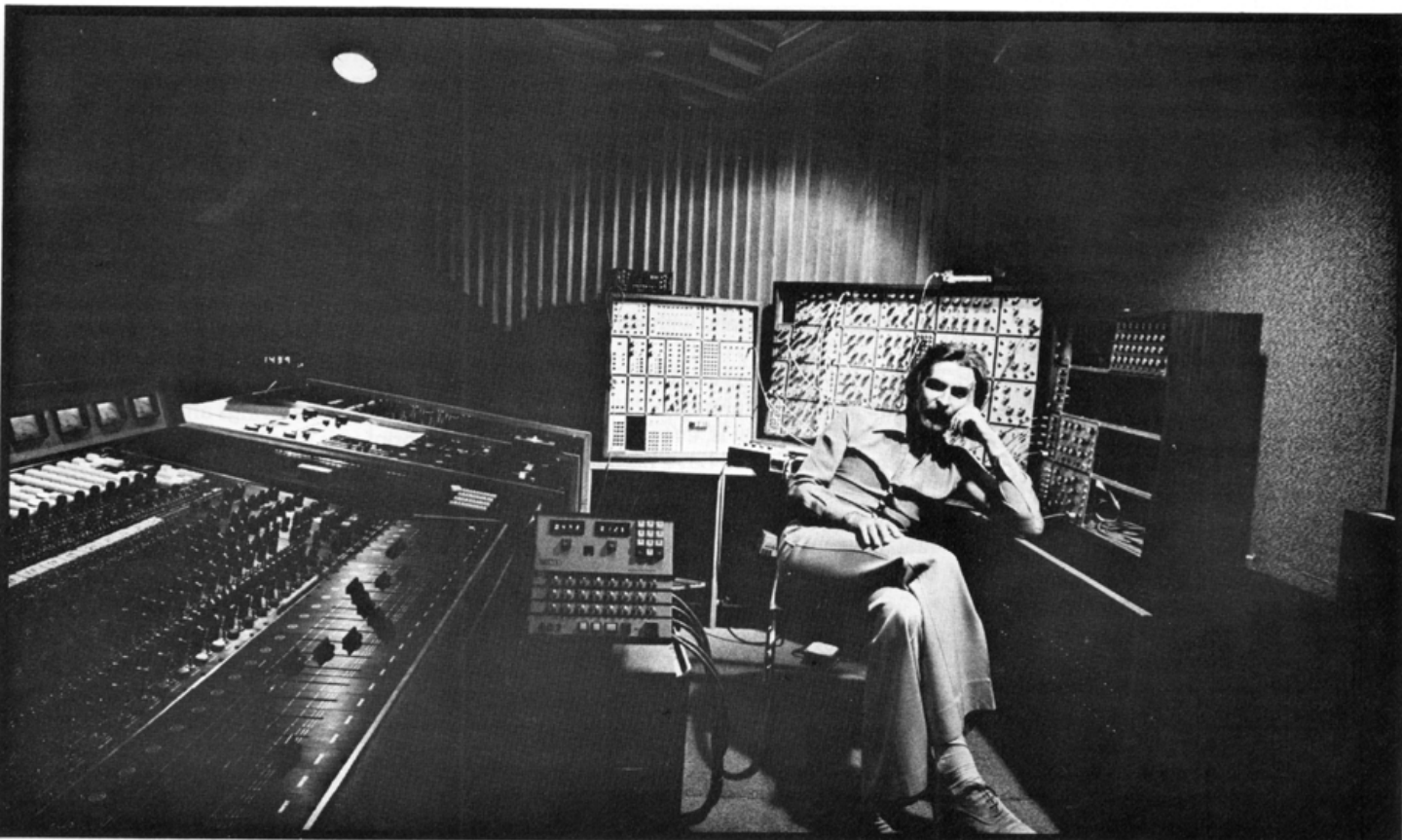

VIRGINIA QUESADA

"You know when I started the piece, I think I was trying to make a much more astral sounding piece than I did . . . I feel pretty certain that what I was first going to do, and what I'm sure Tomita will certainly do, really is a mistake."

with the sequencer as a compositional device."

**Lynner:** "In what sense?"

**Gleeson:** "Well, I'll give you an example. Let's say you drive the programmer with a clock. In effect, you've created a pseudo-Oberheim device which is on-going, and you tell it to stop when it gets to 512, which is the end of one memory. Then you load a pattern in that. Okay, now you put that down with the original click track. Now you've got a constant time base for whatever you do from here on and you've also got those outputs loaded into the memory, so now you can shift the memory downstream as far as you want.

in my life I've gotten my own work activity down to a point where I'm either arranging, producing, composing or performing and that's great; I love it. I don't want to screw it up. I want to keep having a record contract with a major label and there are certain things that that means. What I'm doing might be so commercial to some of your readers that they might not even be able to relate to it, but the price you pay for having this theoretical integrity is much more devastating to me personally, that is: you don't get to make music.

"Any music you get close to, you love. I love the kind of music I'm making; it's just exactly what I want to do and if I went

Phonogram/Mercury. I think the next album I do after this one I could name any project and they would accept it because this time I've demonstrated that what I'm coming up with is something they can market. But if I came out with a new one that was awful and didn't sell, then I think they would want to talk about it or maybe wouldn't want to talk to me ever again and just drop me. It would depend upon how many royalties I've accumulated."

**Lynner:** "When you started getting the contract together with Mercury, was there any amount of rationalization you had to do in terms of marketing your idea? Did they see the potential on their own or

did you have to lead them down the road of potentials?"

**Gleeson:** "It was funny; after years of fearing going to a record company with what I wanted to do and not doing it, I sat down and recorded *Mars* and on the basis of *Mars* I sent the tape out to five major labels. Four of them called my lawyer within a week saying 'We want it, let's talk about it.' The fifth label turned me down. Clive Davis turned me down and he sent me a nice letter, he liked it, he thought it proved me competent as a musician but for him, it didn't reach him emotionally and he always went on the basis of what his gut feeling was about something. He was turning it down not as a judgment of it but simply because it didn't reach him. I can respect that. How else can he decide?"

"The reason I went with Mercury was that I already had a working relationship with them because I was producing for them and I thought they'd be more interested in me because I'd already made them some money. At that same time I learned Tomita was coming out with *The Planets*, too, so it was a good thing I did it."

**Lynner:** "On the record liner notes that Walter Carlos wrote, he brought out what he believed to be one of the basic differences between the work you're doing and the work that he's doing, that is, that he plays everything from a keyboard and overdubs it whereas you stored everything except the first thirty some bars."

**Gleeson:** "The first 39 bars are done entirely by hand, then later, because it is still much more difficult and time consuming to program. When Mercury pushed the deadline up, I began to play more things by hand, but certainly a substantial part of the album is programmed."

**Lynner:** "You also said that the new keyboard you'll be getting, the micro-computer, is actually programmed by playing the keyboard. Is that breaking down what Walter Carlos said is the difference?"

**Gleeson:** "Maybe, for me the purpose of putting stuff in storage is that pitch and timing information within certain limits are not subjective. If it's F sharp that's what it is, you can't play a G. It's not as if one performance is going to be more F sharp than another one. It is what it is. When you're dealing with orchestral works, while there is this whole thing about interpretation, that takes place (I guess for Carlos, too) with the click track or the first track you lay down however you lay it down. The way I work is that I

set up a clock which is driven by the keyboard and I have the keyboard voltage sharply attenuated so that I only get maybe a 5 per cent or 10 per cent difference in the clock rate and if I have to make a real sudden jump on tempo, I'd probably splice it on the two track. So after you've decided on an interpretation of the work, tempo as well as pitch is really no longer subjective. What I want to do is get all of that out of the way so I can concentrate on the performance aspects."

**Sofer:** "So you spend your energy during performance, manipulating all the

---

## I created a resonance cavity that imitated her resonance cavity.

---

other parameters other than pitch and duration."

**Gleeson:** "Right. And you'll notice that there's a lot of changes in dynamics that I don't associate usually with synthesizers and that's how I do that."

**Lynner:** "It seems like there would still be one level of difference between the two of you and that is, even though Walter Carlos would have his basic track that is used as a reference from then on out, the articulation of each beat has a real different feel. Obviously with it programmed, there is not going to be one line slightly before or after another. Everything is going to be right on. The articulation is just uncanny. Do you think that that's an advantage, a disadvantage or a nebulous point?"

**Gleeson:** "I don't know. It just is. The fact that you can do that is interesting. There's another thing about it which is wonderful and that is, consider first that the click is very fast, in the range of about 30 to 50 Hz. and suppose the tape machine may have a dropout. One time through it will catch the pulse and the next time it won't. So even though this whole thing is lined up like clockwork, as I would do several string tracks, this richness would build up that had also to do with very slight variations in timing. There is still the factor of error that is useful."

**Sofer:** "Dave Luce, when talking about simulating instruments, said certain notes are going to have a higher voltage applied to the VCF than other notes. Were you doing these functions manually or programmed?"

**Gleeson:** "I almost always did those manually. I tried to program every parameter I could program at least once.

Sometimes it works, sometimes it's better not to. It's so hard to say what the feeling difference is going to be between a one-fourth octave change in voltage applied to a filter as opposed to just twisting the knob. I think there's an area where analog equipment is ahead. It's a direct human interface. If the changes are so abrupt that you don't do them by hand, you have to program them. That's what I used in Mercury. In Mercury, most of the time, I'm not programming filter point. I'm programming loudness and attack. There's some great changes that you really couldn't play. It's a funny thing about that piece. I sped it up quite a bit from where any orchestra has played it but it sounds to me much less hasty."

**Lynner:** "Nobody's scrambling for the notes."

**Gleeson:** "Jesus, that's it; that is an incredible piece to hand to an orchestra; I mean those guys must have shit the first time they saw that and found out what the tempo was!"

**Lynner:** "I have a few more questions that have to do with how you realized the piece technically. One of them is the waveforms you chose for certain instruments like strings and horns. In the pre-print you mentioned Chowning saying that a square wave with this duty-cycle and this harmonic content is best, but everybody is using a sawtooth (strings) and I've seen lots of other people vary in the direction they approached it from. How did you decide? Did you use any sort of waveform analysis of instruments to create the waveform or was it by ear?"

**Gleeson:** "I have taken specimens of instruments and looked at them on the scope but unless you've got a storage scope, there's hardly any use. What does make a lot of sense is to see what are the relative amplitudes above the fundamental.

"What I did do on the last piece is that I had a woman soprano come in and I had her sing one of the parts. I've done voices before which were pretty realistic but I wanted to get some quality of the human voice that wasn't there before. So I had this woman come in and sing the part, then I played those notes as I made numerous adjustments. Then I took her voice and ran it through a series of three resonant filters and I turned the Q up pretty far and I swept until I found the three freakiest points of resonance. Then I made a guess in terms of amplitude about what the difference was, turned the Q back down to that point, got rid of her voice, now took the voice that imitated  
**TURN TO PAGE 35**

# Touch Responsive Keyboard

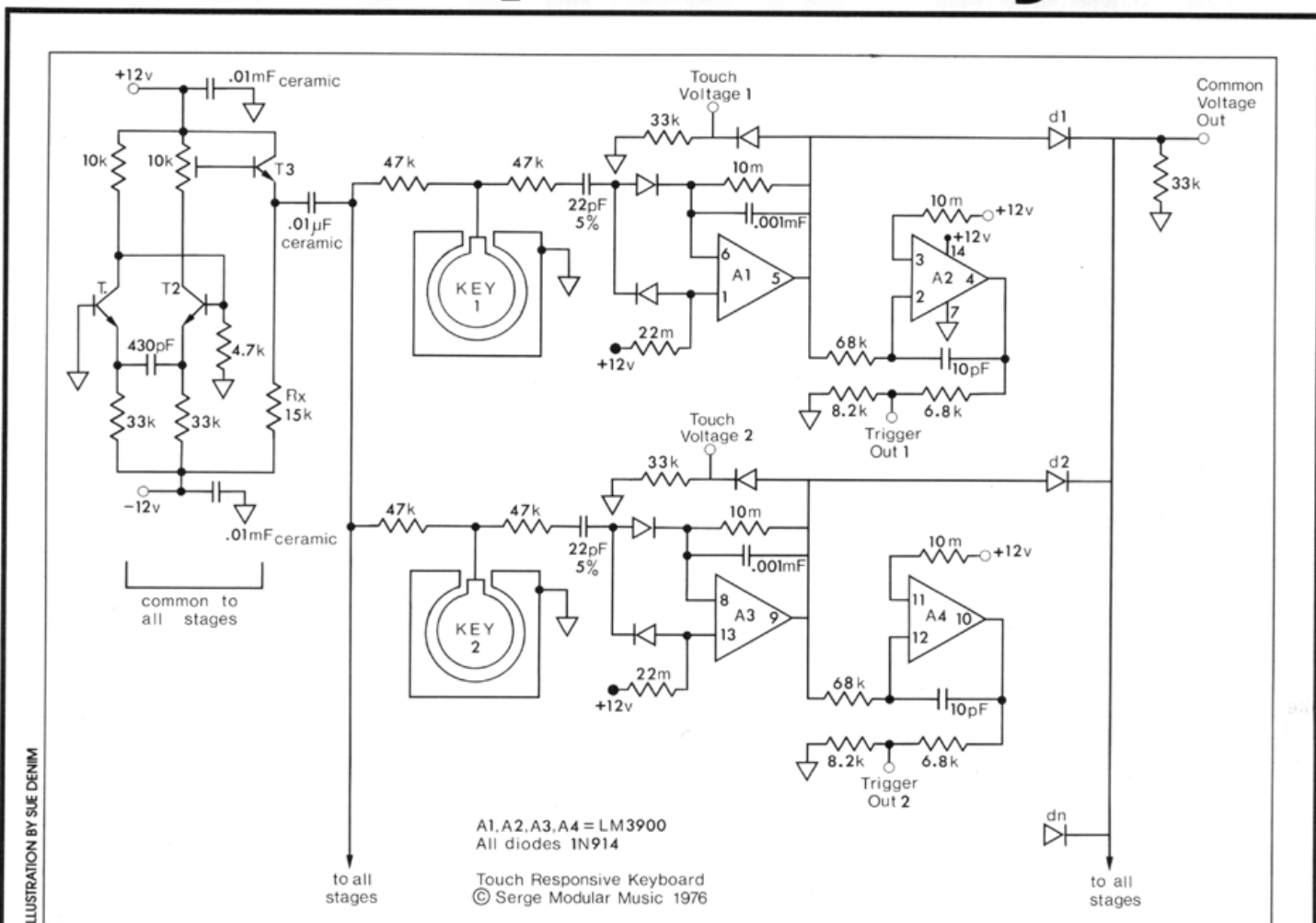

ILLUSTRATION BY SUE DENIM

## Construction Of A Touch Responsive Keyboard

by Arpad Benares

This keyboard may be made with as many keys as you like, though the value of Rx (now 15 K) may have to be made smaller as more keys are added. Each key provides for touch proportional voltage and pulse outputs. The pulse output stays *high* for however long the key is touched. In the schematic, the stages' touch voltages are combined through the diode selector network composed of D1, D2 . . . DN; resulting in an output dominated by whichever key is touched hardest. This function is optional, but is useful if you wish to use the keyboard (in conjunction with Programmers) to play melodies with touch control of their dynamics. The keyboard may be built and installed to fit any flat surface, for example, the

body of an electric guitar. Make sure that all components are mounted in close quarters with the touch keys. Wiring should be kept tight. The touch keys will preferably be etched on a suitable p.c. board, and sprayed with a thin coat of spray-on polyurethane or acrylic. Note that the pattern surrounding each key should be grounded.

Connecting your touch responsive keyboard with a Programmer (whose construction will be described in the next issue) will result in an exceptionally powerful unit, able to access as many presets as you want at a touch. This means too, that your keyboard will be able to perform non-tempered scales, since each of the keys can be preset to a different tuning.

Troubleshooting this circuit is relatively straightforward. T1, T2 & T3

make up an emitter coupled astable oscillator with a somewhat distorted square wave output of about 100 kc. The 10K trimmer shown should be adjusted for zero pulse and voltage outputs at zero touch for all keys. The first amplifier (A1 for key 1; A3 for key 2) for each of the two stages shown is a full-wave rectifier and filter whose output goes positive as more of the 100 kc is shunted to ground by touching a key. The second amplifiers (A2 and A4) provide pulse outputs. The circuit may be operated with + and - 12 or 15 Volt supplies.

A very similar touch responsive keyboard using a piezo-resistive and not a capacitance principle, and featuring a built-in Programmer-sequence function, is available from *Serge Modular Music*. 

# GUERRILLA ELECTRONICS

by Bob Davis

## MORE MONKEY BUSINESS

In electronic music there are relatively recent phenomena which allow musicians and other non-specialists to build their own electronic devices. This has happened because of the technology of IC's or integrated circuits. Each circuit, also called a chip, houses 100's or 1,000's of virtually microscopic components which would have been used to construct the traditional circuit. It replaces diodes, transistors, tubes, you name it. This also reduces the number of mistakes possible though it by no means eliminates them.

A movement among composers which some trace back to David Tudor and Gordon Mumma has begun. In the last issue of *Synapse* several composers, David Behrman, Paul Demarinis, and Anthony J. Gnazzo, each told something of their devices, performances, and opinions having to do with guerilla electronics. This article will continue the discussion with other composers and report on the workshop and concert held at the Center for Contemporary Music at

Mills College on Sunday, October 24, 1976.

John Adams teaches composition analysis, and directs the New Music Ensemble at The San Francisco Conservatory of Music. About three years ago he realized that there was a need for a synthesizer which was specifically suited for use in performances and with instruments or microphones. Previously it had been necessary to use the Buchla synthesizer and its hybrid addendum which was housed in the school's electronic music studio. The additional modules were built and sometimes designed by the studio's director, Alden Jenks. This "Buchla et al" synthesizer would perform admirably in concerts and has been used for pieces of Alden's as well as Alvin Curran, Guillaume De-Machaut, and Ivan Tcherepnin. However, using it meant disemboweling the electronic music studio for several days and besides, this synthesizer wasn't really built for moving around. It resented it and would have tantrums.

Perhaps this is what prompted John to build a general multi-purpose device. One that would be suited to performing the works of a wide range of composers. He said its "not a progressive piece of equipment in terms of having specialized devices." The result is more like a "traditional" synthesizer than many guerilla projects.

The Studebaker, as the finished device is affectionately called, has 9 oscillators each of which provides 5 different wave shapes; 4 filters, 6 pre-amps for microphone or other outside signals; 5 envelope followers; 5 comparitors; and various gates, sample and hold and the like. It's also very compact using only mini-potentiometers and mini-lugs which are also called 1/8" phone plugs. This saves space, but John says that when a full patch is being run, "I almost can't get my hand in."

John began his project of the Studebaker with "zero" background in electronics. First he read basic books in electronics. When he encountered the



A MAN AND HIS I.C.



AN L.E.D. PARTY

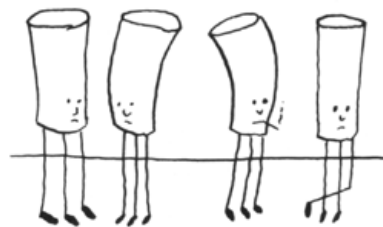

UNEMPLOYED TRANSISTORS

CARTOONS COPYRIGHT © 1977 BY RICH GOLD/.

equations used in these books he decided that he needed more background in math. So he spent about a year studying trigonometry and calculus. "It turns out that I didn't need to know all that, but I don't begrudge the time I spent." That time working with abstract mathematics became "a very mystical thing" which culminated in *Groundings*, the first piece performed on the Studebaker.

"*Groundings* is a routine electrical procedure. The term also suggests a spiritual metaphor. As an activity for performers *Groundings* is comprised of a number of smaller piece-games or 'modules' for singing, speaking, playing (an instrument) and manipulating home-made electronic circuits. Most of these smaller pieces can be performed separately." Some of the sections are entitled: Ceremony of Counting, Spectral Bands, Strident Bands, Critical Bands, High Q, Corssings, and Schedules of Discharging Capacitors.

"Schedules of Discharging Capacitors" asks the performers (3) to manipulate the pitch of an oscillator and the range of a band pass filter according to a score. The oscillator has two alligator clips extending from it. The kind of oscillator attached to these clips changes the pitch of the oscillator. (For those who aren't sure: for the purpose of this piece, a capacitor can be explained as something which holds an electrical charge up to a point and then lets it all go.) If one kind of capacitor is used it discharges every half second and the audience hears a clicking at each discharge. If it discharges 60 times a second the sound produced is a 60Hz (or 60cps or 60 cycle) hum. The filter altered the timbre of the sound from a thud to a high whine.

Another modular movement is "Crossings." This takes the microphones from three male singers and runs them into separate comparitors. The voltages from the comparitors are then used to control the pitch of a low frequency



RIDING THE  
WILD RESISTOR



## MUSIC

oscillator. The voltage inputs of the oscillator are summed so that two voices will push the frequency higher than one. Besides going to the comparitor the voices are also mixed and sent into a voltage controlled gate. This gate is controlled by the oscillator. Therefore the more people singing the higher the pitch of the oscillator and the faster the gate will open and close.

The Studebaker has served its function well. John has used it for other pieces; Triggering, Studebaker Love Music, and Onxy. It was even used as a kind of rock 'n' roll/jazz keyboard instrument for a piece of David Rosenbloom's. However, John would not undertake such a project again. Perhaps it saves money on hardware, but the time it takes building, checking, and rebuilding all but cancels this financial advantage. "It's much more valuable for me to spend my time with aesthetic considerations and find a better trained person when there's equipment to be built. "I've read that Stockhausen designs his own equipment, but that's not true. What he does is describe the concept of a particular device, say a mixer, to an engineer. The engineer then does the

Phil Loarie's Digital Dronozilla prototype.

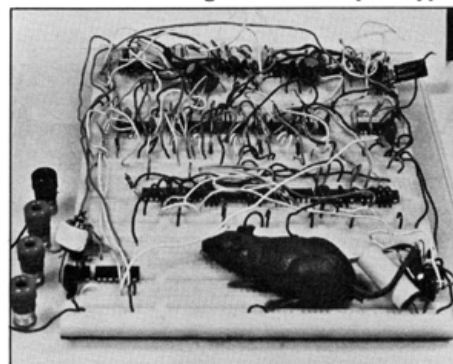

PHOTOGRAPHS BY VIRGINIA QUESADA

actual schematic and solder work."

John said that after doing all the reading he didn't have a good idea of how to go about building. He found he needed more "empirical" knowledge. That means getting your fingers burned with solder and frying a few IC's with too much heat from the iron. It means becoming an "electrician." Everyone has to do this when they being building. It's a frustrating part of the process, but unavoidable. John might be found building a particular device that he finds a need for, but a whole "synthesizer?" Quote the Raven "Nevermore."

The Center for Contemporary Music at Mills College is somewhat of a hot-bed of guerilla activity. As a part of the recent "First Annual Festival of New Music sponsored by Music/West: A Consortium of Contemporary Performing Groups in the West," the Center sponsored a Sunday afternoon workshop devoted to guerilla electronics with a concert that evening. The concert, though it was not exclusively of music that used home-made devices, featured several of the devices used in the workshop.

The format of the workshop was very informal. There was a kind of science fair atmosphere at this afternoon event planned and presided over by Bob Gonsalves and Phil Loarie. They had prepared a nine page booklet which included recommended readings, a glossary of electronic symbols, and eleven schematics. Some of these circuits were: "4 in/1 out line level mixer" powered by a 9 volt battery with a total cost of under \$5.00; "pseudo random data generator" which repeats itself after 8,589,934,591 voltage events for about \$3.00; "voltage controlled amplifier" at 25 cents per input. I could go on, but this begins to sound like an ad for a flea market. One note, however, is the warning which goes with these and all other schematics, "The authors are not accountable for any damages inflicted

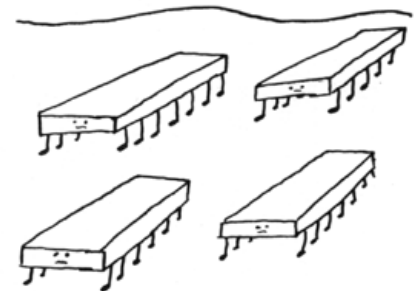

NIGHTMARES

upon one's soul or mind, body or spirit during an attempt to deal with these circuits."

People mostly looked at books which were left lying around and asked questions about the devices they saw in operation. Bob had hooked up a light sensitive trigger to a Tcherepnin synthesizer. The trigger would change state when someone put their hand over the light sensitive element. It had two states, low and high, and could stay in either one for an indefinite length of time. When one wiggled their hand over the light sensor the sound would go off and on in response to the electronic pulses caused by the lack of light. If you left your hand over the trigger the sound would just stay on and on and on.

There was also a circuit for producing drones which features control via a calculator keyboard. This device of Bob's had an oscillator tuned to about 100 Hz. The calculator provided a "multiplying factor" which would change this frequency to up to 25,000 Hz. (which is about 5,000 Hz above the human ear's range.) This also went through a ring modulator.

Doodahzilla, one of Phil's babies, was also wailing away this afternoon. This device was discovered "while making some mistakes euphemistically called experiments, in logic programmed devices." It produces rhythm structures by simple division circuits. This idea is exactly in step with the way in which rhythms are notated in western music. After all, the relationships between the different note values (whole, half, quarter, and even triplets) are basically "simple."

Bob and Phil say that 85% of their parts were from old circuit boards which were usually from peripheral devices originally attached to computers. These old boards and such items are obtained from surplus dealers. This is a kind of "Salvation Army of Electronics." Often these are warehouse-style stores full of

## GORILLA ELECTRONICS



power supplies from planes, racing cars, junked calculators, boxes, scraps of plexiglass. Sometimes things are even sorted out. There are always stories of finding incredible buys like the printed circuit boards from a major synthesizer manufacturer's keyboard for \$8.00. But don't run out and start rummaging right now since there's a certain problem of recognizing the keyboard from surplus tank parts.

An unexpected event of the workshop was Mark Weider, who brought his home-made electric guitar synthesizer. This device features phase lock loops which will "track" an input signal's rises and falls. He also had a dividing chain which produced pitches one or two octaves or an octave and a fifth above the input of the guitar. There were also filters for altering the instrument's timbre and VCA's.

Now where exactly did these composers get their designs? They don't all have their personal engineer to ask for circuits. The companies who manufacture the IC's also print "data books" which contain information about and applications for their products. Besides

asking other composers or designers there are many periodicals. Few publications specialize in just electronic music (*Synapse Electro-Notes*), but there's much good material in others as well (*Popular Electronics*, *Radio Electronics*), and also in electronics trade magazines (like *Electronics* or *Electronics Design*).

That evening in the concert hall at Mills two pieces featuring guerilla electronic music systems were presented, appropriately enough by Bob Gonsalves and Phil Loaire. Phil presented the world premiere of "Space Rangers from Dronezilla." This piece features Phil playing his device Dronezilla. Don Cardoza played a Hohner Clavinet tuned in just intonation through a Countryman Phase Shifter. About them were seated four "Space Rangers." These people each held a fiberglass tube of about 3" in diameter and varying in length from 3' to 6'. Small speakers were placed inside one end of each tube with the other end left open. The result was that the bass presence of these 3" speakers was greatly enhanced. After about 2/3 of the piece the space rangers stood up and began whirling the tubes about. This gave the cascading sounds of Dronezilla the added dimension of doppler shift and amplitude modulation. Don on clavinet was improvising his raga line throughout Phil's skillful Dronezilla sounds.

Bob Gonsalves' piece is best described in the composer's own words. "The second guerilla of the evening began during the intermission with a 60 Hz drone. The line frequency drone was from a sawtooth wave passed through two Moog variable high-Q band pass filters and a tape delay using two Scully's and a Teac 3340 four channel machine. Superimposed on this was a teaching parable read straight forward, randomly, and in reverse. Thus the tale of Vishnu and his forgetful servant Narada was revealed in a non-linear (synchronous)

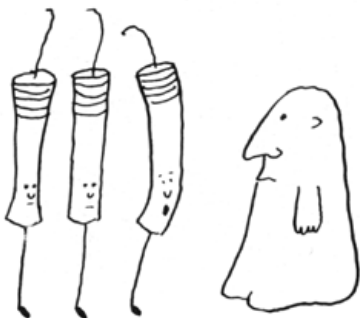

TOUGH RESISTORS SPELLING IT OUT

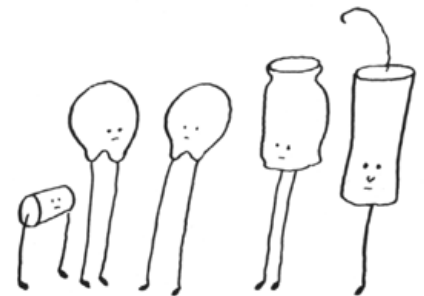
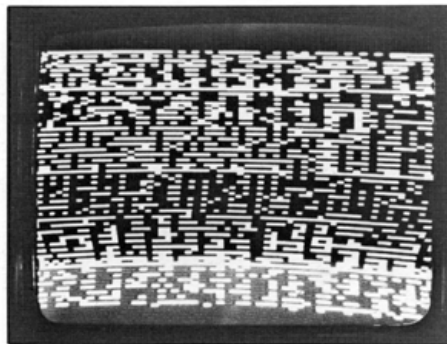

A CAPACITOR FAMILY

manner.

On stage Bob was typing on a computer-type keyboard, smoking Sherman's and drinking Mocha Cow. The microprocessor system used was an Altair 680 featuring the Motorola 6800 processor family. Interfaced on the output side of the computer was a latch and decoding circuit that could light up 1 out of 64 light emitting diodes which were arranged in a circular matrix. Various patterns, such as spirals, imploding and exploding circles, and rotating arms were displayed at varying speeds. The effect was similar to a dynamic mandala.

The psychic state of the performer paralleled that of the Saint Narada, who ran to get a glass of water for his Lord and forgetting his task, burned through a lifetime only to awaken by a riverside to find Vishnu simulating impatience. Bob would proceed to first light a cigarette and then take a drink. He would change some program variable and forget the whole sequence of events, muttering into a microphone all the while. By the end several mistakes were made and the computer would no longer respond to the utter confusion of the programmer/performer. The scene faded in darkness to Don Cardoza's thunder tape, realized on a Chamberlin type keyboard."

Guerilla electronics is a definite part of today's electronic music scene. It might provide exactly what composers not affiliated with schools need. That is cheap equipment. However, it might prove that the time and trial of solder and schematic even with the greatly simplified and accessible technology, will be too much for most. This article has proven two things 1) The technology is there and people are making use of it to do exciting and exploratory things, and 2) no one, even those who'll give you schematics to work with, will take the responsibility for your first mistakes and frustrations which lead to the great music. 

SECRET AFFAIR W. CAPACITOR

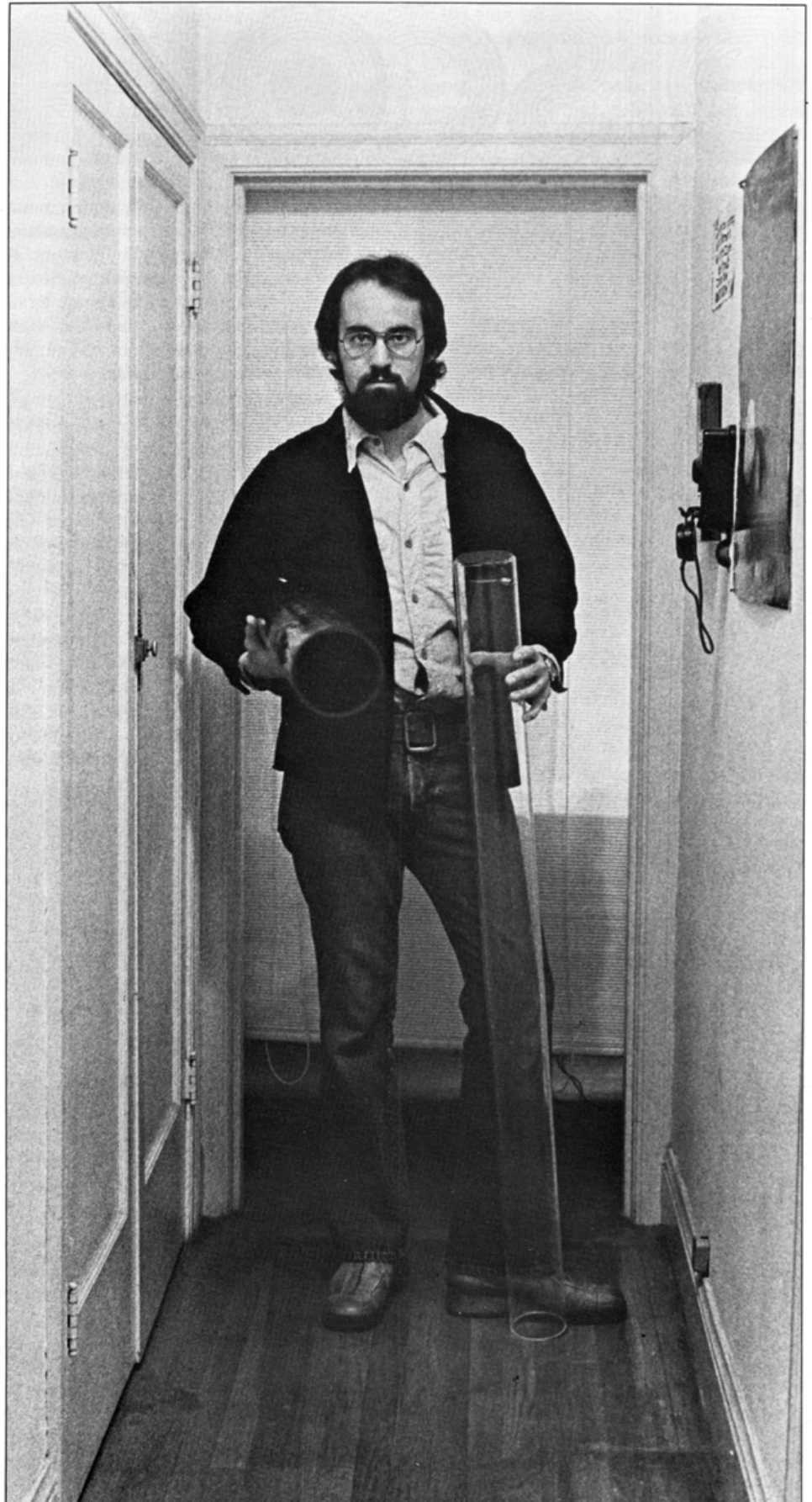
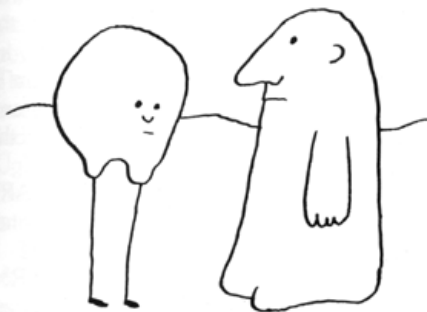

Phil Loarie

# DISCOOLA



**Tomita: The Planets**  
RCA Records

On the interpretative level, "The Planets" is Tomita's most tasteless recording to date. So who cares? Tomita does not pretend to be Herbert von Karajan, and the Holst warhorse is schlocky even in the original version anyway. As the world's most commercially attractive synthesist Tomita must satisfy not the symphony concert crowd, but the more jaded pop audience. He has obviously gone all out to surpass the flash of a famous orchestral showpiece. The result is arguably the most technically brilliant synthesizer recording ever made.

Tomita could not resist employing an "outer space" motif which occasionally (perhaps tongue-in-cheek) recalls the clichés of 50's science fiction flicks. The record commences with a corny rocket blast-off that segues into "Mars, the Bringer of War." On occasion he displays genuine wit, as when a prominent theme of that movement is heard as if over a spaceship radio, complete with crackles and static. Appropriately, the big funny occurs in "Jupiter, the Bringer of Jollity," when some irreverent, unearthly voices join in the solemn "Land of Hope and Glory" chorale.

Tomita's addition to the printed score, however, are most often serious. In fact, his masterly integration of the non-tempered sound events and special effects with the orchestral textures constitutes his principal charm. The synthesized orchestral timbres them-

selves are chosen with Tomita's usual skill to enhance the expressive qualities of the music. "Venus, the Bringer of Peace" is full of glistening harps, shimmers, and silvered sustains, while "Mars" is dominated by demonic brass rising from the depths of a quietly seething maelstrom in the bass.

The technical tour de force is undoubtedly "Mercury, the Winged Messenger." Those scintillating scales rush up and down with the fleetness and precision of an ICBM. Another miracle wrought is "Saturn, the Bringer of Old Age." The biggest bore of the orchestral suite. In Tomita's hands "Saturn" becomes almost like an avant-garde tape composition: the notes seem done away with, leaving only evocative sound images to carry the music. The final movement, "Neptune, the Mystic," is perhaps the most deftly realized. An aura of remoteness pervades this portrait of the planet then believed the most distant. For five minutes the music hangs in exquisite suspension before drifting off into ... space? (The movements are connected, by the way, by short electronic interludes composed by Tomita to provide a smooth transition of mood. These interludes are quite striking in their own right.)

There are a few disappointments. For some unfathomable reason Tomita chose not to realize the sixth section, "Uranus, the Magician." Instead, he gives us a ghostly ninety second collage of "Uranus" main motifs. This is novel but hardly satisfying. Another bummer is the extremely poor signal-to-noise ratio making it impossible to listen to this disc without enduring unpleasant amounts of hiss.

Comparison of Tomita with Walter Carlos can be enlightening because Carlos practically invented this entire "synthesizer-realization-of-old-classics" genre, not to mention the fact they both use Moog's modular system. Carlos' best-selling versions of music by Bach, whose work is characterized by rhythmic regularity and the "moto perpetuo," created an entire image of synthesizer music as "clockwork," repetitive, and sequenced. This image is pervasive today, especially in advertisements,

broadcasting logos, etc. Tomita, in choosing to realize the more expressive music of composers like Mussorgsky, Debussy, Stravinsky and Holst, completely rejects this image. By downplaying the obvious mechanics he shows the synthesizer to be as capable of sensitive nuance as any acoustic instrument or ensemble. He has "humanized" the soulless machine. While Carlos may have had the more serious artistic intent and won praise from such taste-making honchos as Glenn Gould, Tomita has left the esthetic of "Switched-On Bach" far behind. Whatever the final merit, he must be considered an artist in his own right.

— Tom Davey

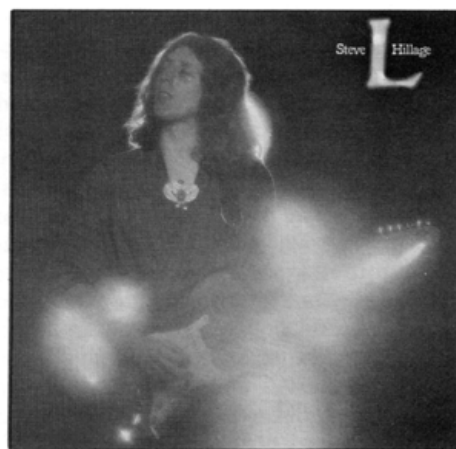

**Steve Hillage: L**  
Atlantic/Virgin SC 18205  
(Virgin UK V2066)

I have mixed feelings about this one. There's some things like "Lunar Musick Suite" that are pretty nice space rock with a twist here and there (a jazz trumpet solo in a galactic environment, for example); but some of it is awfully misguided.

"L" was produced and engineered by Todd Rundgren at his Woodstock, N.Y. studio, and features most of Utopia as well. I suspect that this was Rundgren's next project after his own album, "Faithful," of which half was devoted to the re-recording of his favorite songs of the sixties. This may explain the presence of "Hurdy Gurdy Man" and "It's All Too Much" on the album. However, except for an occasional lapse in taste, the album is magnificently produced; it's filtered and flanged sound is well suited to the material.

Hillage plays guitar as well as ARP and EMS synthesizers, sometimes interfacing the guitar with them. He is complimented by Roger Powell's RMI Keyboard Computer and Moog. There



is a gypsy-like quality to Hillage's runs, as well as the presence of tabla, Tibetan trumpet, and Tibetan bells; all of which added to the celestial use of the synthesizers and studio, results in a sound that the title of Hillage's song describes best: "Electrick Gypsies." A curiosity.

— Danny Sofer



**Brand X: "Unorthodox Behavior"**  
Sire Records

As everyone must know by now, Brand X is the British fusion band led by Phil Collins, the drummer and (since the departure of Peter Gabriel) lead singer for the art-rock band Genesis. he does no singing, however, on "Unorthodox Behavior," the debut Brand X album. Nor does he need to. His drumming and percussion, quite approaching the excellence of Billy Cobham, whose playing Collins' resembles, is the instrumental standout of the album. The other band members (John Goodsall, guitars; Percy Jones, basses; Robin Lumley, keyboards) are by no means bad. Collins simply dominates.

This state of affairs has an inherent drawback. Musical facelessness usually results when the drums are the focal point of a band. Almost any solo album by a (however excellent) rock drummer will prove this elementary point. Another identity problem plagues Brand X. They are that most unusual of hybrids, a "blue-eyed fusion" group. Which is to say, they are four white Europeans playing a style that is idiomatically black American. It is obvious they are not to the style born. They wisely shy away from the more overt stylistic trademarks of black music today. Only once (on the cut "Born Ugly") do they attempt funk jazz a la Herbie Hancock. The effort is labored and insincere.

The most apparent influence upon them is the semi-classical jazz-rock of Return To Forever. Sadly, Brand X

mostly suffers by the comparison. Where RTF is strongest — in production values and in imaginative use of the studio—Brand X is weakest. Not much bucks was sunk into this disc, it seems. There is so little apparent overdubbing on the album that most cuts sound like live arrangements. In particular, the synthesizer playing of Robin Lumley has some tasty pitch bending but timbrally is pedestrian. One suspects that this could be deliberate on the part of Brand X, if their instrumentation is any clue to their esthetic orientation they are as much an acoustic band as an electric.

Now for the good news. Unlike RFT, Brand X is not a group of soloists, each vying for attention. They are an integrated, cohesive ensemble. While Collins' playing is a notch above the rest, they all engage in instrumental dialogue in the true sense of the word. All of their tunes are well crafted and most are inspired. One of them, "Nuclear Burn," cooks rights along and is excellent by any standard. They have in fact done very well for a debut album. The potential can plainly be heard. What their music needs is more individuality and more assertiveness from guitar and keyboards, not to mention a larger recording budget.

— Tom Davey



**Vangelis: Albedo 0.39**  
RCA LPL1-5136

A breathtaking cover hides an album that shows the pitfalls of the individual composer/arranger/performer in the home studio.

Vangelis' approach is your basic Mike Oldfield, only more heavy handed, with a lot of drums, that are boomy and distorted. To my mind, they both suffer from the same problems of using a multitrack tape recorder with a click track; the consequence is that the tempo never changes, and the density of sound

stays about the same as well (The "need" to use all 24 tracks). There are changes in the dynamics (however, mostly f, ff, fff) but even when the apparent volume is softer, the actual level doesn't change much, resulting in the urge to turn it down, or off.

Vangelis' use of the synthesizers is rather good though and the spacy, free fall sections are evocative, especially the title track.

The album has a soundtrack quality to it that would be more interesting if there were more images to go with it. How about a videodisc?

— Danny Sofer



**"Unplayed By Human Hands"**  
Computer Humanities CR 9115

"Unplayed By Human Hands" is a recording of some classical music pieces performed upon a large pipe organ. The catch is, the performer is a computer. (The technical means of this remarkable feat are detailed by its creators elsewhere in these pages.) The reviewer is tempted to treat this disc as a novelty item, soon dismissed, rather than as serious music-making. One hearing alone suffices to resolve the question. The (momentarily) frightening fact is, the computer sounds like it commenced taking organ at age four and has been practicing six hours a day ever since. I defy the uninformed to detect merely by listening that a computer is playing the music on this recording.

Of course, a human being is playing the computer, via its programming. (The programmer's name is Prentiss Knowlton. He is a computer scientist at the Jet Propulsion Laboratory.) The relevant question therefore becomes: how good is the programming? In other words, the burden of excellence is shifted back to the human, where it has always been in music performance; the computer remains a passive tool, exactly like the organ itself. Purists therefore have no

logical esthetic grounds on which to quibble. (The difference between this situation and previous "computer music" is that here the computer performs upon a musical instrument rather than directly generating the musical tones itself.)

At the risk of pointing out the obvious, if there is a problem, it is the computer's very perfection. If one is listening for it, the tempos seem too unwavering; the notes of a chord are struck too simultaneously. Accelerandos and ritards are no problem to program of course, and they are on the recording. But what of rhythmic nuance at the level of the momentary? And what of that most indefinable characteristic of musical performance, spontaneity? Are these not phenomena whose very nature precludes pre-determination?

The esthetic can of worms first opened by the advent of tape music is back again. Theoreticians may argue endlessly, but no one will be surprised if it is technology itself that finally resolves these questions. It seems probable that more subtle programming can take care of the problems of articulation and nuance. (As noted elsewhere in this section, Tomita has encountered and conquered similar difficulties.) Doubtless the characteristics of spontaneity itself can be isolated and made programmable. At that point, it may not be the real thing, but no one will be able to tell the difference. Where it counts, at the aural level, live performance and programmed performance will have become indistinguishable.

For the record, the works performed on "Unplayed By Human Hands" are Rimsky Korsakov's "Flight of the Bumblebee"; Roger-Ducasse's "Pastorale in F"; Mozart's Overture to "The Marriage of Figaro"; Scott Joplin's "Maple Leaf Rag"; Bach's "Concerto in A Minor" (after Vivaldi) BWV 593, and Ives' "Variations on 'America.'" The works by Ives, Bach and Roger-Ducasse are the only ones written originally for the organ. They are easily the best, most ambitious performances. However, the Rimsky-Korsakov arrangement is delightful. The whole thing zips by in just a minute and 18 seconds. The Mozart is somewhat dispirited and suffers from a heavy-handed registration, especially at the opening, while the Joplin is an embarrassingly low bow to popular taste. It suffers the most from the articulative stiffness of the computer performance. Knowlton's heart was apparently just not in it — and no denying, it is the heart behind the machine that makes or breaks the music.

• Available for \$6.95 from Computer Humanities, 2310 El Moreno St., La Crescenta, Cal. 91214 (Cal. residents add 6 percent sales tax.) — Tom Davey

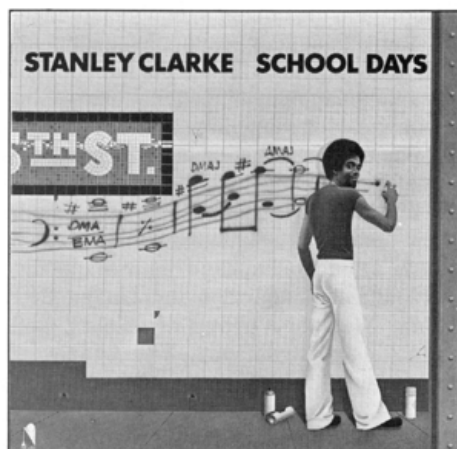

**Stanley Clarke: School Days**  
Nemperor NE 439 (Atlantic)

Stanley Clarke has two other solo albums as well as half a dozen with Return to Forever under his belt, each one better than the last, and this is no exception.

The pieces are beautiful, the playing is exquisite, the arrangements are well designed, with changes from phrase to phrase mutually complimentary. A special note in this regard is overlaying of the piccolo bass on top of the full-sized bass, resulting in a unique, and very melodic, bass sound; as well as allowing Clarke to take extended solos that would otherwise have to be a guitar or synthesizer.

Davis Sancious' synthesizer playing (Minimoog) is competent, but George Duke's (Minimoog, Odyssey) is better. Also, Billy Cobham uses his Moog 15 with his drums in a limited way that causes no damage to "Life Is Just A Game."

As far as other production techniques that master producer Ken Scott and Clarke have worked out, the digital delay fattens the sound of the bass on "Hot Fun." On "Quiet Afternoon" the doubling of the sharp-edged piccolo bass with a minimoog (with a relatively long attack time and no filter sweep) gives a unique sound because of their differing envelopes. Also, the flanger gives more presence on the piccolo bass, and in one spot, the downward sweep of the Eventide Harmonizer, a pitch changing device, allows a glissando to extend below the range of the instrument. Highly recommended.

— Danny Sofer



**George Duke: Liberated Fantasies**  
BASF/MPS G22835

The jazz/rock medium is getting to the point of maturity in that it has developed a very defined style that few people are willing to transcend. And so the difference between artists in the genre becomes a question of personality and the consequent emphasis and lack of emphasis.

It is these personal stylistic eccentricities that make George Duke unique; particularly his humor a la The Mothers (of which he is an alumnus) that comes out in the vocal overdubs in "Don't Be Shy" and in the conception of "What the . . ." a "tape piece" about the absurdities of interviews, photo sessions, etc. Sometimes Duke sounds like Stevie Wonder, sometimes Flora Purim or Stanley Clarke — or is it that they sound like him because of his playing and singing on the latter two albums? (Jan Hammer, Mahavishnu Orchestra's original keyboard player, said in an interview that his own music sounded like the Orchestra's because of the large amount of his input in the pieces, even without composer's credit.) For example, on "I C'n Hear That," there is the Frank Zappa Bass/Drums/Rhodes/single melodic line on an Odyssey, with Zappa's characteristic large interval jumps; then the subdivision of the beat changes and the piece goes through a section that could have Chick Corea playing the piano. The String Ensemble comes in and another riff is stated in a section a la Stanley Clarke, then it goes somewhere else that sounds like Joe Zawinal on a 2600. C'n you hear that?

However, the record does not sound as unfocused as this might imply. It comes off sounding only like George Duke. But the difference is subtle.

— Danny Sofer

# EQUIPMENT REVIEW

BILL MATTHIAS

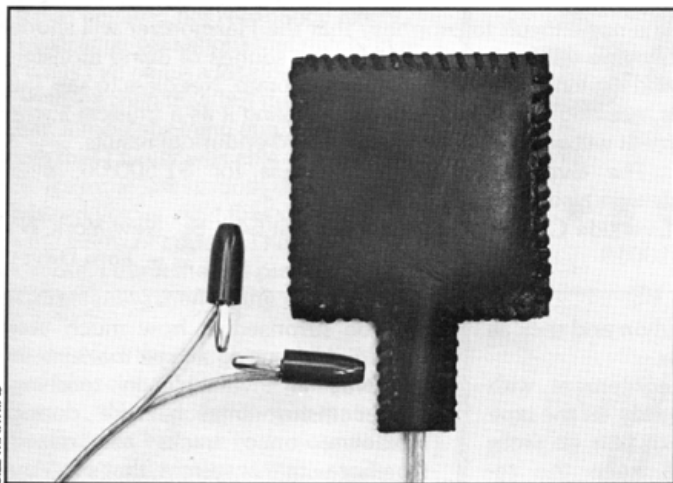

## SERGE MODULAR MUSIC FOOT PEDAL

From Serge Modular Music comes a simple but useful device — the Foot Pedal. This synthesizer accessory is in reality a signal attenuator. It works much like a VCA except the gain level is controlled by the pressure of the foot rather than a control voltage or a potentiometer.

The Foot Pedal is actually not a pedal — no moving parts, just a small, pressure sensitive pad with input and output jacks. To use the pedal a voltage must be introduced at the input. The voltage may be either discrete (up to six volts) or fluctuating. In fact any voltage profile can be controlled by the pedal, even modulation carriers. With no pressure applied the pedal is “closed”; with maximum pressure the voltage flows through unhindered. The response is smoothly linear for all degrees of pressure.

A multiplicity of uses for this device will occur to even the dull-witted. Application seems most beneficial during live performance, when hands may be busy elsewhere. Guitarists who process their instruments through synthesizers can control effects themselves at will. ARP 2600 owners now have a more responsive means of pitch bending than those clumsy knobs on the keyboard. Filter sweeps can be contoured independently of envelope generators or LFO's. The pedal can also be used to “spike” a voltage, thus providing the

pulse input to a sample and hold, for example.

The Foot Pedal cannot be used simply as a gate for audio signals. Any signal over 10kHz will leak through without applied pressure due to the capacitance of the pedal itself. Originally designed for use with the Serge Modular System, it can be interfaced with any patchable synthesizer by means of an adaptor. The Foot Pedal is available from the manufacturer for \$26; adaptor kit is \$10 extra.

Serge Modular Music, 1107½ N. Western Ave., Hollywood, Cal. 90029

— Tom Davey

## EVENTIDE HARMONIZER

Simply put, the Eventide Harmonizer is a device that transposes input signals to any interval the user selects, up and down, within two octaves. It is thus possible for an instrumentalist to play in harmony with himself, or to beef up his tone by doubling at the octave or unison. The selected interval (“pitch ratio”) can be controlled either on the Harmonizer itself, or externally: from synthesizer voltage outputs or a voltage-output keyboard. This allows the creation of melodically independent musical lines.

However, it must be admitted right off that “harmonizing” is the one thing the Harmonizer does not do entirely satisfactorily. Due to the nature of the digital circuitry used to achieve the pitch change, audio artifacts or “glitches” are introduced into the signal. (It is a problem common to all pitch change devices, by the way.) In the studio the glitches can be masked or minimized, but they rule out the use of the harmonizing function in most live and other musically naked situations.

Luckily for the Harmonizer, it has many other useful features that make it worth its weight in gold. For starters, it contains two independent signal delay outputs. Total delay can be varied over a range of 7.5 milliseconds to 112.5 ms for the first output; and up to 82.5 ms for the second. This makes it possible, among other things, to: achieve electronic reverb; achieve electronic echo; simulate room acoustics; achieve source location (through the Haas effect) and double musical signals, adding “fatness” to the sound.

A feedback control is the primary means of adding re-

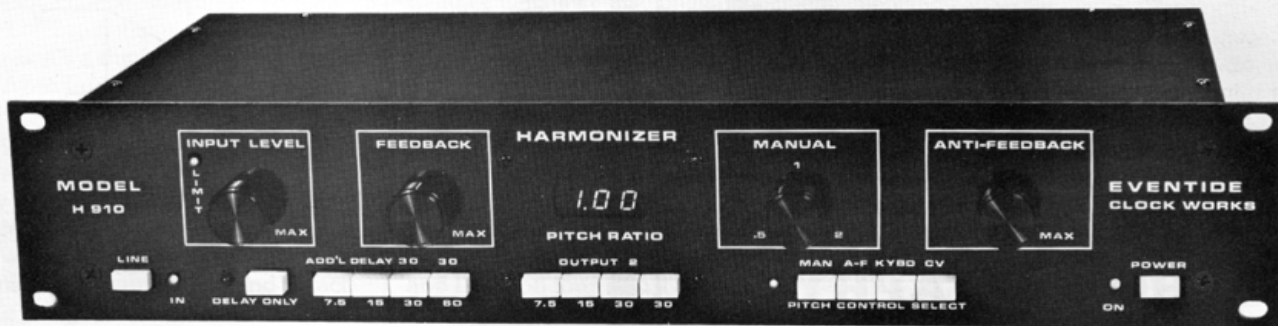

verberation. The control determines how much of the output is mixed back at the input with the original signal. Beyond a certain level, the lengthened reverb time will cause the system to oscillate upon itself, causing unusual special effects. More about special effects in a minute. The Harmonizer also possesses an "Anti-Feedback" control. By adding a small pitch oscillation to the output signal, the effect of room resonance is decreased and the incidence of unpleasant howl can be reduced.

All these controls, along with the pitch changer, are designed to be used in conjunction with one another. That is where the fun begins. We at *Synapse* (thanks to Audio Rents L.A.) spent hours at the studio recording the Harmonizer in every conceivable application and mode of operation, using

the Harmonizer to process the audio outputs of our synthesizers as well as externally controlling the functions of the Harmonizer using the synthesizers' voltage outputs. The huge number of extremely varied special effects we recorded are impossible to describe in terms of their vividness and novelty. It is not difficult to prophesy that the Harmonizer will shortly become the favorite source for the sounds of dying monsters and aspirin speeding its way to the brain. Needless to say, this is insulting to the Harmonizer. Treating it as a musical instrument will garner the most useful (and enduring) results.

The Eventide Harmonizer retails for \$1,500.00; most dealers also rent.

Eventide Clockworks Inc., 256 West 54th St., New York, NY 10019  
 — Tom Davey

## MORE 4-TRACK

FROM PAGE 9

prints onto the other track; the advantage is that your signal-to-noise ratio becomes more favorable. If you can monitor from the tape, do so to get an idea of just how much level you can put on the tape. This is highly variable from recorder to recorder and bears little, if any, relationship to the VU meter.

Another improvement is to boost the treble of instruments as they go onto the tape, as this can prevent the degradation of highs as the sounds are shuttled mercilessly from track to track. And keep a consistent recording level; overmodulation gives distortion, undermodulating gives noise. A terrible choice indeed, so learn how

much level you can put on and stick as close to that as possible.

Finally, treat the equipment with respect. Hit the keys lightly, let the tape sit for a second before you go from rewind to play, and keep the recorder(s) covered when not in use.

In actual practice, I prefer using the 3 head machine to bounce from track to track over the machine-to-machine approach. For one thing, this only involves one recorder, and if you're lucky that recorder will have a headphone monitor and a sound-on-sound control already built-in so you don't have to use a mixer or anything. For some reason I have intense cravings to spend a certain amount of time recording, and during lean times a borrowed vintage 3 head Sony provides the required solution. You

may be surprised at how much you can do. Also, using a tape machine in this way is invaluable in teaching proper instrumental balance during mixdown; once tracks are mixed together with this system, that's it. You can't go back and *unmix* them without erasing the whole thing, and you learn to be very careful.

As I said in the beginning, multi-track recorders are the way to go for high quality tapes. But often the desire exists to hear a complete musical thought, not just each part, one at a time. Under these circumstances anything goes—and if you can get four or five tracks down on tape, you'll be that much closer to translating the sounds of your mind into loudspeakers moving air.

Copyright 1976 Craig Anderton

## POP WORKS

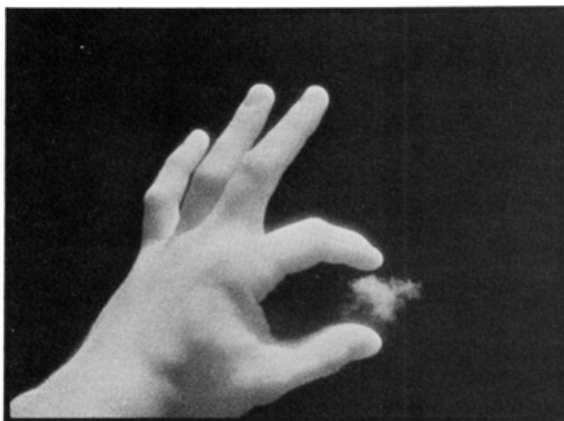

**fine arts & other fine  
 PHOTOGRAPHY  
 bill matthias - los angeles  
 213/986-3951**

and graphics  
 technical illustration

" since 1976 "

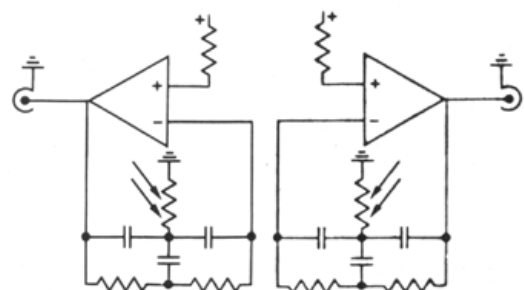

213 « 361 « 6625

1151 MACNEIL STREET  
 SAN FERNANDO « CALIFORNIA 91340

## MORE PAT GLEESON

FROM PAGE 24

her voice and put it into that series of three resonators. I created a resonance cavity that imitated her resonance cavity.

"The strange part about that patch, in a lot of ways I've come a lot closer to a human voice than that, but there is a peculiar, almost straining quality in it, an eeriness that I never was able to get before. It's must less smooth than most synthesized voices. And that's perfect; that's the sirens of course. That's what that's about. I think the last piece is a little more threatening than all the other versions."

**Sofer:** "Also, the ocean sounds seemed very close."

**Gleeson:** "My perception was that you're off shore, but you're as close as those voices would indicate. It's a sandy beach, you're at sea listening to that beach which is very close, you're just about ready to go ashore."

**Sofer:** "When I listen to an orchestral version, a lot of times the vision I get is more like being on the "Enterprise" and you're way deep in space nowhere near the water and the sirens are there but they're kind of spacey sirens rather than classical."

**Gleeson:** "You know when I started the piece, I think I was trying to make a much more astral sounding piece than I did but as I got farther and farther into it, I got more and more interested in Holst. I feel pretty certain that what I was first going to do and what I'm sure Tomita will certainly do, really is a mistake. Maybe it would have made it a more popular piece but it would have been an inaccuracy as far as the realization of that piece."

**Lynner:** "What do you think Walter Carlos has done for Electronic Music?"

**Gleeson:** "I'm a real fan of his. He was really the first guy to bring professional musical standards to any kind of a synthesized piece."

"Walter had this conception, he's always been a conceptual artist. To take Bach and realize it that way is a brilliant conception. It's a think piece as much as a piece of Alvin Lucier's; I thought "Sonic Seasoning" was stunning. I think popular music is yet to feel the full impact of that. I hear it beginning. People are now willing to pay more money for a synthesized orchestra than a real one. That's a whole change in consciousness that I think stems from Walter and in fact my whole living stems from him. When we did Lenny White's first album, his manager went through a little change

# Star track

## RECORDING STUDIO

24, 16 & 8 CHANNEL RECORDING.  
COMPLETE STATE OF THE ART  
SYNTHESIZER FACILITIES WITH  
EXPERT PROGRAMMING & ENGINEERING.

**THE STUDIO FOR THE  
TOTAL SYNTHESIST**  
AIR CONDITIONED - ADEQUATE PARKING  
24 HOUR SERVICE  
8615 SANTA MONICA BLVD.  
WEST HOLLYWOOD, CA.  
(213) 855-1171

when she found out what I wanted to orchestrate. She said she could hire a real orchestra for that amount and I said I know. She said, 'I'll have to get back to you.' She called back the next day and said, 'Lenny agrees that we could hire a real orchestra for that amount of money but he wants a synthesized orchestra.' Lenny mentioned to me that this happened and he said, 'You know, there's something about a synthesized orchestra that's more restful than a real orchestra.'

**Lynner:** "Do any of your future album plans include anything that can be toured?"

**Gleeson:** "I've got two fantasies about that. The more immediate one is that I do *Bitches Brew*. This involves Bruce Connor who is a really brilliant visual artist. I want to go to the record company and say, 'Look, here's this piece of music, you see how environmental it is?' Okay, nobody's going to pay money to listen to a tape but they will go pay money to participate in this visual environment. I mean, nobody would have dreamed that Lasarium could have been as successful as they are. So now let's package this idea and I'll go on tour with it and we'll all get rich and famous and do what we want."

**Lynner:** "Would that include any live performance?"

**Gleeson:** "That one would be completely tape. I think it would be an aspect of its austerity. It should be a very remote feel. That will limit the audience of course but I think I want to reach that audience live first. The second thing is I'm writing a concerto for Al Dimeola for guitar, synthesizer, and orchestra or guitar and synthesized orchestra."

**Sofer:** "Are there any instruments you can imagine that are not in existence at this time?"

**Gleeson:** "Well, yes. I'm working very closely with some people and it's completely their brains and my haranging demands that there be such an instrument and probably there will be such an instrument; but I can't say a word about it!" 

### ERRATA

*Synapse* offers apologies to Dick Rosmini who should have been credited for the photo of 360 Systems polyphonic guitar synthesizer on page 14 of *Synapse* #4, to Len Sasso whose name was omitted from the Electronic Music Quintet photo caption on page 22 of #4 (we should have known that a quintet has five members), and to Brian DePalma, maker of "Phantom of the Paradise," which we mistakenly credited Ken Russel.

**MORE LISTINGS  
FROM PAGE 12**

**CONSULTANTS**

BECKMAN & ASSOCIATES  
2117 Yates Ave., Los Angeles,  
Calif. 90040

ROBERT CEELY  
Boston Experimental Electronic-  
music Projects  
33 Elm St., Brookline, Mass. 02146  
(617) 731-3785

DIFFERENT FUR MUSIC  
John Vieira  
3470 19th St., San Francisco, Calif.  
94110  
(415) 863-WAVE

D.S. MUSIC  
811 Franklin Street  
Santa Monica, California 90403  
(213) 463-8772

DWIGHT D. GATWOOD  
Director, Electronics Music Studio  
University of Tennessee, Martin,  
Tennessee 38238  
(901) 584-7402, 587-2281

EMSA  
6 Webster Court, Amherst, Mass.  
01002  
(413) 256-8591

MICHAEL GILBERT  
88 Beacon Street, #14  
Somerville, Massachusetts 02143

LECTRON MUSIC LAB  
Box 1594, Hollywood, Calif. 90028

STAN LEVINE  
13508 Debell Street  
Pacoima, California 91331  
(213) 899-7223

PATCHWORK SOUND  
Jack Howe  
14759 Hesby St., Sherman Oaks,  
Calif. 91403

RON RIVERA  
48 Brighton Ave. #11, Allston,  
Mass. 02134

CARTER THOMAS  
Manpel Rd., Spring Glen, New  
York 12483  
(914) 647-9121

STAR TRACK RECORDING  
STUDIO  
8615 Santa Monica Blvd., Los  
Angeles, Calif. 90069  
(213) 855-1171

TNY MUSIC & ENGINEERING  
Route 4, Defreestville, New York  
12144  
(518) 283-2837, 283-2899

**SCHOOLS**

BOSTON SCHOOL OF  
ELECTRONIC MUSIC  
326 Dartmouth Ave., Boston,  
Mass. 02116  
(617) 261-1634

CONTEMPO MUSIC GUILD  
13273 Ventura Blvd., Studio City,  
Calif. 91604  
(213) 784-8271

DICK GROVE MUSIC  
WORKSHOPS  
12754 Ventura Blvd., Suite 2,  
Studio City, Calif. 91604

LOS ANGELES CENTER FOR  
ELECTRONIC MUSIC  
Box 1594, Hollywood, Calif. 90028  
(213) 463-8772

SOUND ARTS  
2825 Hyans St., Los Angeles, Calif.  
90026  
(213) 487-5148

SHERWOOD OAKS EXPERI-  
MENTAL COLLEGE  
6353 Hollywood Blvd., Hollywood,  
Calif. 90028  
(213) 462-0669

**CLASSIFIED ADS  
20 words for \$2.00  
to: SYNAPSE/  
Classified Ads**

**NOTE:**  
SYNAPSE has moved to  
2829 Hyans St., Los  
Angeles, California  
90026. (213) 383-7933

**Electronic Music  
Schools and Programs**

Please send a description of  
your courses, services, philoso-  
phies, and equipment status to  
Synapse. Be part of our Elec-  
tronic Music Education listing.

**SYNTHESIZER  
Programming  
Consulting  
Tracks  
... and Music**

MICHAEL GILBERT  
88 Beacon Street #14  
Somerville, Mass. 02143  
(617) 661-3332

**GLIDER by FRENCH LICK**

A fusion of space rock, elec-  
tronics and sex in the tradi-  
tion of early Pink Floyd,  
King Crimson, and Gong.

A collector's L.P. from the  
Los Angeles Underground.

Send \$5.00 to:

John Willoughby  
517 S. Palm Drive  
Brea, California 92621

*See you at Laserium,  
too!*

**Danny Sofer**

**DSMUSIC**

811 FRANKLIN ST. SANTA MONICA, CA. 90403  
213/463-8772

**lem**

**the synthesizer band**

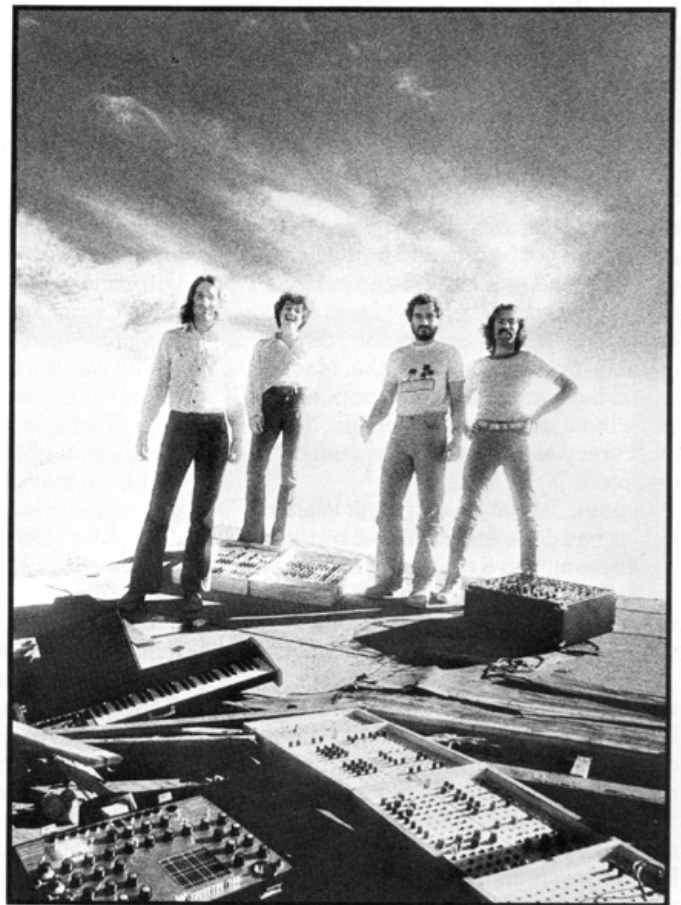

for information and booking, call or write:

**moldar productions**

8615 santa monica blvd., l.a., ca. 90069  
213/463-8772

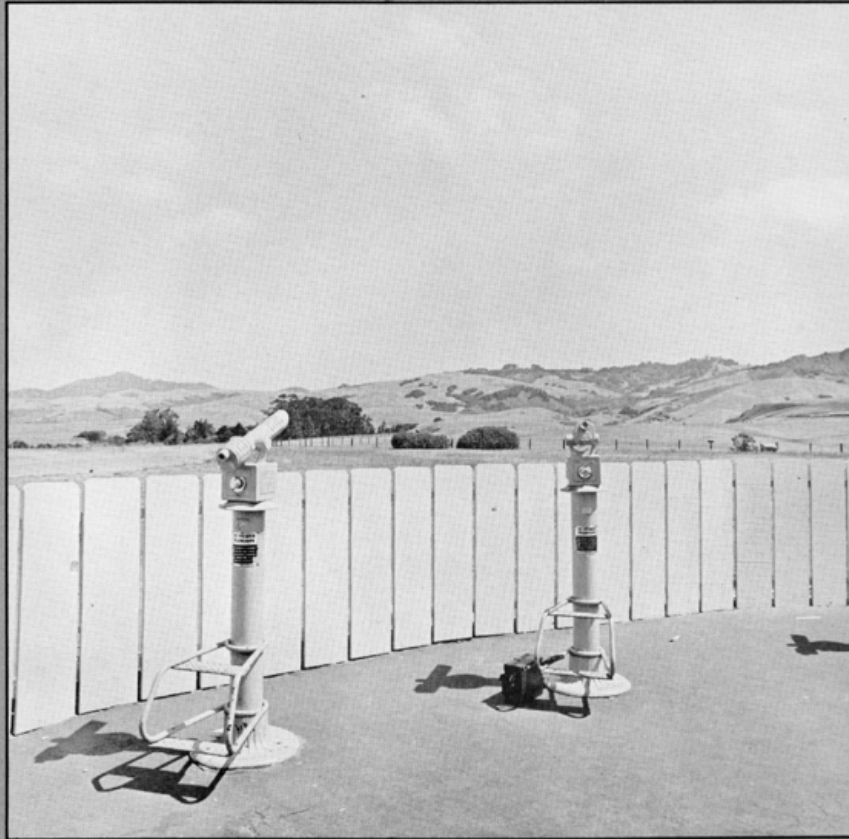

**look into Synapse**

BULK RATE  
U. S. POSTAGE  
PAID  
No. Hollywood, CA  
PERMIT NO. 456

**THIRD CLASS MAIL**

# THE ELECTRONIC MUSIC MAGAZINE

